

Modélisation numérique des interactions non-linéaires entre vagues et structures immergées, appliquée à la simulation de systèmes houlomoteurs

THÈSE

Version du mémoire provisoire,
soumise aux rapporteurs le 28 octobre 2011

soutenue publiquement le xxxxxxxxx

pour l'obtention du

Doctorat de Mécanique des Fluides

de l'Université Paris-Est

par

Etienne Guerber

Composition du jury

Rapporteurs : Pierre Ferrant, Prof., Ecole Centrale de Nantes
Bernard Molin, HDR, Ecole Centrale Marseille

Examineurs : Stéphane Abadie, Prof., Université de Pau et des Pays de l'Adour
Denis Duhamel, Prof., Ecole des Ponts ParisTech
António F. de O. Falcão, Prof., TU Lisbon - Instituto Superior Tecnico (Portugal)
Stephan Grilli, Prof., University of Rhode Island (USA)

Directeur de thèse: Michel Benoit, Prof., Ecole des Ponts ParisTech

Co-encadrant de thèse : Clément Buvat, Dr., EDF R&D

Mis en page avec la classe thloria.

Modélisation numérique des interactions non-linéaires entre vagues et structures immergées, appliquée à la simulation de systèmes houlomoteurs

Résumé

Cette thèse présente le développement d'un modèle numérique avancé, capable de simuler les interactions entre des vagues de surface de cambrure quelconque et des corps rigides immergés ayant des mouvements de grande amplitude. Fondé sur la théorie potentielle, il propose une résolution couplée de la dynamique vagues/structure par la méthode implicite de Van Daalen (1993), encore appelée méthode du potentiel d'accélération par Tanizawa (1995). La précision du modèle à deux dimensions est testée sur un ensemble d'applications impliquant le mouvement forcé ou libre d'un cylindre horizontal immergé, de section circulaire : diffraction par un cylindre fixe, radiation par un cylindre en mouvement forcé de grande amplitude, absorption des vagues par le cylindre de Bristol. Pour chaque application, les résultats numériques sont comparés à des résultats expérimentaux ou analytiques issus de la théorie linéaire, avec un bon accord en particulier pour les petites amplitudes de mouvement du cylindre et pour les vagues de faibles cambrures. La génération de vagues irrégulières et la prise en compte d'un second corps cylindrique immergé sont ensuite intégrées au modèle, et illustrées sur des applications pratiques avec des systèmes récupérateurs d'énergie des vagues simples. Enfin, le modèle est étendu en trois dimensions avec des premières applications au cas d'une sphère décrivant des mouvements de grande amplitude.

Mots-clés: Vagues non-linéaires, canal à houle numérique, dynamique de corps rigide, système récupérateur d'énergie des vagues, interactions vagues-structures.

Abstract

This PhD is dedicated to the development of an advanced numerical model for simulating interactions between free surface waves of arbitrary steepness and rigid bodies in high amplitude motions. Based on potential theory, it solves the coupled dynamics of waves and structure with the implicit method by Van Daalen (1993), also named the acceleration potential method by Tanizawa (1995). The precision of this two-dimensional model is tested on a wide range of applications involving the forced motion or free motion of a submerged horizontal cylinder of circular cross-section : diffraction by a fixed cylinder, radiation by a cylinder in specified high amplitude motions, wave absorption by the Bristol cylinder. In each of these applications, numerical results are compared to experimental data or analytical solutions based on the linear wave theory, with a good agreement especially for small amplitude motions of the cylinder and small wave steepnesses. The irregular wave generation by a paddle and the possibility to add an extra circular cylinder are integrated in the model and illustrated on practical applications with simple wave energy converters. The model is finally extended to three dimensions, with preliminary results for a sphere in large amplitude heaving oscillations.

Keywords: Nonlinear waves, numerical wave tank, rigid body dynamics, wave energy converter, wave-structure interactions.

Table des matières

1	General introduction	
1.1	General context on wave energy harnessing	1
1.2	Overview of the Wave-Body interaction problem	3
1.2.1	Interactions in wave diffraction by a fixed body	3
1.2.2	Interactions in wave radiation by a moving body, with no incident waves	4
1.2.3	Interactions in wave diffraction-radiation by a moving body under inci- dent waves	5
1.3	Organization of the manuscript	6
2	Mathematical formulation of the coupled hydro-mechanical problem	7
2.1	State of the art on numerical modelling of wave-body interactions	8
2.2	Scope of the present research and review of main assumptions	10
2.2.1	Body assumptions	10
2.2.2	Fluid assumptions	11
2.2.3	Flow assumptions	11
2.2.4	Seabed assumptions	11
2.3	Problem description	12
2.3.1	Definition of variables	12
2.3.2	Specific dimensionless numbers	13
2.3.3	Flow regimes as a function of Keulegan-Carpenter number	14
2.4	Hydrodynamic model	16
2.5	Free surface boundary conditions	17
2.6	Bottom and lateral boundary conditions	17
2.7	Body boundary conditions	18
2.7.1	Body in prescribed motion	19
2.7.2	Freely moving body	20
2.8	Summary and intermediate conclusions from the chapter	25

3	Numerical resolution in 2DV	27
3.1	Introduction and scope of the chapter	28
3.2	Discretization of the Boundary Integral Equations by BEM	29
3.3	Implicit fluid-body coupling for computation of $\partial \phi / \partial t$	29
3.4	Time integration of free surface and body boundary conditions	30
3.4.1	Time integration of free surface boundary conditions	31
3.4.2	Time integration of body motion equations	31
3.5	Summary and intermediate conclusions from the chapter	33
4	Validation of the numerical model for horizontal circular cylinders in specified motions	35
4.1	Introduction and scope of the chapter	36
4.2	Conservation of fluid volume	36
4.3	Nonlinear forces on a fixed cylinder (Chaplin, 1984)	40
4.4	Nonlinear forces on a cylinder in a specified heaving motion (Wu, 1993)	43
4.5	Nonlinear forces on a cylinder in a specified circular motion (Wu, 1993)	46
4.6	Summary and intermediate conclusions from the chapter	49
5	Validation of the numerical model for freely-moving horizontal circular cylinders	51
5.1	Introduction and scope of the chapter	52
5.2	A cylinder with a vertical elastic restoring force	52
5.2.1	Mathematical formulation of volume and energy conservation	53
5.2.2	Numerical applications	54
5.3	Comparison to the theoretical linear model of the Bristol cylinder	61
5.3.1	La théorie linéaire d'Evans	61
5.3.2	Numerical results for quasi-linear and nonlinear periodic waves	64
5.4	Comparaison à des essais en canal à houle	80
5.4.1	Présentation des essais	81
5.4.2	Modélisation du système	84
5.4.3	Prise en compte des effets visqueux dans la dynamique du système	85
5.4.4	Comparaison expériences/modèle non-linéaire	89
5.5	Summary and intermediate conclusions from the chapter	92
6	Applications à des SREVs simples en conditions de vagues irrégulières	93
6.1	Introduction et objectifs du chapitre	94
6.2	Efficacité du système en vagues irrégulières	94
6.3	Interactions entre deux cylindres absorbants	100

6.4	Résumé et conclusions intermédiaires du chapitre	106
7	Extension du modèle numérique en 3D	107
7.1	Introduction et objectifs du chapitre	108
7.2	Le bassin à houle 3D	108
7.3	Discretisation de la sphère	109
7.4	Mouvement forcé de pilonnement de grande amplitude	111
7.5	Mouvement libre de pilonnement de grande amplitude	114
7.6	Analyse des temps CPU sur les calculs 3D	116
7.7	Résumé et conclusions intermédiaires du chapitre	116
8	General conclusion and outlook	119
8.1	Summary of conclusions from this research work	119
8.2	Outlook for future research and development	120
	Table des figures	123
	Bibliographie	129

1

General introduction

1.1 General context on wave energy harnessing

Governmental policies have originally made of renewable energies and ocean energies a priority field of investigation in the late 1970's, as a consequence of the 1973 and 1979 oil crises. Impulsed by the members of the *International Energy Agency* (IEA), it was the first political interest in using ocean energies as a source of power. A particular look at wave energy and energy of currents was given at that time, with a total of 140 M USD dedicated to research and development activities by all the IEA member countries, mainly by the USA and United Kingdom [50].

More recently has ocean energy been officially declared of political interest in France by the *Grenelle Environnement* (2007) which announced the target percentage of 23% of renewable energy in the French energetic mix, as a figure to achieve in 2020. France benefits from an ideal situation, with its long coastlines in both metropolitan France and its DOM-TOM. Along the French Atlantic coast, the mean power dissipated by ocean waves has been estimated as 45 kW per meter of wave crest, which corresponds to an annual energy amount of 417 TWh, so very close to the annual electrical consumption of 476 TWh (in 2006), according to the ADEME Agency [3]. Should we remind here however that only a very small portion of this energy could be retrieved.

The various technologies for harnessing wave power are usually referred to as *Wave Energy Converters* (WECs). We usually distinguish the oscillating systems (such as the Pelamis, SEA-REV or CETO technologies), the overtopping systems (the Wave Dragon system), Oscillating Water Columns (OWCs) and other kinds of systems, as described by Cruz [23]. They transform wave power into electrical power by using at least one mechanical intermediate system : one or several floating or submerged bodies move along with waves and a power take-off system converts the relative motion between these bodies, or the relative motion between a body and the seabed, into electrical power. Choosing an appropriate and efficient conversion system is a challenging issue for many reasons : the very fluctuation of wave excitation, the need for robust materials sustainable in the ocean aggressive environment (storms, corrosion, ...), the ability of the chosen process to deliver an electrical power acceptable by a distribution network, and the environmental potential impacts (acceptability by the local population, impacts on marine life). These are the main reasons why no single technology has yet established itself as the leading device on the market. Several technologies have been proposed, and some of them were created, then tested, but only few have reached a commercial stage. Among these, the CETO technology (see e.g. [60, 16] or Carnegie website www.carnegiwave.com), a com-

mercial unit of which being shown on Fig. 1.1, uses the mechanical motion of a submerged buoy to produce high pressure water by the pumping system. This water is then driven ashore to generate electricity through a Pelton turbine. A few devices would practically be implanted on a same site, and gathered into a farm of several units.

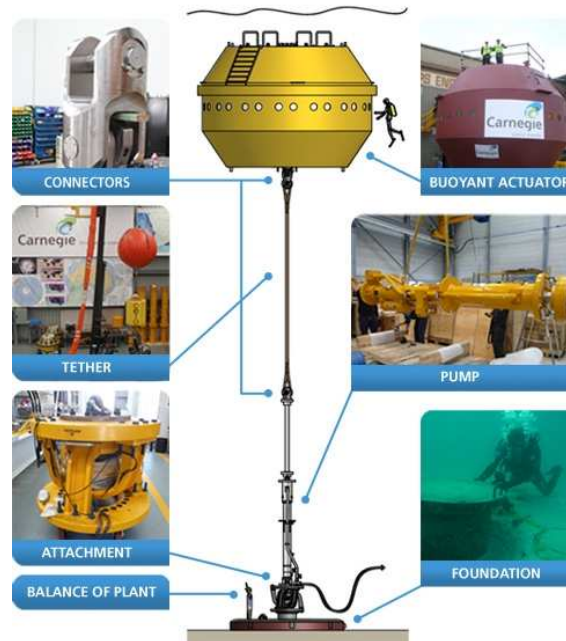

FIGURE 1.1 – CETO commercial scale unit, source : www.carnegiwave.com

This WEC has for major advantage of being totally submerged, so by being invisible from the coast, could be more easily accepted by the local population at a given test site. This kind of device, usually referred to as a point-absorber, is also designed to have its natural resonant frequency in the range of wave frequencies, in order to maximize the total absorbed power. Near resonance, the buoy will describe large amplitude motion. Other technologies could also be mentioned, but due to the lack of space in this work, the reader is referred to the work by Cruz and co-authors [23] for a general overview of the different types and their classification.

One challenge of wave energy research is to provide numerical tools able to simulate these technologies in the ocean environment, as realistically as possible. Various scales of modelling can be adopted, such as unit scale, farm scale or regional scale. In this work, we focus on the modelling of one or two single WECs, and the farm scale approach will not be tackled here (see [14] for the numerical modelling of a farm of several units).

The conventional mathematical way of modelling a single WEC is based on the linear wave theory which assumes that waves are of small amplitude, relative to both wavelength and water depth, and that the associated amplitude of motion of the involved structures is small as well. These assumptions set the base for an extensive analytical work inspired by the field of ship hydrodynamics and offshore structures. Among the pioneering works, the reader is referred to the analytical approach of Newman [63]. Subsequently, benefiting from the advances in computational mechanics, various numerical codes were built to simulate the behaviour of more complex structures submitted to linear waves, such as *WAMIT* (MIT, [2]), *Diodore* (Principia, [10]), and *Achil3D* [21] and *Aquaplus* [26] (Ecole Centrale de Nantes).

These tools, based on the assumptions of the linear wave theory, solve the body motion equations, for a body submitted to incident regular or irregular waves. They provide the user with the displacement of the center of mass of the anchored structure in its various degrees of freedom, at a given wave frequency ω . However, as explained below, results obtained with these tools remain valid in the range where both wave steepness and structure displacement are small, which is not verified *a priori* with point-absorbers in large amplitude motions, in particular near their resonance period.

1.2 Overview of the Wave-Body interaction problem

In this part, we briefly describe the physical interactions which take place when a submerged moving rigid body is submitted to incident regular waves of frequency ω . One way to solve this *a priori* complex problem is the classical approach, based on the linear wave theory, which consists in splitting the problem into two simpler problems : the *diffraction* problem where the body remains fixed under incident waves and the *radiation* problem where the body oscillates at frequency ω in each degree of freedom, under a free surface initially at rest. In each case, the hydrodynamic forces on the body are evaluated and finally superimposed into the body motion equations. Both time-domain resolution and frequency domain resolution can be used to compute the body displacement resulting from a wave excitation at frequency ω . This diffraction-radiation decomposition is hereafter adopted to describe the interactions involved in both problems, with an emphasis on the limits of the linear approach.

1.2.1 Interactions in wave diffraction by a fixed body

In case of a fixed body submitted to incident waves, the body is submitted to the hydrodynamic pressure force, called the *excitation force* (see Fig. 1.2).

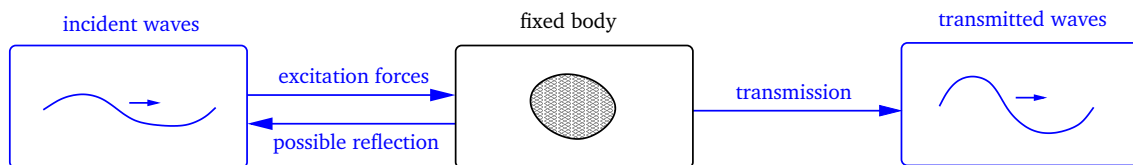

FIGURE 1.2 – Illustration of the diffraction problem : physical interactions between incident waves and a fixed body. Depending on the shape of the body and the nature of incident waves, these can be altered by the structure, resulting in modified transmitted waves. Reflected waves may also interact with incident waves (if nonlinear effects are accounted for).

Based on the linear wave theory, various formulations of this force were proposed, whose intensity is proportional to the incident wave amplitude. For further details, the reader is referred to the original works of Newman [63] and Haskind [46]. In the linear approach, only the component at the wave frequency is modelled. However, when the shape of the body disturbs significantly the incident flow, higher order interactions might happen between the waves and body. In case of a fixed body submerged close to the free surface or incident waves of relatively high steepness, wave shoaling may occur, which might result in breaking at the top of body. In this case, higher order terms in the excitation form should be taken into account. Depending on the shape of the structure, reflected waves may also be generated which will

propagate backwards and interact with incident waves. For the case of the horizontal circular cylinder, Dean [24] first showed analytically that, according to linear wave theory, incident waves in deep water suffer a phase shift when passing over a submerged circular cylinder, but their height is not modified. Also, waves are not reflected from the cylinder. Later, Ogilvie [65] extended these results to the second order.

1.2.2 Interactions in wave radiation by a moving body, with no incident waves

We here consider an oscillating body at frequency ω , submerged under the free surface initially at rest, with no incident waves. This case is illustrated on Fig. 1.3 for a body in a purely heaving oscillation.

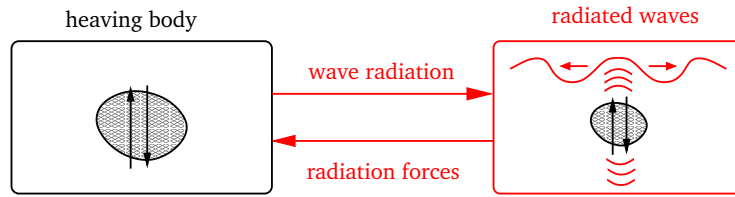

FIGURE 1.3 – Illustration of the radiation problem : physical interactions between a heaving body and the radiated waves. The body is submitted to the radiation forces, due to waves created by its own motion.

According to the linear wave theory and assuming a small amplitude of body motion, waves of frequency ω are generated and propagate at infinity. As a consequence, this transported momentum exerts in return a hydrodynamic force on the rigid body, called the *radiation force*, which, according to the linear wave theory, has two components : one proportional and opposite to the body acceleration \ddot{x} and the other, proportional and opposite to the body velocity \dot{x} , such as,

$$\mathbf{F}_{rad} = -a(\omega)\ddot{x} - b(\omega)\dot{x} \quad (1.1)$$

where $a(\omega)$ is the linear added-mass and $b(\omega)$ is the linear radiation damping of the body at the frequency ω . These coefficients depend mostly on ω , the shape of the body, its submergence depth, the water depth, and the mode of motion. Examples of this radiation force will be computed in chapter 5, section 5.3.2, for the case of a circular cylinder in forced heaving motion, in order to have access to the hydrodynamic coefficients in heave $a(\omega)$ and $b(\omega)$. The numerically obtained coefficients will be compared to referenced values in the literature, obtained through linear wave assumptions. Now, if the body oscillates at frequency ω in a large amplitude motion, its motion generates an infinite number of waves with frequencies $n\omega$ ($n=1, 2, \dots$) (see [80]), which will propagate at different velocities and interact between each other.

1.2.3 Interactions in wave diffraction-radiation by a moving body under incident waves

This is the case of incident waves passing above a submerged WEC, which is modelled by a freely-moving body, anchored to the seabed with a linear anchoring system. We assume that there is no interaction between the anchoring system and the surrounding flow, and that this system is of negligible mass. Based on the assumptions of small wave steepness and small amplitude of body motion, the linear theory allows to superimpose the excitation and radiation forces, previously introduced, into the body motion equations. In the linear approach, body motion equations are solved with a time-domain or frequency-domain resolution to compute the displacement of the body center of mass, when excited at the frequency ω .

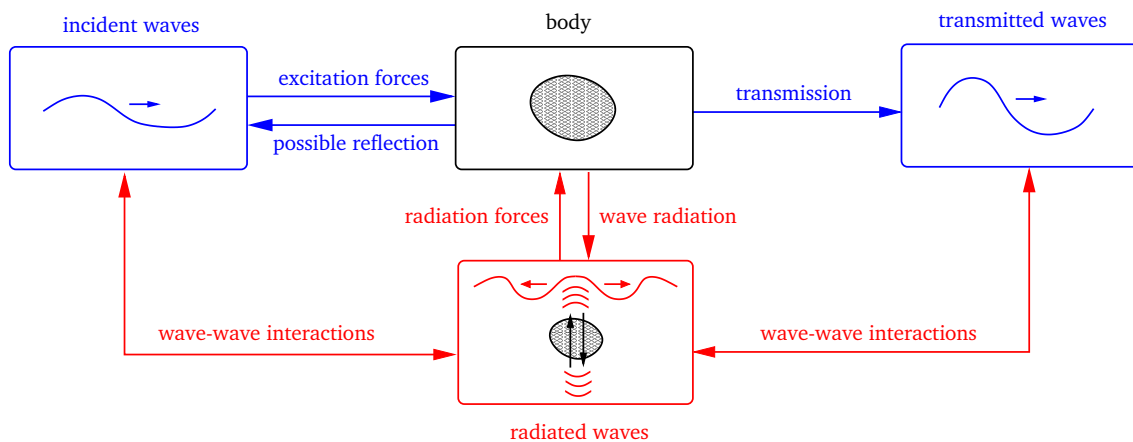

FIGURE 1.4 – Illustration of the physical interactions in wave diffraction (blue) and radiation (red) by a heaving body under incident waves. Two wave-wave interactions between radiated waves and both incident and transmitted waves have to be taken into account.

Now in the general situation illustrated on Fig. 1.4, some physical interactions might be neglected in the linear approach. As a matter of fact, if incident waves pass along a moving body, both diffraction and radiation occur, so the radiated waves will not only interact with the body through the radiation force, but also with incident and transmitted waves. These additional wave-wave interactions can appear at higher orders for a body in large amplitude motion, and could not be described using the linear potential theory. These could also modify the physical properties (wave height, frequency) of incident and transmitted waves, which would in return modify the body dynamics, impacting the radiated waves and so on. Also, depending on the phase shift between the incident waves and the body displacement, wave shoaling of incident waves can be reinforced as compared to the case of a fixed body, or on the contrary, the incident waves can be absorbed. If the body gets very close to the free surface, we may also assume that this interaction will be reinforced, a situation which could force waves to break at the top of the structure. When dealing with WECs such as point-absorbers, one of the major challenge is to calibrate the linear anchoring system parameters so that the motion of the body is in phase with waves, in order to maximize the amount of absorbed energy. Evans [27] and Evans et al. [28] (see chapter 5) analytically showed that, under the linear wave theory assumptions, 100% of incident wave energy can be absorbed by a submerged circular cylinder if the power take-off parameters are specifically adjusted. Now,

if the anchoring system were nonlinear, the dynamical response of the body would take place at a different frequency than the wave excitation. In this case, a nonlinear approach would be inevitable.

Furthermore, if one wishes to use and implement control strategies on the motion of the body, in order to optimize the amount of energy extracted from the incident wave field, such as the latching technique (see e.g. [7]), a time-domain modelling approach is required.

Based on this simple qualitative analysis, two important considerations are drawn : a nonlinear approach seems necessary to assess the higher-orders wave-body and wave-wave interactions, which might happen for waves with a high steepness and/or for large amplitudes of body motion. Moreover, a *coupled fluid-structure* approach, able to solve simultaneously the fluid and body motions, may also better represent the actions and feedbacks between the waves and the body than the linear approach which only models the wave action onto the body.

1.3 Organization of the manuscript

In this work, a coupled modelling of wave-body nonlinear interactions is presented, based on the Fully Nonlinear Potential Flow (FNPF) theory. In chapter 2, the main scientific assumptions at the basis of the modelling are stated, along with an introduction of the important physical quantities of the problem. From these assumptions, the mathematical formulation of the wave-body coupling is derived. Chapter 3 describes the numerical implementation of the time marching scheme, with a focus on the time integration algorithm of body position and velocity. Chapter 4 presents various numerical applications involving the prescribed motion of a submerged horizontal cylinder of circular cross-section, with comparisons to other experimental or analytical approaches. Chapter 5 describes various applications, also with a submerged horizontal cylinder of circular cross-section, but this time restrained by a vertical elastic restoring force and/or a linear damping force, in one or two degrees of freedom. Validation of the numerical model is performed with comparisons to Evans analytical first-order theory [27], or experimental approaches. Chapter 6 is dedicated to the modelling of simple wave energy converters in irregular waves, with two applications : the study of the influence of the peak enhancement parameter γ of the generated JONSWAP spectra on the efficiency of a single device, and the study of the influence of the separation distance between two identical devices on their respective efficiency, and on the global efficiency. Finally, chapter 7 presents the preliminary numerical simulations obtained in three dimensions with a submerged sphere describing large amplitude heaving motions.

2

Mathematical formulation of the coupled hydro-mechanical problem

Ce chapitre formule de façon mathématique le problème couplé hydro-mécanique. On rappelle les différentes approches numériques utilisées jusqu'à présent, ainsi que les hypothèses physiques sur le fluide et le corps faites dans notre approche. Les principales grandeurs du problèmes sont aussi définies. On s'attache ensuite à décrire les équations mathématiques du problème hydro-mécanique non-linéaire, en particulier les conditions aux limites à la surface du corps suivant que ce dernier décrit un mouvement forcé ou libre. Le principe mathématique de la méthode retenue pour le couplage est finalement détaillé.

Contents

2.1 State of the art on numerical modelling of wave-body interactions	8
2.2 Scope of the present research and review of main assumptions	10
2.3 Problem description	12
2.4 Hydrodynamic model	16
2.5 Free surface boundary conditions	17
2.6 Bottom and lateral boundary conditions	17
2.7 Body boundary conditions	18
2.8 Summary and intermediate conclusions from the chapter	25

2.1 State of the art on numerical modelling of wave-body interactions

The increase in computational power along the past thirty years has played a major role in the development of various numerical techniques for simulating wave-body interactions, reinforced by an ever growing need from the community of naval engineers for faster and more accurate results. These techniques may be classified into two main families :

- approaches based on the potential flow theory,
- approaches based on Navier-Stokes equations.

Due to the heavy computational effort required by the latter ones, these are more often used only in the field of research. As an example, one can mention the work by Tavassoli and Kim [74, 75], who used the Finite Element Method (FEM) to compute the nonlinear interactions of waves with a moving or fixed submerged circular cylinder. The Reynolds Average Navier-Stokes (RANS) equations are more used in ship hydrodynamics, for example by Azcueta [5], to simulate turbulent free-surface flows around ships and floating bodies.

Attention is paid now to the various approaches based on potential flow theories, widely used in industrial and research numerical tools, which describe the irrotational flow of an incompressible and inviscid fluid (all the assumptions will be recalled in the following section) surrounding a rigid body. They may be separated into two sub-families : the linear and fully nonlinear wave-body approaches. Numerical models based on the linear wave theory were first introduced so that the motions of floating or submerged bodies with complex geometries could be simulated, in response to linear incident waves. Various three-dimensional tools of these are still widely used for their good computational speed propriety. All based on the Boundary Element Method (BEM), we refer here to the tools Aquaplus (Ecole Centrale de Nantes, [26]), Diodore (Principia, [10]) and WAMIT (MIT, [2]), for a frequency-domain resolution, and Achil3D (Ecole Centrale de Nantes, [21]) for a time-domain resolution. They provide the user with the hydrodynamic coefficients of the considered body, as well as its displacements in response to wave excitation in its six degrees of freedom. WAMIT has also options for second- or third-order computations [2].

As explained by Tanizawa [73], Fully Nonlinear Potential Flow (FNPF) theory was later used to develop numerical models referred to as Numerical Wave Tanks (NWTs), which is a generic name for numerical simulators of nonlinear free surface waves, hydrodynamic forces and freely-moving bodies. Their final goal is to reproduce physical wave tanks as closely as possible. First developments were done by Longuet-Higgins and Cokelet [58] who introduced the well-known Mixed Eulerian-Lagrangian (MEL) method, where Eulerian field equations are solved to obtain fluid velocity, and the obtained velocity is used to track fluid particles on the free surface in a Lagrangian way. The MEL method lies at the basis of many NWTs which were developed to compute fully nonlinear free surface motions in time domain, for the first time. Among them, Grilli et al. [38] proposed a two-dimensional NWT to simulate the generation and absorption of nonlinear periodic waves, using a High-Order Boundary Element Method (HOBEM). Zhang et al. [85] focused on the propagation of solitary, irregular and incident waves with a Desingularized Boundary Element Method (DBEM). Three-dimensional (3D) NWTs were also developed : Grilli et al. [37] modelled overturning waves over an arbitrary bottom, and Bai and Eatock-Taylor [8] computed the wave diffraction by a vertical cylinder and used a domain decomposition technique to reduce the computational effort.

The simulation of unrestrained bodies, freely-moving under the action of incident waves, later appeared in the literature, following the pioneering work of Vinje and Brevig [79] who introduced in 1981 the acceleration field in order to determine the pressure distribution and resulting body acceleration simultaneously. Other similar techniques were proposed after this one, and will be briefly described in subsection 2.7.2 of the present chapter. Cointe [22] and Tanizawa were among the firsts in 1990 to simulate two-dimensional body motions in waves, followed by Van Daalen [78]. Koo and Kim [54, 55, 56] developed a two-dimensional approach to simulate free-surface-piercing bodies, either fixed, moving in a prescribed motion or freely-floating. 3D-NWTs were first developed by Berkvens [11] in a cylindrical tank with a damping zone applied along its circumference. Ikeno [49] simulated the transient motion of a moored barge in regular wave, while Shirakura et al. [68] computed the free heaving motion of a sphere. Bai and Eatock-Taylor [9] also extended their 3D-NWT for the coupled simulation of nonlinear waves interacting with a vertical truncated cylinder.

NWTs based on the FPNF theory classically use the Boundary Element Method (BEM) in one version or another : Constant Panel Method (CPM), High-Order Boundary Element Method (HOBEM), or Desingularized Boundary Element Method (DBEM), also called the Method of Fundamental Solutions (MFS). Very few simulations of nonlinear wave-body interactions are based on the High-Order Spectral (HOS) method, and the work by Kent and Choi [53] is here to be notified. Other approaches coupling two numerical methods are rarely yet encountered. Among them, Thomas [76] proposed in his doctoral research in 1997 an original two-dimensional model combining a HOS representation of the free surface with a BEM representation of the body, applied to the diffraction, radiation and coupled radiation-diffraction of incident waves by a circular cylinder. In 2003, Wu and Eatock-Taylor [82] studied a coupled FEM-BEM approach, splitting the computational domain in three zones, two zones with BEM-based computations and the middle zone surrounding the body with an FEM-based computation for Navier-Stokes equations. Finally, one can also mention the SWENSE method [32, 59], developed at Ecole Centrale de Nantes, which permits to couple a potential flow solver applied at a large scale with a RANS solver applied locally in the surrounding of the body.

The present work is based on the 2D-NWT and 3D-NWT originally developed by Grilli and his collaborators, in which the coupled wave-body resolution has been implemented. At the end of the present chapter (see sub-section 2.7.2), various techniques for coupling wave and body dynamics, in the range of the nonlinear potential flow theory, will be recalled and the chosen method will be further described.

2.2 Scope of the present research and review of main assumptions

The present work is dedicated to the numerical modelling of one or several submerged bodies submitted to the action of ocean waves. Fig. 2.1 is an example of the considered situation, for a 2DV (two-dimensional in the vertical plane) case, with the denomination of the three body degrees of freedom for 2DV cases,

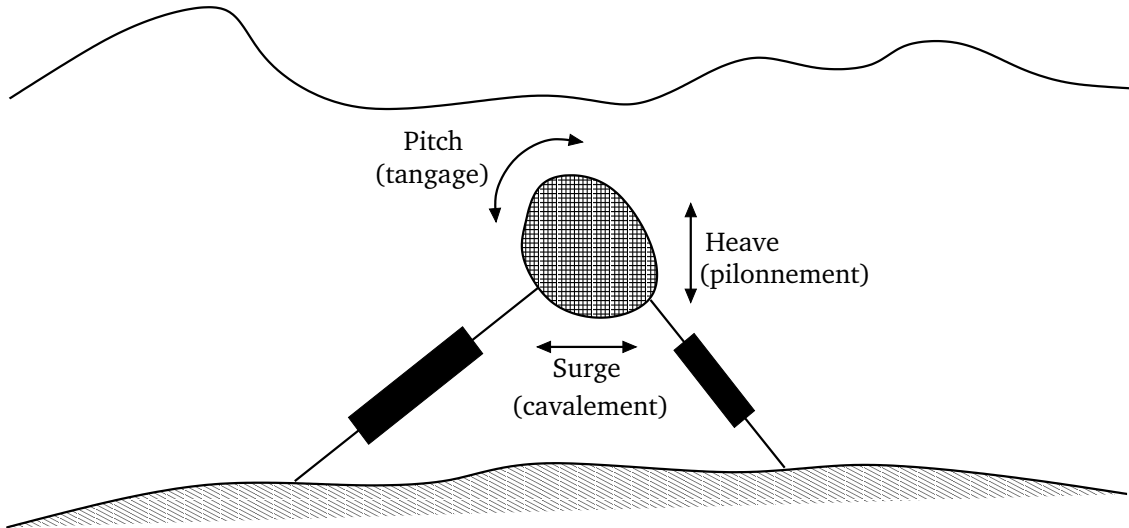

FIGURE 2.1 – Scheme of the considered situation, here in 2DV : a totally submerged and rigid body, moving under the action of ocean waves and various external forces.

The present research takes place within the framework of the Fully Non-linear Potential Flow (FNPF) theory for the description of the hydrodynamics, combined with rigid body dynamics for the mechanical behaviour of the structure. Accordingly, we assume various hypotheses regarding the bodies, fluid, flow and bottom, which are stated and discussed below.

2.2.1 Body assumptions

All the bodies are always assumed :

- (H1) strictly rigid,
- (H2) homogeneous,
- (H3) totally submerged under the free surface.
- (H4) the anchoring system which links the body to the seabed is assumed to have no impact on the hydrodynamics around the body, and its potential influence will always be neglected throughout the following work.

The body can be of any shape in the general situation but in the present work, only bodies with simple shapes are considered : horizontal cylinders of circular cross-section in 2D, and spheres in 3D. There is no further restriction on the amplitude of motion of the body.

2.2.2 Fluid assumptions

The fluid is assumed :

- (H5) homogeneous of density ρ ,
- (H6) inviscid.

As a result of (H5), the flow is always incompressible. Consequently to (H6), internal viscous friction is neglected, as well as viscous forces on the body. However a viscous drag can be added to the body dynamics through a specific formulation. This will be discussed and applied in chapter 5, section 5.4.

2.2.3 Flow assumptions

- (H7) The flow is assumed irrotational.
- (H8) We consider non-overtopping waves, whereas the numerical model used in the following work can deal with breaking waves up to the point where the jet impacts the free surface (for further details, see e.g. [37]).

Note that there is no restriction on the type of waves or on their non-linearity.

2.2.4 Seabed assumptions

- (H9) We will consider only finite water depths, given that targeted applications (WECs) are located in nearshore or coastal areas. Some cases will however consider large water depths, so that the deep water assumption applies.
- (H10) The bathymetry can be of arbitrary shape, although in most cases, a flat bottom will be used mainly for simplicity reasons.

As a result of (H6), there is no boundary layer on the bottom, so no energy dissipation due to bottom friction.

2.3 Problem description

As illustrated on Fig. 2.2, we consider in this section the simple case of a two-dimensional submerged circular cylinder mounted on a vertical power take-off system and interacting with incident monochromatic waves. Various physical parameters are introduced, as well as dimensionless numbers, useful for the description of the wave-structure interactions.

2.3.1 Definition of variables

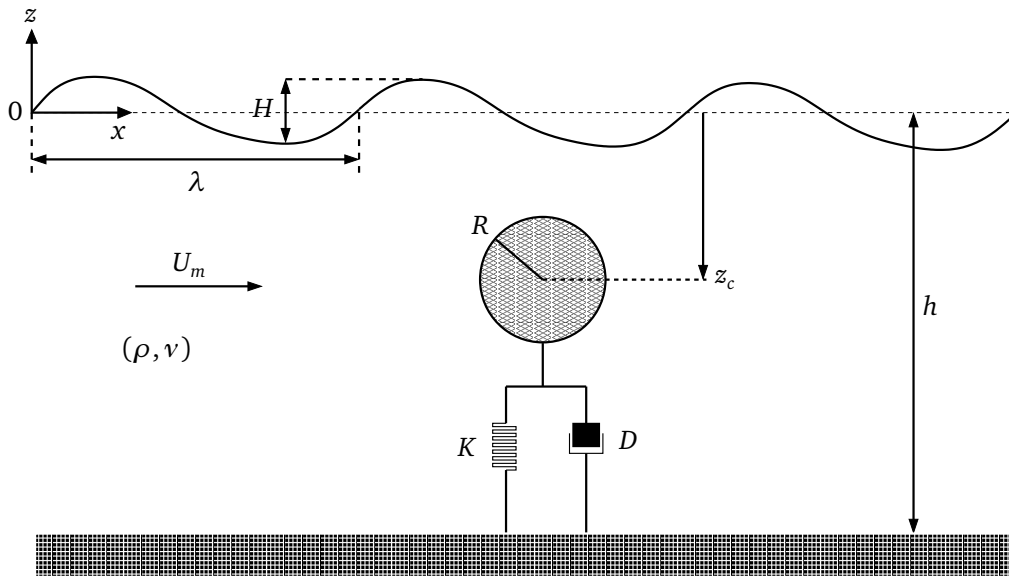

FIGURE 2.2 – A two-dimensional submerged circular cylinder interacting with incident monochromatic waves, and physical variables used to describe the fluid, waves, cylinder and anchoring system.

- the fluid is characterized by :
 - the water depth h (m),
 - its density ρ (kg/m³),
 - its kinematic viscosity ν (m²/s).
- In case of regular waves, these are described by :
 - the wave height (crest to trough) H (m) and wave amplitude $A = H/2$ (m),
 - the wavelength λ (m) and wavenumber $k = 2\pi/\lambda$ (m⁻¹),
 - the maximum orbital horizontal velocity U_m (m/s) and vertical velocity W_m (m/s) of the flow beneath waves, at a given position.

In case of monochromatic waves, the parameters of periodicity in time - period T (s), frequency f (Hz) or angular frequency $\omega = 2\pi f = 2\pi/T$ (rad/s) - can be determined by the dispersion relation, provided the wavelength λ or wavenumber k , the water depth h and the wave height H in the general situation. In the following, we will make use of the linear dispersion relation (2.1) to obtain λ (or k) from T (or f , or ω) and h :

$$\omega^2 = gk \tanh(kh) \quad (2.1)$$

- The submerged rigid cylinder is characterized by :
 - its radius R (m) or diameter $2R$ (m),
 - its mass M (kg in 3D, and kg/m in 2DV),
 - the submergence depth z_c (m) of its center of mass.
- The anchoring system and power take-off mechanism which in most cases, link the body to the bottom with a spring and damping system. We define here :
 - the spring of stiffness K (N/m=kg/s² in 3D, and N/m²=kg/s²/m in 2DV) acts on the body with an elastic restoring force proportional to the distance between the body and its equilibrium position :

$$\mathbf{F} = -K(\mathbf{x} - \mathbf{x}_0) \quad (2.2)$$

- the damping system of damping coefficient D (N.s/m=kg/s in 3D, and N.s=kg/m/s in 2DV), acts as a force proportional and opposed to the body velocity, such as :

$$\mathbf{F} = -D\dot{\mathbf{x}} \quad (2.3)$$

2.3.2 Specific dimensionless numbers

Using the previously defined dimensional quantities, one usually defines the following dimensionless numbers :

- **The relative water depth kh or h/λ**
 The relative water depth gives information about the length of the waves as compared to the water depth. Long waves with $kh < \pi/10$ or $h/\lambda < 1/20$ are considered as non-dispersive, whereas short waves with $kh > \pi$ or $h/\lambda > 1/2$ are considered as deep water waves, and one usually considers that the flow induced by these waves is not influenced by the bottom.
- **The wave steepness kH , kA or H/λ**
 The wave steepness is used to characterize the degree of nonlinearity of waves : for small wave steepnesses $H/\lambda < 0.01$, waves are quasi-linear and sinusoidal whereas waves of steepness $H/\lambda > 0.01$ are considered nonlinear and their shape can not be reduced to a simple sinusoid. Beyond the commonly used value of $H/\lambda \approx 0.14$, wave breaking occurs for deep water waves.
- **The Ursell number $U_s = H\lambda^2/h^3 = (\frac{H}{h})/(\frac{h}{\lambda})^2$**
 The Ursell number is another parameter used to describe the nonlinearity of long waves ($kh < \pi/10$). Apart from a constant $3/(32\pi^2)$, it corresponds to the ratio of the amplitudes of the second order to the first order term in the free surface elevation. For long waves with $U_s \ll 100$, linear wave theory is applicable. Otherwise a nonlinear theory has to be used.

- **The Reynolds number** $Re = \frac{2U_m R}{\nu}$
The Reynolds number was originally introduced to define the flow regime around a fixed structure in a steady current of uniform velocity U . As for the oscillatory flow induced by waves, we consider here the corresponding Reynolds number where U_m stands for the maximum flow velocity in a wave period T .
- **The relative submergence depth** $k|z_c|$ or $|z_c|/\lambda$
The relative submergence depth, similarly to the relative water depth, compares the wavelength to the water height above the cylinder at rest. Waves may thus be short compared to h , but long compared to the submergence depth $|z_c|$.
- **The Keulegan-Carpenter number** $Kc = \frac{U_m T}{2R}$
The Keulegan-Carpenter number is a dimensionless parameter which has an important influence on the oscillatory flow regime around the structure, as explained below.

2.3.3 Flow regimes as a function of Keulegan-Carpenter number

Main results for the influence of the Keulegan-Carpenter number Kc on the flow regime are presented hereafter, in a qualitative way. These are obtained from Molin [62] and Sumner and Fredsøe [71]. A more detailed study of this parameter, based on an analytical and experimental approach, can be found in Sarpkaya [66].

If the flow is sinusoidal with a horizontal velocity at the elevation of the body given by $U = U_m \sin(\omega t)$ and $U_m = a\omega$, where a is the amplitude of the motion, Kc is therefore identical to $Kc = 2\pi a/2R = \pi a/R$. Small Kc numbers mean that the orbital motion of the water particles is small relative to the characteristic dimension of the cylinder.

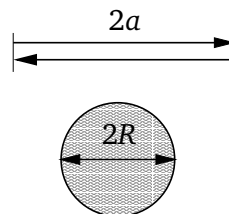

FIGURE 2.3 – Kc is the ratio of the amplitude a of the orbital motion to the diameter $2R$ of the cylinder (from [71]).

When the amplitude of motion of water particles is large relatively to the diameter, a wake with vorticity appears behind the cylinder during a half period of wave, a flow similar to the observed one with a cylinder in a steady current. After a half period, the wake comes back at the cylinder, and vorticity and turbulence diffuse into the fluid [62]. This phenomenon can only be modelled considering the fluid viscosity and using the Navier-Stokes equations. However, when the Kc number is relatively small, water particles do not travel sufficiently far compared to the cylinder diameter for the boundary layer to separate from the body. The order of magnitude of this boundary layer thickness is $\sqrt{\nu/\omega}$, which is about 1 to 2 mm, for wave periods $T = 5$ to 20 s. This is certainly negligible in most practical cases [62]. At a given Kc , the transition between a separated and a non-separated flow is governed by the Reynolds number. Fig. 2.4 illustrates how the boundaries between the flow regimes vary as a function of Re and Kc , for small Kc numbers ($Kc < 3$) [71].

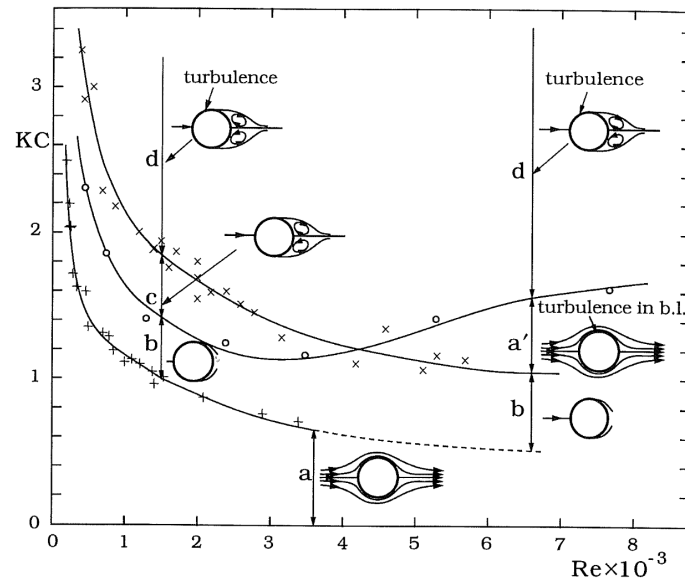

FIGURE 2.4 – Regimes of flow around a circular cylinder in oscillatory flow for small Kc numbers ($Kc < 3$) (Sumer and Fredsøe, [71]). Circles are obtained from Sarpkaya's experiments [66]; crosses for $Re < 1000$ from Honji [48] and crosses for $Re > 1000$ from Sarpkaya [66]. This diagram is taken from Sumer and Fredsøe [71], who previously adapted it from Sarpkaya [66].

On Fig. 2.4, the area marked "a" corresponds to a non-separated flow, while in "a'", the boundary layer becomes turbulent. The flow in "b" is a transition state where vortex shedding begins while in "c", a steady pair of symmetric vortices is located behind the cylinder. "d" is the same as "c" but with turbulence at the cylinder boundary, due to a higher Reynolds number. Note that this analysis assumes a fixed structure. When dealing with moving bodies with an amplitude large or comparable to their own dimensions, such as Wave-Energy Converters (WECs), the Reynolds and Keulegan-Carpenter numbers should be expressed as a function of the relative velocity between the fluid and the body. The transition between the flow regimes illustrated on Fig. 2.4 might still be valid only when the body velocity remains negligible compared to the fluid velocity.

Based on these considerations, our modelling of wave interactions with submerged bodies assumes that the structures have their dimensions greater to comparable to the wavelength, a situation which corresponds to small Kc numbers. We will consider Kc numbers from 0.05 to 1.50. Also, in order to neglect the role of turbulence, we consider in the following work, only flows of relatively small Re numbers, typically $Re < 8000$. Working with small Kc numbers has for major consequence that the incident waves will, locally at least, be disturbed by the presence of the body, even when this body remains fixed.

2.4 Hydrodynamic model

For all the wave-structure interaction problems discussed here, a three-dimensional (3D) Cartesian coordinate system (x, y, z) is chosen, with the z -axis oriented vertically upwards and with $z = 0$ in the plane of the undisturbed free surface. For purely two-dimensional problems in the vertical plane (2DV), the dependence on y will be omitted and throughout, time is denoted by t . Fig. 2.5 shows, as an example, the 2DV problem of a circular cylinder submerged beneath waves.

The computational domain Ω is the fluid domain, enclosed by the free surface boundary Γ_f , lateral boundaries Γ_{r1} and Γ_{r2} , the bottom boundary Γ_b and the body boundary Γ_c . On each boundary is defined a 3D curvilinear coordinate system with a direct local basis $(\mathbf{s}, \mathbf{m}, \mathbf{n})$, with \mathbf{n} pointing outside of the fluid domain. In 2DV situations, this system reduces to (\mathbf{s}, \mathbf{n}) .

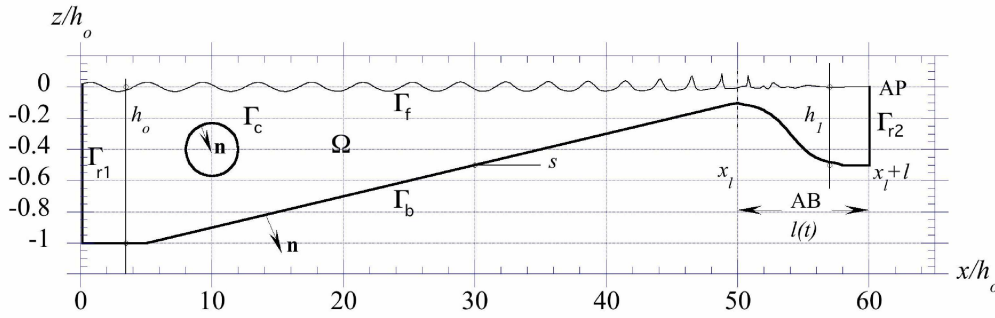

FIGURE 2.5 – Sketch of computational domain Ω of 2DV-NWT, and its boundaries Γ_f , Γ_{r1} , Γ_{r2} , Γ_b and Γ_c .

As a consequence of the irrotational character of the flow (H7), the fluid velocity \mathbf{u} may be expressed as the gradient of a scalar velocity potential $\phi(\mathbf{x}, t)$, that is $\mathbf{u} = \nabla\phi$, where $\mathbf{u} = (u, v, w)$ in 3D cases and $\mathbf{u} = (u, w)$ in 2DV cases.

Mass conservation combined with hypothesis (H5) requires that the divergence of the velocity is zero (the flow is incompressible) so that ϕ satisfies Laplace equation in the fluid domain $\Omega(t)$, with boundary $\Gamma(t)$,

$$\Delta\phi = 0 \quad \text{in } \Omega(t) \quad (2.4)$$

We also define $\phi_t \equiv \partial\phi/\partial t$ the Eulerian time derivative of the potential, and it is straightforward to show from Eq. (2.4) that ϕ_t also satisfies a second Laplace equation,

$$\Delta\phi_t = 0 \quad \text{in } \Omega(t) \quad (2.5)$$

Both equations will be solved numerically at each time step, as will be explained in the following. Accurate values of ϕ_t are needed both to compute second-order terms in the time-integration of the free surface boundary geometry and potential, and for specifying boundary conditions on submerged moving bodies. In the former, using ϕ_t and its spatial derivatives ensures a higher accuracy and stability, thereby eliminating the need for filtering or smoothing on the free surface. In the latter, ϕ_t allows computing the pressure p along the body boundary $\Gamma_c(t)$, which depends on ϕ_t . As will be detailed later, this is key to dealing with freely moving bodies with high amplitude motion. As reported by several authors (e.g., [22, 54]), using

backward finite difference schemes to compute ϕ_t is not sufficiently accurate and leads to numerical instabilities.

The solution of Laplace equations (2.4) and (2.5) requires well-posed Dirichlet-Neumann boundary conditions, which are detailed in the next subsections.

Note, for simplicity, in the following, all partial derivatives of the potential will be indicated by subscripts. For example, ϕ_n will stand for $\partial\phi/\partial n = \nabla\phi \cdot \mathbf{n}$ and ϕ_{tn} for $\partial^2\phi/\partial t\partial n$.

2.5 Free surface boundary conditions

On the free surface $\Gamma_f(t)$, ϕ satisfies the kinematic and dynamic boundary conditions,

$$\frac{D\mathbf{r}}{Dt} = \mathbf{u} = \nabla\phi \quad \text{on } \Gamma_f(t) \quad (2.6)$$

$$\frac{D\phi}{Dt} = -gz + \frac{1}{2}\nabla\phi \cdot \nabla\phi - \frac{p_a}{\rho} \quad \text{on } \Gamma_f(t) \quad (2.7)$$

respectively, with the lagrangian derivative of a function f defined as $\frac{Df}{Dt} = \left(\frac{\partial}{\partial t} + \mathbf{u} \cdot \nabla\right) f$. \mathbf{r} is the position vector on the free surface, $\mathbf{r} = (x, y, z)$ in 3D cases and $\mathbf{r} = (x, z)$ in 2DV cases, g is the gravitational acceleration, z the vertical coordinate, p_a the atmospheric pressure at the free surface, and ρ the fluid density. Using Eqs. (2.6) and (2.7) to integrate in time the free surface position and the free surface potential ϕ^f , a Dirichlet boundary condition on $\Gamma_f(t)$ can be specified for the Laplace problem (2.4) for ϕ ,

$$\phi = \phi^f \quad \text{on } \Gamma_f(t) \quad (2.8)$$

Once the latter is solved, Eq.(2.7) yields a Dirichlet boundary condition on $\Gamma_f(t)$ for the Laplace problem (2.5) for ϕ_t ,

$$\phi_t = \phi_t^f = -gz - \frac{1}{2}\nabla\phi \cdot \nabla\phi - \frac{p_a}{\rho} \quad \text{on } \Gamma_f(t) \quad (2.9)$$

2.6 Bottom and lateral boundary conditions

Along the stationary bottom Γ_b , a no-flow condition is prescribed as a homogeneous Neumann condition for both problems for ϕ and ϕ_t ,

$$\phi_n = 0 \quad \text{and} \quad \phi_{tn} = 0 \quad \text{on } \Gamma_b \quad (2.10)$$

On the leftward boundary of the NWT, Γ_{r1} , periodic or irregular waves are generated by an oscillating piston or flap wave-maker. An exact wave generation for periodic progressive waves, based on the stream-function wave theory, can also be specified, together with a zero-mass flux condition [38]. On the rightward side of the tank, an absorbing beach (AB) is implemented to reduce wave reflection from the far end boundary Γ_{r2} . Thus, an artificial counteracting pressure is applied over a given distance in the dynamic free surface condition (Eq. (2.7)), which creates a negative work against incident waves. In addition, a piston-like absorbing boundary condition, first introduced by Clément [20], is specified on boundary Γ_{r2} . These methods of generation and absorption of waves lead to Dirichlet or Neumann boundary conditions for the two Laplace problems. They will not be detailed here. For more information, see Grilli and Horrillo [38].

2.7 Body boundary conditions

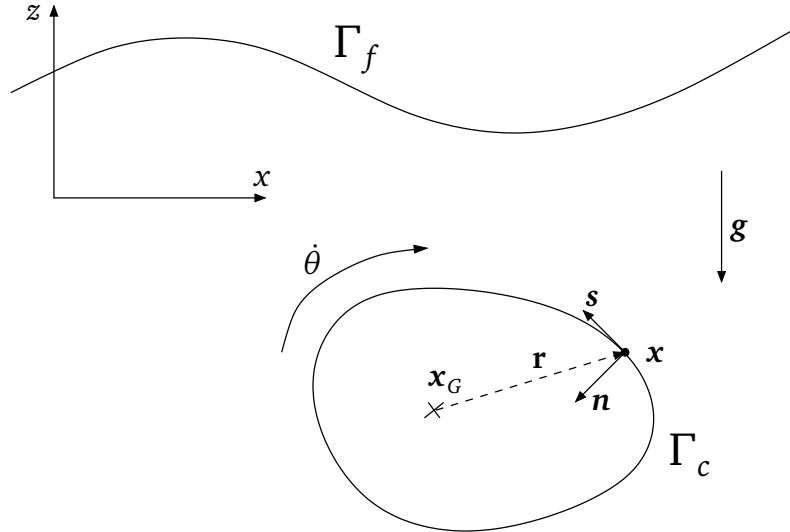

FIGURE 2.6 – Definition of mathematical symbols used to describe the two-dimensional rigid body boundary Γ_c submerged under the free surface Γ_f .

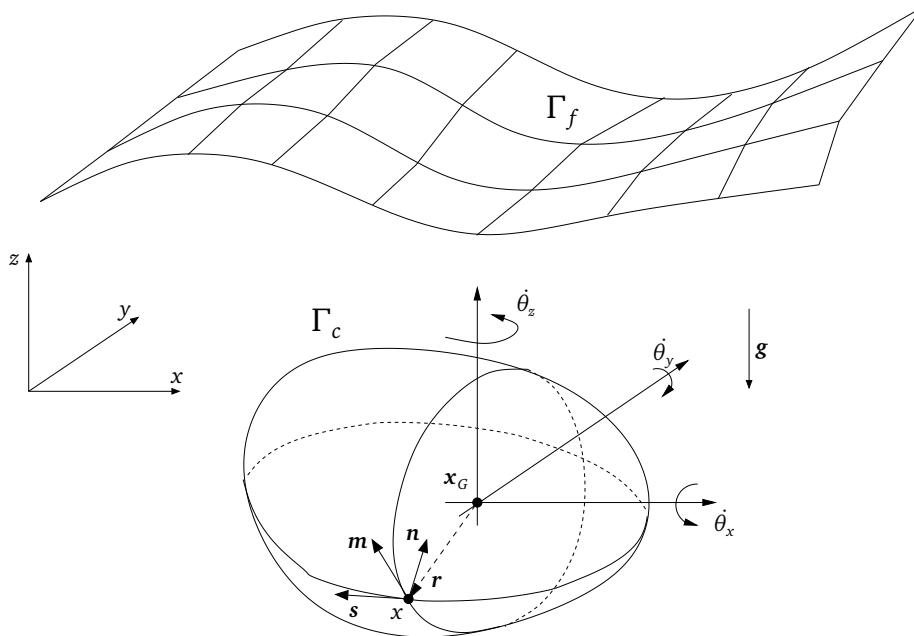

FIGURE 2.7 – Definition of mathematical symbols used to describe the three-dimensional rigid body boundary Γ_c submerged under the free surface Γ_f .

The 2DV-NWT and 3D-NWT originally developed by Grilli et al. were modified to include totally submerged rigid bodies, under the free surface, as illustrated on Fig. 2.6 for a two-dimensional body and on Fig. 2.7 for a three-dimensional body. In the three-dimensional case, the body has six degrees of freedom, three of translation $\mathbf{x}_G = (x_G, y_G, z_G)$ and three of rotation $\boldsymbol{\theta} = (\theta_x, \theta_y, \theta_z)$ around the three fixed axis passing through its center of mass. Every point \mathbf{x} of the body boundary is determined by its local curvilinear coordinates with direct basis $(\mathbf{s}, \mathbf{m}, \mathbf{n})$ with \mathbf{n} pointing inside the body. We also define the radius vector $\mathbf{r} = \mathbf{x} - \mathbf{x}_G$. In the two-dimensional case, the body has only three degrees of freedom, two of translation (surge and heave) $\mathbf{x}_G = (x_G, z_G)$ and one of rotation (pitch) θ (see Fig. 2.1).

In the following, we consider various body boundary conditions depending on its type of motion. Two situations are successively considered, the case of a body : (i) in prescribed motion (including the case of a fixed body) ; and (ii) undergoing “free” motion (under the effects of various forces applied to it). Boundary conditions for each case are detailed next for the general three-dimensional problem.

2.7.1 Body in prescribed motion

When the body motion is specified, the boundary condition on the body surface is simply expressed as a Neumann condition for the potential :

$$\phi_n = \dot{\mathbf{x}} \cdot \mathbf{n} \quad \text{on } \Gamma_c(t) \quad (2.11)$$

where $\dot{\mathbf{x}}$ is the velocity for points on the body boundary, which is known when the motion of the body is prescribed.

Another Neumann condition for ϕ_{tn} is specified on the body boundary, to solve for ϕ_t . Following Cointe [22], Grilli and Svendsen [42], Van Daalen [78], or Tanizawa [72], this reads,

$$\phi_{tn} = \ddot{\mathbf{x}} \cdot \mathbf{n} + v(\mathbf{x}) \quad \text{on } \Gamma_c(t) \quad (2.12)$$

with v , a local quantity defined at point \mathbf{x} of the body boundary $\Gamma_c(t)$, expressed here for 3D problems as,

$$\begin{aligned} v(\mathbf{x}) = & (\dot{\mathbf{x}} \cdot \mathbf{m} - \phi_m) \dot{\boldsymbol{\theta}} \cdot \mathbf{s} - (\dot{\mathbf{x}} \cdot \mathbf{s} - \phi_s) \dot{\boldsymbol{\theta}} \cdot \mathbf{m} \\ & - \left(\frac{1}{R_m} \phi_m + \phi_{mn} \right) \dot{\mathbf{x}} \cdot \mathbf{m} - \left(\frac{1}{R_s} \phi_s + \phi_{sn} \right) \dot{\mathbf{x}} \cdot \mathbf{s} \\ & + \left(\phi_{mm} + \phi_{ss} - \left(\frac{1}{R_m} + \frac{1}{R_s} \right) \phi_n \right) \dot{\mathbf{x}} \cdot \mathbf{n} \end{aligned} \quad (2.13)$$

where $1/R_m$ and $1/R_s$ are the local curvature of the body boundary in the two tangential directions with $(\mathbf{m}, \mathbf{s}, \mathbf{n})$ being the local vectors (see Fig. 2.7), $\dot{\mathbf{x}}$ and $\ddot{\mathbf{x}}$ are the velocity and acceleration of the point \mathbf{x} of Γ_c , respectively, and $\dot{\boldsymbol{\theta}} = (\dot{\theta}_x, \dot{\theta}_y, \dot{\theta}_z)$ is the angular velocity vector as defined on Fig. 2.7. For 2DV problems Eq. (2.13) simplifies as,

$$v(\mathbf{x}) = (\dot{\mathbf{x}} \cdot \mathbf{s} - \phi_s) \dot{\theta} - \left(\frac{1}{R} \phi_s + \phi_{sn} \right) \dot{\mathbf{x}} \cdot \mathbf{s} + \left(\phi_{ss} - \frac{1}{R} \phi_n \right) \dot{\mathbf{x}} \cdot \mathbf{n} \quad (2.14)$$

where $1/R$ is the local curvature of the boundary, \mathbf{n} and \mathbf{s} are the local normal and tangential vectors, and $\dot{\theta}$ is the body angular velocity, as defined on Fig. 2.6. Boundary conditions

(Eqs. (2.11) and (2.12)) are similar to the boundary conditions specified for the generation of waves by a flap-type wave-maker [34, 38]. Various results in two-dimensions will be presented in chapter 4 for a submerged circular cylinder in forced vertical and circular motions.

2.7.2 Freely moving body

This is the case of a loosely tethered or slackly moored submerged body subjected to wave action. In this case, the body kinematics needed in Eqs. (2.11-2.13) is not *a priori* known. Hence, $\dot{\mathbf{x}}$, $\ddot{\mathbf{x}}$ and $\dot{\boldsymbol{\theta}}_G$ must be computed by solving a coupled fluid-structure interaction problem, in which equations for the fluid and body motion are simultaneously solved. In this case, Eq. (2.12) also cannot be directly used as an explicit boundary condition to solve the Laplace problem for ϕ_t , but first needs to be formulated differently.

Assuming a three-dimensional body of mass M and moment of inertia $\mathbf{I} = (I_x, I_y, I_z)$ about the three axes passing through the body's center of mass G , the dynamic equations governing body motion read,

$$M\ddot{\mathbf{x}}_G = \int_{\Gamma_c} p\mathbf{n} d\Gamma + M\mathbf{g} + \mathbf{F}_{ext} \quad (2.15)$$

$$\mathbf{I} \otimes \ddot{\boldsymbol{\theta}} = \int_{\Gamma_c} p(\mathbf{r} \times \mathbf{n}) d\Gamma + \mathbf{M}_{ext} \quad (2.16)$$

where $\ddot{\mathbf{x}}_G$ is the body center of mass acceleration, \mathbf{F}_{ext} is the resultant of applied external forces, which essentially damp body motion (e.g., viscous drag, mooring, power take-off,...), \mathbf{M}_{ext} the resulting moment of those forces about the center of mass. \mathbf{r} is the position of a point on the body boundary with respect to the center of mass and \mathbf{n} is the normal vector pointing inside the body, as seen on Fig. 2.7. We define here the component-wise vector product and division such as,

$$\mathbf{a} \otimes \mathbf{b} = (a_x b_x, a_y b_y, a_z b_z) \quad (2.17)$$

$$\mathbf{a} \oslash \mathbf{b} = \left(\frac{a_x}{b_x}, \frac{a_y}{b_y}, \frac{a_z}{b_z} \right) \quad (2.18)$$

Finally, in Eqs. (2.15)-(2.16), pressure p along the body boundary is given by the (non-linear) Bernoulli equation,

$$p = -\rho \left(\phi_t + \frac{1}{2} \nabla \phi \cdot \nabla \phi + gz \right) \quad (2.19)$$

The main difficulty for computing this pressure is that both ϕ_t and ϕ_{tn} are unknown at any given time along $\Gamma_c(t)$, since these depend on body motion. Several strategies have been proposed to overcome this difficulty, which are briefly presented in the following.

Review of the various strategies

As described by Koo and Kim [54], four methods have been proposed to solve the coupled fluid-structure interaction problem :

- a *mode decomposition method* first proposed by Vinje and Brevig [79] and then used by Cointe [22] and Koo and Kim [54],
- the *iterative method* of Sen [67] and Cao et al. [17]
- the *indirect method* of Wu and Eatock-Taylor [81],
- the *implicit method* of Van Daalen [78] and Tanizawa [72].

In all these methods, the potential ϕ and its normal derivative ϕ_n are obtained in the computational domain $\Omega(t)$ as solutions of a Laplace problem with explicit Dirichlet-Neumann boundary conditions on $\Gamma(t)$ at each time step. Apart from the *indirect method* by Wu and Eatock-Taylor [81] which yields directly the body motion accelerations at each time step, all the above-cited methods rely on achieving a precise computation of the time derivative of the potential ϕ_t , which plays an important role in the formulation of the pressure in Eq. (2.19) : several authors [54, 22] highly recommend to avoid the use of backward finite difference schemes to compute ϕ_t , a scheme which would lead to numerical instabilities, especially for bodies in large amplitude motions. An overview of these four main strategies is given hereafter.

The *mode decomposition method* was proposed and used by Vinje and Brevig [79] in their 2DV-NWT. It was also used by Cointe [22] and Koo and Kim [54], also in 2DV cases. In their 2DV-NWT, the time derivative of the potential ϕ_t is computed based on a linear decomposition “into four modes corresponding to three unit accelerations for sway-heave-roll and acceleration due to the velocity field. Each mode can be obtained by solving the respective boundary integral equation” (Koo and Kim, [54]). These four modes are computed at every iteration and lead to a value of ϕ_t . The pressure p can be integrated along the wet part of the body boundary with Eq. (2.19). The body motion equations (2.15) and (2.16) yield the body accelerations, and body displacement and velocity can be time-integrated to the next time step. The main drawback of such an approach is the need to solve four boundary integral equations at every iteration, one for each mode, only to obtain ϕ_t . This method would inevitably result in a time-consuming algorithm.

Another method called the *iterative method*, used by Sen [67] and Cao et al. [17], is based on a predictor-corrector loop to converge on the value of the body accelerations at the current time step. The body accelerations $\ddot{\mathbf{x}}_G$ and $\ddot{\boldsymbol{\theta}}$ at the current time step are first estimated, based on their values at the previous time steps. Using the Neumann condition for ϕ_{tn} stated in Eq. (2.12), so can ϕ_t be computed as a solution of a Laplace problem with explicit boundary conditions. The hydrodynamic pressure forces and moments give the body accelerations through body motion equations (2.15) and (2.16). These are compared to their initially estimated values and the process is repeated until convergence is reached for both $\ddot{\mathbf{x}}_G$ and $\ddot{\boldsymbol{\theta}}$. At the end, body displacement and velocity are time-integrated to the next time step. This approach may also be time-consuming, even though less than the *mode decomposition method* if convergence is reached in one iteration. However, as opposed to the other methods, body motion equations are not strictly verified, but only up to an arbitrary order of convergence. Choosing a lower convergence criterion would inevitably require a higher number of iterations

and a larger CPU time.

The *indirect method* was introduced by Wu and Eatock-Taylor [81] in 3D and used by Kashiwagi in its 2DV-NWT [51]. As opposed to the other methods, this one does not need the solution of ϕ_t . An artificial “potential” vector ψ is introduced, which has one component for each degree of freedom. Each of its component ψ_i is defined as a solution of the Laplace equation, along with specific Dirichlet-Neumann boundary conditions (which do not depend on ϕ or ϕ_t). Using Green’s second identity, the i^{th} -component of the hydrodynamic forces and moments can be expressed as a function of ψ_i , its normal derivative and apart from known quantities, the body accelerations. By injecting this relation into body motion equations, Wu and Eatock-Taylor draw a relation between the body accelerations and the potentials ϕ and ψ , and their spatial derivatives. To process the coupled resolution, every iteration, once the potential ϕ and each component ψ_i are computed as solutions of their respective Laplace problems, body accelerations are directly obtained using the previously mentioned relation. This method is clearly more efficient than the *mode decomposition method* which has one additional Laplace problem to solve at each time step. However, since ϕ_t is not explicitly calculated, the hydrodynamic pressure cannot be obtained.

Finally, the *implicit method* proposed by Van Daalen [78], also called the *acceleration potential method* by Tanizawa [72], uses the body motion equations (2.15) and (2.16) in order to yield an extra boundary integral equation which links ϕ and its normal derivative ϕ_{tn} on the body boundary. This relation is added to the Laplace problem for ϕ_t so that the number of equations equals the number of unknowns. By integrating the pressure along the body boundary, the body displacement and velocity are time-integrated to the next time step.

Further details about these four methods and their mathematical formulation can be seen in the above-cited references and in Koo and Kim [54]. The following table illustrates for each method the number N_L of Laplace problems that need to be solved at each time step, for both 2DV and 3D cases, including the Laplace problem for ϕ .

The *implicit method* is apparently less time-consuming than the other methods, since only two Laplace problems are required at each time step, for both 2DV and 3D problems. No artificial potential must to be introduced and the hydrodynamic pressure is explicitly calculated, once ϕ_t computed. We therefore decided to choose this method for its relative simplicity and efficiency. It will be presented in the following. Its mathematical formulation will be derived hereafter and its numerical implementation will be described in the following chapter (see chapter 3, section 3.3).

method	authors	artificial potential	N_L	
			2DV	3D
<i>mode decomposition</i>	Vinje and Brevig, Cointe, Koo and Kim [79, 22, 54]	yes	5	8
<i>iterative</i>	Sen, Cao et al. [67, 17]	no	$1 + i$	$1 + i$
<i>indirect</i>	Wu and Eatock-Taylor, Kashiwagi, Koo and Kim [81, 51, 54]	yes	4	7
<i>implicit</i>	Van Daalen, Tanizawa [78, 72]	no	2	2

TABLE 2.1 – Comparison of the methods used to solve the coupled fluid-structure interaction problem, in the scope of the fully non-linear potential flow theory. N_L is the number of Laplace problems to solve at each time step, including the one for the potential ϕ . For the *iterative method*, the number i stands for the number of iterations required for convergence on body accelerations at each time step ($i \geq 1$).

The implicit method

The implicit method is selected here, as it does not require iterations and there is no need to introduce any artificial potential. The principle of it is to express an additional relation between ϕ_t and ϕ_{tn} along $\Gamma_c(t)$, on the basis of the rigid body kinematics assumed by hypothesis (H1), which provides a relationship between $\ddot{\mathbf{x}}$, $\ddot{\mathbf{x}}_G$ and $\ddot{\boldsymbol{\theta}}$,

$$\ddot{\mathbf{x}} = \ddot{\mathbf{x}}_G + \ddot{\boldsymbol{\theta}} \times \mathbf{r} + \dot{\boldsymbol{\theta}} \times (\dot{\boldsymbol{\theta}} \times \mathbf{r}) \quad (2.20)$$

Replacing $\ddot{\mathbf{x}}$ from Eq. (2.20) into Eq. (2.12) yields

$$\phi_{tn}(\mathbf{x}) = \ddot{\mathbf{x}}_G \cdot \mathbf{n} + (\ddot{\boldsymbol{\theta}} \times \mathbf{r}) \cdot \mathbf{n} + [(\dot{\boldsymbol{\theta}} \cdot \mathbf{r}) \dot{\boldsymbol{\theta}} - \|\dot{\boldsymbol{\theta}}\|^2 \mathbf{r}] \cdot \mathbf{n} + \nu(\mathbf{x}) \quad (2.21)$$

where we used the identity $\mathbf{a} \times (\mathbf{b} \times \mathbf{c}) = (\mathbf{a} \cdot \mathbf{c})\mathbf{b} - (\mathbf{a} \cdot \mathbf{b})\mathbf{c}$. $\|\cdot\|$ states for the euclidean norm, defined as $\|\mathbf{a}\|^2 = a_x^2 + a_y^2 + a_z^2$.

Now, substituting into Eq. (2.21) the expressions of the accelerations given by Eqs. (2.15) and (2.16) gives

$$\begin{aligned} \phi_{tn}(\mathbf{x}) = \int_{\Gamma_c} p_\xi \left[\frac{1}{M} (\mathbf{n} \cdot \mathbf{n}_\xi) + (\mathbf{r} \times \mathbf{n}) \cdot ((\mathbf{r}_\xi \times \mathbf{n}_\xi) \otimes \mathbf{I}) \right] d\Gamma_\xi \\ + [(\dot{\boldsymbol{\theta}} \cdot \mathbf{r}) \dot{\boldsymbol{\theta}} - \|\dot{\boldsymbol{\theta}}\|^2 \mathbf{r} + \mathbf{g}] \cdot \mathbf{n} + \nu(\mathbf{x}) \\ + \frac{1}{M} \mathbf{F}_{ext} \cdot \mathbf{n} + (\mathbf{r} \times \mathbf{n}) \cdot (\mathbf{M}_{ext} \otimes \mathbf{I}) \end{aligned} \quad (2.22)$$

where we used the identity $\mathbf{a} \cdot (\mathbf{b} \times \mathbf{c}) = (\mathbf{a} \times \mathbf{b}) \cdot \mathbf{c}$. In the first term of Eq. (2.22), p_ξ , \mathbf{r}_ξ and \mathbf{n}_ξ stand for the pressure, radius vector and normal vector, respectively, at the integration point ξ on the body boundary.

Replacing the pressure p with its expression given by the Bernoulli equation (2.19), one obtains the implicit boundary integral equation as derived independently by Van Daalen [78] and Tanizawa [72] :

$$\phi_{tn}(\mathbf{x}) + \int_{\Gamma_c} K(\mathbf{x}, \xi) \phi_t(\xi) d\Gamma_\xi = \gamma(\mathbf{x}) \quad \text{on } \Gamma_c(t) \quad (2.23)$$

in which the kernel function $K(\mathbf{x}, \xi)$ is regular and symmetric and only depends on the rigid body geometry (i.e., is valid for all times),

$$K(\mathbf{x}, \xi) = \rho \left[\frac{1}{M} \mathbf{n}(\mathbf{x}) \cdot \mathbf{n}(\xi) + (\mathbf{r}(\mathbf{x}) \times \mathbf{n}(\mathbf{x})) \cdot ((\mathbf{r}(\xi) \times \mathbf{n}(\xi)) \otimes \mathbf{I}) \right] \quad (2.24)$$

and,

$$\begin{aligned} \gamma(\mathbf{x}) = - \int_{\Gamma_c} \left[\frac{1}{2} \nabla \phi_\xi \cdot \nabla \phi_\xi + g z_\xi \right] K(\mathbf{x}, \xi) d\Gamma_\xi \\ + [(\dot{\boldsymbol{\theta}} \cdot \mathbf{r}) \dot{\boldsymbol{\theta}} - \|\dot{\boldsymbol{\theta}}\|^2 \mathbf{r} + \mathbf{g}] \cdot \mathbf{n} + \nu(\mathbf{x}) \\ + \frac{1}{M} \mathbf{F}_{ext} \cdot \mathbf{n} + (\mathbf{r} \times \mathbf{n}) \cdot (\mathbf{M}_{ext} \otimes \mathbf{I}) \end{aligned} \quad (2.25)$$

Eqs. (2.15) to (2.25) are the governing equations of a freely moving body, totally or partially submerged under the free surface.

2.8 Summary and intermediate conclusions from the chapter

We have successively described the mathematical formulation of two different problems : (i) a submerged body in a prescribed motion and (ii) a submerged freely-moving body submitted to wave action and other external forces. In both cases, the potential ϕ and its time derivative ϕ_t are solution of Laplace equations (2.4) and (2.5), with various Dirichlet or Neumann boundary conditions.

In the case (i) of a body in a prescribed motion, the potential ϕ is solution of the following boundary value problem,

$$\Delta\phi = 0 \text{ in } \Omega(t), \text{ with } \begin{cases} \phi = \phi^f & \text{on } \Gamma_f(t) \\ \phi_n = 0 & \text{on } \Gamma_b \\ \text{specific BCs} & \text{on } \Gamma_{r1} \text{ and } \Gamma_{r2} \\ \phi_n = \dot{\mathbf{x}} \cdot \mathbf{n} & \text{on } \Gamma_c(t) \end{cases} \quad (2.26)$$

whereas ϕ_t is solution of the boundary value problem,

$$\Delta\phi_t = 0 \text{ in } \Omega(t), \text{ with } \begin{cases} \phi_t = -gz - \frac{1}{2}|\nabla\phi|^2 - \frac{p_a}{\rho} & \text{on } \Gamma_f(t) \\ \phi_{tn} = 0 & \text{on } \Gamma_b \\ \text{specific BCs} & \text{on } \Gamma_{r1} \text{ and } \Gamma_{r2} \\ \phi_{tn} = \ddot{\mathbf{x}} \cdot \mathbf{n} + v(\mathbf{x}) & \text{on } \Gamma_c(t) \end{cases} \quad (2.27)$$

where the kinematics $\dot{\mathbf{x}}$ and $\ddot{\mathbf{x}}$ of the solid point \mathbf{x} is explicitly known at the body boundary $\Gamma_c(t)$, due to the prescribed motion. The function $v(\mathbf{x})$ is defined by Eqs. (2.13) and (2.14) respectively for 3D and 2DV problems.

In the case (ii) of a freely-moving body submitted to wave action and other external forces, the potential ϕ is again solution of the Laplace problem (2.26), with the body velocity $\dot{\mathbf{x}}$ being obtained from the time integration of body accelerations. The time derivative of the potential is computed using the *implicit method* proposed by Van Daalen [78] and Tanizawa [72]. As a result, ϕ_t is solution of a similar boundary value problem as (2.27), but for which the implicit integral relation (2.23) replaces the explicit body boundary condition (2.12), which is summarized as,

$$\Delta\phi_t = 0 \text{ in } \Omega(t), \text{ with } \begin{cases} \phi_t = -gz - \frac{1}{2}|\nabla\phi|^2 - \frac{p_a}{\rho} & \text{on } \Gamma_f(t) \\ \phi_{tn} = 0 & \text{on } \Gamma_b \\ \text{specific BCs} & \text{on } \Gamma_{r1} \text{ and } \Gamma_{r2} \\ \phi_{tn} + \int_{\Gamma_c} K\phi_t d\Gamma = \gamma & \text{on } \Gamma_c(t) \end{cases} \quad (2.28)$$

The well-posedness of such problems, meaning the existence and uniqueness of a solution, has been treated in many books and papers. This will not be discussed here and for a general overview of these results, the reader is referred to Van Daalen [78]. In the following, we suppose that each boundary value problem is well-posed.

These problems are numerically solved with the High-Order Boundary Element Method (HOBEM), whose implementation is described in chapter 3. Various applications for the cases of a circular cylinder in prescribed motions and for the case of a freely-moving circular cylinder will then be shown in chapters 4, 5 and 6. Chapter 7 will address the case of a 3D body (sphere).

3

Numerical resolution in 2DV

La résolution numérique du problème hydro-mécanique couplé en deux dimensions est explicitée dans ce chapitre. On rappelle les principes de la méthode des éléments de frontière pour la discrétisation des équations intégrales. On s'intéresse à la résolution du problème sur ϕ_t dans le cas d'un corps libre et à l'intégration en temps de l'évolution de la surface libre et de la dynamique du corps.

Contents

3.1	Introduction and scope of the chapter	28
3.2	Discretization of the Boundary Integral Equations by BEM	29
3.3	Implicit fluid-body coupling for computation of $\partial\phi/\partial t$	29
3.4	Time integration of free surface and body boundary conditions	30
3.5	Summary and intermediate conclusions from the chapter	33

3.1 Introduction and scope of the chapter

The Boundary Element Method (BEM) relies on the spatial discretization of Boundary Integral Equations (BIEs), whose study started back more than a century ago. A precise history of the BEM is proposed by Bonnet [12], who mentions the first mathematical approach of the potential theory by Kellogg [52] and Gunther [44]. The numerical development of the BEM appeared however after the Finite Element Method (FEM), back in the 1960s. The principle of the BEM in the context of our two-dimensional Numerical Wave Tank is hereafter presented, but for a detailed review of the BEM with various applications, the reader is referred to the very educational books by Bonnet [12], Brebbia and Dominguez [15], or Ang [4].

As shown in the previous chapter, the 2D-NWT and 3D-NWT developed by Grilli and his collaborators are based on Eqs. (2.4) and (2.5) for the potential ϕ and its time derivative ϕ_t . Once completed by their respective boundary conditions, there is no easy analytical solutions to these boundary value problems, due to the complex domain geometry and variety of boundary conditions. A solution to the systems (2.26), (2.27) and (2.28) can be obtained using numerical methods based either on a discretization of the fluid domain (for example with the FEM) or on a boundary discretization (BEM). As explained by Grilli [35], BEM has three main advantages : (i) only the boundary is discretized, which reduces the dimensionality of the problem by one, (ii) there is a smaller number of unknowns compared to domain discretization methods which results in a smaller algebraic system to be solved, and (iii) any interior solution can be calculated as a function of boundary values. On the other hand, the BEM involves a high level of mathematics with singular integrations and the system matrix is generally full.

Eqs. (2.4) and (2.5) are transformed into BIEs, using Green's second identity (the mathematical justification of it can be found in these references [15, 12, 4]). The BIEs are thus evaluated at N discretization nodes \mathbf{x}_l on the boundary Γ :

$$\alpha(\mathbf{x}_l)u(\mathbf{x}_l) = \int_{\Gamma_n} \left[\overline{\frac{\partial u}{\partial n}} G - u \frac{\partial G}{\partial n} \right] d\Gamma + \int_{\Gamma_d} \left[\frac{\partial u}{\partial n} G - \bar{u} \frac{\partial G}{\partial n} \right] d\Gamma, l = 1..N \quad (3.1)$$

with u as the unknown value (either ϕ or ϕ_t) and $(\bar{u}, \overline{\partial u / \partial n})$ some values prescribed by the boundary conditions. $G \equiv G(\mathbf{x}, \mathbf{x}_l)$ is the Laplace problem Green's function given in two dimensions by :

$$\left\{ \begin{array}{l} G = -\frac{1}{2\pi} \ln r \end{array} \right. \quad (3.2)$$

$$\left\{ \begin{array}{l} \frac{\partial G}{\partial n} = -\frac{1}{2\pi} \frac{\mathbf{r} \cdot \mathbf{n}}{r^2} \end{array} \right. \quad (3.3)$$

$$\left\{ \begin{array}{l} r = |\mathbf{r}| = |\mathbf{x} - \mathbf{x}_l| \end{array} \right. \quad (3.4)$$

r is the distance from the integration point \mathbf{x} to the collocation point \mathbf{x}_l , belonging to the boundary Γ . Γ_n is all parts of the boundary where $\partial u / \partial n$ is imposed (Neumann condition), and Γ_d all parts where \bar{u} is imposed (Dirichlet condition).

3.2 Discretization of the Boundary Integral Equations by BEM

M higher-order elements are defined to interpolate in between discretization nodes, where both the geometry and the field variables are represented piecewise on the boundary using polynomial variations. In the present two-dimensional applications, quadratic isoparametric elements are used on lateral, bottom and body boundaries. Cubic elements are used on the free surface in order to ensure continuity of the boundary slope. In these latter elements, referred to as Mixed Cubic Interpolation (MCI) elements, geometry is modeled by cubic splines and field variables are interpolated between each pair of nodes, using the mid-section of a four-node “sliding” isoparametric element. Expressions of BEM integrals (regular, singular, quasi-singular) are given in Grilli et al. [39], Grilli and Svendsen [42], and Grilli and Subramanya [40, 41], for isoparametric and MCI elements.

Discretized BIEs are transformed into a linear matrix system $AY = B$ of dimension N , where the solution $Y = (y_l)_{l=1..N}$ contains the unknown values on the boundary (see [12, 35] for a detailed description of this assembling step). For the boundary value problem (2.26) for (ϕ, ϕ_n) , $y_l = \phi(x_l)$ if x_l is on a Neumann boundary and $y_l = \phi_n(x_l)$ if x_l is on a Dirichlet boundary. Vector B is based on the known values (ϕ, ϕ_n) on the boundaries and matrix A of size $N \times N$ depends only on the domain geometry. This system is solved using the well-known iterative General Minimal Residual Method, usually abbreviated GMRES.

3.3 Implicit fluid-body coupling for computation of $\partial \phi / \partial t$

In the case of a freely-moving body, both the position and velocity of nodes on the body boundary $\Gamma_c(t)$ at current time t , are assumed to be known from time-updating values from the previous time step. The Neumann boundary condition (2.11) on $\Gamma_c(t)$ for the (ϕ, ϕ_n) BIE is thus explicitly known, and this first problem is solved as for the prescribed motion case. However both ϕ_t and ϕ_{tn} , which are required for the Neumann condition of the second BIE for (ϕ_t, ϕ_{tn}) , remain unknown along $\Gamma_c(t)$. As detailed in the previous chapter, a second BIE (2.23) is added to the original BIE (3.1) for (ϕ_t, ϕ_{tn}) so that the number of equations equals the number of unknowns. This new system of BIEs yields an algebraic system of $(N + N_c)$ linear discretized equations with $(N + N_c)$ unknowns, where N_c is the number of nodes on the body boundary $\Gamma_c(t)$. This system is also solved using the GMRES algorithm. In most cases, for bodies with relatively simple geometry, N_c is no more than 10% of N so that the extra computational cost incurred by solving this larger linear system is quite marginal. As for the case of a prescribed motion, both the free surface position and potential can then be time-updated. This is detailed in the two following sections.

Finally, knowing ϕ_t along $\Gamma_c(t)$ makes it possible computing the pressure p using Eq. (2.19), which through Eqs. (2.15) and (2.16) yields the body center of mass accelerations \ddot{x}_G and $\ddot{\theta}_G$ (taking into account all other externally applied forces and moments). These can be integrated in time to yield the position and velocity of the body boundary nodes at the next time step.

3.4 Time integration of free surface and body boundary conditions

Both Laplace problems, discussed above, are solved at any given time t using a BEM in domain geometry $\Omega(t)$. Given such a solution, both domain geometry and boundary conditions are then updated to time $t + \Delta t$, where Δt denotes a small time step. Specifically, time updating involves :

- for the fluid : the free surface elevation and potential, and the lateral boundaries geometry and kinematics (e.g., generating and absorbing wavemakers),
- for the rigid submerged body : the position (defined by that of its center of mass and rotation around the latter) and velocity of BEM nodes distributed along its boundary.

The new positions of various boundaries thus define a new geometry $\Omega(t + \Delta t)$ for the fluid domain. The two next subsections briefly describe the time updating of the free surface, and that of the freely moving body. Note that the same time step Δt is used for both fluid and body updating.

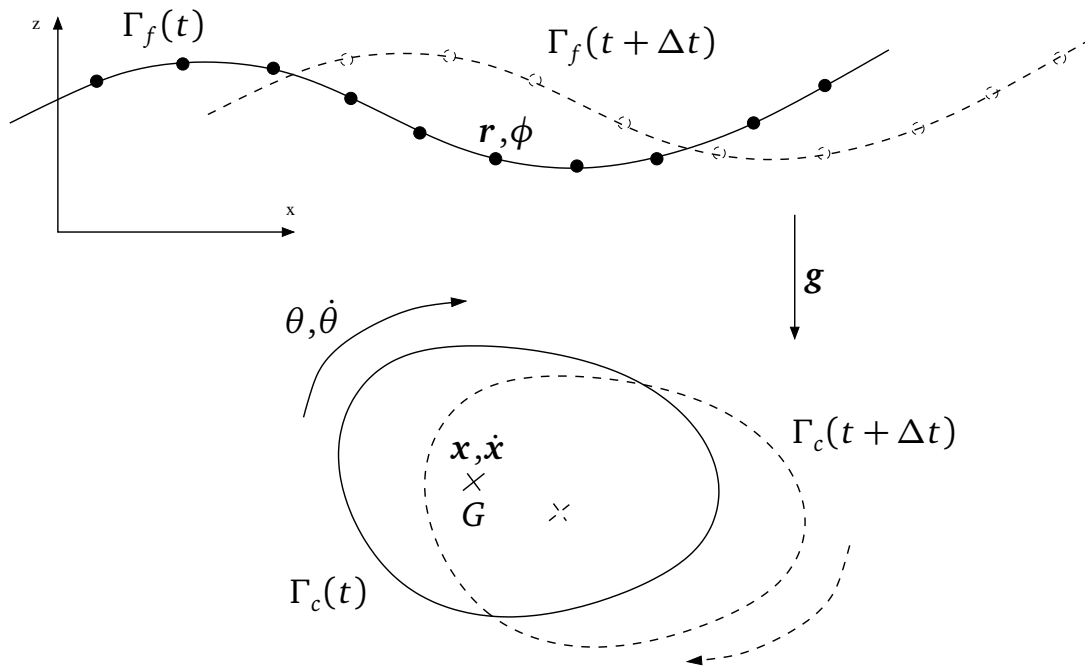

FIGURE 3.1 – Time-integration of free-surface boundary $\Gamma_f(t)$ (position of nodes \mathbf{r} and free-surface velocity potential ϕ) and body boundary $\Gamma_c(t)$ (center of mass position \mathbf{x} and velocity $\dot{\mathbf{x}}$, as well as angular position θ and velocity $\dot{\theta}$).

3.4.1 Time integration of free surface boundary conditions

Free-surface geometry and potential are explicitly time-updated based on two second-order Taylor series expansions, expressed in terms of a time step Δt and of the successive Lagrangian time derivative D/Dt , of ϕ and \mathbf{r} (see e.g. [39]),

$$\begin{aligned}\mathbf{r}(t + \Delta t) &= \mathbf{r}(t) + \Delta t \frac{D\mathbf{r}}{Dt}(t) + \frac{\Delta t^2}{2} \frac{D^2\mathbf{r}}{Dt^2}(t) \\ \phi(t + \Delta t) &= \phi(t) + \Delta t \frac{D\phi}{Dt}(t) + \frac{\Delta t^2}{2} \frac{D^2\phi}{Dt^2}(t)\end{aligned}\quad (3.5)$$

\mathbf{r} denotes here the vector position of the free-surface nodes, and ϕ the velocity potential at these nodes (see Fig. 3.1). First-order coefficients in these series are identical to the free surface conditions (2.6) and (2.7), in which ϕ and ϕ_n are obtained from the solution of the BIE for (ϕ, ϕ_n) at time t . Second-order coefficients are expressed as D/Dt of Eqs. (2.6) and (2.7), and calculated using, additionally, the solution of the second BIE for (ϕ_t, ϕ_{tn}) , for which boundary conditions are obtained from the solution of the first problem, and also from the treatment of the submerged body detailed before. Detailed expressions for the Taylor series are given in Grilli et al. [39]. In our simulations, the time step Δt is adjusted at each iteration, depending on an optimal Courant number C_0 (chosen about 0.45 based on [42]) and the minimal distance Δr_{min} between two nodes on the free surface, as,

$$\Delta t = C_0 \frac{\Delta r_{min}}{\sqrt{gh}} \quad (3.6)$$

where h is the local water depth. The accuracy and stability of this explicit scheme was found so high that no filtering or smoothing was needed on the free surface, even after thousands of time steps. More details about the stability and convergence of the time integration scheme of the hydrodynamic solver, as well as a detailed review of 2D applications can be found in [34].

3.4.2 Time integration of body motion equations

At the end of the current time step t , once the two Laplace problems are solved, the free surface boundary conditions are first explicitly integrated to the next time step $t + \Delta t$, as seen in the previous section. Rigid body motion is now time-integrated based on an implicit Newmark scheme [64], which was retained among a series of methods because of its accuracy and stability. This scheme reads, for the case of Eq. (2.15),

$$\begin{aligned}\dot{\mathbf{x}}(t + \Delta t) &= \dot{\mathbf{x}}(t) + \Delta t [(1 - \gamma)\ddot{\mathbf{x}}(t) + \gamma\ddot{\mathbf{x}}(t + \Delta t)] \\ \mathbf{x}(t + \Delta t) &= \mathbf{x}(t) + \Delta t \dot{\mathbf{x}}(t) + \Delta t^2 [(\frac{1}{2} - \beta)\ddot{\mathbf{x}}(t) + \beta\ddot{\mathbf{x}}(t + \Delta t)]\end{aligned}\quad (3.7)$$

and for the case of Eq. (2.16),

$$\begin{aligned}\dot{\theta}(t + \Delta t) &= \dot{\theta}(t) + \Delta t [(1 - \gamma)\ddot{\theta}(t) + \gamma\ddot{\theta}(t + \Delta t)] \\ \theta(t + \Delta t) &= \theta(t) + \Delta t \dot{\theta}(t) + \Delta t^2 [(\frac{1}{2} - \beta)\ddot{\theta}(t) + \beta\ddot{\theta}(t + \Delta t)]\end{aligned}\quad (3.8)$$

where parameters were selected as $\gamma = 1/2$ and $\beta = 1/4$, corresponding to the so-called average acceleration method, which is second-order and unconditionally stable for linear systems. The time step Δt used here for updating the rigid body motion is kept identical as the one obtained with Eq. (3.6) for the free surface updating.

The body kinematics, namely the position $\mathbf{x}(t)$ and velocity $\dot{\mathbf{x}}(t)$ of its center of mass in Eq. (3.7), and the rotation angle $\theta(t)$ and angular velocity $\dot{\theta}(t)$ about its center of mass in Eq. (3.8), are known (see Fig. 3.1). At the end of the current iteration, once the two Laplace problems are solved, the hydrodynamic force $\mathbf{F}_p(t)$ and momentum $\mathbf{M}_p(t)$ are computed by integrating the pressure on the body boundary,

$$\mathbf{F}_p(t) = \int_{\Gamma_c(t)} p \mathbf{n} d\Gamma \quad (3.9)$$

$$\mathbf{M}_p(t) = \int_{\Gamma_c(t)} p(\mathbf{r} \times \mathbf{n}) d\Gamma \quad (3.10)$$

Through body motion equations (2.15) and (2.16), we now have access to the accelerations $\ddot{\mathbf{x}}(t)$ and $\ddot{\theta}(t)$ of the body center of mass at the current time step. However, updating the body kinematics with the Newmark scheme (3.7) and (3.8) also requires the accelerations $\ddot{\mathbf{x}}(t + \Delta t)$ and $\ddot{\theta}(t + \Delta t)$, which are obtained with a predictor-corrector loop, presented hereafter.

The predictor-corrector algorithm

1. **Prediction step** : we define \mathbf{F}_p^1 and \mathbf{M}_p^1 the extrapolated values of the hydrodynamic pressure force $\mathbf{F}_p(t + \Delta t)$ and momentum $\mathbf{M}_p(t + \Delta t)$, respectively, at the next time step, based on a 4th-order polynomial extrapolation with quantities calculated at the five previous time steps. Body motion equations (2.15) and (2.16) are then used to predict the accelerations $\ddot{\mathbf{x}}(t + \Delta t)$ and $\ddot{\theta}(t + \Delta t)$ at the next time step.
2. **Correction step** : the predicted kinematics of the body center of mass ($\mathbf{x}(t + \Delta t)$, $\dot{\mathbf{x}}(t + \Delta t)$, $\theta(t + \Delta t)$, $\dot{\theta}(t + \Delta t)$) obtained with Newmark equations (3.7) and (3.8), is used to update the body position and body boundary conditions in order to solve for the two Laplace problems for the potential and its time derivative. The resulting hydrodynamic force and momentum, namely $(\mathbf{F}_p^2, \mathbf{M}_p^2)$, are compared to the last prediction $(\mathbf{F}_p^1, \mathbf{M}_p^1)$ by calculating the relative error between these two successive sub-iterations :

$$\left\{ \begin{array}{l} \epsilon_{\mathcal{F}} = \left| \frac{\mathbf{F}_p^2 - \mathbf{F}_p^1}{\mathbf{F}_p^2} \right| \\ \epsilon_{\mathcal{M}} = \left| \frac{\mathbf{M}_p^2 - \mathbf{M}_p^1}{\mathbf{M}_p^2} \right| \end{array} \right. \quad (3.11)$$

If these errors are not smaller than a threshold value (typically 10^{-6}), another sub-iteration is started at prediction step, using the new values $(\mathbf{F}_p^2, \mathbf{M}_p^2)$ to predict the accelerations $\ddot{\mathbf{x}}(t + \Delta t)$ and $\ddot{\theta}(t + \Delta t)$ using body motion equations.

This loop is started over until convergence on both pressure force and momentum is reached. We made use of the so-called frozen coefficient method in order to accelerate the convergence : as did by Ferrant [30] and Shirakura [68], the influence matrices are computed only

once at first sub-iteration and used again at every other sub-iteration. This procedure makes sense since only the body position and velocity changes between two successive steps, and the change of influence matrix is small. Simple tests were made and a considerable acceleration is obtained without much loss of accuracy.

A 10^{-6} convergence is generally obtained after two sub-iterations. An example of the required number N_i of sub-iterations for the convergence of the hydrodynamic pressure force will be presented in chapter 5, section 5.2.2, for a numerical application (see Figs. 5.4 and 5.5).

3.5 Summary and intermediate conclusions from the chapter

This chapter described the numerical implementation in 2DV of the coupled hydro-mechanical modelling. We briefly reviewed the main principles of the BEM for the discretization of BIEs, with a focus on the numerical solving of the Laplace problem for ϕ_t . Second part of the chapter was devoted to the time marching algorithm for the evolution of the free surface and the body dynamics.

Chapters 4, 5 and 6 will present various numerical applications of our 2DV model in situations involving wave interactions with a submerged horizontal cylinder of circular cross-section, while chapter 7 will present the preliminary 3D results obtained on wave interactions with a submerged sphere.

4

Validation of the numerical model for horizontal circular cylinders in specified motions

Plusieurs applications du modèle sur des cas de mouvements forcés de cylindre circulaire sont traités dans ce chapitre. Dans un premier temps, on vérifie la bonne conservation du volume de fluide dans le domaine de calcul sur un cas de cylindre pilonnant dans un canal initialement au repos. Dans un second temps, les forces hydrodynamiques exercées sur un cylindre circulaire fixe, en pilonnement et en rotation circulaire sont comparées à des résultats issus d'expériences ou de théories analytiques.

Contents

4.1	Introduction and scope of the chapter	36
4.2	Conservation of fluid volume	36
4.3	Nonlinear forces on a fixed cylinder (Chaplin, 1984)	40
4.4	Nonlinear forces on a cylinder in a specified heaving motion (Wu, 1993)	43
4.5	Nonlinear forces on a cylinder in a specified circular motion (Wu, 1993)	46
4.6	Summary and intermediate conclusions from the chapter	49

4.1 Introduction and scope of the chapter

Now that we have formulated the mathematical problem and presented the numerical implementation of our 2DV-NWT, we focus in this chapter on the validation of our tool on various situations involving the prescribed motion (either fixed, purely heaving, or on a clockwise circular path) of a two-dimensional submerged circular cylinder. As mentioned earlier, there is no wave-body coupling in this type of situation, and the moving body boundary condition is similar to that of a solid wavemaker boundary. Through various applications, we intend in this chapter to validate (i) the wave diffraction (fixed cylinder under incident regular waves) and (ii) wave radiation (moving cylinder under a free surface initially at rest). For both phenomena, we will inquire the nonlinear effects on the forces on the cylinder by gradually increasing the incident wave amplitude (case (i)) or the body motion amplitude (case (ii)). First, the sensitivity of our numerical results to free surface spatial discretization will be assessed by checking the ability to conserve fluid volume in the computational domain, in situation with a heaving cylinder immersed in a tank with lateral reflective walls, at two depths of submergence. In a second section, the computed nonlinear forces on a fixed cylinder will be compared to Chaplin's experiments with a good agreement, for various Kc numbers. Finally, the computed nonlinear forces on a cylinder describing large amplitude heaving motions and large amplitude circular motions will be compared to Wu's analytical predictions, also with a good agreement.

4.2 Conservation of fluid volume

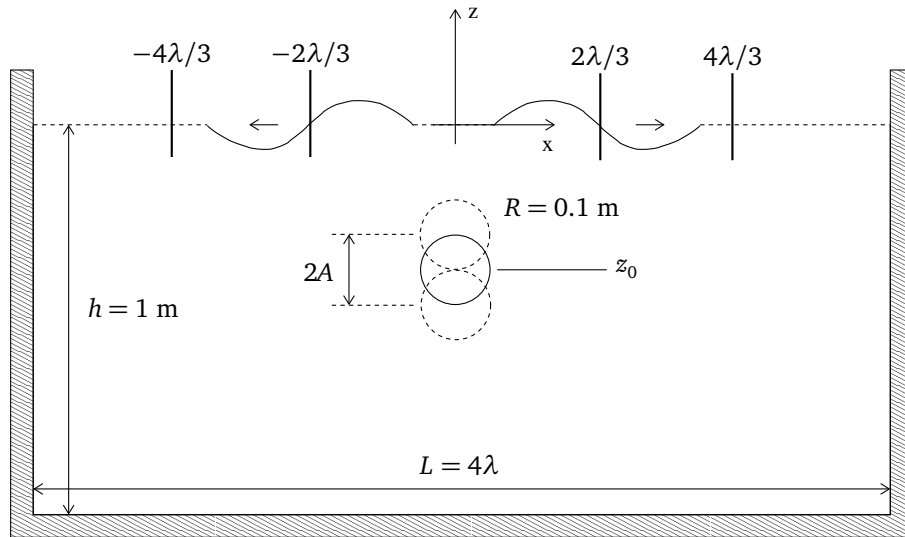

FIGURE 4.1 – Sketch of problem geometry for a cylinder of radius $R = 0.1 \text{ m}$ in forced heaving motion of amplitude $A = R$ and period T , in water of depth $h = 1 \text{ m}$.

In this section, we assess the convergence and accuracy of the 2DV-NWT results, for a submerged cylinder in a forced heaving motion in a water volume initially at rest. Conservation of the fluid volume is checked at each time step.

A cylinder of radius $R = 0.1 \text{ m}$ is initially submerged at a position $z_c = z_0$ under the free surface at rest, in the middle of a 2DV-NWT of depth $h = 10R = 1 \text{ m}$ with lateral reflective

vertical walls (Fig 4.1). The cylinder is gradually accelerated into periodic heave (i.e., vertical) motion of amplitude $A = R$ and period T , centered on its initial position z_c . The motion of the cylinder generates symmetric waves of wavelength λ , moving in both leftward and rightward directions. The total length of the wave tank is taken to $L = 4\lambda$ with the cylinder located at mid length $x_c = L/2$.

Four cases are successively computed, for two submergence depths $z_0 = -5R = -0.5$ m and $z_0 = -4R = -0.4$ m, and two periods of oscillation $T = 0.5$ and 0.8 s, corresponding to linear wavelengths $\lambda = 0.39$ and 1.00 m, respectively, based on the linear dispersion relationship,

$$\lambda = \frac{gT^2}{2\pi} \tanh\left(\frac{2\pi h}{\lambda}\right) \quad (4.1)$$

All simulations are conducted for 40 periods of oscillation. For a given wavelength, as the mean elevation of the cylinder comes closer to the free surface (z_0 gets closer to zero), the height of generated waves increased and nonlinear effects become more significant. Note, z_0 is kept sufficiently low to prevent waves from overturning over the cylinder and the cylinder from piercing the free surface. Regridding to equal node spacing on the free surface only is applied at every time step.

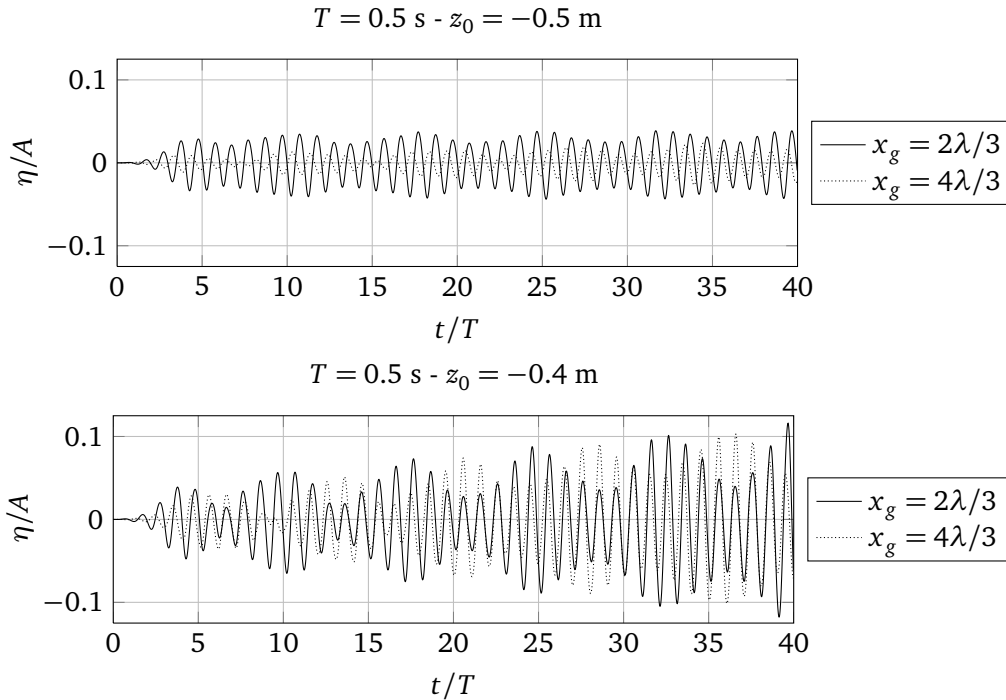

FIGURE 4.2 – Case of Fig. 4.1. Non-dimensional free surface elevation (with respect to the amplitude of oscillation A of the cylinder) as a function of non-dimensional time, computed at numerical gages located at $x_g = 2\lambda/3$ (—) and $4\lambda/3$ (.....) from the cylinder, for two submergence depths z_0 of the cylinder : (a) -0.5 m; (b) -0.4 m. The forced heave amplitude is $A = 0.1$ m and period $T = 0.5$ s.

Fig. 4.2 first shows the computed free surface elevation at two numerical gages located at horizontal distances $x_g = 2\lambda/3$ and $4\lambda/3$ from the axis of the cylinder (Fig. 4.1), for two

submergence depths of the cylinder, and the period $T = 0.5$ s. Symmetric waves generated by the cylinder propagate towards each extremity of the tank. After reflection on sidewalls, reflected and incident waves interact, resulting in a growing wave amplitude in some local areas of the tank, as clearly seen in Fig. 4.2 showing the wave records at both gages. As expected, nonlinear effects become more important when the cylinder is closer to the free surface ($z_0 = -0.4$ m). The local wave steepness is defined as H/λ , H being the difference between two successive maximum and minimum of the position of the free surface at a defined location. For instance, steepness at the gages grows from 1.7% after 6 periods of oscillation to 5.1% after 35 periods of oscillation, for $z_0 = -0.4$ m.

The effect of the free surface spatial discretization step Δx on volume conservation is assessed next. Considering an initial fluid volume V_0 , the instantaneous relative absolute error on volume conservation is defined as,

$$\epsilon_v(t) = \frac{|V(t) - V_0|}{V_0} \quad (4.2)$$

Fig. 4.4 shows numerical results for each of the four cases, when successively using a number of BEM nodes per wavelength on the free surface $\Gamma_f(t) : N_f = \lambda/\Delta x = 15, 25, 50, 75$, from coarse to fine. We see that the volume error slightly grows with time in each computation, but its maximum value stays at an acceptable level, of less than 0.01%, in all cases for $T = 0.5$ s and for the two finest discretization steps for $T = 0.8$ s. Fig. 4.3 summarizes these results by plotting the mean volume error of Fig. 4.4, after 40 periods of heave oscillations, as a function of the non-dimensional spatial discretization step on the free surface. Each curve in the figure has a slope of about 2.7, which shows that convergence of results with spatial discretization is nearly 3rd-order.

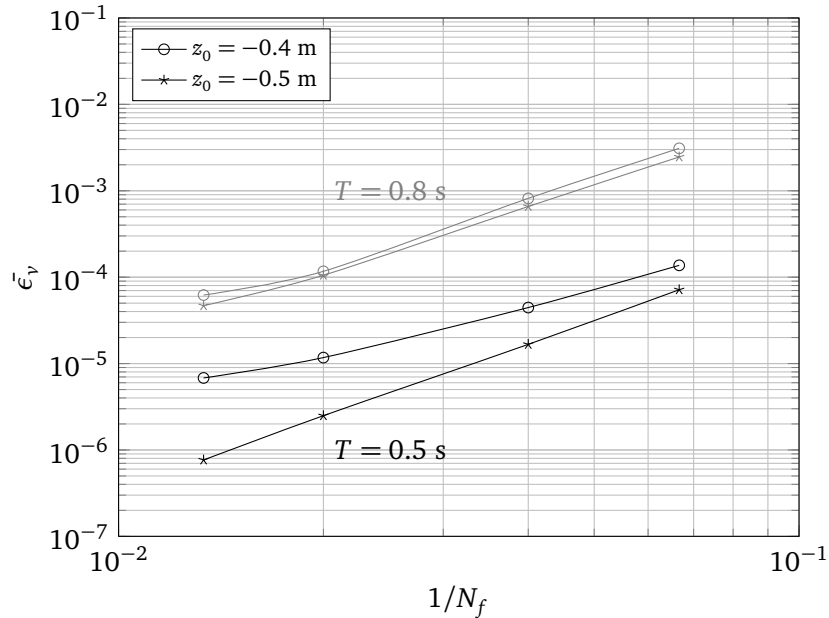

FIGURE 4.3 – Case of Fig. 4.1. Mean volume error after 40 periods of heave oscillation, for $T = 0.5$ s and $T = 0.8$ s and two cylinder submergence depths, as a function of the nondimensional discretization step $1/N_f = \Delta x/\lambda$.

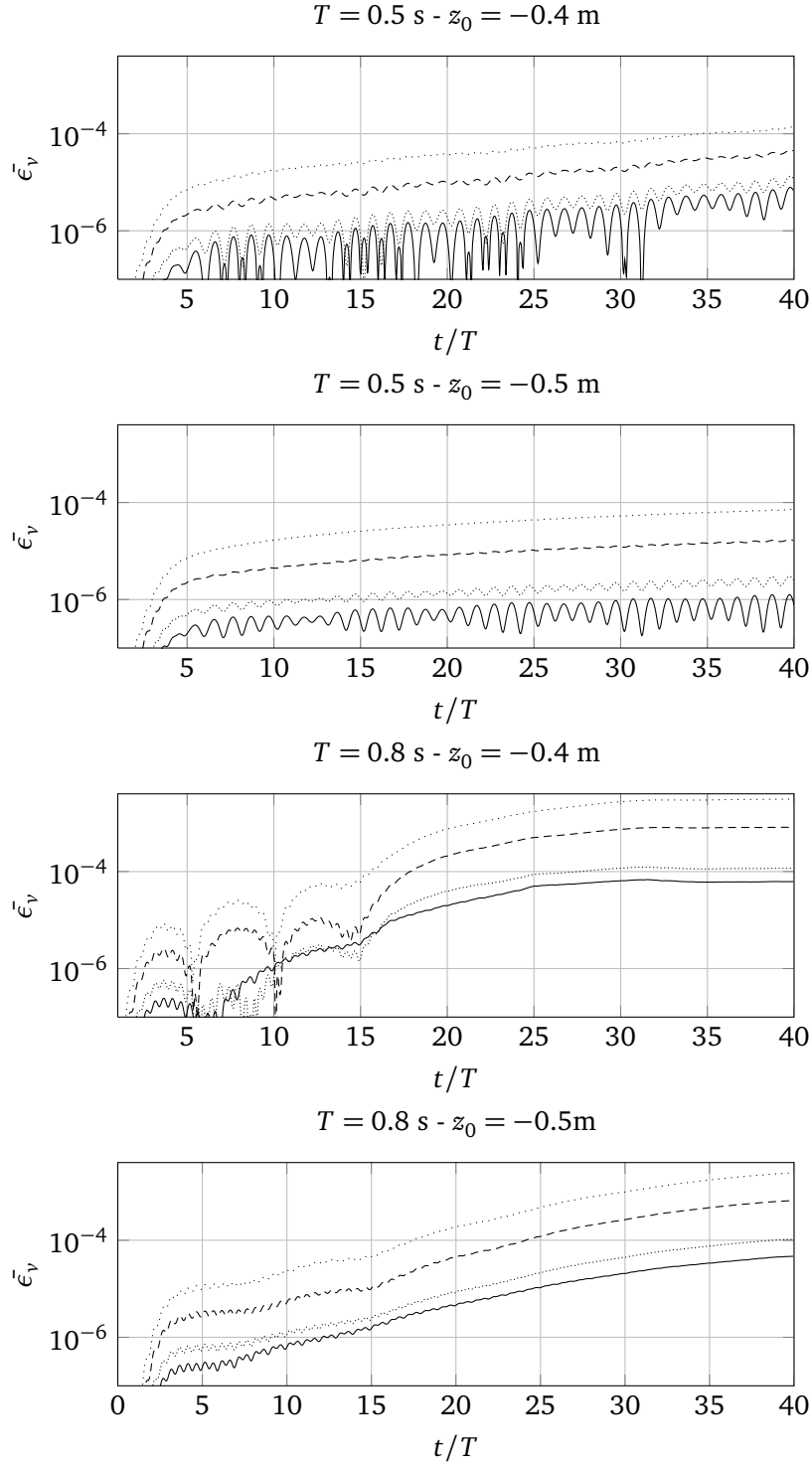

FIGURE 4.4 – Case of Fig. 4.1. Error on volume conservation in the computational domain Ω , for two cylinder submergence depths z_0 and two periods of oscillation T . For each case, results for four spatial free surface discretization steps $\Delta x = \lambda/N_f$ are plotted : $N_f = 15$ (.....), $N_f = 25$ (----), $N_f = 50$ (-.....), $N_f = 75$ (—).

4.3 Nonlinear forces on a fixed cylinder (Chaplin, 1984)

Significant research was devoted to analyzing diffraction around a submerged fixed cylinder. Thus Dean [24], using a linearized potential theory, showed that there is no reflection of incident waves by the cylinder, and that transmitted waves only undergo a phase shift when passing the obstacle. Ursell [77] and later Ogilvie [65] extended the formulation up to the second order in wave steepness. Chaplin [19] experimentally measured in 1984 the nonlinear force on a horizontal fixed cylinder beneath waves in a wave flume. In particular he analyzed the influence of the Keulegan-Carpenter number, previously introduced in subsection 2.3.2, onto the harmonics of the applied force. Based on the linear wave theory in infinite water depth, Kc can be written :

$$Kc = \frac{\pi H}{2R} e^{kz_c} = \frac{\pi A}{R} e^{kz_c} \quad (4.3)$$

where $H = 2A$ is the wave height, R the cylinder radius, k the wave number, and z_c the cylinder submergence.

Chaplin's results were in good agreement with Ogilvie's theory when the wave steepness was low, but important nonlinear effects were experimentally observed for higher steepness. Grue and Granlund [43] also conducted some experiments, focusing on the diffracted waves.

Numerical tests are conducted with the present NWT and the computed hydrodynamic forces compared to Chaplin's results for case E. Waves are generated using the stream-function wave method in a flume of water depth $h = 0.85$ m and length $L = 29.6$ m; an absorbing beach is implemented over the last 7 m. The wave period is $T = 1$ s and the wave height is progressively increased from 0.0018 m to 0.0720 m. The cylinder of radius $R = 0.051$ m is placed 8 m away from the wavemaker, at $z_c = -0.102$ m under the undisturbed free surface. In the BEM, 350 nodes are used on the free surface, and 25 on the cylinder boundary. Following Chaplin, the non-dimensional vertical F_z and horizontal F_x forces are written as Fourier series and the amplitudes of the harmonics are computed with a FFT over the last 3 periods of the simulations :

$$\frac{F_x}{\rho R^3 \omega^2} = F_x^{(0)} + \sum_{n \geq 1} F_x^{(n)} \cos(n\omega t + \psi^{(n)}) \quad (4.4)$$

$$\frac{F_z}{\rho R^3 \omega^2} = F_z^{(0)} + \sum_{n \geq 1} F_z^{(n)} \sin(n\omega t + \psi^{(n)}) \quad (4.5)$$

Fig. 4.5 shows a good agreement of the mean vertical force with both Chaplin's experimental results [19] and Ogilvie's second-order theory [65]. However, the first harmonics (Fig. 4.6) only agrees with Chaplin's measurements at the lower values of Kc . At larger values, the decrease of the experimental first-order coefficient is not reproduced by the model, likely due to viscous effects and the recirculation created around the body (Chaplin, 1984). This is confirmed by Tavassoli and Kim's [75] simulations, performed in a viscous NWT, who did obtain the experimental decrease. Some of their results are presented on Fig. 4.6. The second and third harmonics are also computed (Fig. 4.7) with a good general agreement with measurements. A slight discrepancy is observed at larger values of Kc , which can also be attributed to viscous effects, as also shown by the model results of Tavassoli and Kim [75]. Note, in these simulations, no sawtooth instabilities of the free surface nor breaking of waves passing over the cylinder are observed.

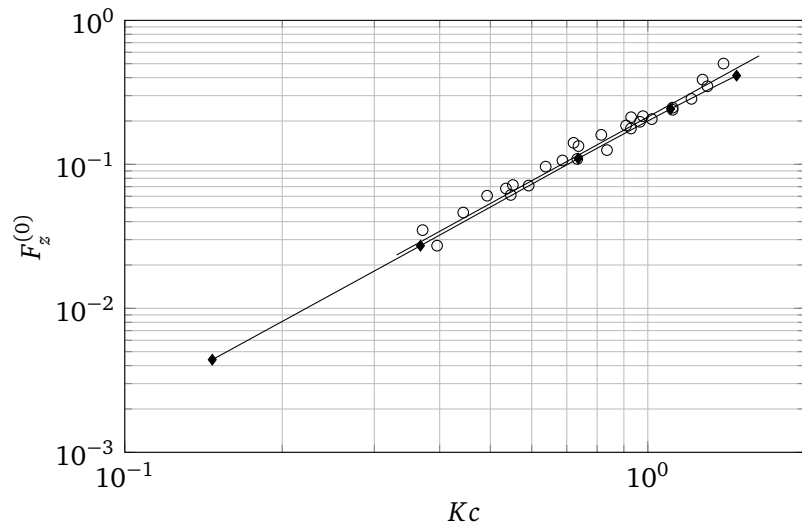

FIGURE 4.5 – Adimensioned Mean Vertical Force - NWT results (\blacklozenge) compared to Chaplin's (1984) experiments (\circ) and to 2nd order theory of Ogilvie (1963) (—).

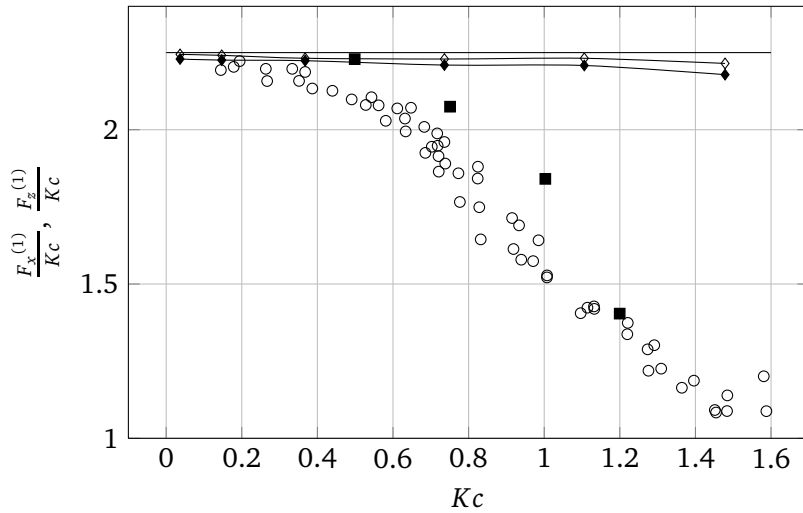

FIGURE 4.6 – 1st harmonic of the horizontal (\blacklozenge) and vertical force (\blacklozenge) compared to Chaplin's (1984) experiments (\circ), linear theory of Ogilvie (1963) (—) and viscous simulations of Tavassoli and Kim (2001) (\blacksquare).

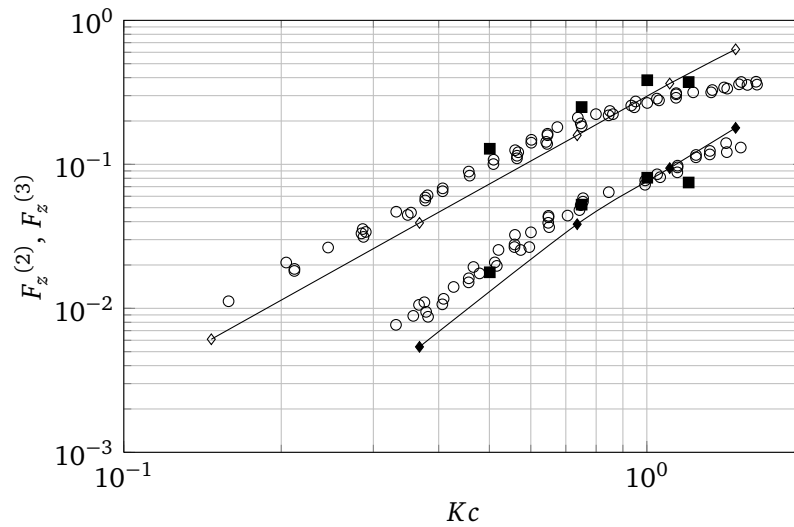

FIGURE 4.7 – 2nd (\diamond) and 3rd (\circ) harmonics of the adimensioned vertical force compared to Chaplin’s (1984) experiments (\circ) and viscous simulations of Tavassoli and Kim (2001) (\blacksquare).

The results computed by the present model are in good agreement with Chaplin’s results up to the point where viscous effects play a significant role. Other numerical studies based on potential theory were compared to Chaplin’s experiments without any better agreement : e.g. Liu et al. [57] and Kent and Choi [53] using a HOS method, Cointe [22] and Koo and Kim [54] using a BEM. This confirms the ability of the present model to reproduce nonlinear wave interactions with a structure, submerged quite close to the free surface.

4.4 Nonlinear forces on a cylinder in a specified heaving motion (Wu, 1993)

Wu [80] analytically solved the wave radiation problem for a submerged circular cylinder of radius R , in forced heaving motion in still water of infinite depth. The cylinder boundary condition was satisfied at its instantaneous position, allowing for large amplitude motion, while the free surface conditions were linearized. The wavenumber of generated waves was thus assumed to satisfy the linear dispersion relationship in infinite depth $k = \omega^2/g$. Wu expressed the radiated wave potential as a multipole expansion and computed the vertical hydrodynamic force exerted on the cylinder, assuming a purely vertical motion, for two non-dimensional wavenumbers, $kR = 0.1$ and 1.0 , and 8 amplitudes of motion A/R . The non-dimensional vertical force was expanded in a Fourier series as,

$$\frac{F_z}{\rho A \pi R^2 \omega^2} = F_z^{(0)} + \sum_{n \geq 1} F_z^{(n)} \sin(n\omega t + \psi^{(n)}) \quad (4.6)$$

We run numerical simulations for all of Wu's cases, in a NWT of water depth $h = 3$ m and length $L = 20$ m. A cylinder of radius $R = 0.1$ m was placed at mid-length, 10 m away from the leftward boundary, and submerged at $z_c = -3R$ under the undisturbed free surface (mean position). The cylinder is subjected to forced heaving oscillations of angular frequency ω (or period $T = 2\pi/\omega$) and amplitude A . A two period ramp-up is specified to gradually reach steady-state and prevent instabilities that could occur for an impulsive start. Simulations last over a few periods of oscillation and are stopped before reflection appears.

The hypothesis of infinite depth made by Wu was approximately verified in simulations, for the first frequency of oscillations $kR = 0.1$, $k = 1 \text{ m}^{-1}$, $T = 2.01$ s ($kh = 3 \simeq \pi$) and for the second one $kR = 1.0$, $k = 10 \text{ m}^{-1}$, $T = 0.63$ s ($kh = 30$). For both frequencies, 200 nodes are used on the free surface and 80 on the cylinder, in the BEM. Simulations last for about 10 periods, starting from a free-surface at rest. In the model, as before, the cylinder motion generates symmetric waves that propagated in both leftward and rightward directions (Fig. 4.8).

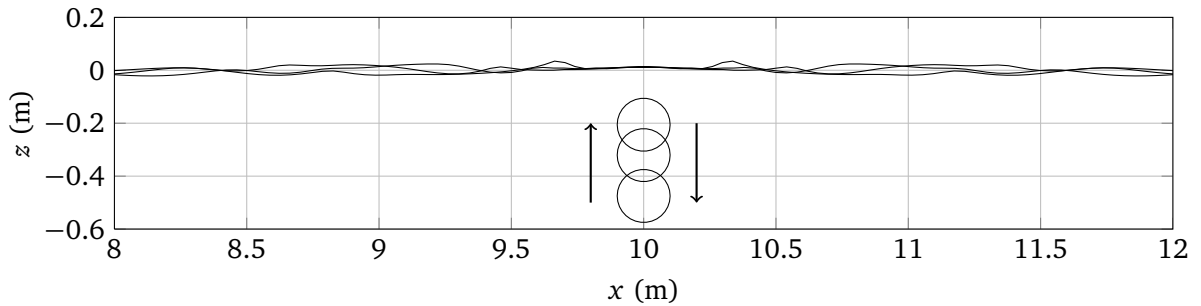

FIGURE 4.8 – Forced heaving motion of a cylinder of radius $R = 0.1$ m in depth $h = 3$ m. Successive snapshots of waves generated at $t/T = 2.75, 2.99, 3.10$ for an amplitude $A/R = 1.75$, and $kR = 0.1$ (period $T = 2.01$ s).

To compare our results with Wu's results [80], a Fourier transform is applied to the time series of computed vertical pressure force, as defined in Eq. (4.6), i.e., in nondimensional form, for the last period of simulation. This comparison is shown in Figs. 4.9 to 4.11, for the

zero-th (mean), first, and second harmonics of this force. The agreement with Wu's results is excellent for small amplitudes of motion, but less so for the larger amplitudes. For $A/R > 1$, the cylinder is moving quite close to the free surface and nonlinear effects play a more significant role; hence Wu's model is expected to be increasingly in error, while our BEM model, which solves FNPF equations, stays accurate throughout. This may explain the discrepancies observed for the larger amplitudes. For the first frequency ($kR = 0.1$), the mean vertical force and the first and second harmonics increase with the amplitude of motion. By contrast, for the larger frequency ($kR = 1$), only the second harmonic is growing with the amplitude while the mean vertical force is negative, and increasingly so, and the first harmonic is decreasing, with increasing amplitude.

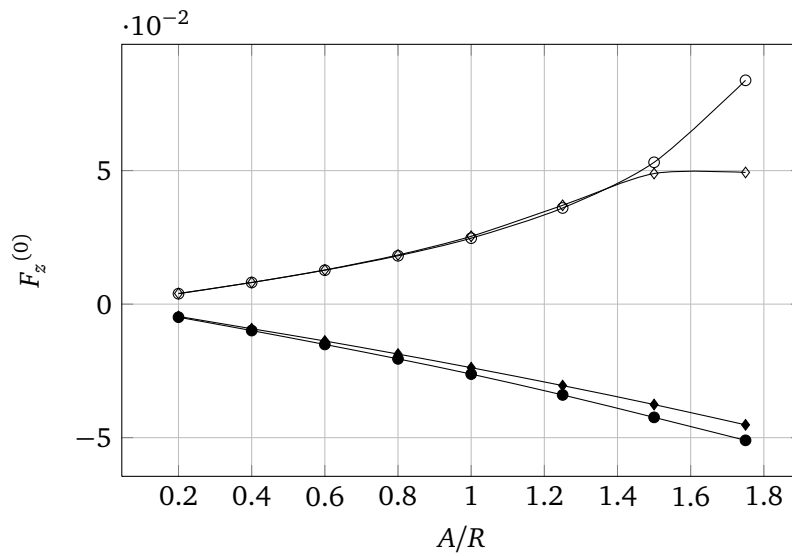

FIGURE 4.9 – Nondimensional Mean vertical force results computed by BEM for $kR = 0.1$ (\diamond) and $kR = 1$ (\blacklozenge), compared to Wu's linear theory (\circ , \bullet) for various amplitudes of body motion.

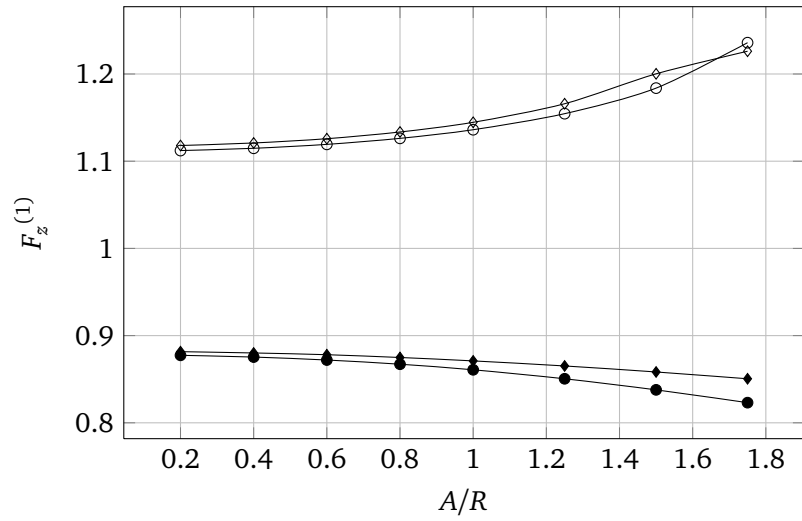

FIGURE 4.10 – 1st harmonic of the vertical force results computed by BEM for $kR = 0.1$ (\diamond) and $kR = 1$ (\blacklozenge), compared to Wu's linear theory (\circ , \bullet) for various amplitudes of body motion.

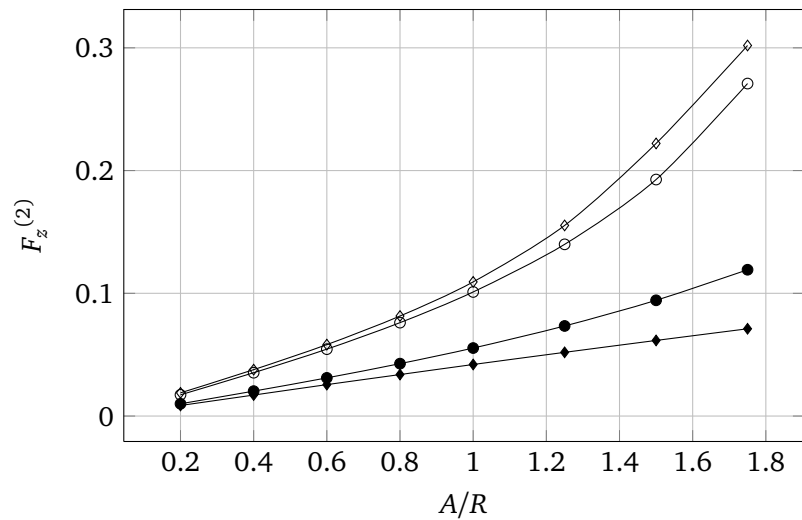

FIGURE 4.11 – 2nd harmonic of the vertical force results computed by BEM for $kR = 0.1$ (\diamond) and $kR = 1$ (\blacklozenge), compared to Wu's linear theory (\circ , \bullet) for various amplitudes of body motion.

4.5 Nonlinear forces on a cylinder in a specified circular motion (Wu, 1993)

Another interesting case treated by Wu [80] is that of a horizontal circular cylinder in a large-amplitude circular motion. Wu computed the harmonics of the vertical and horizontal hydrodynamic forces for different amplitudes of motion, and one frequency ($kR = 0.5$).

$$\frac{F_x}{\rho A \pi R^2 \omega^2} = F_x^{(0)} + \sum_{n \geq 1} F_x^{(n)} \cos(n\omega t + \psi^{(n)}) \quad (4.7)$$

$$\frac{F_z}{\rho A \pi R^2 \omega^2} = F_z^{(0)} + \sum_{n \geq 1} F_z^{(n)} \sin(n\omega t + \psi^{(n)}) \quad (4.8)$$

Starting from a free surface at rest, waves are generated only in the rightward direction (Fig. 4.12), for a clockwise motion.

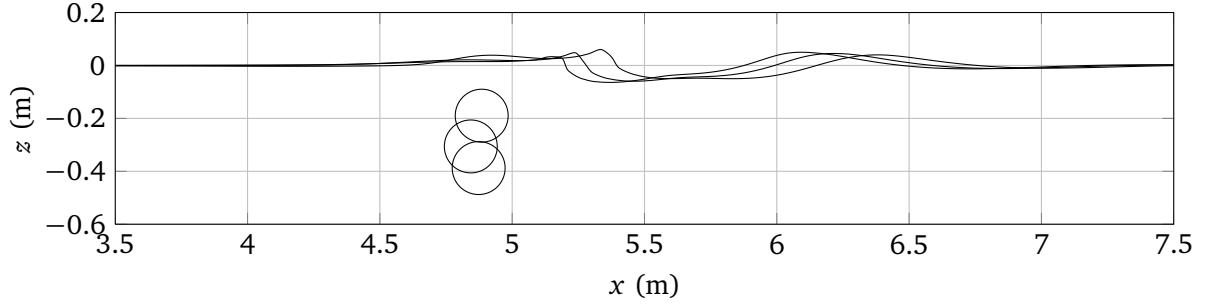

FIGURE 4.12 – Successive snapshots ($t/T = 4.40$, $t/T = 4.49$, $t/T = 4.62$) of waves generated by the clockwise circular motion of a cylinder ($A/R = 1.75$, $kR = 0.5$).

Numerical simulations are performed in a flume of water depth $h = 3$ m and length $L = 20$ m, with an absorbing beach over the last 7 m. A cylinder of radius $R = 0.1$ m is placed at 5 m away from the left boundary and $z_c = -3R$ under the undisturbed free surface and is moved on a circular path with a rotational speed ω and radius A . The hypothesis of infinite depth made by Wu is verified in our simulations, with $kh = 5$. Like for the purely vertical motion, in the BEM, 200 nodes are used on the free surface and 80 on the cylinder ; here, simulations lasted for about 15 periods.

The mean non-dimensional forces are plotted in Fig. 4.14, while the first and second harmonics of these forces are shown in Fig. 4.15 and Fig. 4.16. These figures show a good agreement with Wu's results for amplitudes of motion below $A/R = 1$. Nonlinear effects play a significant role beyond this limit, as shown on the vertical force (Fig. 4.13) :

Kent and Choi [53] also compared results of their NWT based on the HOS method to Wu's analytical results. Unfortunately they did not go beyond a $A/R = 0.6$ amplitude of motion, for which nonlinear effects do not clearly manifest themselves.

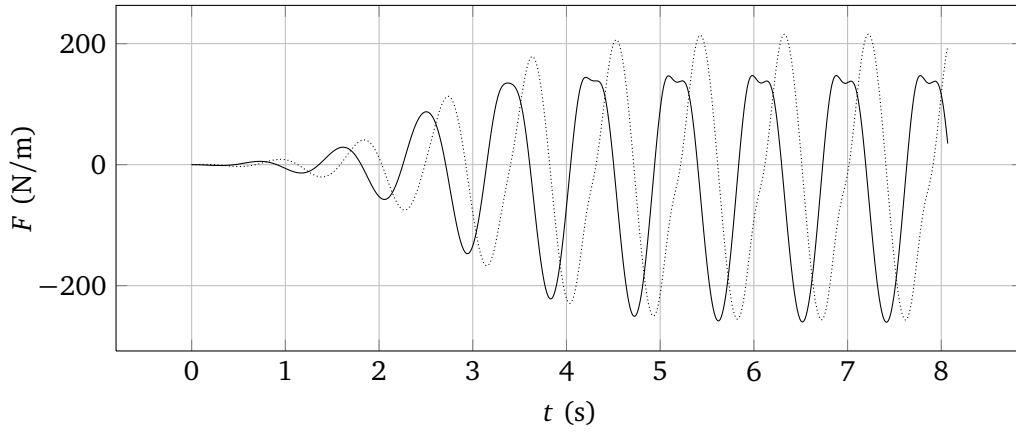

FIGURE 4.13 – Vertical (—) and horizontal (.....) hydrodynamic forces exerted on the cylinder - $kR = 0.5$ and $A/R = 1.75$.

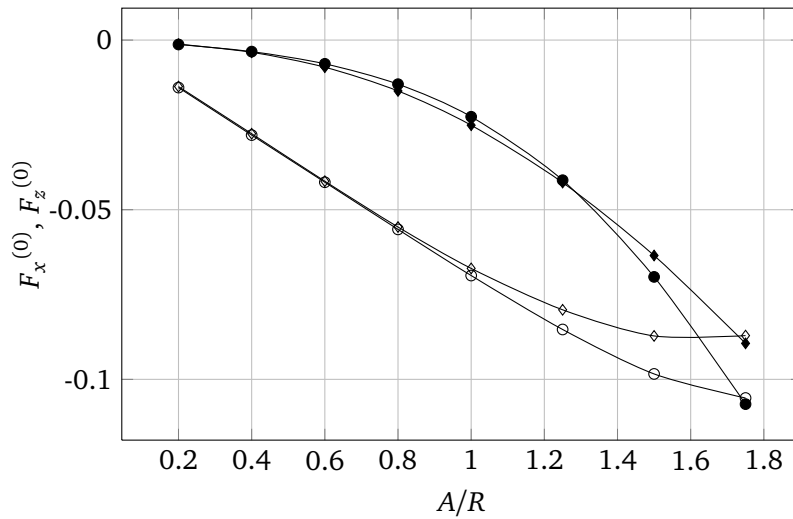

FIGURE 4.14 – Mean non-dimensional vertical (\blacklozenge) and horizontal (\blacklozenge) forces with $kR = 0.5$, compared to Wu's (1993) analytical theory (\bullet , \circ).

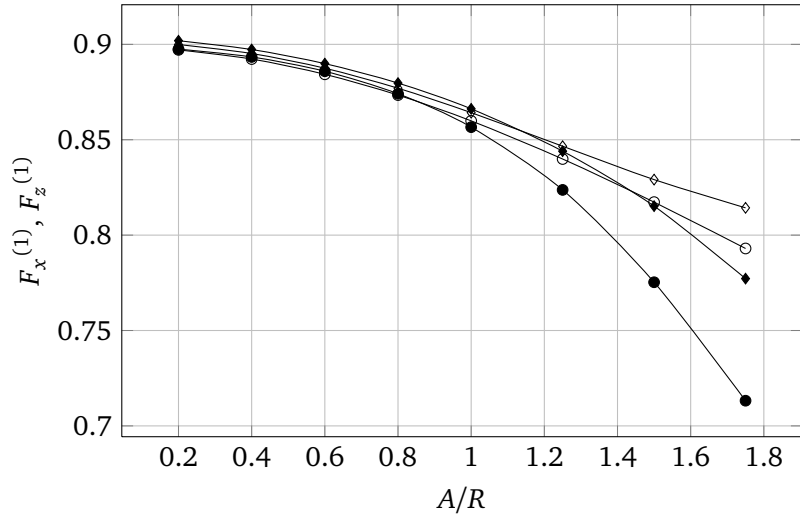

FIGURE 4.15 – 1st harmonic amplitude of the non-dimensional vertical (◆) and horizontal (◇) forces with $kR = 0.5$, compared to Wu's (1993) analytical theory (●, ○).

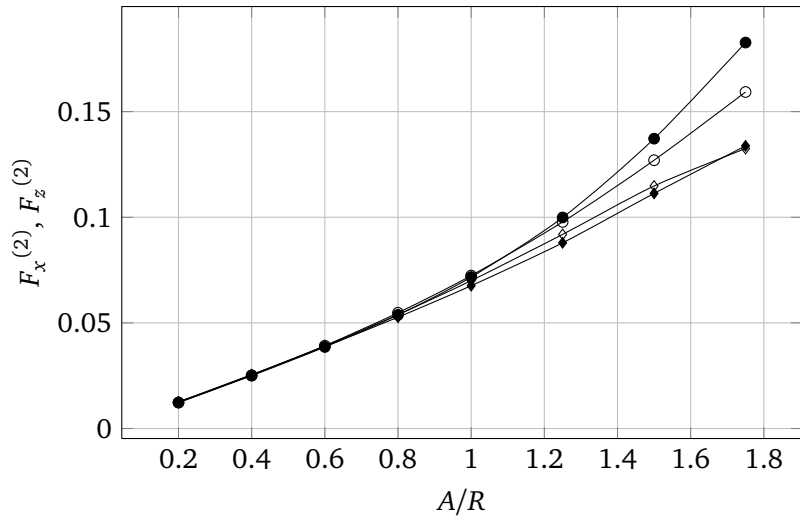

FIGURE 4.16 – 2nd harmonic amplitude of the non-dimensional vertical (◆) and horizontal (◇) forces with $kR = 0.5$, compared to Wu's (1993) analytical theory (●, ○).

4.6 Summary and intermediate conclusions from the chapter

We presented various two-dimensional numerical test cases involving a submerged circular cylinder, either fixed, or in a prescribed motion. We proved that in situations involving wave generation, wave reflection and nonlinear wave interactions, the developed model will conserve fluid volume with a good precision, provided that the free surface is sufficiently refined. In a second part, the diffraction forces and radiation forces computed by the numerical model were compared to linear or first-order theories with a good agreement. When the cylinder describes large amplitude motions, a discrepancy was observed with Wu's analytical results [80], due to its assumption of a linearized free surface. The hydrodynamic part of the model is now validated for wave radiation and diffraction by a submerged circular cylinder, and the next chapter is dedicated to validation for freely-moving circular cylinders. The implicit wave-body coupling described in chapter 2 will now be tested.

Validation of the numerical model for freely-moving horizontal circular cylinders

Le modèle 2DV-NWT est maintenant testé sur des cas de mouvements libres de cylindre circulaire, soumis aux efforts de pression hydrodynamique et à des efforts de rappel élastique et/ou d'amortissement linéaire. Dans un premier temps, on vérifie la bonne conservation de l'énergie totale du système {fluide+cylindre} sur le cas d'un cylindre pilonnant dans un canal au repos, avec une force de rappel élastique. La conservation du volume de fluide dans le canal est aussi vérifiée. Dans un second temps, on compare les résultats du modèle à la théorie linéaire d'Evans en profondeur infinie sur le cas du cylindre circulaire absorbant appelé cylindre de Bristol. Les efforts hydrodynamiques, la trajectoire du cylindre et l'efficacité d'absorption issus du modèle sont comparés aux résultats d'Evans en vagues périodiques, et l'influence de la non-linéarité des vagues est testée. Enfin, on présente les essais effectués en canal sur un système houlomoteur cylindrique, et les mesures sont comparées au modèle non-linéaire qui inclut une force de traînée visqueuse dans la dynamique du cylindre.

Contents

5.1	Introduction and scope of the chapter	52
5.2	A cylinder with a vertical elastic restoring force	52
5.3	Comparison to the theoretical linear model of the Bristol cylinder	61
5.4	Comparaison à des essais en canal à houle	80
5.5	Summary and intermediate conclusions from the chapter	92

5.1 Introduction and scope of the chapter

The previous chapter has shown the 2DV-NWT's capabilities in modelling wave diffraction and radiation by a submerged circular cylinder, moving with either small or large amplitude displacements. We now verify, also in two dimensions, its ability to simulate free motions of a submerged circular cylinder, restrained by linear elastic restoring forces and submitted to linear damping forces. Unlike the previous chapter, the wave-body coupling mathematically described in subsection 2.7.2 will now be put to test. Due to the cylinder circularity, angular momentum will equal zero in all the following simulations, so the body will not rotate about its center of mass. Simulations with a cylinder of rectangular cross-section, rotating about its center of mass, were made with the 2DV-NWT by Chachereau during his master's thesis [18], but will not be illustrated here.

First, we will investigate the ability of our 2DV-NWT to conserve the total energy in the computational domain on a simple configuration with a freely-heaving cylinder submerged in a tank of limited length with lateral reflective walls. Numerical computations will then be performed on a cylindrical wave-energy converter in infinite water depth, called the Bristol Cylinder, and results will be compared to Evans et al. linear predictions [28]. We will analyze the nonlinear effects caused by increasing the wave steepness on the cylinder trajectory and efficiency, in regular waves. Finally, some experiments performed in the tank of University of Rhode Island (USA) on a cylindrical wave-energy converter anchored to the seabed by a linear power take-off will be presented and the measured Response Amplitude Operators (RAOs) in regular waves will be compared to numerical results by adding a viscous drag force into the cylinder dynamics.

5.2 A cylinder with a vertical elastic restoring force

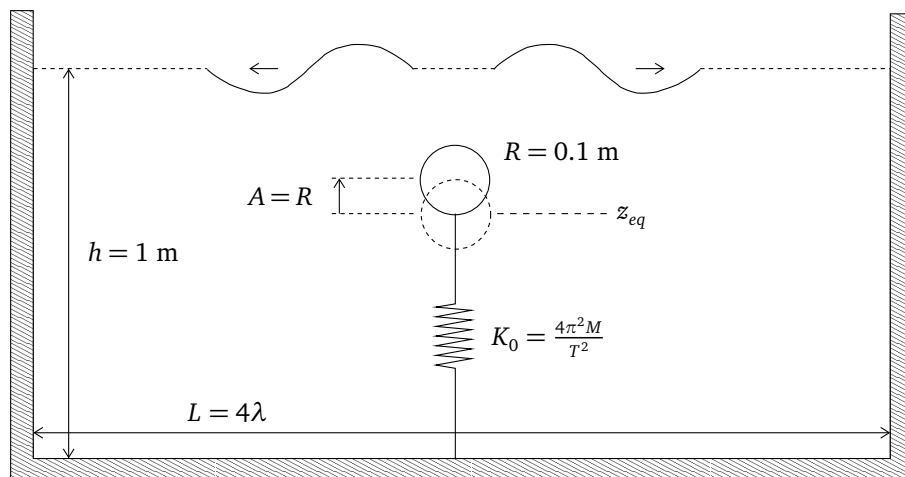

FIGURE 5.1 – Sketch of problem geometry for a freely heaving cylinder of radius $R = 0.1$ m, following an initial vertical displacement $A = R$, in water of depth $h = 1$ m. The cylinder is anchored to the bottom of the tank by a spring of stiffness K_0 .

As sketched in Fig. 5.1, we now consider a neutrally buoyant cylinder of radius $R = 0.1$ m and mass $M = \rho \pi R^2$ per unit length, anchored to the bottom of the tank by a vertical spring

of stiffness K_0 and negligible mass. The water depth is $h = 10R = 1$ m. The cylinder can only move vertically (one single d.o.f., in heave) and has its equilibrium position at depth z_{eq} under the free surface at rest. Spring extension is zero at the equilibrium position of the cylinder. Neglecting added mass and treating this system as a point oscillator, we find its period of (vertical/heave) oscillation as,

$$T = 2\pi\sqrt{\frac{M}{K_0}} \quad (5.1)$$

Eq. (5.1) is used to obtain the vertical spring stiffness K_0 by fixing the period T of cylinder oscillation a priori through,

$$K_0 = 4\pi^2\frac{M}{T^2} \quad (5.2)$$

At $t = 0$, the cylinder is pulled up from its equilibrium position by a distance $A = R$, and released with a zero initial velocity. The cylinder then freely oscillates vertically in heave, around z_{eq} , under the combined action of the hydrodynamic forces from generated waves and of the spring restoring force. Similar to the problem of forced motion considered in section 4.2, the length of the tank is set to four times the wavelength λ predicted by the linear dispersion relation (Eq. (4.1)), here, based on the theoretical cylinder heave period T .

5.2.1 Mathematical formulation of volume and energy conservation

The displaced cylinder initially gains potential and elastic energy, so that its total initial energy is $E_{co} = Mg(A + z_{eq} + h) + K_0A^2/2$ (with the energy reference level being the tank bottom $z = -h$). Upon release this energy is gradually transferred to the wave motion caused by the cylinder oscillations; the cylinder initially generates symmetric waves, which propagate in both directions away from the cylinder. After reflecting off the sidewalls and propagating back to the cylinder location, these waves transfer part of their energy back to the cylinder. Since no damping is applied to the cylinder nor to the water, the total mechanical energy of the {fluid + cylinder} system must remain constant. We verify this energy conservation principle by considering two cases, with equilibrium depths $z_{eq} = -4R = -0.4$ m and $z_{eq} = -3R = -0.3$ m. The spring stiffness is calculated here with Eq. (5.2) choosing $T = 0.8$ s. The wavelength λ predicted by Eq. (4.1) equals here 1.0 m.

Denoting by $z_c(t)$ the elevation of the center of mass of the cylinder, its instantaneous total mechanical energy is found as the sum of potential, elastic, and kinetic energies as,

$$E_c(t) = Mg(z_c(t) + h) + \frac{1}{2}K_0(z_c(t) - z_{eq})^2 + \frac{1}{2}M\dot{z}_c(t)^2 \quad (5.3)$$

Similarly the total mechanical energy of the fluid is expressed as the sum of its potential and kinetic energies as,

$$E_f(t) = \frac{1}{2}\rho g \int_{\Gamma(t)} (z + h)^2 d\Gamma + \frac{1}{2}\rho \int_{\Gamma(t)} \phi \frac{\partial \phi}{\partial n} d\Gamma \quad (5.4)$$

Denoting by $E(t) = E_f(t) + E_c(t)$ the total energy and $E_0 = E(t = 0) = E_{co} + E_{fo}$ the initial energy of the system {fluid + cylinder} just before releasing the cylinder, the relative error ϵ_e on energy conservation is expressed as,

$$\epsilon_e(t) = \frac{E(t) - E_0}{E_0} \quad (5.5)$$

The relative error ϵ_v on fluid volume conservation is defined here as,

$$\epsilon_v(t) = \frac{V(t) - V_0}{V_0} \quad (5.6)$$

In the following results, $\bar{\epsilon}_e(t)$ and $\bar{\epsilon}_v(t)$ will denote the moving average of $\epsilon_e(t)$ and $\epsilon_v(t)$, respectively, over a time interval T .

Finally, we express the energy exchange between the fluid and the cylinder over one time step, as the work W_p of the hydrodynamic pressure forces \mathbf{F}_p on the cylinder, calculated as the integral of the power exchanged over one time step :

$$W_p(t) = \int_t^{t+\Delta t} \mathbf{F}_p \cdot \dot{\mathbf{x}} dt \quad (5.7)$$

and, in the following, $\bar{W}_p(t)$ will denote a moving average of $W_p(t)$ over a time interval T .

5.2.2 Numerical applications

In the BEM, 60 nodes are used on the cylinder boundary and $N_f = 50$ nodes per wavelength on the free surface. For the two tested submergence depths, Figs. 5.2 and 5.3 show time series of the vertical position of the cylinder, the fluid and cylinder mechanical energy variations with reference to their initial values at $t = 0$, the work done by the fluid on the cylinder and the error in energy conservation of the total system {fluid + cylinder}, as a function of non-dimensional time t/T .

Based on these results, we can summarize the cylinder behavior as follows. Given its initial energy, upon release, the cylinder first oscillates in heave around its equilibrium depth, up to $t/T \approx 10$ for $z_{eq} = -0.4$ m and $t/T \approx 7$ for $z_{eq} = -0.3$ m. During this time, a transfer of energy occurs from the cylinder to the fluid, as seen on the first, second and third plots in Figs. 5.2 and 5.3 in the decreasing amplitude of cylinder oscillation, the increasing fluid energy and negative mean work \bar{W}_p of the hydrodynamic pressure force, respectively. This is the time interval during which symmetric waves are generated, which propagate towards the tank sidewalls. When these waves reflect back to the cylinder, the amplitude of cylinder motion starts increasing again, up to reaching a value close to its initial amplitude A .

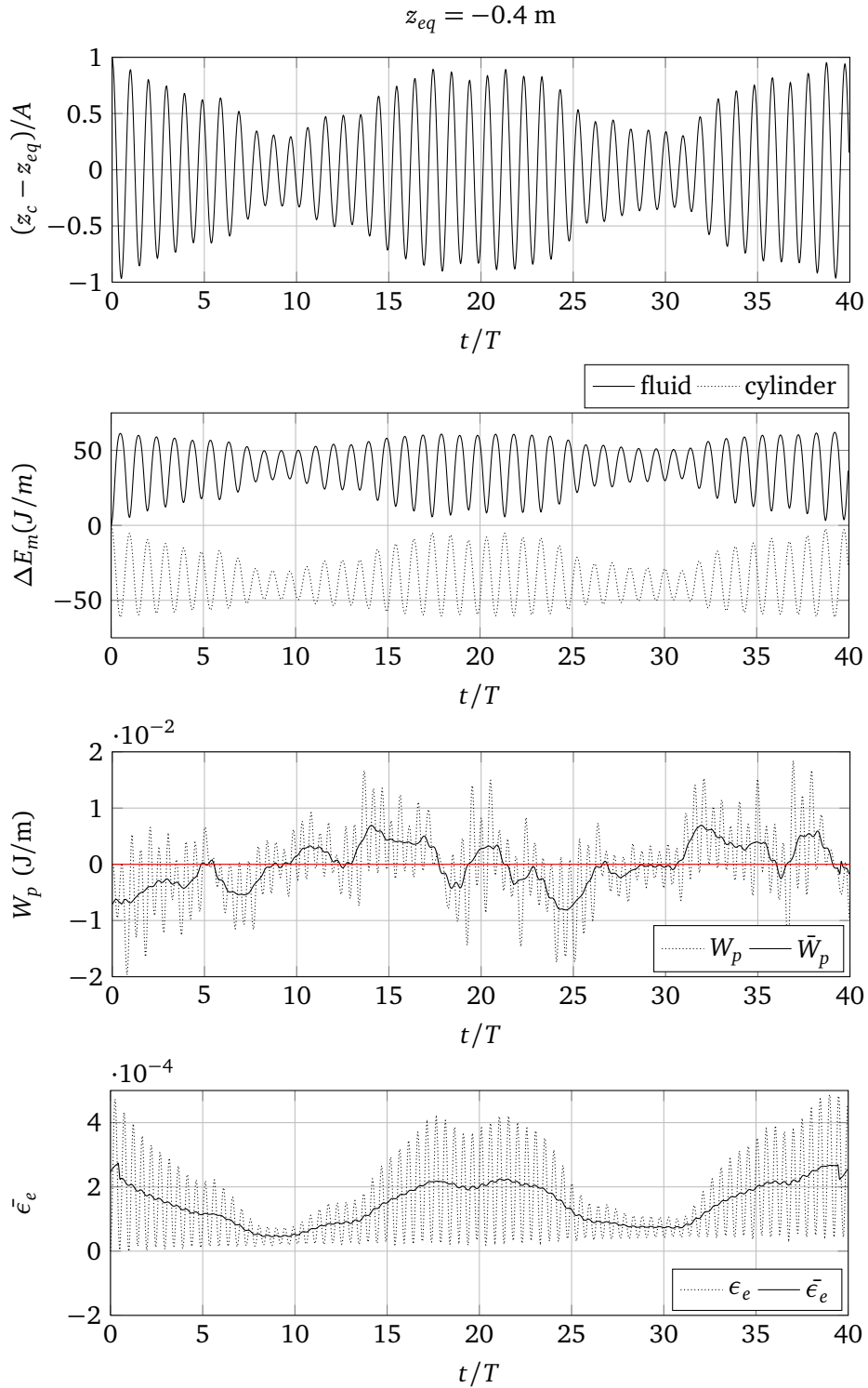

FIGURE 5.2 – For submergence depth $z_{eq} = -0.4 \text{ m}$, from top to bottom, non-dimensional vertical position of the cylinder from equilibrium depth, fluid and cylinder mechanical energy variations, work done by the fluid on the cylinder, error in energy conservation of the total system {fluid + cylinder}, as a function of non-dimensional time t/T .

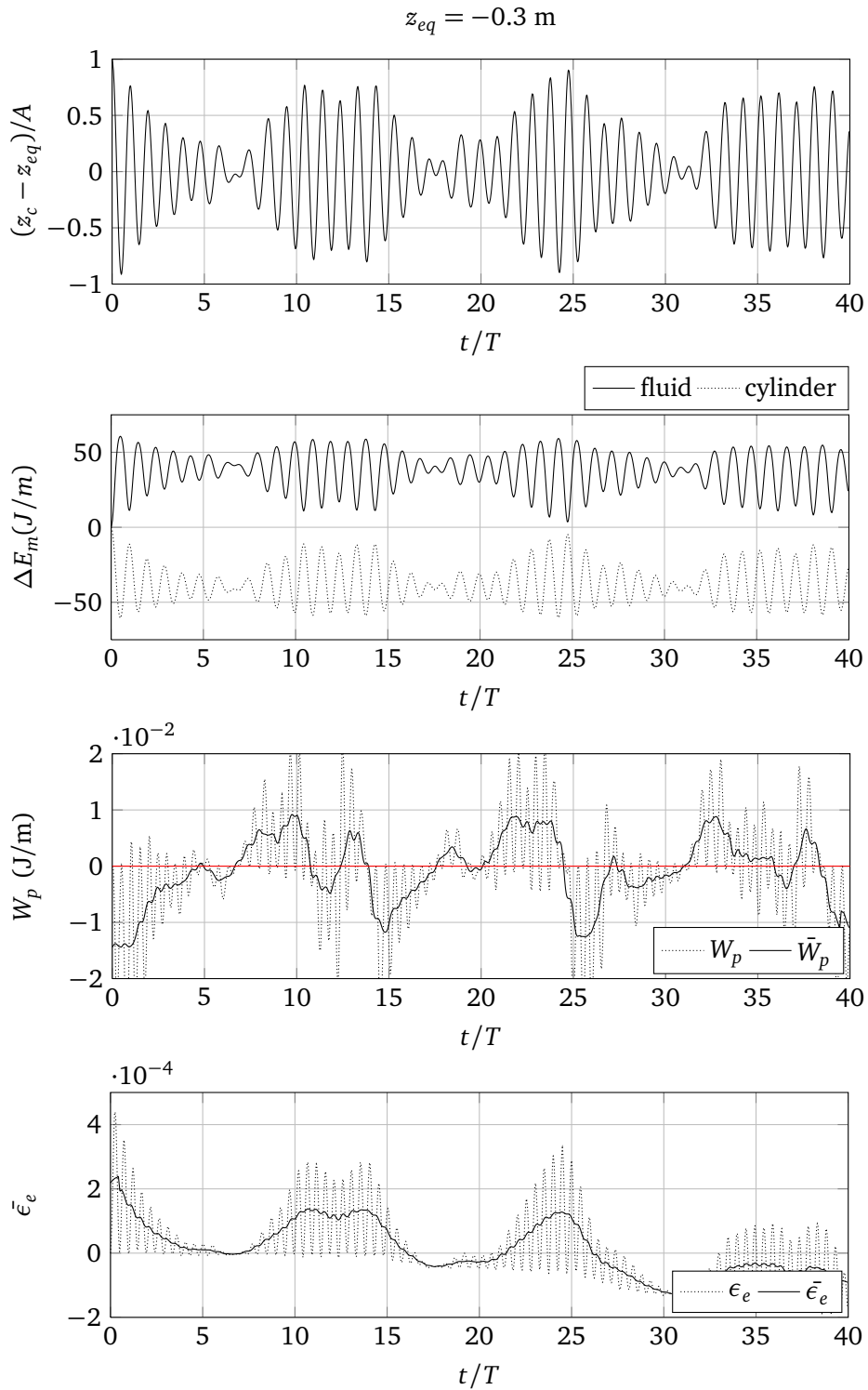

FIGURE 5.3 – For submergence depth $z_{eq} = -0.3 \text{ m}$, from top to bottom, non-dimensional vertical position of the cylinder from equilibrium depth, fluid and cylinder mechanical energy variations, work done by the fluid on the cylinder, error in energy conservation of the total system {fluid + cylinder}, as a function of non-dimensional time t/T .

This second phase, between $t/T \approx 10$ and $t/T \approx 20$ for $z_{eq} = -0.4$ m, and $t/T \approx 7$ and $t/T \approx 14$ for $z_{eq} = -0.3$ m, corresponds to a transfer of energy from the fluid to the cylinder, which is confirmed in the energy plots and by the positive \bar{W}_p values. A new train of waves is then generated, corresponding to energy being transferred back to the fluid, and so forth. At least two full cycles of this dynamics can be seen in Figs. 5.2 and 5.3, whose periodicity depends on the submergence depth (about $20T$ for $z_{eq} = -0.4$ m and $12T$ for $z_{eq} = -0.3$ m). In both cases, the maximum error on energy conservation $\bar{\epsilon}_e$ is less than $\sim 0.03\%$, and this error is larger when the amplitude of the cylinder motion is maximum. Also, in general, this error is larger when energy is transferred from the fluid to the cylinder ($\bar{W}_p > 0$) and smaller when energy is transferred the other way around ($\bar{W}_p < 0$). This might be due to the fact that there is a loss of accuracy in the BEM when the cylinder has larger amplitude motion and gets closer to the free surface. Note, this effect could be alleviated by either refining the free surface discretization or using subdivisions in the BEM numerical integrations of quasi-singular terms.

Figs. 5.4 and 5.5 show the number N_i of sub-iterations required to reach convergence in the predictor-corrector scheme used to calculate the hydrodynamic pressure force at the next iteration (see section 3.4.1), for each submergence depth. Convergence is considered to be reached when the relative error on the hydrodynamic forces between two iterations is less than 10^{-6} . The figure also shows the actual convergence error $\epsilon_{\mathcal{F}}$, which in general is much less than this threshold. Only 1 or 2 sub-iterations are typically needed to achieve convergence.

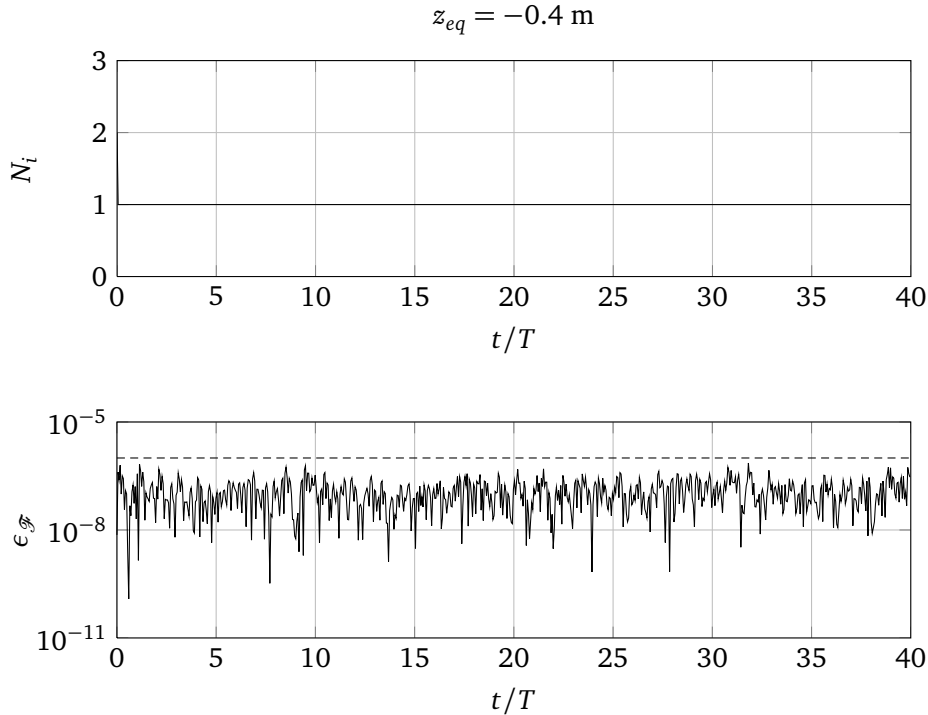

FIGURE 5.4 – Case of Fig. 5.1, for submergence depth $z_{eq} = -0.4$ m. Time series of the number N_i of sub-iterations required to achieve convergence of the body hydrodynamic pressure force, and relative error $\epsilon_{\mathcal{F}}$ on the latter at convergence; the 10^{-6} convergence threshold is marked on the figure (---).

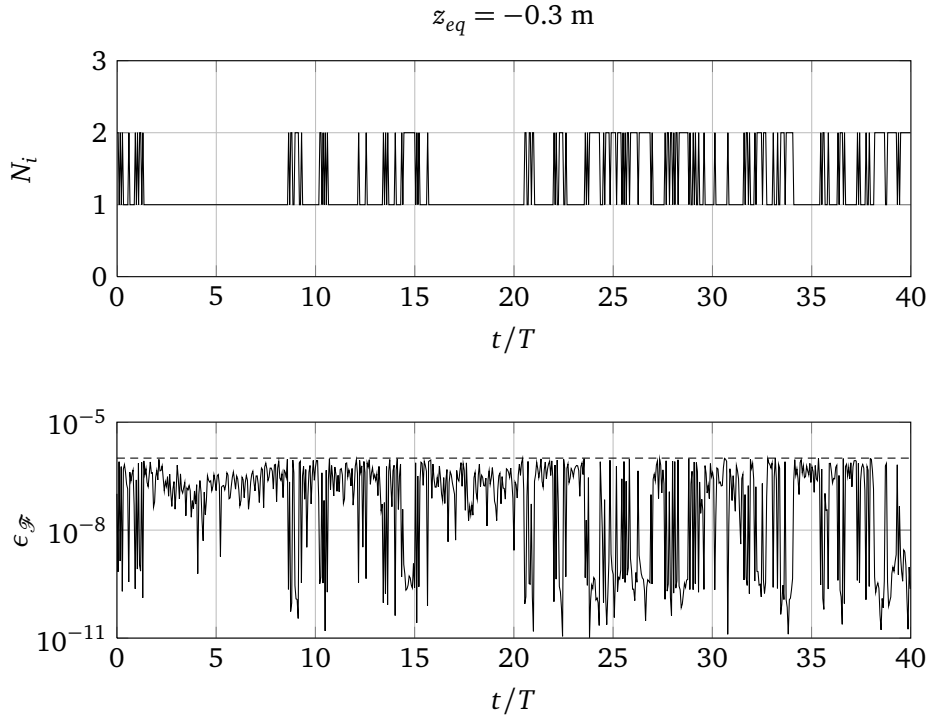

FIGURE 5.5 – Case of Fig. 5.1, for submergence depth $z_{eq} = -0.3 \text{ m}$. Time series of the number N_i of sub-iterations required to achieve convergence of the body hydrodynamic pressure force, and relative error ϵ_f on the latter at convergence ; the 10^{-6} convergence threshold is marked on the figure (---).

Eventually Figs. 5.6 and 5.7 show time series of mean energy $\bar{\epsilon}_e$ and fluid volume $\bar{\epsilon}_v$ conservation errors, successively using four discretization steps on the free surface boundary, yielding $N_f = \lambda/\Delta x = 15, 25, 50, 75$ nodes per wavelength. 40 nodes are used on the cylinder boundary in each case. Refining the mesh on the free surface clearly improves the accuracy of the BEM model and overall computations, particularly when the cylinder has larger oscillations and is closer to the free surface. Comparison of Figs. 5.6 and 5.7 also show that a change in cylinder submergence depth has a larger influence on volume conservation error than on energy conservation error.

As a concluding remark of this first series of tests with a freely-moving cylinder, the numerical model exhibits very good conservation capabilities, both for the fluid volume and the total mechanical energy of the system. For $z_{eq} = -0.4 \text{ m}$, typical relative errors on fluid volume and total mechanical energy are $O(0.001\%)$ and $O(0.01\%)$ respectively, for the adopted discretization steps, after 40 periods of oscillation.

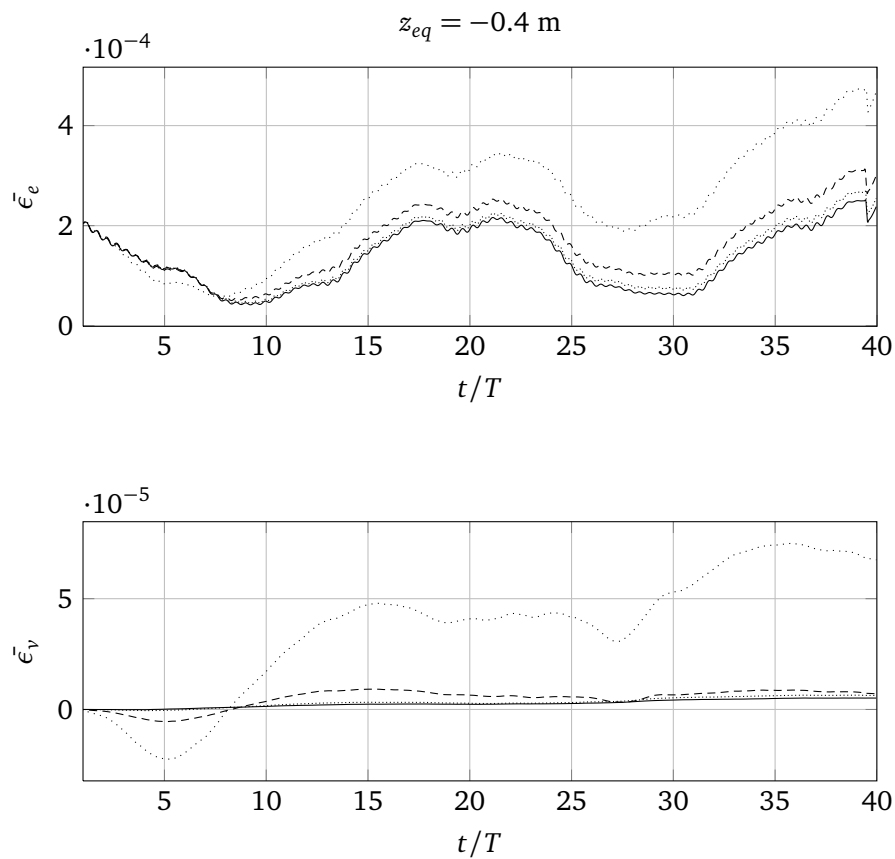

FIGURE 5.6 – Case of Fig. 5.1, for submergence depth $z_{eq} = -0.4$ m. Time series of mean energy and volume conservation errors ($T = 0.8$ s). Numerical results are shown for four spatial discretization steps on the free surface boundary with : $N_f = \lambda/\Delta x = 15$ (.....), $N_f = 25$ (----), $N_f = 50$ (-.....), $N_f = 75$ (—).

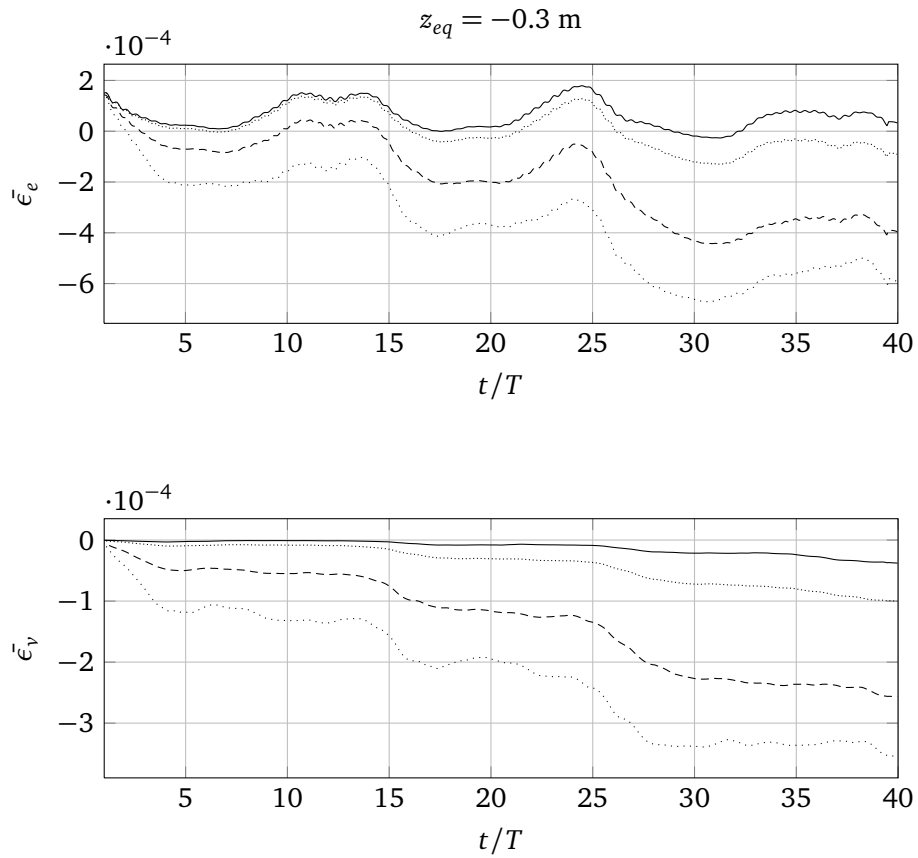

FIGURE 5.7 – Case of Fig. 5.1, for submergence depth $z_{eq} = -0.3 \text{ m}$. Time series of mean energy and volume conservation errors ($T = 0.8 \text{ s}$). Numerical results are shown for four spatial discretization steps on the free surface boundary with : $N_f = \lambda/\Delta x = 15$ (.....), $N_f = 25$ (----), $N_f = 50$ (-·-·-·), $N_f = 75$ (—).

5.3 Comparison to the theoretical linear model of the Bristol cylinder

In the previous section, we verified that provided the BEM discretization is fine enough, very small errors on volume and energy conservation can be achieved, for long computational times, in situations where the submerged cylinder is freely heaving in the wave tank and waves reflect off the sidewalls. This is a very important result for modelling WECs and accurately predicting the efficiency of WECs undergoing large amplitude motions. In this section, we study the ability of our model to reproduce the behavior of an idealized WEC : the so-called “Bristol cylinder”, introduced and studied in the late 1970s by Evans et al. (e.g., [27, 28]). This case will serve as a more demanding and realistic test case of our model’s predictive capabilities.

5.3.1 La théorie linéaire d’Evans

Evans [27] considère un système houlomoteur constitué d’un cylindre rigide totalement immergé, de section circulaire de rayon R , de flottabilité neutre (i.e. de masse $M = \rho \pi R^2$ par unité de longueur), et rattaché à deux générateurs linéaires identiques dans les directions horizontale et verticale. Ces générateurs induisent des efforts que l’on modélise par des forces de rappel élastique de raideur K et des forces d’amortissement visqueux de coefficient D . Ce système, initialement au repos, est soumis à des vagues périodiques d’amplitude A et de pulsation ω , qui induisent une force hydrodynamique par unité de longueur notée $F_h = (F_{h1}, F_{h2})$. Evans se place dans le cadre de la théorie potentielle linéaire, et suppose le domaine infini dans les directions horizontale et verticale (profondeur infinie).

En notant $\mathbf{x} = (x_1, x_2)$ le déplacement du centre de gravité du cylindre par rapport à sa position d’équilibre qui est aussi sa position initiale, l’équation de la dynamique du centre de gravité du cylindre projetée sur la direction i s’écrit :

$$M\ddot{x}_i = F_{hi} - D\dot{x}_i - Kx_i \quad (5.8)$$

Evans et al. [28] cherchent les solutions harmoniques de cette équation sous la forme :

$$x_i = \text{Re}\{\hat{X}_i e^{i\omega t}\} \quad (5.9)$$

où \hat{X}_i est *a priori* complexe.

Expression des efforts hydrodynamiques

Dans le cadre de la théorie linéaire, la force hydrodynamique F_h peut être décomposée en la somme des efforts d’excitation F_e (efforts exercés par les vagues incidentes sur le corps lorsque celui-ci est supposé fixe) et des efforts de radiation F_R (efforts exercés par le fluide environnant sur le corps lorsque celui-ci décrit un mouvement forcé de faible amplitude). Ainsi Evans écrit :

$$F_h = F_e + F_R \quad (5.10)$$

Lorsque le cylindre décrit une oscillation de pulsation ω dans la direction verticale, la i -ème composante des efforts de radiation se décompose linéairement en fonction de la vitesse \dot{x}_i et de l’accélération \ddot{x}_i du corps dans la direction du mouvement, sous la forme :

$$F_{Ri} = -a_{ii}(\omega)\dot{x}_i - b_{ii}(\omega)\ddot{x}_i \quad (5.11)$$

où $a_{ii}(\omega)$ et $b_{ii}(\omega)$ désignent respectivement les coefficients de masse ajoutée et d'amortissement linéaire en radiation du cylindre dans la direction i , à la pulsation ω . La formulation harmonique complexe des efforts de radiation s'écrit alors :

$$F_{Ri} = \text{Re} \left\{ \hat{F}_{Ri} e^{i\omega t} \right\} \quad \hat{F}_{Ri} = (\omega^2 a_{ii}(\omega) - i\omega b_{ii}(\omega)) \hat{X}_i \quad (5.12)$$

En s'appuyant sur les travaux d'Haskind [46] et Newman [63], Evans propose également une expression de l'amplitude des efforts d'excitation en fonction du coefficient d'amortissement en radiation $b_{ii}(\omega)$ et de l'amplitude A des vagues incidentes, sous la forme :

$$F_{ei} = \text{Re} \left\{ \hat{F}_{ei} e^{i\omega t} \right\} \quad \hat{F}_{ei} = \rho g A \sqrt{\frac{b_{ii}(\omega)}{\rho \omega}} e^{i\delta_i} \quad (5.13)$$

où δ_i est le déphasage entre la vague radiée à l'infini et l'oscillation forcée du cylindre dans la direction i .

Solution harmonique

En utilisant (5.9), (5.10), (5.12) et (5.13), l'équation (5.8) s'écrit finalement :

$$\hat{Z}_i \hat{X}_i = \hat{F}_{ei} \quad (5.14)$$

avec

$$\hat{Z}_i(\omega) = K - \omega^2 (M + a_{ii}(\omega)) + i\omega(D + b_{ii}(\omega)) = |\hat{Z}_i(\omega)| e^{i\chi_i} \quad (5.15)$$

χ_i est le terme de phase de la quantité complexe $\hat{Z}_i(\omega)$. La solution harmonique s'écrit alors :

$$\hat{X}_i = C_i e^{i\alpha_i} \quad (5.16)$$

avec

$$C_i = \rho g A \sqrt{\frac{b_{ii}(\omega)}{\rho \omega}} |\hat{Z}_i(\omega)|^{-1} \quad (5.17)$$

$$\alpha_i = \delta_i - \chi_i \quad (5.18)$$

A l'aide des équations (5.10), (5.14) et (5.16), on exprime alors la force totale hydrodynamique $F_{hi} = \text{Re} \left\{ \hat{F}_{hi} e^{i\omega t} \right\}$ agissant sur le cylindre sous la forme :

$$\hat{F}_{hi} = \hat{F}_{ei} + \hat{F}_{Ri} = \left[\hat{Z}_i(\omega) + \omega^2 a_{ii}(\omega) - i\omega b_{ii}(\omega) \right] \hat{X}_i \quad (5.19)$$

$$= C_i (K - M\omega^2 + i\omega D) e^{i\alpha_i} \quad (5.20)$$

Dans le cas général, la solution harmonique (5.16) correspond à une trajectoire elliptique centrée sur la position initiale d'équilibre du système, et dont l'orientation dépend du déphasage $\alpha_2 - \alpha_1$. Or Ursell [77] puis Ogilvie [65] ont montré analytiquement, en utilisant la

théorie potentielle linéaire, que les vagues rayonnées à l'infini par les oscillations horizontales et verticales d'un cylindre horizontal de section circulaire sont d'amplitudes égales et déphasées de $\pi/2$. Cette propriété a notamment pour conséquence qu'un cylindre décrivant une trajectoire circulaire ne génère des vagues que dans une seule direction. Cela a également pour conséquence qu'il n'y a pas de réflexion des vagues par un cylindre fixe et que les coefficients hydrodynamiques du cylindre sont égaux en cavement et en pilonnement. On en déduit donc que d'une part, $\hat{Z}_1 = \hat{Z}_2 = \hat{Z}$ et $C_1 = C_2 = C$ et d'autre part $\alpha_2 = \alpha_1 + \pi/2$. Ainsi, dans le cas du cylindre de section circulaire, la solution harmonique (5.16) correspond à une trajectoire circulaire centrée sur la position d'équilibre du système, dont le rayon C est donné sous forme adimensionnelle par :

$$\frac{C}{A} = \rho g \sqrt{\frac{b_{ii}(\omega)}{\rho \omega}} |\hat{Z}(\omega)|^{-1} \quad (5.21)$$

Réglage du système

De même que la trajectoire, la puissance moyenne absorbée par le système sur une période peut être calculée analytiquement. En notant W le travail des efforts d'amortissement des deux générateurs, la puissance moyenne absorbée au cours d'une période de vagues vaut :

$$P_{abs} = \frac{\omega}{2\pi} \int_0^{2\pi/\omega} W dt = \frac{1}{2} \sum_{i=1}^2 DC_i^2 \omega^2 = DC^2 \omega^2 \quad (5.22)$$

La puissance moyenne des vagues incidentes valant $1/4\rho\omega g^2 A^2$ en profondeur infinie, on définit l'efficacité E du système comme le rapport de la puissance moyenne absorbée au cours d'une période par la puissance moyenne des vagues incidentes, qui vaut alors, d'après la théorie linéaire d'Evans :

$$E(\omega) = \frac{4Db_{ii}(\omega)}{|\hat{Z}(\omega)|^2} \quad (5.23)$$

Pour une pulsation donnée ω_0 , on notera que cette efficacité est maximale pour le choix du couple (K, D) suivant :

$$K_0 = \{M + a_{ii}(\omega_0)\} \omega_0^2 \quad (5.24)$$

$$D_0 = b_{ii}(\omega_0) \quad (5.25)$$

ce qui correspond à une efficacité de 1, c'est-à-dire à une absorption totale de la houle incidente de pulsation ω_0 . Ce résultat a été démontré par Evans [27] et indépendamment par Mei [61].

Dans la suite, on s'attache à vérifier numériquement les résultats théoriques d'Evans sur la trajectoire et l'efficacité du système.

5.3.2 Numerical results for quasi-linear and nonlinear periodic waves

We now simulate one of the configurations studied by Evans et al. [28], namely a neutrally buoyant circular cylinder of radius $R = 0.05$ m, whose center is initially at a submergence depth $z_c = -1.25R = -0.0625$ m (i.e., there is $0.75R = 1.25$ cm of water above the top of the cylinder at rest). The device is placed in a tank of depth h and tuned to a particular pulsation ω_0 , which corresponds to a given choice of generator parameters (K_0, D_0) computed from Eqs. (5.24) and (5.25). An absorbing beach is implemented at the end of the tank over four times the wavelength λ , based on the linear dispersion relation (Eq. 4.1). Figure 5.8 illustrates the problem geometry.

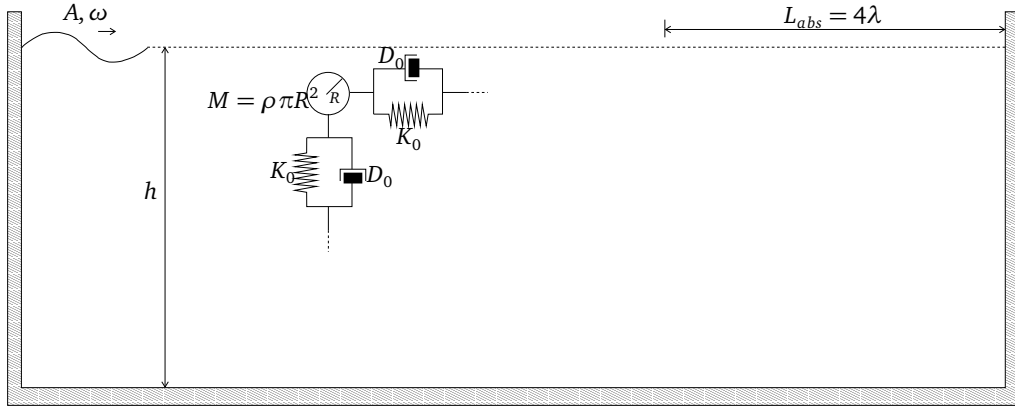

FIGURE 5.8 – Sketch of problem geometry : the tuned Bristol cylinder device is submitted to regular waves of pulsation ω and amplitude A in a flume of depth h . An absorbing beach is set at the end of the tank over a length of four times the wavelength.

We simulate the action of incident periodic waves of height $H = 2A$ and pulsation ω on the cylinder, in order to compare our results for the hydrodynamic forces, trajectory of the center of mass and efficiency of the device with Evans linear solution. We consider a wide range of frequencies (from $\omega = 4$ rad/s to $\omega = 18$ rad/s) which corresponds respectively to long waves ($\lambda = 3.85$ m) and short waves ($\lambda = 0.19$ m), as compared to the cylinder dimensions. Depth h of the tank is chosen such as $kh \approx 25$ for every frequency, in order to largely satisfy the infinite depth condition for the incident waves ($kh > \pi$) and minimize the influence of the bottom of the tank on the flow around the cylinder. Five values of incident wave steepness H/λ are considered and H is adaptively set for each frequency. Due to the very closeness of the cylinder near the free surface (there is 1.25 cm between the top of the cylinder and the free surface at rest), a maximum wave steepness of 1 % was considered in order to prevent waves from breaking and the cylinder from piercing the free surface. Numerical results will hopefully be close to Evans analytical solutions for the lowest wave steepnesses. Wave characteristics, such as pulsation ω and corresponding wave height H for a given steepness H/λ , are summarized in table 5.1.

First of all, in order to plot Evans et al.'s harmonic solution to compare with our numerical results, the hydrodynamical coefficients of the cylinder need to be computed. This is done in the following by computing the vertical and horizontal forces on the cylinder when it moves in a specified heaving oscillation and a specified swaying motion, respectively. A good comparison is drawn with Frank's linear numerical results [31]. This will validate the formulation of

5.3. Comparison to the theoretical linear model of the Bristol cylinder

ω (rad/s)	h (m)	kR	H (m) for various wave steepnesses H/λ				
			0.05%	0.10%	0.20%	0.50%	1.00%
4	15.5	0.08	0.001926	0.00385	0.00770	0.01926	0.03852
5	10.0	0.13	0.001233	0.00247	0.00493	0.01233	0.02466
6	7.00	0.18	0.000856	0.00171	0.00342	0.00856	0.01712
7	5.10	0.25	0.000629	0.00126	0.00252	0.00629	0.01258
8	3.90	0.33	0.000482	0.00096	0.00193	0.00482	0.00963
9	3.10	0.41	0.000380	0.00076	0.00152	0.00380	0.00761
10	2.50	0.51	0.000308	0.00062	0.00123	0.00308	0.00616
11	2.04	0.62	0.000255	0.00051	0.00102	0.00255	0.00509
12	1.72	0.73	0.000214	0.00043	0.00086	0.00214	0.00428
13	1.46	0.86	0.000182	0.00036	0.00073	0.00182	0.00365
14	1.26	1.00	0.000157	0.00031	0.00063	0.00157	0.00314
15	1.10	1.15	0.000137	0.00027	0.00055	0.00137	0.00274
16	0.97	1.30	0.000120	0.00024	0.00048	0.00120	0.00241
17	0.86	1.47	0.000107	0.00021	0.00043	0.00107	0.00213
18	0.77	1.65	0.000095	0.00019	0.00038	0.00095	0.00190

TABLE 5.1 – Depth h of the tank and wave height H for each wave steepness H/λ and each wave angular frequency ω .

the radiation forces (Eq. (5.11)) in the present configuration. Exciting forces are then numerically evaluated on the cylinder, when held in a fixed position. Those are compared to Evans formulation (Eq. (5.13)), using the damping coefficients previously obtained for the radiation.

The effect of wave steepness will be considered in order to analyze the impact of wave nonlinearity on the zeroth, first-, second- and third-order horizontal and vertical forces. Simulations will finally be performed for the freely-moving tuned cylinder and results on the total hydrodynamic forces, trajectory of the cylinder and efficiency of the device will be presented for incident waves of various steepnesses and compared to Evans et al.'s predictions.

Computation of the hydrodynamical coefficients of the cylinder

In the linear approach, radiation forces can be expressed as a function of the acceleration and velocity of the body center of mass. Considering a cylinder in a specified heaving motion, the vertical force is usually expressed as,

$$F_z = -a_{zz}\ddot{z}_G - b_{zz}\dot{z}_G \quad (5.26)$$

a_{zz} and b_{zz} being respectively the linear added-mass and radiation damping coefficients of the heaving structure. Specifying a heave of amplitude A and frequency ω , such as $z_G(t) = A \sin \omega t$, the vertical radiation force takes the form :

$$F_z = a_{zz}(\omega)A\omega^2 \sin \omega t - b_{zz}(\omega)A\omega \cos \omega t \quad (5.27)$$

If we denote $a_1(F_z)$ and $b_1(F_z)$ the 1st-order (real) coefficients of the Fourier decomposition of F_z , then can the hydrodynamic coefficients be expressed as :

$$a_{zz}(\omega) = \frac{b_1(F_z)}{A\omega^2} \quad (5.28)$$

$$b_{zz}(\omega) = - \frac{a_1(F_z)}{A\omega} \quad (5.29)$$

Based on a harmonic analysis of F_z , we now have access to the hydrodynamic coefficients in heave. This procedure can similarly be applied to a horizontal motion to compute the sway coefficients based on the signal of the horizontal force.

Numerical Application

We now intend to compute the hydrodynamical coefficients of the Bristol cylinder, as described in the previous section, for both heave and sway. The imposed cylinder motion and the ensuing wave motion have been simulated for the 15 different frequencies (see Tab. 5.1), ranging from $\omega = 4$ rad/s to $\omega = 18$ rad/s with increment $\Delta\omega = 1$ rad/s, and the calculations have been sustained about 8 cycles of motion with a very low amplitude ($A = 10^{-8}$ m) in order to minimize the influence of nonlinear effects. The numerical tests are carried out in a wave tank of variable dimensions, depending on the frequency of motion : the depth h of the tank is chosen such as $kh \approx 25$ for every frequency, in order to largely satisfy the infinite depth condition. Reflective walls are considered on the lateral boundaries. The total length of the tank is taken as 12 times the wavelength based on the linear dispersion relation (Eq. 4.1), so long enough to minimize the effect of spurious reflections on the selected part of time signals. The cylinder motion is progressively increased over the three first periods.

Figures 5.9 and 5.10 present the numerical results for the non-dimensional added mass and damping coefficients respectively, and the comparison with Frank's numerical results [31] based on a linear approach in fluid of infinite depth. Based on the recent linear analytical approach by Evans and Porter [29], Benoit also computed the corresponding coefficients, with a higher precision than Frank's data which were obtained by scanning by hand the plots published in [31]. This may explain the slight discrepancy with Frank's curve, probably due to the lack of precision of the hand scanning. Nevertheless we have an excellent agreement with Evans and Porter's predictions, a result which confirms the validity of the above-described method. These figures also show a very good consistency between sway and heave motions, a result analytically proved by Ursell [77].

These computed coefficients are now used in the following to evaluate Evans et al.'s analytical solution.

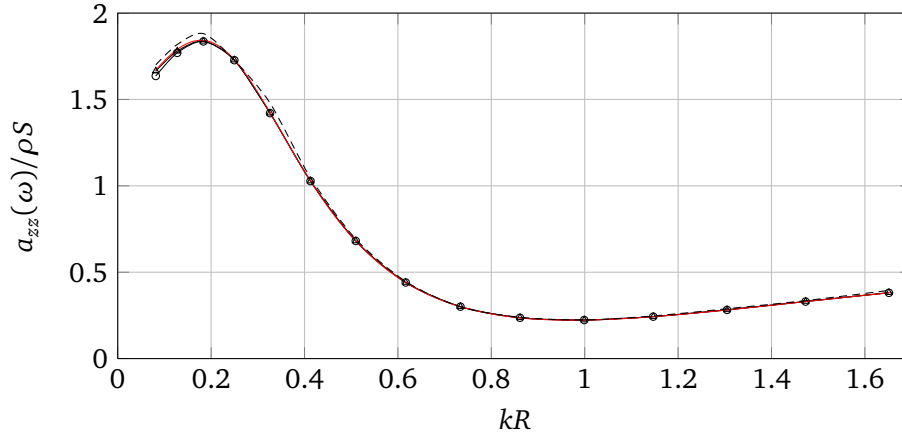

FIGURE 5.9 – Non-dimensional linear added-mass of the cylinder in sway (\circ) and heave (\triangle) computed by BEM, as compared to Frank’s linear results [31] (---), and Benoit’s computations (—) based on the linear analytical approach by Evans and Porter [29].

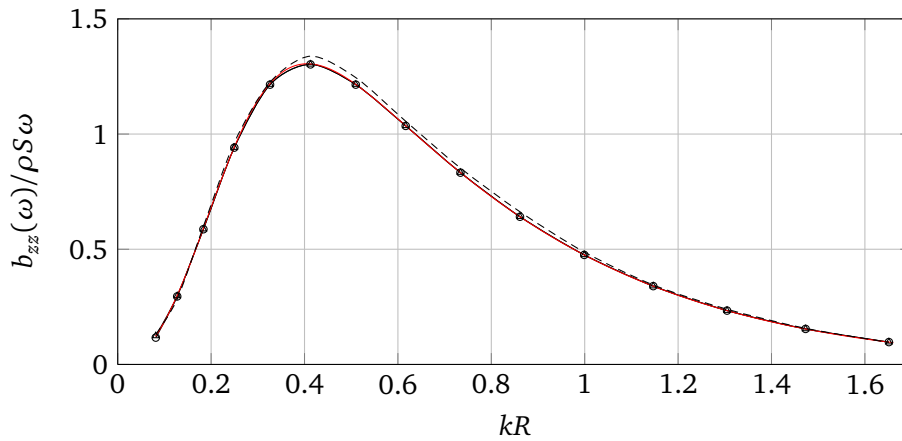

FIGURE 5.10 – Non-dimensional linear radiative damping of the cylinder in sway (\circ) and heave (\triangle) computed by BEM, as compared to Frank’s linear results [31] (---), and Benoit’s computations (—) based on the linear analytical approach by Evans and Porter [29].

Computation of the exciting forces

Based on Haskind [46] and Newman relations [63], Evans expressed the exciting forces as a function of the amplitude A of the incident waves and damping coefficients as given by Eq. (5.13). Forces on the fixed cylinder are numerically computed with the incident periodic waves of various steepnesses presented in Tab. 5.1. These waves are generated at the leftward boundary of the computational domain using the so-called Stream-function Method.

In each case, the horizontal and vertical components of the computed exciting force are made non-dimensional by the amplitude of the harmonic solution of Evans et al. (5.13) and then analyzed based on a Fourier decomposition,

$$\frac{F_x}{|\hat{F}_{e x}|} = F_x^{(0)} + \sum_{n \geq 1} F_x^{(n)} \cos(n\omega t + \psi_x^{(n)}) \quad (5.30)$$

$$\frac{F_z}{|\hat{F}_{e z}|} = F_z^{(0)} + \sum_{n \geq 1} F_z^{(n)} \cos(n\omega t + \psi_z^{(n)}) \quad (5.31)$$

Figure 5.11 shows the amplitudes of the zeroth (mean) and first harmonics of the horizontal and vertical non-dimensional forces as a function of kR , for incident waves of steepness ranging from $H/\lambda = 0.05\%$ to $H/\lambda = 1.00\%$. Figure 5.12 focuses on the second and third harmonics.

For both horizontal and vertical components, a convergence towards Evans predictions is obtained when decreasing the incident wave steepness. Even for the very low wave steepness, a slight discrepancy is still observed for longer waves. The top of the cylinder being very close to the free surface, nonlinear effects might be still be present. The gap might also be explained by a lack of resolution of the free surface. A global increase in wave steepness results in an increase of all harmonics, especially for longer waves where results also seem sensitive to wave height. The amplitude of the first harmonic is compared to Evans solution (5.13) with a good agreement, the observed gap with the linear solution remaining less than 5%, for all steepnesses.

The exciting forces obtained with the numerical model satisfy the formulation proposed by Evans [27], but reveal a significant influence of the incident wave steepness especially for longer waves. Especially, the influence of the wave steepness is clearly seen on the mean (zeroth order) vertical force, which is not exactly null compared to Evans results. In the following, a focus is made on the effect of incident wave steepness on the trajectory of the tuned cylinder, on the total hydrodynamic forces and on the efficiency of the Bristol cylinder device.

The tuned cylinder

The “tuning” angular frequency of the Bristol cylinder is chosen as $\omega_0 = 10$ rad/s ($kR = 0.51$), and the two linear generators in vertical and horizontal directions are consequently parametrized using the equations (5.24-5.25) with the computed hydrodynamic coefficients for this pulsation ω_0 (see Figs. 5.9 and 5.10). Periodic incident waves are generated by the Stream-Function method, with similar various wave steepnesses (see Tab. 5.1).

Total Hydrodynamic Forces The hydrodynamic forces acting on the moving cylinder are made non-dimensional and analyzed with the same harmonic decomposition as previously used for the exciting forces (Eqs. (5.30) and (5.31)). Figure 5.13 is a plot of the horizontal

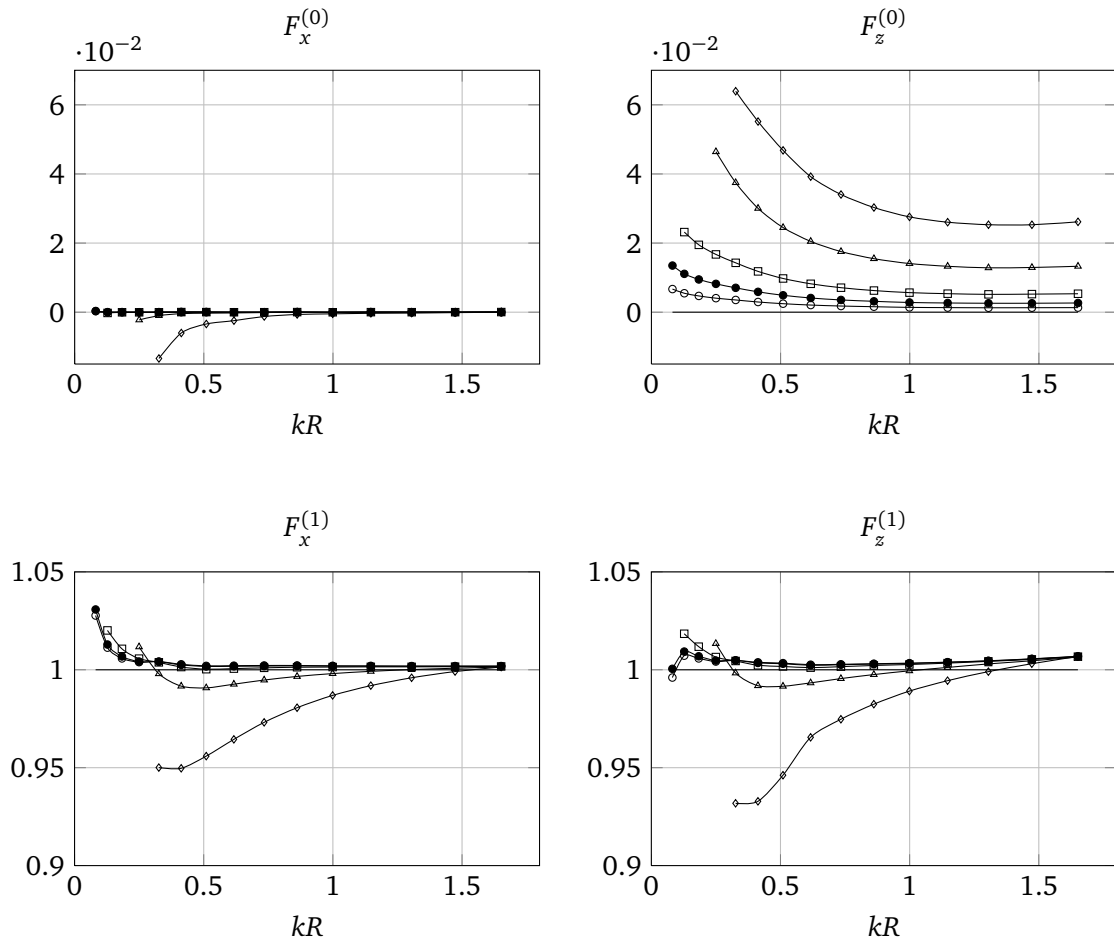

FIGURE 5.11 – Mean value and amplitude of the first harmonic of the horizontal (left) and vertical (right) non-dimensional exciting forces as a function of kR , for incident waves of various steepnesses : $H/\lambda = 0.05\%$ (\circ), 0.10% (\bullet), 0.20% (\square), 0.50% (\triangle), 1.00% (\diamond), compared to Evans linear prediction (—).

and vertical non-dimensional forces on the cylinder, for the tuning frequency $\omega = \omega_0 = 10$ rad/s ($kR = 0.51$).

Figure (5.14) shows the mean and first order horizontal and vertical forces as a function of kR , whereas Figure (5.15) shows the second and third order forces. The first harmonic is compared to Evans solution (5.20) with a relatively good agreement, except for shorter waves ($kR > 1$) where numerical results are larger than Evans prediction, independently of the wave steepness. This effect has not been observed for the exciting forces on the fixed cylinder and may be attributed to a nonlinear interaction of short waves with the moving cylinder. The linear theory, based on the assumption of small motions of the cylinder, assumes a simple superposition of exciting forces and radiation forces. This seems to underestimate the total hydrodynamic force for shorter waves ($kR > 1$) and to overestimate it for longer waves ($kR < 1$).

The effect of wave steepness is more clear on the other harmonics : the amplitude of the mean vertical force seems especially sensitive to the wave steepness, for all frequencies,

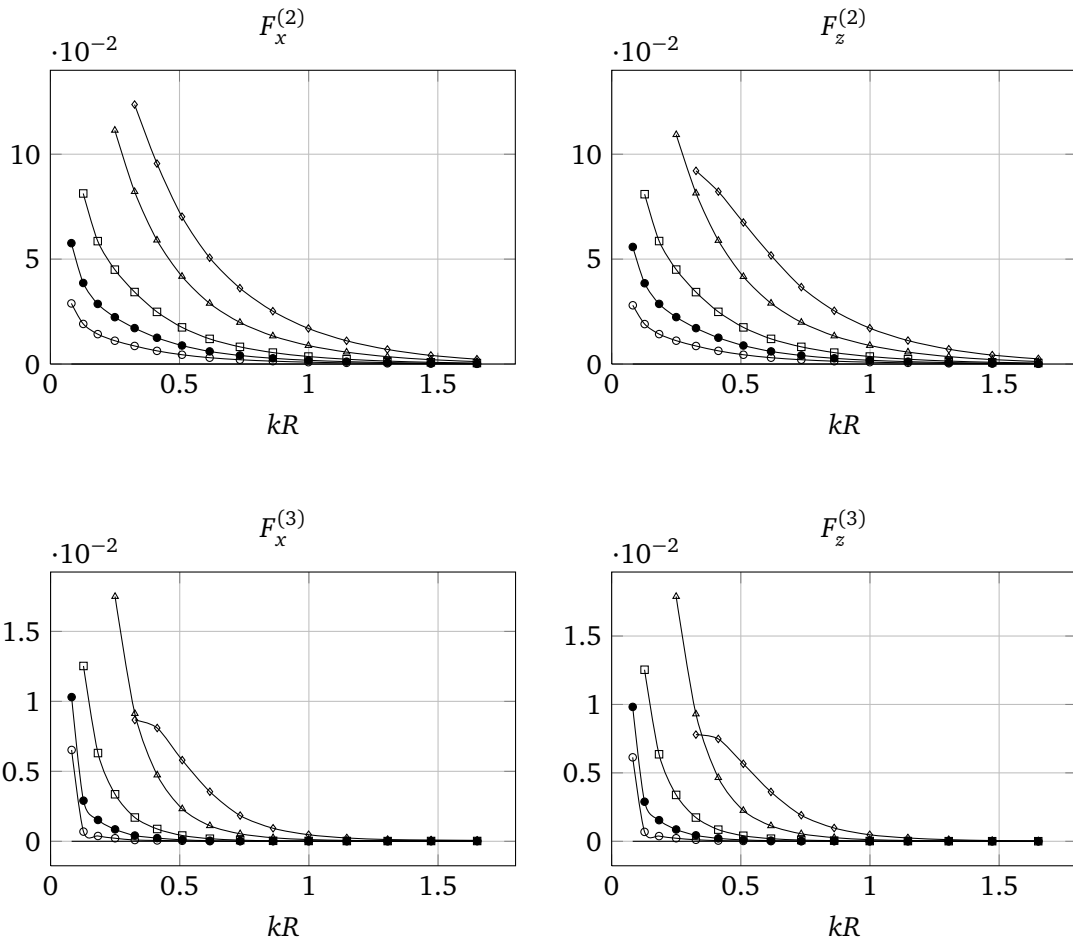

FIGURE 5.12 – Amplitudes of the second and third harmonics of the horizontal (left) and vertical (right) non-dimensional exciting forces as a function of kR , for incident waves of various steepnesses : $H/\lambda = 0.05\%$ (\circ), 0.10% (\bullet), 0.20% (\square), 0.50% (\triangle), 1.00% (\diamond), compared to Evans linear prediction (—).

whereas this is only the case for longer waves regarding the second- and third-order harmonics of the forces.

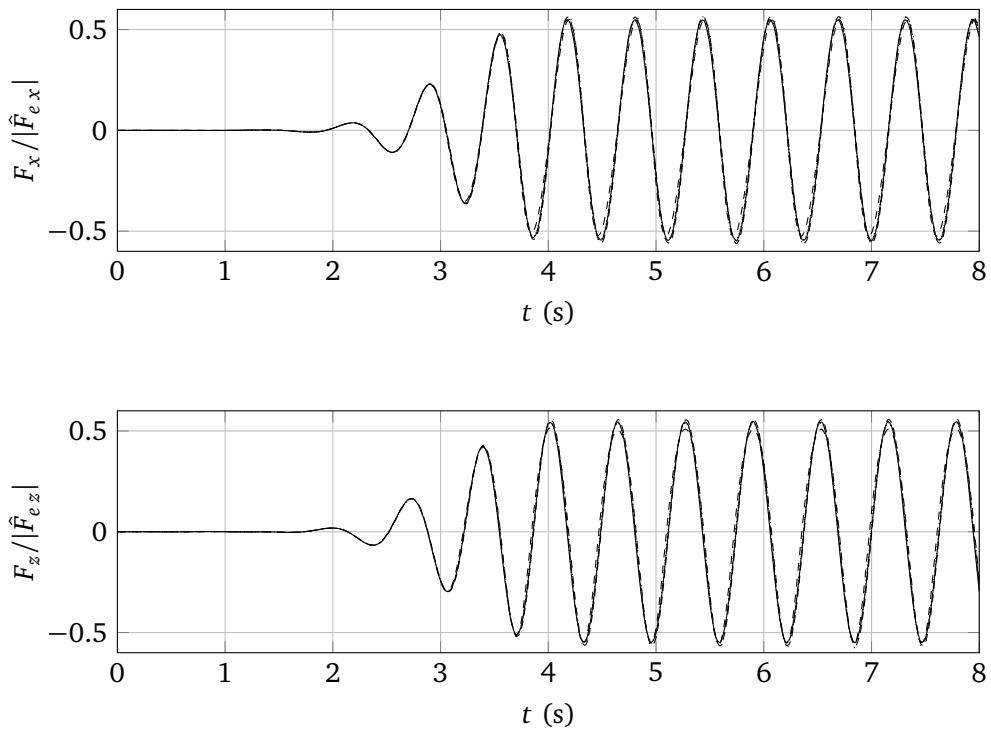

FIGURE 5.13 – Non-dimensional horizontal and vertical forces for $\omega = 10$ rad/s ($kR = 0.51$) and for incident waves of various steepnesses : $H/\lambda = 0.05\%$ (—), 0.10% (---), 0.20% (.....), 0.50% (·····), 1.00% (- - -).

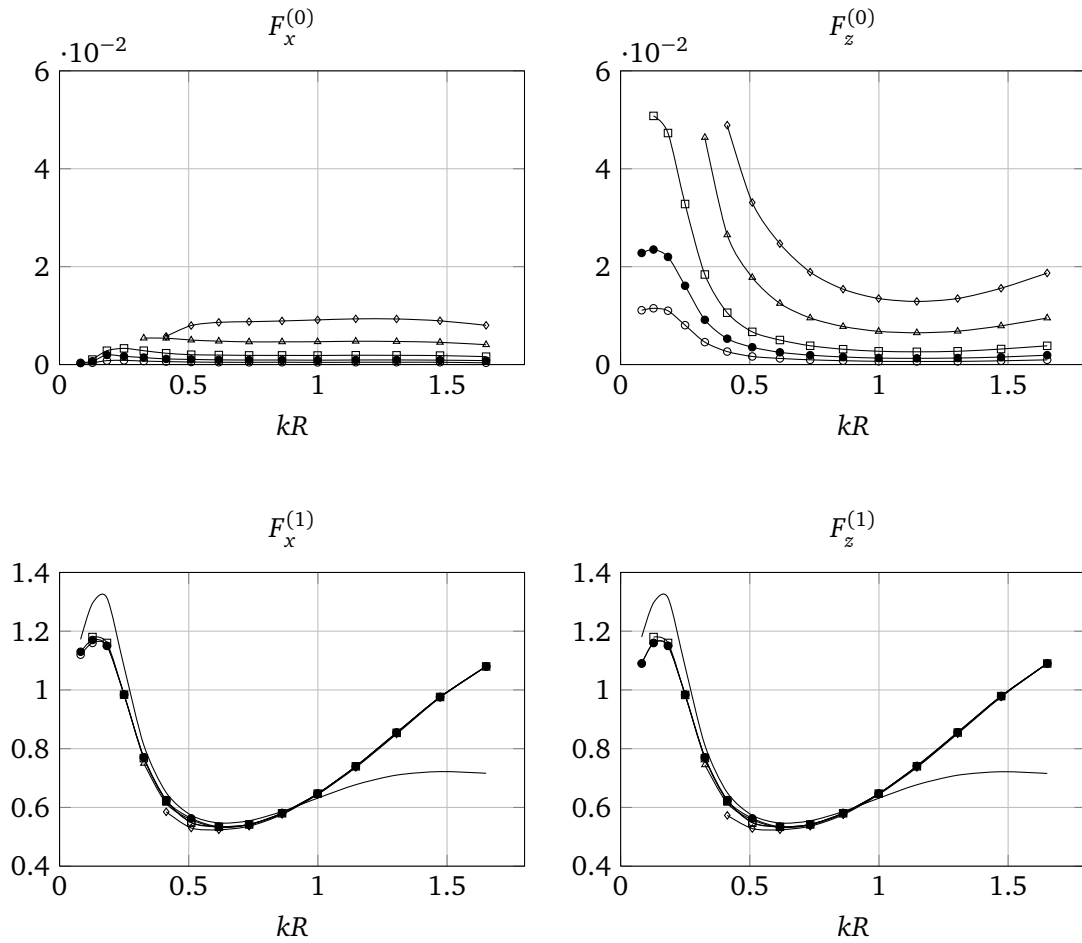

FIGURE 5.14 – Mean value and amplitude of the first harmonic of the horizontal (left) and vertical (right) non-dimensional total forces as a function of kR , for incident waves of various steepnesses : $H/\lambda = 0.05\%$ (\circ), 0.10% (\bullet), 0.20% (\square), 0.50% (\triangle), 1.00% (\diamond), compared to Evans linear prediction (—).

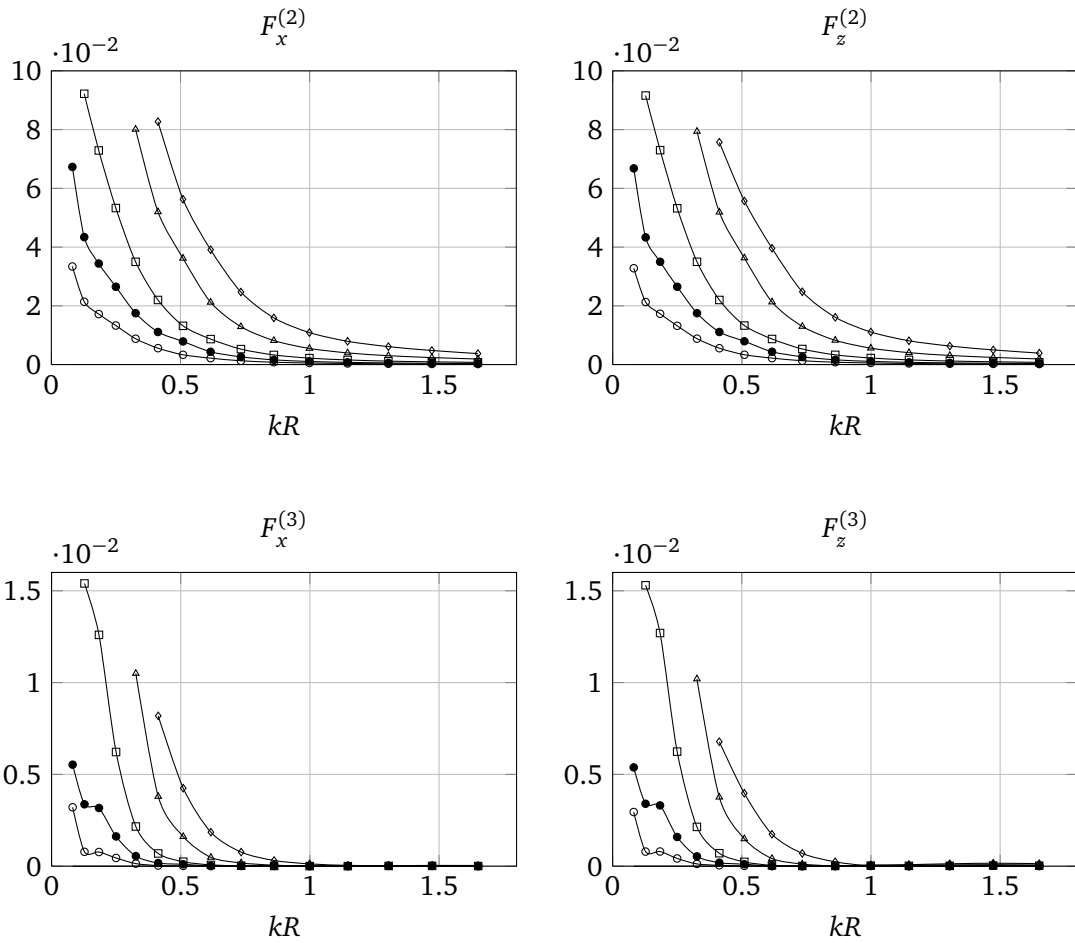

FIGURE 5.15 – Amplitudes of the second and third harmonics of the horizontal (left) and vertical (right) non-dimensional total forces as a function of kR , for incident waves of various steepnesses : $H/\lambda = 0.05\%$ (\circ), 0.10% (\bullet), 0.20% (\square), 0.50% (\triangle), 1.00% (\diamond), compared to Evans linear prediction (—).

Displacement of the cylinder center of mass Figure 5.16 is an example of the non-dimensional computed trajectories for $\omega = \omega_0 = 10$ rad/s ($kR = 0.51$), with comparison to the perfect circular path predicted by Evans in Eq. (5.21) centered on the origin. Two effects appear visually when increasing the incident wave steepness : there is a decrease of amplitude of the non-dimensional trajectory, as a consequence of the decrease of the first-order forces, and an upward displacement of the center of the trajectory, which is attributed to the increase of the mean vertical force on the cylinder shown on Fig. 5.14. A good agreement with Evans prediction is obtained for the lowest wave steepness, at the considered (tuning) frequency.

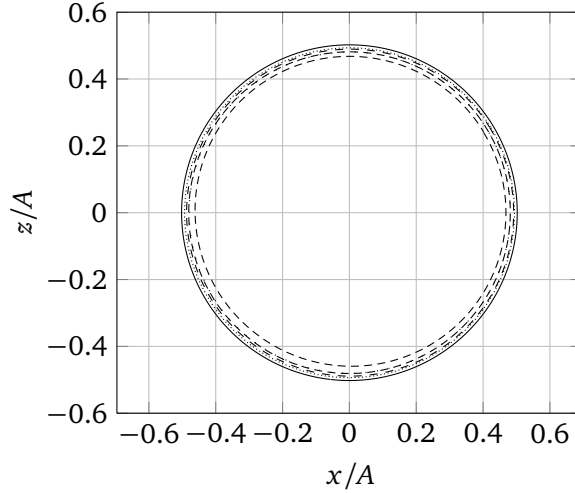

FIGURE 5.16 – Trajectory of the center of mass for $\omega = \omega_0 = 10$ rad/s ($kR = 0.51$), for incident waves of various steepnesses : $H/\lambda = 0.05\%$ (---), 0.10% (— · — ·), 0.20% (· · · ·), 0.50% (---), 1.00% (---), compared to Evans linear circular path (—).

Now for all frequencies, using the same procedure as for the forces, the non-dimensional displacement of the body center of mass $\mathbf{x} = (x, z)$ with reference to its static equilibrium position is analyzed based on the following Fourier decomposition,

$$\frac{\mathbf{x}}{A} = \mathbf{x}^{(0)} + \sum_{n \geq 1} \mathbf{x}^{(n)} \cos(n\omega t + \psi^{(n)}) \quad (5.32)$$

The FFT is applied on the four last periods of the horizontal and vertical displacements.

Figure 5.17 shows the mean and first-order horizontal (left) and vertical (right) displacements for each wave steepness, as a function of kR , and Figure 5.18 shows the second- and third-order displacements. There is a good symmetry of results in horizontal and vertical directions, except for the zeroth order displacements. As for the mean hydrodynamic forces, the mean vertical displacement is much more influenced by the wave steepness than the horizontal displacement. The first-order displacement is compared to Evans linear solution (5.21) with a good agreement, even though a difference is observed on the longest and shortest waves, as a result of the gap shown on the first order forces in Fig. 5.14. Similarly to the first-order forces, increasing wave steepness results in a slight decrease in first-order displacements.

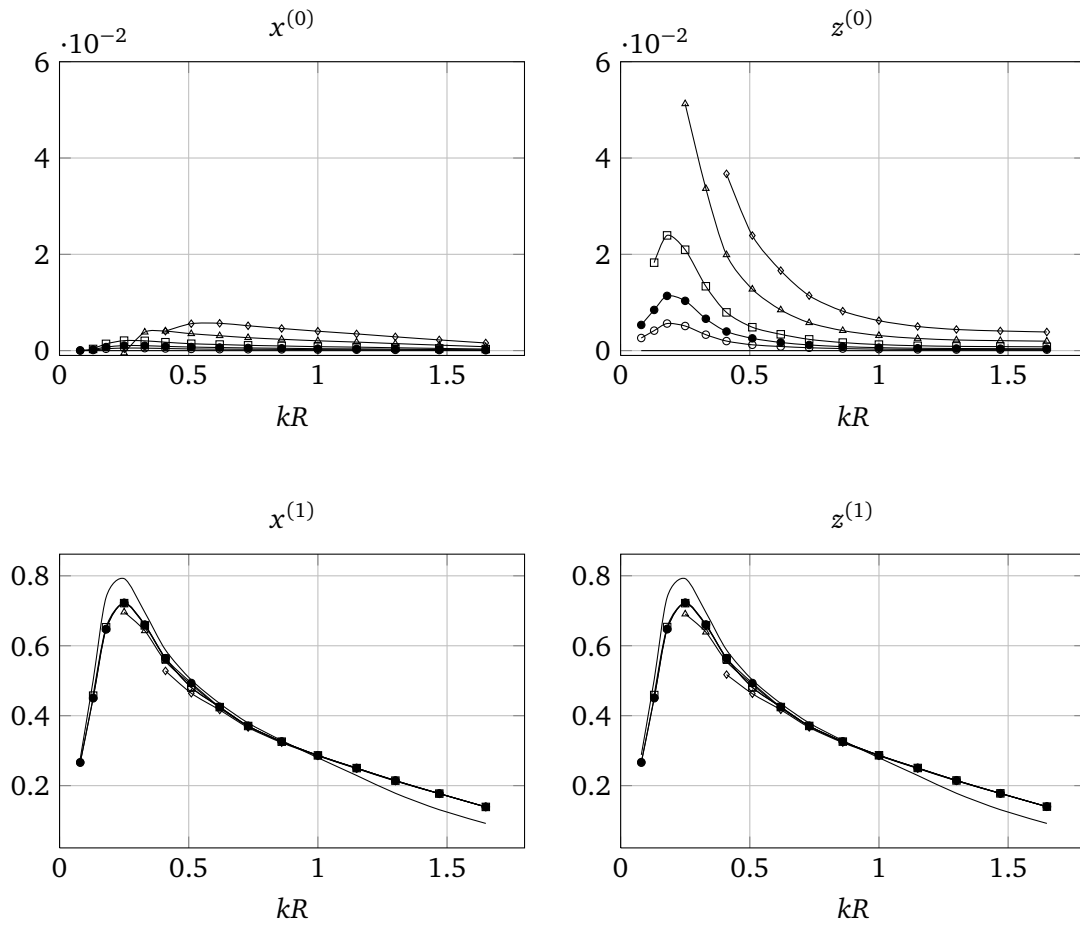

FIGURE 5.17 – Mean value and amplitude of the first order harmonic of the horizontal (left) and vertical (right) non-dimensional displacement of the center of mass as a function of kR , for incident waves of various steepnesses : $H/\lambda = 0.05\%$ (\circ), 0.10% (\bullet), 0.20% (\square), 0.50% (\triangle), 1.00% (\diamond), compared to Evans linear prediction (—).

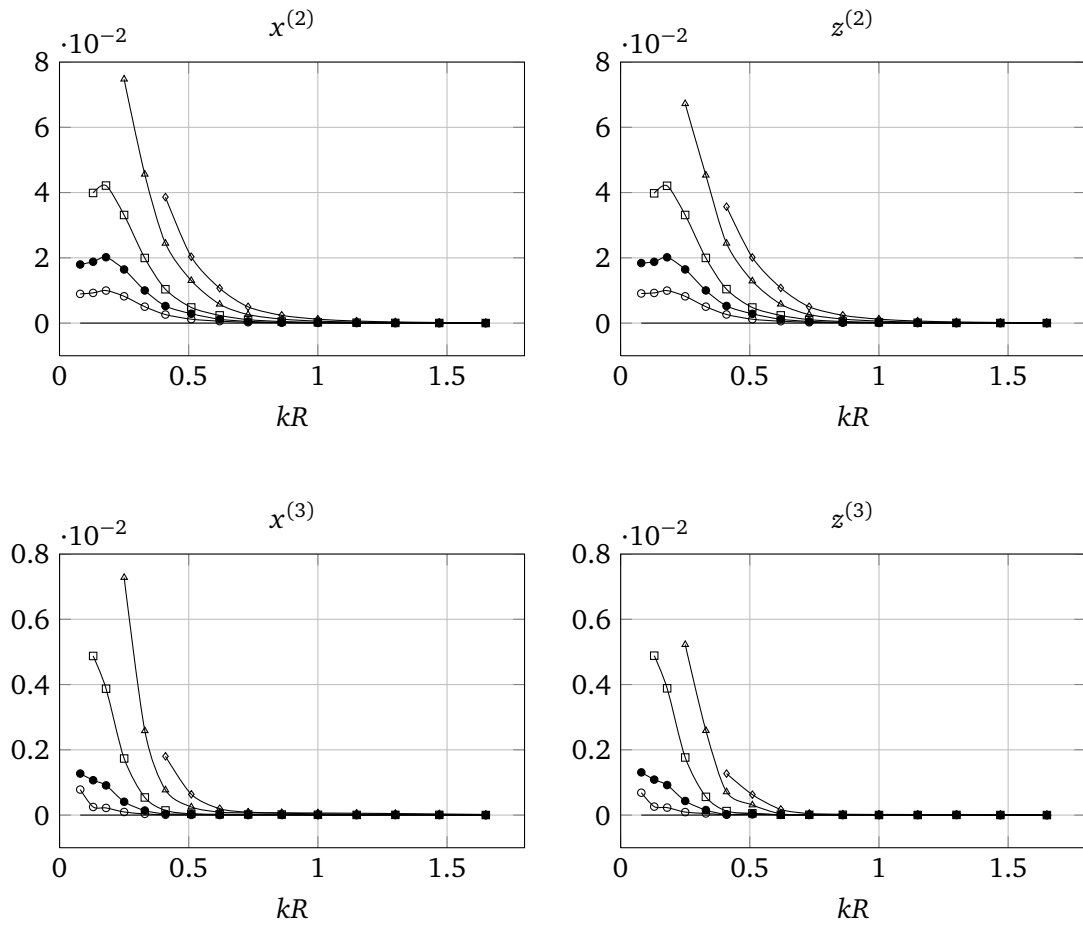

FIGURE 5.18 – Amplitudes of the second and third order harmonics of the horizontal (left) and vertical (right) non-dimensional displacement of the center of mass as a function of kR , for incident waves of various steepnesses : $H/\lambda = 0.05\%$ (\circ), 0.10% (\bullet), 0.20% (\square), 0.50% (\triangle), 1.00% (\diamond), compared to Evans linear prediction (—).

Efficacité du système en vagues régulières

La théorie linéaire développée par Evans et al. [28] permet un calcul analytique de l'efficacité E du cylindre de Bristol à partir de ses coefficients hydrodynamiques. Elle est définie comme le rapport de la puissance moyenne absorbée par le système $\langle \mathcal{P}_{abs} \rangle$ sur la puissance moyenne des vagues incidentes $1/4\rho\omega g^2 A^2$ (profondeur infinie) et vaut :

$$E(\omega) = \frac{4\omega^2 b_{ii}(\omega) D_0}{[K_0 - (M + a_{ii}(\omega))\omega^2]^2 + \omega^2 (D_0 + b_{ii}(\omega))^2} \quad (5.33)$$

On notera qu'à la fréquence de réglage, on obtient $E(\omega_0) = 1$, ce qui correspond à une absorption totale de l'énergie de la houle incidente. La figure 5.19 montre les résultats numériques obtenus à la fréquence de réglage ($\omega_0 = 10$ rad/s) sur l'élévation de surface libre adimensionnée par l'amplitude des vagues pour les cambrures considérées.

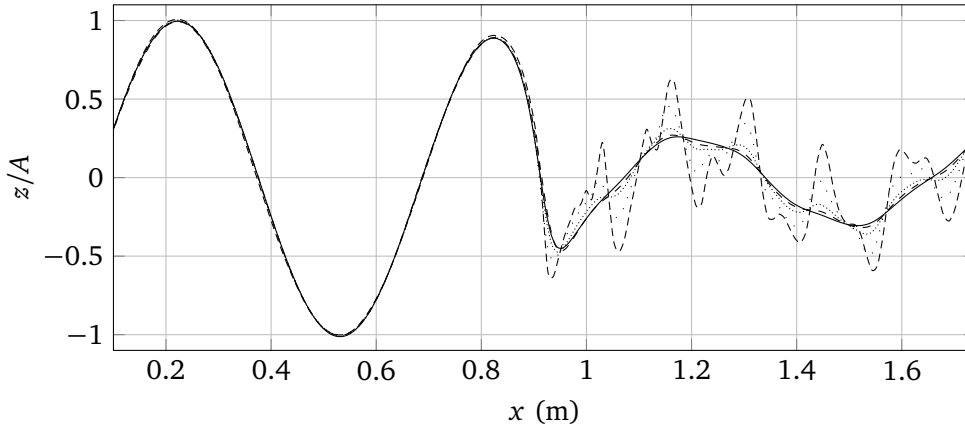

FIGURE 5.19 – Élévation de la surface libre adimensionnée, à $t = 8$ s, pour des vagues à la fréquence de réglage du système, et pour l'ensemble des cambrures considérées : $H/\lambda = 0.05\%$ (—), $H/\lambda = 0.10\%$ (- - -), $H/\lambda = 0.20\%$ (.....), $H/\lambda = 0.50\%$ (- · - ·), $H/\lambda = 1.00\%$ (- - - -). Le cylindre se trouve à l'abscisse $x = 0.92$ m (en moyenne).

Les vagues perdent en amplitude à l'aval du cylindre du fait de l'absorption d'énergie, mais cette absorption n'est pas totale. En particulier, on observe un accroissement des effets non-linéaires à l'aval du cylindre lorsque la cambrure des vagues incidentes augmente, avec une génération d'harmoniques d'ordres élevés. Ces effets sont accentués par le rapprochement important du cylindre près de la surface libre lorsque l'amplitude des vagues augmente. La figure 5.20 montre l'efficacité du système obtenue numériquement et comparée à la théorie linéaire d'Evans, pour l'ensemble des fréquences et cambrures considérées.

L'efficacité théorique d'Evans est proche de 1 sur une bande de fréquences allant de $kR = 0.40$ à $kR = 0.65$. Les résultats numériques convergent vers une efficacité maximale du système à environ 0.95 pour les faibles amplitudes de la houle, avec une bande spectrale plus large que celle obtenue par la théorie linéaire (Fig. 5.20), en raison de la sur-estimation des efforts hydrodynamiques constatée précédemment pour les faibles longueurs d'onde. Le système perd en efficacité lorsque la cambrure de la houle augmente, ce qui indique que le réglage (Eqs. 5.24-5.25) proposé par Evans ne reste pas optimal dans des conditions de vagues non-linéaires.

Evans a également réalisé des essais sur un cylindre de Bristol expérimental. Il utilise la

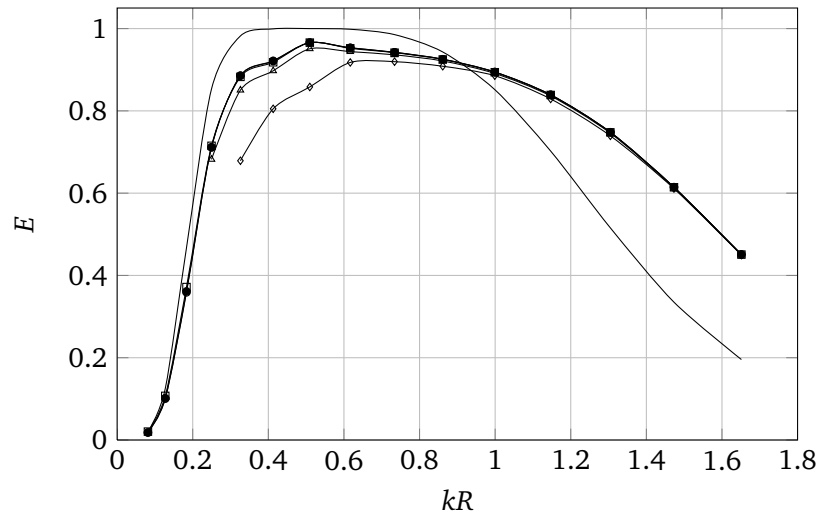

FIGURE 5.20 – Efficacité du cylindre de Bristol en fonction de kR pour les cambrures $H/\lambda = 0.05\%$ (\circ), $H/\lambda = 0.10\%$ (\bullet), $H/\lambda = 0.20\%$ (\square), $H/\lambda = 0.50\%$ (\blacktriangle), $H/\lambda = 1.00\%$ (\diamond). La théorie linéaire d’Evans correspond à la courbe en trait plein.

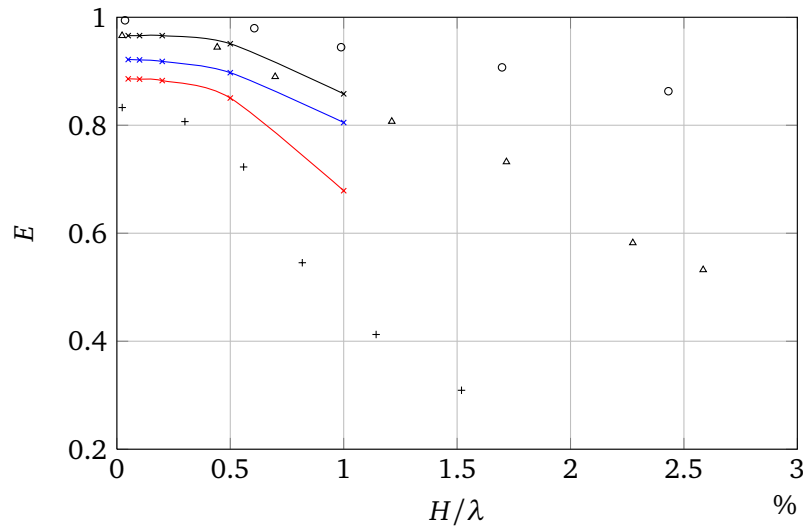

FIGURE 5.21 – Efficacité du cylindre de Bristol en fonction de la cambrure des vagues incidentes, mesurée expérimentalement par Evans [28] (pour un cylindre réglé à $kR = 0.55$), pour 3 fréquences : $kR = 0.55$ (\circ), $kR = 0.40$ (\triangle) et $kR = 0.27$ ($+$). Nos résultats de simulations pour le même cylindre mais réglé à $kR = 0.51$ sont également représentés aux fréquences $kR = 0.51$ (\bullet), $kR = 0.41$ (\blacktriangle) et $kR = 0.33$ (\blacklozenge).

même configuration que celle représentée à la figure 5.8, mais la profondeur du canal est fixée à 60 cm. Grâce à un système qui permet de modifier progressivement les paramètres de raideur et d’amortissement des ancrages, Evans a pu calibrer son cylindre à la fréquence $kR = 0.55$. La figure 5.21 présente l’efficacité mesurée par Evans en augmentant progressivement la hauteur des vagues incidentes (les mesures ont été obtenues en scannant la figure publiée par Evans dans [28]). A titre comparatif, nous avons représenté nos résultats obtenus sur un

cylindre configuré de manière légèrement différente, mais la décroissance de l'efficacité du système en fonction de la cambrure des vagues est très similaire dans les deux cas. Il semble que l'efficacité diminue plus vite pour les plus grandes longueurs d'onde (pente plus forte en valeur absolue). C'est un résultat également visible sur la figure 5.20. A noter que le triangle le plus à droite obtenu par Evans pour $kR = 0.40$ correspond à une amplitude de vagues incidentes d'environ 1 cm alors que le sommet du cylindre est initialement immergé à 1.25 cm sous la surface libre. Il paraît donc peu probable que le cylindre soit resté totalement immergé au cours de son mouvement et qu'aucun déferlement n'ait été observé durant les essais.

Conclusion partielle

Un système houlomoteur schématique, appelé "Cylindre de Bristol", a été étudié théoriquement et analytiquement à la fin des années 1970 par Evans et son équipe [27, 28] à l'aide de la théorie linéaire pour des vagues périodiques en profondeur infinie. En raison de l'égalité des coefficients hydrodynamiques du cylindre dans les directions horizontales et verticales, il est possible d'absorber, en théorie, la totalité de l'énergie de la houle incidente à une fréquence donnée en procédant à un réglage optimal des coefficients de raideur et d'amortissement des deux générateurs. Dans ces conditions et pour chaque fréquence de houle, le cylindre décrit théoriquement une trajectoire circulaire dont l'amplitude varie en fonction de l'amplitude des vagues et de leur fréquence. Une configuration particulière d'un cylindre de rayon 5 cm dont le centre est immergé à 6.25 cm sous la surface libre au repos a été simulée à l'aide du modèle non-linéaire. Les coefficients hydrodynamiques du cylindre ont été calculés et comparés favorablement aux résultats numériques de Frank [31] obtenus à l'aide d'un modèle linéaire et aux résultats obtenus à partir de la solution analytique décrite par Evans et Porter [29]. Les efforts sur le cylindre fixe ont également été comparés aux formulations analytiques d'Has-kind et Newman [46, 63] pour un ensemble de vagues périodiques de cambrures variant de 0.05 % à 1.00 %, avec un bon accord pour les faibles cambrures. Une analyse harmonique des efforts a fait apparaître un accroissement significatif de la dérive verticale avec la cambrure des vagues, non pris en compte dans la théorie d'Evans. Dans un second temps, le cylindre libre et réglé à la pulsation $\omega_0 = 10$ rad/s, a été soumis à ces mêmes vagues. Une analyse harmonique des efforts hydrodynamiques et de la position du centre du cylindre a également révélé une forte sensibilité de la force de dérive verticale à la cambrure des vagues et une légère diminution des efforts horizontaux et verticaux de premier ordre avec la cambrure. Ces deux résultats se traduisent par un déplacement vers le haut du centre de la trajectoire du cylindre et une faible diminution de son amplitude pour les fortes cambrures. L'efficacité théorique de 100% à la fréquence de réglage n'a pas été obtenue par le modèle numérique, avec une efficacité maximale de 95 % uniquement. L'augmentation de la hauteur des vagues à la fréquence de réglage accroît notamment les effets non-linéaires en aval du cylindre du fait d'un fort rapprochement du sommet du cylindre avec la surface libre. Les interactions entre le cylindre et la surface libre se traduisent par une génération d'harmoniques d'ordres élevés en aval du cylindre. Le déferlement de certaines vagues les plus cambrées a été observé au sommet du cylindre au cours des simulations numériques.

5.4 Comparaison à des essais en canal à houle

Dans les chapitres précédents, nous avons confronté les résultats du modèle numérique à des résultats issus de théories analytiques linéaires avec un bon accord, dans la limite des hypothèses de la théorie linéaire (vagues de faible amplitude, faible mouvement de la structure devant ses propres dimensions, grande longueur d'onde devant les dimensions de la structure). La littérature offre peu de résultats expérimentaux sur des systèmes houlomoteurs bi-dimensionnels immergés : Evans a effectué des essais sur le cylindre de Bristol [28] en vagues périodiques pour valider ses résultats analytiques obtenus à l'aide la théorie linéaire sur l'efficacité du système. Il constate expérimentalement une diminution de l'efficacité lorsque l'amplitude des vagues augmente, un résultat également obtenu avec le modèle numérique. Ces travaux ne mentionnent malheureusement que les mesures d'efficacité du système et les résultats sur l'amplitude du mouvement du cylindre n'ont pas été publiés.

Yim et al. [84, 83] ont quant à eux confronté leur modèle numérique 2D fondé sur la théorie potentielle non-linéaire à des résultats expérimentaux obtenus en canal sur le cas d'une sphère immergée mobile uniquement dans les directions horizontale et verticale. Ils transforment la sphère en un cylindre circulaire horizontal équivalent pour représenter le problème en deux dimensions horizontale et verticale. En conclusion, ils recommandent d'utiliser un modèle 3D pour simuler la dynamique d'une sphère, plus approprié à représenter l'écoulement autour d'une structure tri-dimensionnelle.

Pour tenter de valider le modèle numérique en comparaison à des résultats d'essais, nous avons construit un système houlomoteur expérimental bi-dimensionnel, semblable au concept du cylindre de Bristol mais relié à un unique générateur linéaire. La contrainte étant de s'assurer que le système possède une dynamique proprement bi-dimensionnelle. Ces essais ont été menés à l'Université du Rhode Island (USA), en collaboration avec le Pr. Stephan Grilli, un groupe de quatre étudiants en Master et l'équipe des techniciens du laboratoire que je remercie au passage. Ces essais ont été réalisés sur une période relativement courte : après un séjour de 3 semaines pour la préparation du système en Novembre 2010, les essais ont été poursuivis jusqu'à mi-décembre.

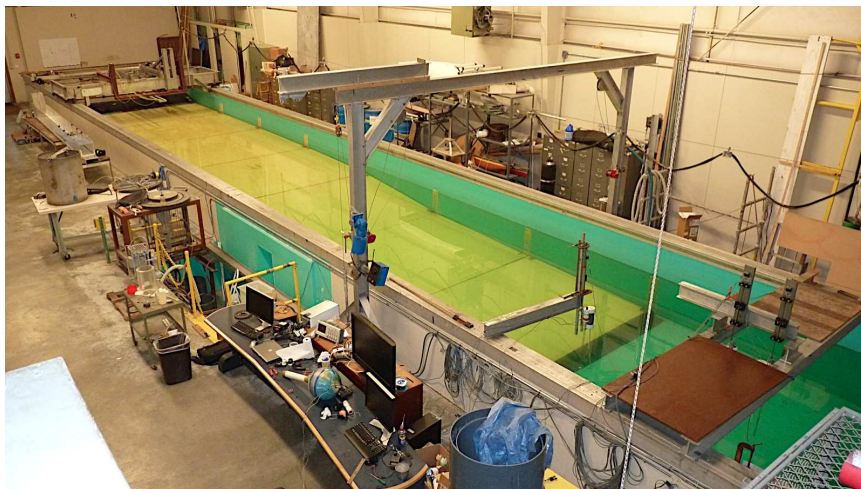

FIGURE 5.22 – Canal à houle de l'Université du Rhode Island. Le batteur est situé côté droit de la photographie.

5.4.1 Présentation des essais

Le système houlomoteur a été construit à l'Université du Rhode Island par l'équipe des techniciens de l'Ocean Engineering Department. Il a ensuite été installé dans le canal à houle de l'Université et testé dans des conditions de vagues régulières et irrégulières. Deux accéléromètres disposés sur le système ont permis de mesurer l'amplitude de son mouvement et les données ont ensuite été comparées aux résultats numériques, uniquement dans le cas de vagues périodiques. Faute de temps, les mesures faites en vagues irrégulières n'ont pu être exploitées à ce jour.

Le canal à houle de l'Université du Rhode Island

Le canal utilisé pour les essais a pour dimensions 3.66 m de largeur sur environ 30 m de longueur, avec un fond de profondeur $h = 1.31$ m constante sur les 9.50 premiers mètres (voir Figs. 5.22 et 5.23). Un faux fond en pente douce, constitué de 7 panneaux plans, est disposé à la fin du canal de façon à provoquer le déferlement des vagues et limiter la réflexion dans le canal. Le batteur utilisé pour la génération est un batteur plan de type volet qui permet de générer des houles régulières de périodes allant de 0.5 à 2 s environ. Il peut également générer des houles irrégulières à partir d'un spectre de JONSWAP donné. La figure 5.23 montre le profil bathymétrique mesuré du canal, ainsi que le profil utilisé dans les tests numériques pour lequel une plage absorbante de profondeur 0.50 m est ajoutée pour une meilleure absorption. Dans chaque simulation, la longueur de la plage absorbante est adaptée pour couvrir environ quatre fois la longueur d'onde des vagues générées.

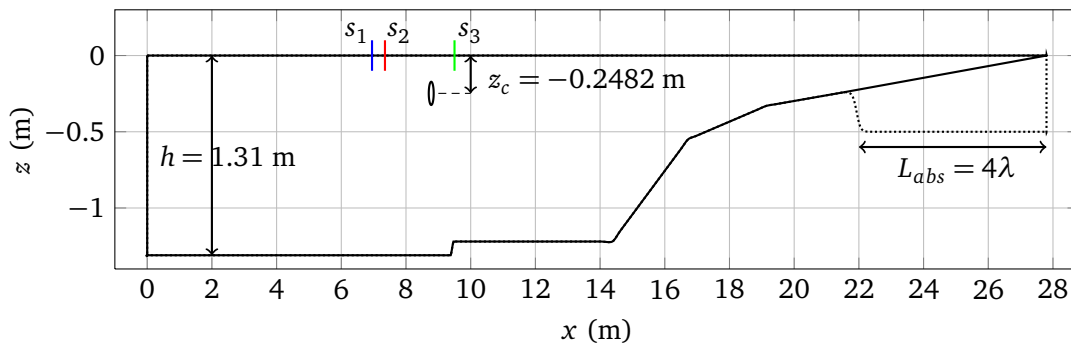

FIGURE 5.23 – Profil bathymétrique du canal mesuré (—) et profil utilisé dans les simulations numériques (.....). Trois sondes s_1 , s_2 et s_3 sont placées dans le canal pour mesurer le profil de surface libre en amont et en aval du système.

Durant les essais, le profil de surface libre est enregistré par trois sondes disposées de part et d'autre du système, situées respectivement à 1.85 m et 1.45 m en amont et 0.70 m en aval du cylindre.

Montage expérimental

Le système étudié est constitué d'un cylindre circulaire horizontal en acier, creux, de masse totale $M = 54.9$ kg, de rayon extérieur $R = 7.62$ cm et de longueur $L = 3.62$ m. Il occupe donc quasiment toute la largeur du canal, puisqu'un écart de seulement 2 cm est laissé entre les murs du canal et chaque extrémité du cylindre. Le cylindre est relié en son centre à un

générateur linéaire lui-même stabilisé au fond du bassin par un ensemble de masses posées sur un plateau circulaire. Le générateur est composé d'une bobine fixe et d'un aimant, dont les mouvements relatifs créent un courant électrique par induction magnétique, qui est acheminé vers la table de contrôle via un système de guidage étanche. Au cours du mouvement, le générateur exerce sur le cylindre un effort de rappel élastique de raideur $K_0 = 1107.9 \text{ N/m}$ et un effort d'amortissement de coefficient $D_0 = 5.584 \text{ N/m/s}$, dirigés dans l'axe du générateur. Ces valeurs ont été mesurées lors d'expériences précédentes et reprises telles quelles ici. Deux ressorts verticaux identiques de raideurs $K = 35 \text{ N/m}$, valeurs mesurées par les étudiants, sont ajoutés de chaque côté du cylindre pour s'assurer que le cylindre ne soit pas déséquilibré d'un côté ou de l'autre au cours de son mouvement.

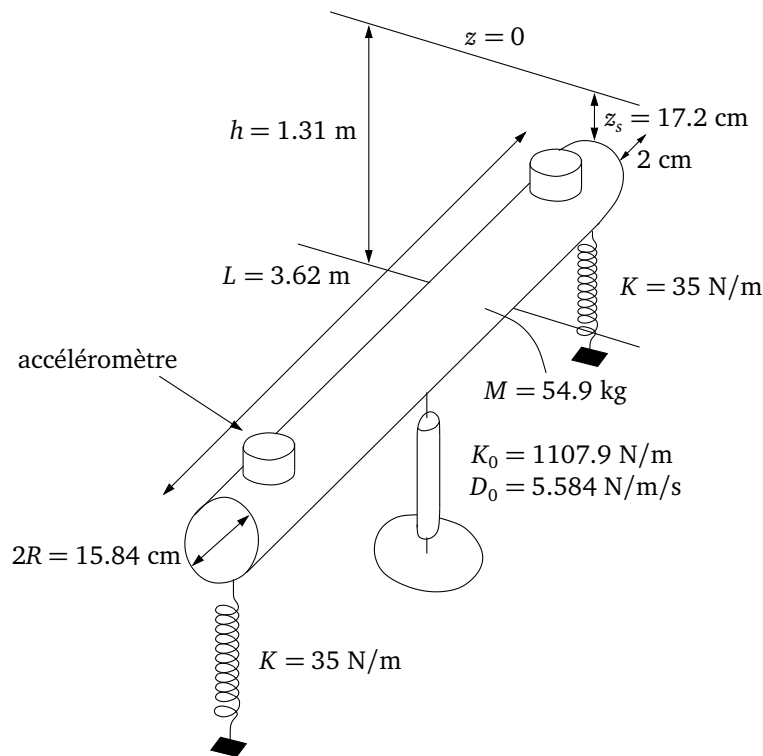

FIGURE 5.24 – Caractéristiques et dimensions du système houlomoteur.

En supposant les vagues et les efforts induits parfaitement bi-dimensionnels, ce système possède en théorie deux degrés de liberté. En pratique, les effets de bords, la non-homogénéité des vagues sur la largeur du canal ou les imperfections du cylindre peuvent induire des mouvements transverses de la structure, c'est pourquoi des bouchons de plastique ont été ajoutés à chaque extrémité pour absorber les chocs éventuels sur les parois du canal. Des lignes d'ancrage lâche relient chaque extrémité du cylindre au bord du canal de façon à empêcher une éventuelle rotation du cylindre autour de l'axe vertical (mouvement de lacet) sans perturber les mouvements horizontaux et verticaux. En pratique, ni choc sur les parois ni mouvement de lacet n'ont été observé visuellement durant les essais. De chaque côté du cylindre sont disposées des boîtes étanches contenant chacune un accéléromètre qui enregistre les accélérations radiales et tangentielles à chaque extrémité du cylindre. La comparaison des enregistrements issus de ces deux accéléromètres doit permettre de vérifier le caractère bi-dimensionnel du mouvement du cylindre.



FIGURE 5.25 – Le système mis à l'eau avant les essais. On distingue au centre du cylindre le générateur et le système de guidage des fils électriques, et de chaque côté les deux ressorts latéraux surmontés des boîtiers contenant les accéléromètres.

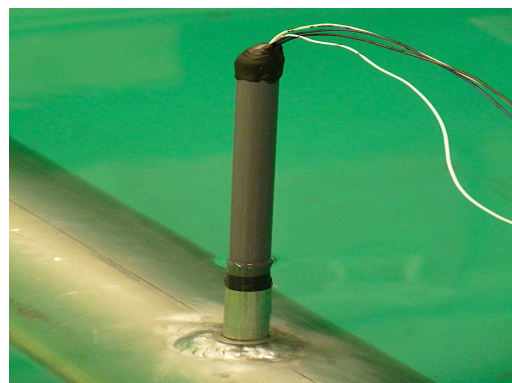
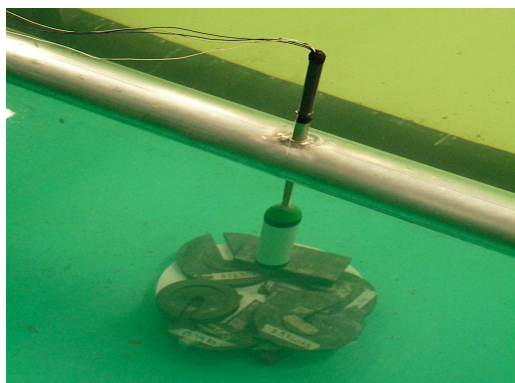

FIGURE 5.26 – A gauche : le générateur linéaire ancré par une plateforme circulaire au fond du bassin. A droite : le système de guidage étanche des fils électriques.

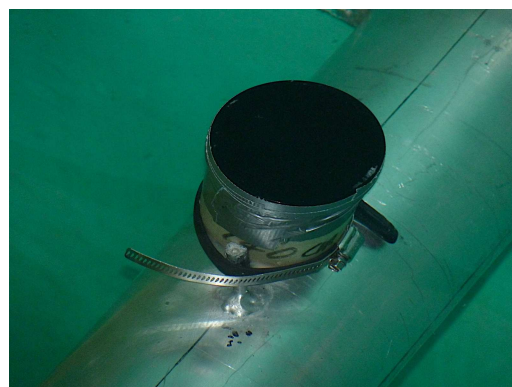

FIGURE 5.27 – A gauche : une extrémité du cylindre au repos, située à quelques centimètres de la paroi du canal. On distingue les lignes d'ancrage. A droite : un des deux boîtiers étanches contenant un accéléromètre.

5.4.2 Modélisation du système

Ce système est modélisé à l'aide du modèle non-linéaire 2DV-NWT par un cylindre horizontal circulaire de masse $M = 15.17 \text{ kg/m}$. Le sommet du cylindre est initialement immergé à $z_s = -17.2 \text{ cm}$ sous la surface libre au repos (le centre est à la côte $z_c = -24.82 \text{ cm}$).

Bilan des efforts

Sous l'effet des vagues, le générateur peut s'incliner autour de son point d'ancrage fixe, si bien que le cylindre possède deux degrés de liberté : un degré de rotation autour du point d'ancrage noté θ et un degré de translation dans la direction radiale noté r , comme illustré sur la figure 5.28.

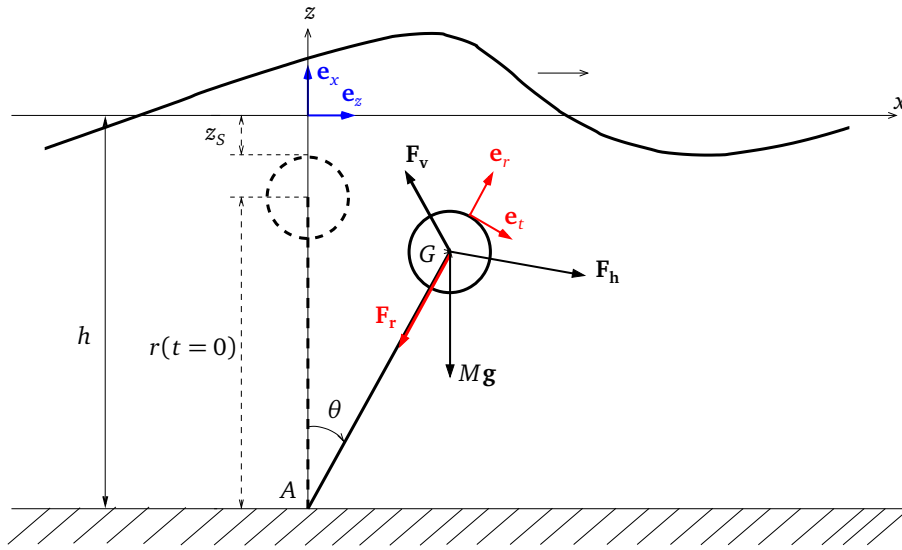

FIGURE 5.28 – Bilan des efforts exercés sur le cylindre : le poids Mg , les efforts de pression hydrodynamique F_h , les efforts F_r dans la direction radiale et la traînée visqueuse F_v .

Le corps est naturellement soumis à son poids Mg et aux efforts de pression hydrodynamique totale F_h qui incluent la poussée d'Archimède. Le cylindre subit également un effort de rappel élastique de la part du générateur et des ressorts latéraux de raideur totale $K_0 = 325.4 \text{ N/m}^2$. L'extraction d'énergie par le générateur est modélisée par un effort d'amortissement linéaire $D_0 = 1.54 \text{ N/m}^2/\text{s}$ proportionnel à la vitesse radiale \dot{r} du cylindre dans l'axe du générateur. La somme F_r des efforts dans la direction radiale s'exprime donc sous la forme :

$$F_r = -k_0(r - r_0)e_r - D_0\dot{r}e_r \quad (5.34)$$

où (e_r, e_t) désigne la base locale des coordonnées polaires associées au centre de gravité G du cylindre (voir Fig.5.28). r_0 est l'extension radiale du système, calculée lorsque le cylindre est à l'équilibre à l'état initial. On ajoute à cette description un effort de traînée visqueuse noté F_v qui prend en compte la viscosité de l'eau dans la dynamique du cylindre et qui est explicité dans la suite. Le principe fondamental de la dynamique du cylindre appliqué à son centre de gravité s'écrit finalement :

$$M\ddot{\mathbf{x}} = Mg + F_h + F_r + F_v \quad (5.35)$$

A $t = 0$ lorsque le cylindre est immobile, l'équilibre des efforts de pression (qui correspondent à la poussée d'Archimède), du poids et du rappel élastique permet de calculer l'extension radiale à vide r_0 par la relation suivante :

$$r_0 = r(t = 0) + \frac{(M - \rho \pi R^2)g}{K_0 + 2K} \quad (5.36)$$

5.4.3 Prise en compte des effets visqueux dans la dynamique du système

De façon à se rapprocher du comportement du cylindre dans un fluide réel, on introduit la traînée visqueuse F_v , définie par la formulation classique de Morison :

$$\mathbf{F}_v = -\frac{1}{2}\rho AC_d \|\dot{\mathbf{x}} - \nabla\phi_f(\mathbf{x})\| (\dot{\mathbf{x}} - \nabla\phi_f(\mathbf{x})) \quad (5.37)$$

où ρ est la masse volumique du fluide, A la surface du corps frontale à l'écoulement ou maître-couple ($A = 2R$ dans le cas d'un cylindre circulaire de rayon R), C_d est le coefficient de traînée, $\dot{\mathbf{x}}$ la vitesse du corps et $\nabla\phi_f(\mathbf{x})$ la vitesse du fluide à la position du centre de gravité et en l'absence du corps.

Approximations de la vitesse du fluide et de la vitesse relative

La formulation de Morison (5.37) nécessite de connaître à chaque instant la vitesse du fluide à la position instantée du corps, en l'absence du corps. En effectuant une simulation numérique du canal à houle sans cylindre, il est possible de mesurer à chaque instant les vitesses du fluide sur un domaine situé autour de la position initiale du cylindre. En simulant ensuite le canal à houle avec le cylindre, par interpolation spatio-temporelle des vitesses préalablement mesurées, on peut accéder à une bonne évaluation du terme $\nabla\phi_f(\mathbf{x})$. Une méthode plus simple, adoptée par la suite, consiste à assimiler la vitesse du fluide $\nabla\phi_f(\mathbf{x})$ à la position instantée du corps par la vitesse du fluide à la position initiale du corps \mathbf{x}_0 :

$$\nabla\phi_f(\mathbf{x}) \approx \nabla\phi_f(\mathbf{x}_0)$$

La vitesse du fluide $\nabla\phi_f(\mathbf{x}_0)$ est calculée à l'aide d'une simulation en l'absence de corps et remplace le terme $\nabla\phi_f(\mathbf{x})$ dans (5.37).

La formulation des efforts de traînée (5.37) pour un mouvement bi-dimensionnel non restreint à un unique degré de liberté implique un couplage des deux composantes de l'accélération du corps via la norme de la vitesse relative $\|\dot{\mathbf{x}} - \nabla\phi_f\|$. De façon à découpler les deux composantes, une seconde approximation est effectuée pour alléger la résolution numérique : on fait l'approximation de continuité de la vitesse relative entre deux instants successifs t_n et t_{n-1} :

$$\|\dot{\mathbf{x}} - \nabla\phi_f\|_n \approx \|\dot{\mathbf{x}} - \nabla\phi_f\|_{n-1}$$

Finalement, à chaque itération t_n , la force de traînée visqueuse se ramène à une force linéaire en la vitesse du corps sous la forme :

$$\mathbf{F}_v(t_n) = -d_{n-1} (\dot{\mathbf{x}}_n - \nabla\phi_{f,n}) \quad (5.38)$$

avec le terme d'amortissement que l'on peut calculer explicitement sous la forme $d_{n-1} = \frac{1}{2}\rho AC_d \|\dot{\mathbf{x}} - \nabla\phi_f\|_{n-1}$.

Régime de l'écoulement et choix du coefficient de traînée C_d

De nombreux travaux se sont intéressés au calcul du coefficient de traînée d'un cylindre circulaire fixe dans un écoulement uniforme ou oscillant, pour des applications de dimensionnement de structures offshore de type pipeline. Les travaux de Sarpkaya [66] et Sumer et Fredsøe [71] font référence en la matière. Ils obtiennent des résultats qui ne sont valables que pour des cylindres fixes ou des cylindres mobiles dont la vitesse est négligeable devant celle de l'écoulement ambiant. Bien que notre cylindre soit mobile, on rappelle ici leurs principaux résultats afin de caractériser le régime de l'écoulement autour du système pour en déduire une valeur réaliste du coefficient de traînée, bien que dans les conditions des essais, le cylindre se déplace à une vitesse a priori non-négligeable devant celle de l'écoulement. Dans le cas d'un cylindre circulaire immergé dans un courant constant et uniforme, l'hydrodynamique est gouvernée par le nombre de Reynolds Re :

$$Re = \frac{2U_m R}{\nu} \quad (5.39)$$

où R est le rayon du cylindre, ν la viscosité cinématique de l'eau (prise ici égale à 10^{-6} m²/s). Lorsque le cylindre est soumis à un écoulement oscillant provoqué par une houle incidente de période T , un paramètre supplémentaire, le nombre de Keulegan-Carpenter, est nécessaire pour caractériser le régime de l'écoulement :

$$Kc = \frac{U_m T}{2R} \quad (5.40)$$

Un faible Kc signifie que le mouvement orbital des particules d'eau est petit devant la dimension du cylindre et pour de très faibles valeurs de Kc , il n'y a pas de séparation de l'écoulement à l'aval du cylindre. Pour de fortes valeurs de Kc , les particules d'eau parcourent une grande distance devant la dimension du cylindre, ce qui peut provoquer une séparation de l'écoulement et la génération de vortex de part et d'autre du cylindre.

On cherche maintenant à caractériser l'écoulement via Re et Kc dans les conditions des essais et des simulations numériques, c'est-à-dire pour des vagues régulières de périodes allant de $T = 1.0$ s à $T = 2.4$ s et une hauteur de vague $H = 4$ cm. Dans un premier temps, la houle est générée et propagée dans le canal en l'absence du cylindre de façon à mesurer la vitesse de l'écoulement à la position qu'occuperait le cylindre à l'état initial (terme $\nabla\phi_f(\mathbf{x}_0)$ dans (5.37)). On note respectivement U_m et W_m les vitesses maximales de l'écoulement dans les directions horizontale et verticale, obtenues numériquement. Le tableau 5.2 résume pour chaque simulation les paramètres de vagues (période, hauteur, longueur d'onde, cambrure) et de l'écoulement (vitesses maximales, nombre de Reynolds et nombre de Keulegan-Carpenter). La dernière colonne du tableau présente aussi la valeur du coefficient de traînée prédite par la formulation de Sarpkaya [66] valable à bas Kc ,

$$C_d = \frac{3\pi^3}{2Kc} \left(\frac{1}{\sqrt{\pi\beta}} + O\left(\frac{1}{\beta}\right) \right) \quad (5.41)$$

T (s)	H (m)	λ (m)	H/λ	U_m (m/s)	W_m (m/s)	Re	Kc	C_d
1.0	0.04	1.56	2.56%	0.046	0.045	6976	0.30	0.57
1.2	0.04	2.25	1.78%	0.052	0.051	7969	0.41	0.46
1.4	0.04	3.03	1.32%	0.055	0.052	8308	0.50	0.41
1.6	0.04	3.88	1.03%	0.054	0.051	8250	0.57	0.38
1.8	0.04	4.75	0.84%	0.055	0.048	8318	0.64	0.36
2.0	0.04	5.61	0.71%	0.054	0.045	8241	0.71	0.34
2.2	0.04	6.46	0.62%	0.055	0.042	8410	0.80	0.32
2.4	0.04	7.29	0.55%	0.052	0.041	7908	0.82	0.33

TABLE 5.2 – Pour chaque période T , longueur d’onde λ , cambrure H/λ , vitesses orbitales horizontale et verticale maximales sous les vagues U_m et W_m , nombre de Reynolds Re , nombre de Keulegan-Carpenter Kc associés et coefficient de traînée prédit par la relation de Sarpkaya 5.41. La profondeur du canal est de $h = 1.31$ m.

La figure 5.29 présente les différents régimes d'écoulement autour d'un cylindre circulaire fixe, en fonction de Re et Kc , issus des travaux de Sumer et Fredsøe [71]. Les écoulements décrits dans le tableau 5.2 se situent donc dans la zone située à la limite entre les zones (a) et (b) et marquée par le carré rouge sur la figure 5.29. Le régime est laminaire pour les plus faibles Kc ($Kc < 0.6$), ce qui correspond aux périodes inférieures à $T = 0.6$ s environ. Les vortex de Honji [48] doivent apparaître au-delà de cette limite. Les régimes à faible Kc sont considérés comme des régimes dominés par les efforts d'inertie et où les efforts de traînée sont négligeables. Dans le cas de systèmes oscillants, il est en revanche nécessaire de prendre en compte les effets visqueux, notamment autour de la résonance car leur contribution n'est alors plus négligeable [71]. La proximité des murs du canal de chaque côté du cylindre (Fig. 5.27) agit sur l'écoulement local et tend à renforcer les effets visqueux bien que cela soit difficile à quantifier.

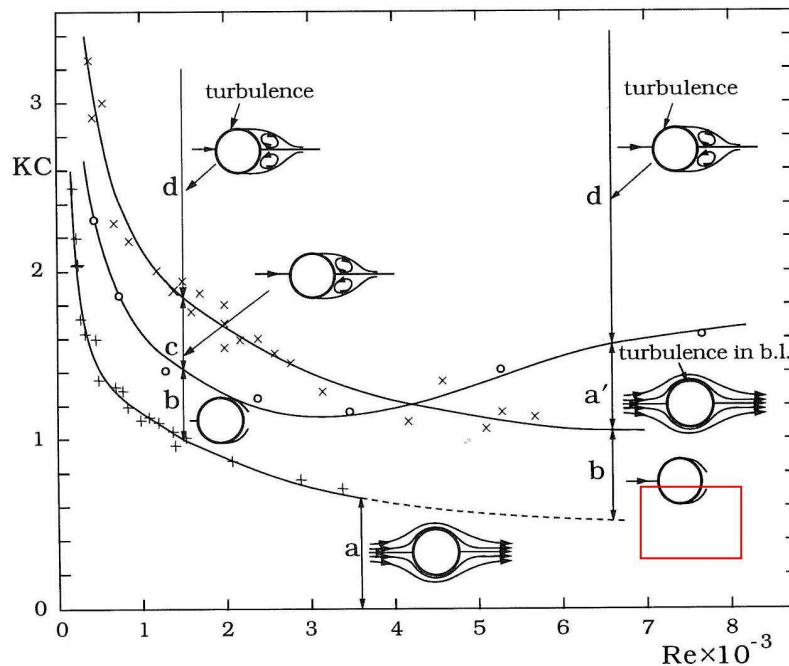

FIGURE 5.29 – Régimes de l'écoulement autour d'un cylindre circulaire lisse dans un écoulement oscillant à faible Kc ($Kc < 3$). Sur cette figure, (a) : pas de détachement tourbillonnaire, écoulement rampant ; (a') : pas de détachement, couche limite turbulente ; (b) : détachement de vortex de Honji ; (c) : paire de vortex symétriques ; (d) : paire de vortex symétriques et turbulence à la surface du cylindre. Cette figure est issue de Sumer et Fredsøe [71], qui utilise les données de Sarpkaya [66] et de Honji [48].

Nous avons généré durant les essais des houles de hauteur $H = 4$ cm et de périodes allant de $T = 1.15$ s à $T = 1.55$ s, donc correspondant à des écoulements laminaires, et aucun vortex n'a été observé visuellement lors des essais dans le canal.

5.4.4 Comparaison expériences/modèle non-linéaire

Le système a été soumis durant les essais à des vagues régulières de périodes cibles $T = 1.15, 1.25, 1.35, 1.45, 1.55$ s. Après avoir enregistré des chocs de l'aimant dans sa course qui ont parfois provoqué le décrochage du générateur au niveau de son ancrage, nous avons choisi de restreindre la hauteur des vagues à $H = 4$ cm du fait de la course maximale du générateur qui est d'environ 10 cm. Pour cette hauteur de vagues, nous n'avons pas enregistré de choc de l'aimant dans sa course durant les essais.

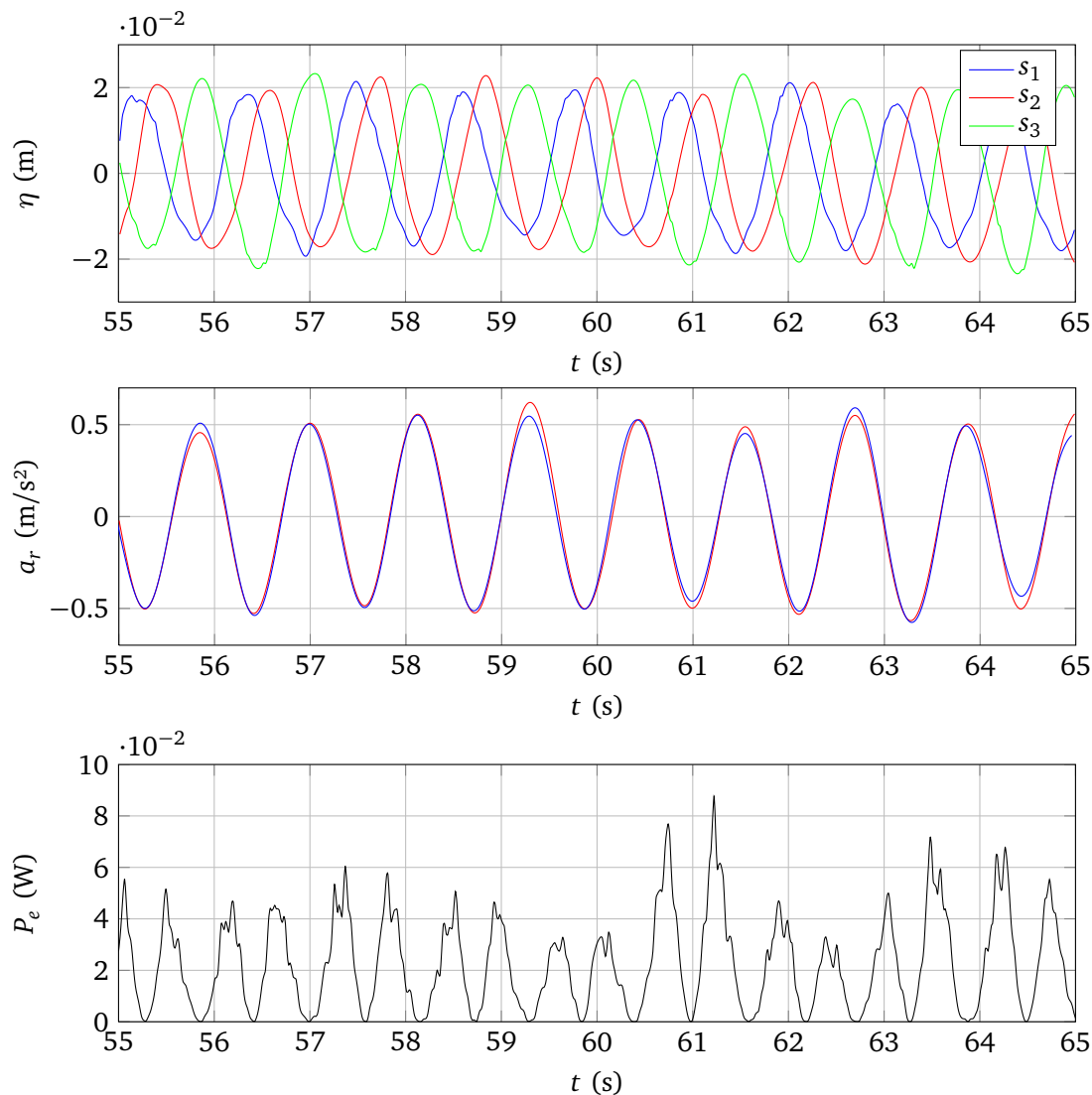

FIGURE 5.30 – De haut en bas : élévations de surface libre enregistrées par les trois sondes s_1, s_2, s_3 disposées dans le canal (voir Fig. 5.23 pour la position relative des sondes), composante radiale de l'accélération du cylindre enregistrées par chacun des deux accéléromètres, puissance électrique mesurée.

Les signaux issus des accéléromètres ont été traités, filtrés puis analysés. La figure 5.30 montre plusieurs signaux enregistrés au cours de l'un des essais, pour des conditions de vagues régulières de période cible de 1.15 s et de hauteur cible 4 cm. On distingue l'enregistrement de

la position de la surface libre par chacune des sondes disposées dans le canal, la composante radiale de l'accélération par chacun des deux accéléromètres au cours des essais, et enfin la puissance électrique P_e générée par le système, obtenue en mesurant la différence de tension aux bornes du générateur. La période des vagues mesurée sur cette fenêtre d'enregistrement est de 1.13 s pour une hauteur moyenne de 3.91 cm.

Une vague légèrement supérieure aux autres est enregistrée juste autour de $t = 58.9$ s par la sonde s_2 située 1 m environ en aval du cylindre, visible sur l'accélération à $t = 59.3$ s. La puissance créée par le générateur étant proportionnelle au carré de la vitesse radiale du cylindre, le signal de puissance P_e possède bien deux pics pour chaque période de vagues. On remarque aussi que les signaux issus des deux accéléromètres se superposent bien, ce qui indique que la dynamique du cylindre est relativement bien symétrique.

A partir de ces signaux, on mesure pour chaque test la période mesurée $T_m = 2\pi/\omega_m$ et la hauteur des vagues mesurée $H_m = 2A_m$ ainsi que la moyenne quadratique des accélérations radiales a_{rms} . L'amplitude du déplacement du cylindre dans l'axe du générateur adimensionnée par l'amplitude des vagues incidentes est obtenue à partir de la formule suivante (valable dans le cas d'un signal sinusoïdal) :

$$\frac{r}{A_m} = \frac{\sqrt{2}a_{rms}}{A_m\omega_m^2} \quad (5.42)$$

La figure 5.31 présente les résultats obtenus sur le déplacement radial adimensionné, en comparant les données des essais aux simulations numériques.

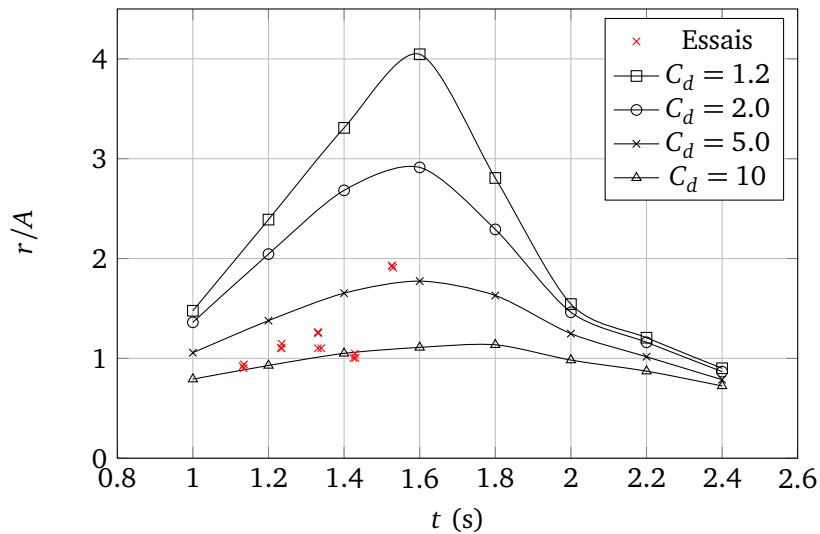

FIGURE 5.31 – Amplitude du mouvement radial adimensionné par l'amplitude des vagues incidentes pour les différentes périodes générées. Les résultats des essais (*) sont comparés aux résultats des simulations numériques pour plusieurs coefficients de traînée C_d du cylindre.

Les résultats numériques indiquent une période de résonance autour de $T = 1.6$ s. Malheureusement les essais n'ont été effectués que pour des périodes inférieures à cette valeur, ce qui ne permet pas de vérifier expérimentalement. Pour la période $T = 1.35$ s, deux séries d'essais ont été effectuées pour évaluer la reproductibilité des mesures, et l'écart observé peut être attribué à une profondeur d'immersion initiale du cylindre légèrement différente dans les deux cas. De façon générale, les amplitudes prédites par le modèle numérique sont

clairement plus importantes que celles mesurées par les essais ce qui laisse penser que les phénomènes de dissipation ou d'amortissement ne sont pas suffisamment représentés dans nos simulations. Nous avons donc fait varier le coefficient de traînée C_d pour se rapprocher des résultats expérimentaux. Augmenter la traînée visqueuse amortit sensiblement la réponse du cylindre autour de la résonance et s'accompagne d'un léger décalage du pic vers la droite. Une valeur de $C_d = 5$ permet de se rapprocher sensiblement des essais bien que cette valeur soit en dehors des valeurs prédites habituellement pour un cylindre circulaire fixe ($C_d = 0.5$ à 2).

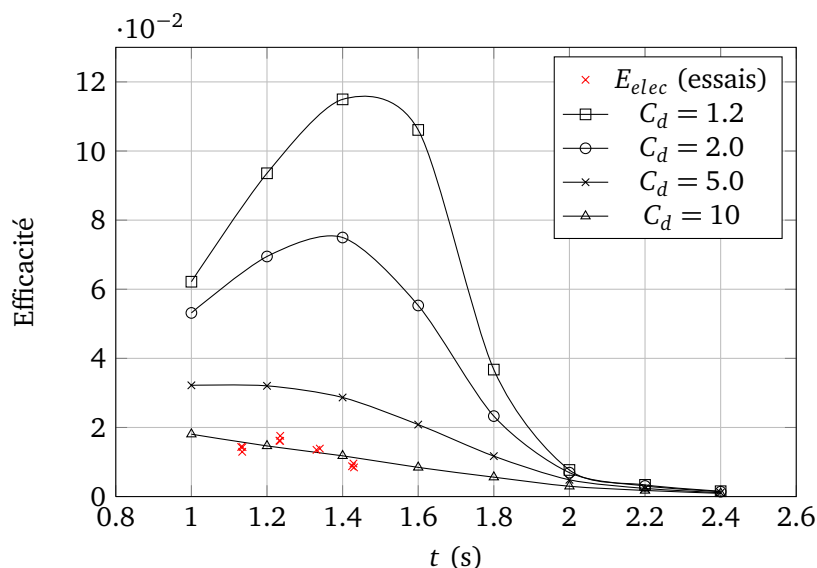

FIGURE 5.32 – Efficacité électrique du système houlomoteur en fonction de la période des vagues incidentes. Les résultats des essais (\times) sont comparés aux résultats des simulations numériques pour plusieurs coefficients de traînée C_d du cylindre.

La figure 5.32 montre l'efficacité électrique mesurée, définie comme le rapport de la puissance électrique moyenne mesurée sur la puissance moyenne des vagues incidentes, pour les périodes de vagues testées. Certains enregistrements n'ont pas fonctionné et l'efficacité pour certaines périodes de vagues n'a pu être mesurée. L'efficacité électrique mesurée est comparée à l'efficacité mécanique, définie comme le rapport de la puissance mécanique absorbée par le cylindre par la puissance moyenne des vagues incidentes, calculée numériquement pour plusieurs valeurs du coefficient de traînée. Les mesures sont proches des résultats numériques obtenus avec $C_d = 10$, bien que cette valeur soit anormalement élevée. D'autres phénomènes de dissipation doivent également être pris en compte pour représenter par exemple les pertes d'énergie lors de la conversion de l'énergie mécanique en énergie électrique.

Les essais présentés ont été effectués sur un temps très court (quelques jours), et pour la plupart par le groupe d'étudiants de Master, après la fin de mon séjour à l'Université du Rhode Island (USA). Les mesures effectuées ont permis d'obtenir des résultats en vagues régulières et irrégulières pour les mouvements bi-dimensionnels d'un système houlomoteur cylindrique immergé. Seuls les résultats en vagues régulières ont été présentés, et du travail est encore à fournir pour analyser les données en vagues irrégulières. La résonance du système n'a pu être observée expérimentalement et il serait souhaitable à l'avenir de tester des périodes de vagues allant jusqu'à 2.2 s environ. Etant limité par la l'amplitude du déplacement de l'aimant du

générateur, la hauteur des vagues générées a été limitée à 4 cm et les effets non-linéaires des vagues n'ont pu être analysés en détail. En revanche, le modèle numérique a été modifié pour prendre en compte un effort de traînée de type force de Morison. Ces essais ont été l'occasion d'appréhender les principaux problèmes et aléas liés aux expérimentations : incertitudes liées aux instruments de mesure, incertitudes provoquées par l'expérimentateur, et incertitudes sur les conditions initiales, sans compter les possibles phénomènes de réflexion des vagues dans le canal physique. Une étude numérique plus approfondie du système, préalable à la mise en bassin, aurait permis de préparer au mieux ces essais, minimiser les facteurs d'incertitudes et obtenir des résultats plus probants. La maquette du système reste disponible et pourrait servir à l'avenir pour procéder à des essais complémentaires.

5.5 Summary and intermediate conclusions from the chapter

In this chapter, we have validated the ability of our 2DV-NWT to simulate free motions of a submerged circular cylinder, restrained by a system of linear springs and dampers. In the first section, we verified the property of volume and energy conservation, in a simple configuration with a heaving cylinder in a narrow tank with lateral reflective walls. We analyzed the sensitivity to the free surface spatial discretization step and obtained a maximum relative error lower than 0.001 % for both volume and energy conservation, after 40 periods of oscillation. On the case of the Bristol cylinder wave-energy device, a good agreement was made with Evans linear theory [27, 28] on the hydrodynamic forces and cylinder displacement. We analyzed the influence of an increasing incident wave steepness onto the mean and three first harmonic amplitudes of forces and displacements. The effect of wave steepness was also analyzed on the efficiency of the device, with numerical results compared to a similar case experimented by Evans et al. [28]. Finally, we performed our own tests in the tank of University of Rhode Island on a different device, and obtained preliminary results in regular waves. Dissipation effects seem underpredicted in our simulations, and were compensated by adding a drag force into the body dynamics. Other measurements are still needed for a more complete experimental validation.

6

Applications à des SREVs simples en conditions de vagues irrégulières

On présente dans ce chapitre plusieurs applications du modèle 2DV-NWT à des Systèmes Récupérateurs d'Énergie des Vagues (SREVs) simples, en conditions de vagues irrégulières. Le modèle est étendu pour la génération de vagues irrégulières par les mouvements d'un batteur, avec une loi au premier ordre. On analyse les effets de la non-linéarité de l'état de mer et de son étalement spectral sur l'efficacité d'absorption d'un cylindre de Bristol. Un second corps est rajouté dans le modèle dont la dynamique est couplée avec le fluide de façon similaire au premier. On analyse l'influence de la distance entre deux cylindres de Bristol sur leur efficacité d'absorption d'énergie dans un état de mer irrégulier.

Contents

6.1	Introduction et objectifs du chapitre	94
6.2	Efficacité du système en vagues irrégulières	94
6.3	Interactions entre deux cylindres absorbants	100
6.4	Résumé et conclusions intermédiaires du chapitre	106

6.1 Introduction et objectifs du chapitre

Dans ce chapitre, on s'intéresse à des applications du modèle en vagues irrégulières. Greene [33] a programmé au cours de son master la génération de vagues irrégulières dans la version du code 2DV-NWT sans corps et ses développements ont été intégrés à notre modèle. Les vagues sont générées par le mouvement d'un batteur-volet dont la loi de déplacement au premier ordre est calculée à partir d'un spectre cible de JONSWAP tronqué sur un intervalle de fréquence donné. L'état de mer alors généré évolue au cours de sa propagation dans le canal, en raison notamment des effets non-linéaires. En disposant des sondes dans le canal numérique, on peut mesurer l'état de mer dans le canal à différentes abscisses et calculer le spectre correspondant par une analyse vague à vague. En comparant le spectre mesuré avec le spectre cible, la loi de batteur peut être modifiée de façon itérative pour faire converger les deux spectres. Deux applications sur le cylindre de Bristol sont étudiées dans ce chapitre. On s'intéresse d'abord à l'efficacité d'un cylindre absorbant soumis à plusieurs états de mer irréguliers dont les spectres sont de plus en plus resserrés autour de leur fréquence de pic, qui est prise égale à la fréquence de réglage du système. On teste en particulier l'influence du paramètre d'élanement γ et l'influence de la non-linéarité des vagues sur l'efficacité d'absorption. Dans un second temps, on considère le cas de deux cylindres absorbants séparés d'une distance d dont on teste l'influence sur l'efficacité de chaque cylindre. Aucune validation analytique ou expérimentale n'illustre les résultats présentés, l'objectif de ce chapitre est simplement de vérifier la pertinence du modèle et la capacité du modèle à traiter ce type d'application. Les résultats pourront ensuite être étendus pour obtenir une validation.

6.2 Efficacité du système en vagues irrégulières

Dans cette partie, on étudie l'efficacité du cylindre de Bristol soumis à des vagues irrégulières correspondant à un spectre de JONSWAP. Comme dans le chapitre précédent, on considère un cylindre horizontal de section circulaire de rayon $R = 5$ cm, dont le centre est immergé à 6.25 cm sous la surface libre au repos, dans un canal de profondeur $h = 1.2$ m. Ce cylindre absorbant est réglé à la fréquence $f_0 = 1.65$ Hz, soit $kR = 0.55$ (cf section 5.3.1).

Les vagues sont générées par le mouvement d'un batteur-volet dont l'amplitude est déduite du spectre de variance de surface libre grâce à la théorie de batteur au premier ordre [25].

L'objectif de ces simulations est de mesurer l'influence de la largeur du spectre de vagues, via le paramètre d'élanement γ du spectre de JONSWAP, sur l'efficacité du système autour de sa fréquence de réglage. Dans la suite, la fréquence de pic f_p des spectres considérés, ainsi que la fréquence f_r de la houle régulière "équivalente" sont choisies égales à la fréquence de réglage du système :

$$f_p = f_r = f_0 \tag{6.1}$$

Caractéristiques des spectres de JONSWAP considérés

Les spectres de JONSWAP considérés sont paramétrisés sous la forme habituelle d'Hasselmann et al. [47] :

$$S_J(f) = \alpha \frac{g^2}{(2\pi)^4 f^5} \exp\left(-\frac{5}{4} \left(\frac{f}{f_p}\right)^{-4}\right) \gamma \exp\left(-\frac{\left(1-\frac{f}{f_p}\right)^2}{2\sigma^2}\right) = \alpha S'_J(f) \quad (6.2)$$

où g est la gravité et σ une constante qui vaut 0.07 si $f \leq f_p$ et 0.09 sinon. Le paramètre de Phillips α est un facteur proportionnel à l'énergie du spectre ou à la variance de l'état de mer m_0 , ou encore au carré de la hauteur significative H_{m_0} . Dans la suite on note $S'_J(f)$ le spectre de JONSWAP réduit défini par :

$$S'_J(f) = S_J(f)/\alpha \quad (6.3)$$

On a alors :

$$H_{m_0}^2 = 16m_0 = 16\alpha \int_{f_{min}}^{f_{max}} S'_J(f) df \quad (6.4)$$

f_{min} et f_{max} sont les bornes de l'intervalle de fréquences sur lequel le spectre est tronqué. En pratique, seules les fréquences f qui vérifient $S_J(f) > 0.025S_J(f_p)$ sont conservées dans le spectre. La hauteur significative H_{m_0} est ensuite calculée de façon à assurer l'égalité entre le flux moyen d'énergie incident en vagues irrégulières, correspondant au spectre de JONSWAP de paramètres (H_{m_0}, f_p, γ) , et le flux d'énergie moyen incident en vagues monochromatiques de paramètres (H_r, f_r) . D'après la théorie linéaire en profondeur finie h , cette égalité des flux moyens se traduit par la relation :

$$\rho g \alpha \int_{f_{min}}^{f_{max}} c_g(f, h) S'_J(f) df = \frac{1}{8} \rho g H_r^2 c_g(f_r, h) \quad (6.5)$$

où $c_g(f, h)$ correspond à la vitesse de groupe (vitesse de l'énergie de l'état de mer) en profondeur finie h à la fréquence f . On en déduit :

$$\left(\frac{H_{m_0}}{H_r}\right)^2 = \frac{2c_g(f_r, h) \int_{f_{min}}^{f_{max}} S'_J(f) df}{\int_{f_{min}}^{f_{max}} c_g(f, h) S'_J(f) df} \quad (6.6)$$

Cette relation donne le rapport de la hauteur significative H_{m_0} en vagues irrégulières sur la hauteur de houle en vagues régulières H_r pour un même flux d'énergie moyen. L'équation (6.6) est résolue numériquement et la figure 6.1 présente l'évolution avec le paramètre γ du rapport H_{m_0}/H_r , pour $f_p = f_r = f_0 = 1.65$ Hz.

Lorsque γ tend vers l'infini, $S'_J(f)$ tend vers un Dirac centré sur $f_p = f_r$ et donc H_{m_0}/H_r tend vers $\sqrt{2}$, ce qui est bien observé sur la figure 6.1. Dans la suite, 4 valeurs de γ ($\gamma = 1, 3, 7$ et 20) et 3 valeurs de H_r ($H_r = 0.1$ mm, 1.0 mm et 1.0 cm) ont été choisies pour mesurer l'efficacité du cylindre de Bristol pour différentes conditions de cambrure et de largeur spectrale de l'état de mer. A titre d'illustration, la figure 6.2 représente les 4 spectres de JONSWAP pour le cas $H_r = 1.0$ cm.

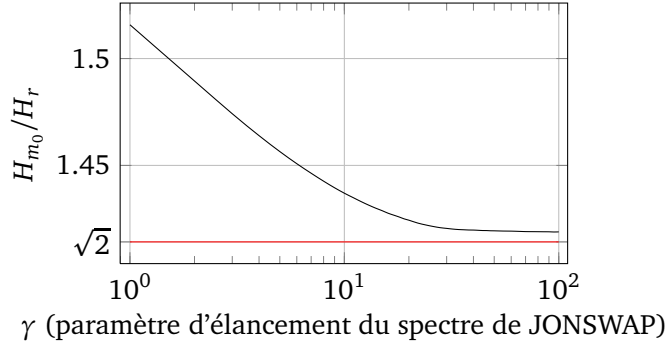

FIGURE 6.1 – Correspondance entre la hauteur de houle H_r en vagues régulières et la hauteur significative H_{m_0} en vagues irrégulières en fonction de γ , pour $f_p = f_r = f_0 = 1.65$ Hz, d'après la théorie linéaire en profondeur finie.

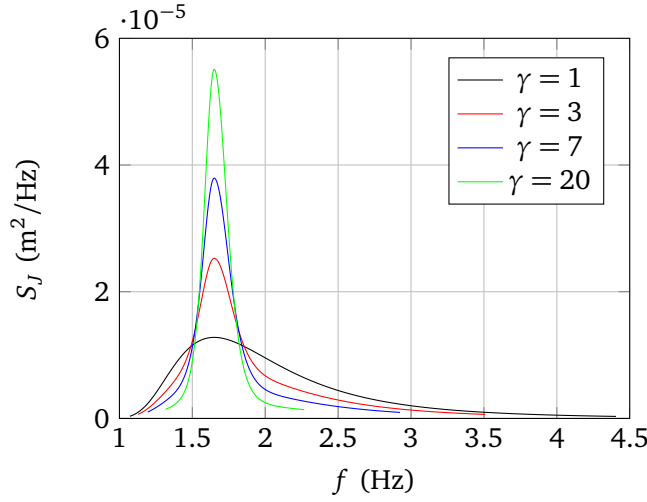

FIGURE 6.2 – Spectres de JONSWAP ($f_p = 1.65$ Hz) pour $H_r = 1$ cm et 4 valeurs de γ , tronqués sur l'intervalle $[f_{min}f_{max}]$.

Résultats numériques

Dans le cas des vagues irrégulières, on définit de façon similaire au cas des vagues régulières (Eq. (5.23)) la notion d'efficacité E du système comme le rapport de la puissance moyenne absorbée par le cylindre $\langle \mathcal{P}_{abs} \rangle$ sur le flux incident d'énergie moyen $\langle \Phi_i \rangle$.

$$E = \frac{\langle \mathcal{P}_{abs} \rangle}{\langle \Phi_i \rangle} \quad (6.7)$$

En revanche, au lieu d'être moyennées sur la période de la houle comme dans le cas de vagues monochromatiques, les quantités $\langle \mathcal{P}_{abs} \rangle$ et $\langle \Phi_i \rangle$ sont moyennées sur la durée totale \mathcal{D} de la simulation. Ainsi le flux moyen d'énergie vaut :

$$\langle \Phi_i \rangle = \frac{1}{\mathcal{D}} \int_0^{\mathcal{D}} \Phi_i(t) dt \quad (6.8)$$

La durée \mathcal{D} de nos simulations est de 150 s, ce qui représente à peu près 250 fois la période

de pic $T_p = 1/f_p$. $\Phi_i(t)$ est le flux (non-linéaire) instantané d'énergie, défini par :

$$\Phi_i(t) = -\rho \int_{-h}^{\eta(t)} \phi_x \phi_t dt \quad (6.9)$$

Comme dans la partie précédente, le flux moyen incident est calculé à la position moyenne du cylindre mais en l'absence du cylindre pour éviter toute réflexion parasite (ie chaque simulation en vagues irrégulières est effectuée deux fois avec exactement le même mouvement de batteur numérique, une fois sans le cylindre et une fois avec le cylindre).

Pour ces simulations, 300 nœuds sont utilisés pour discrétiser la surface libre, ce qui correspond à environ 30 nœuds par longueur d'onde λ_p ($\lambda_p = 0.57$ m étant la longueur d'onde correspondant à la fréquence de pic f_p , donnée par la relation de dispersion linéaire), avec une plage absorbante sur $4\lambda_p$, et 60 nœuds sur le cylindre. Les figures 6.3 et 6.4 montrent l'élévation de surface libre, le flux incident et la puissance absorbée au cours du temps, respectivement pour $\gamma = 1$ et $\gamma = 20$. Les deux figures correspondent à un même flux incident moyen $\langle \Phi_i \rangle$ équivalent, de l'ordre de $5.8 \cdot 10^{-6}$ W/m. Le signal de la puissance absorbée \mathcal{P}_{abs} présente des allures différentes pour les 2 valeurs de γ . Pour $\gamma = 1$, le signal est plus irrégulier du fait d'une largeur spectrale plus importante (Fig. 6.3). Pour $\gamma = 20$, la production de puissance est davantage concentrée sous forme de "bouffées" intermittentes, en raison d'un effet plus marqué de groupements de vagues pour cette valeur élevée de γ (Fig. 6.4).

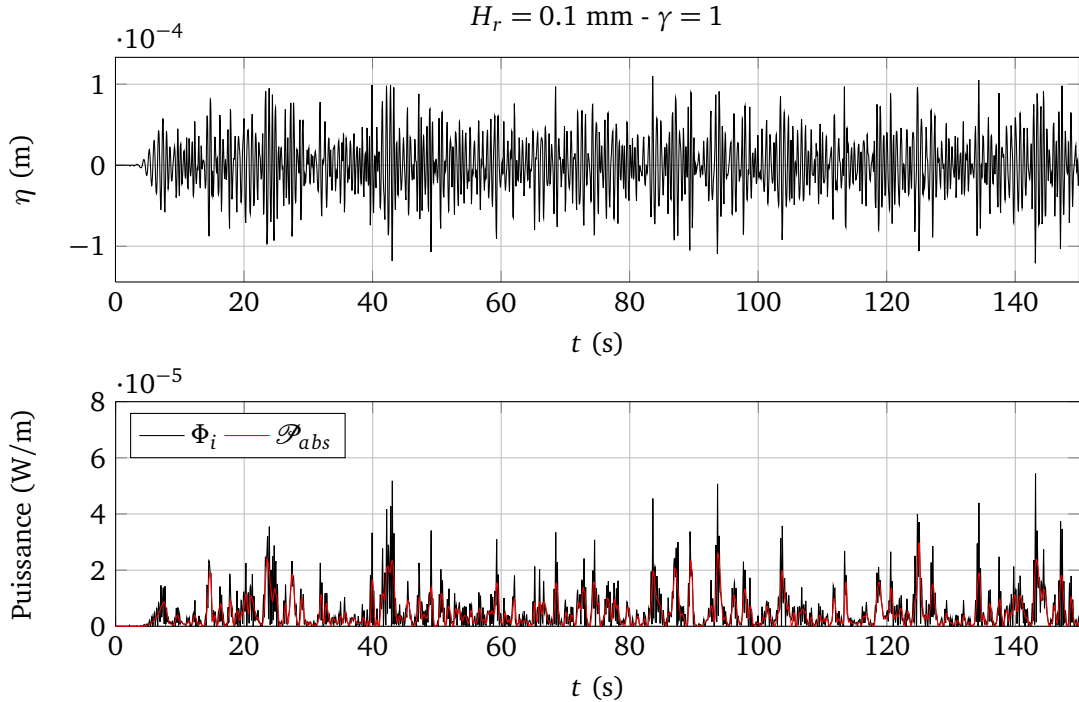

FIGURE 6.3 – En haut : élévation de surface libre η à l'abscisse moyenne du cylindre. En bas : flux incident Φ_i et puissance absorbée \mathcal{P}_{abs} , pour $H_r = 0.1$ mm et $\gamma = 1$.

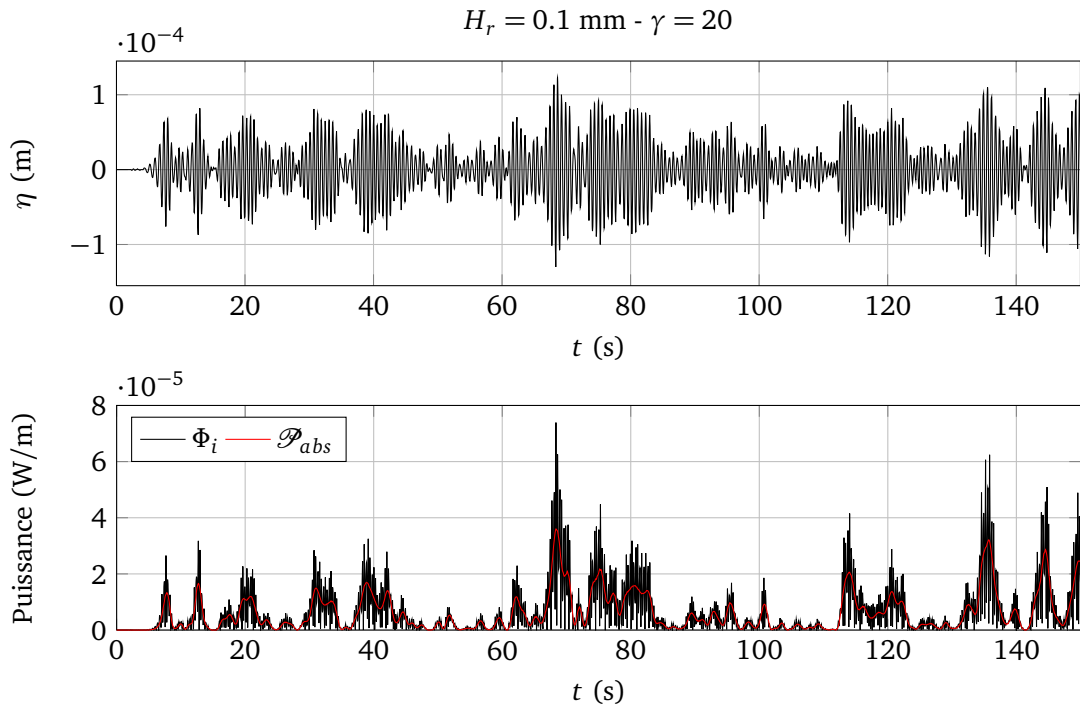

FIGURE 6.4 – En haut : élévation de surface libre η à l’abscisse moyenne du cylindre. En bas : flux incident Φ_i et puissance absorbée \mathcal{P}_{abs} , pour $H_r = 0.1 \text{ mm}$ et $\gamma = 20$.

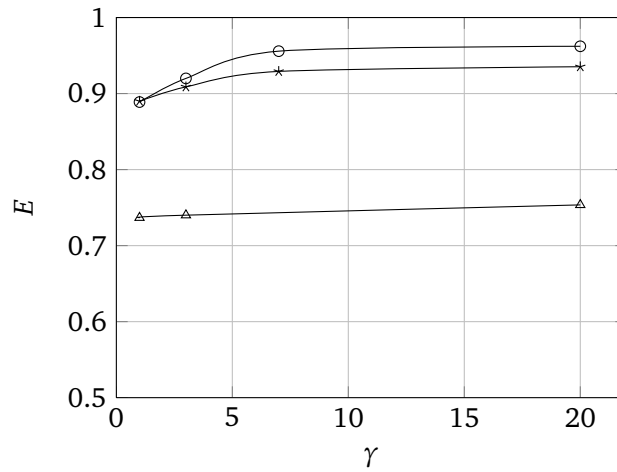

FIGURE 6.5 – Efficacité du cylindre de Bristol en fonction du facteur d’étalement spectral γ en vagues irrégulières, pour 3 hauteurs de vagues régulières équivalentes : $H_r = 0.1 \text{ mm}$ (\circ), 1.0 mm ($*$) et 1.0 cm (\triangle).

Au total 12 cas ont été simulés (3 valeurs de $H_r \times 4$ valeurs de γ).

La figure 6.5 montre l'efficacité E du système en vagues irrégulières, en fonction de l'étalement spectral γ , pour les 3 hauteurs de vagues régulières équivalentes.

Logiquement lorsque l'énergie se concentre autour de la fréquence de pic qui est aussi la fréquence de réglage ici ($f_0 = f_p$), c'est-à-dire lorsque γ augmente, le système est de plus en plus efficace. Ce gain d'efficacité est d'autant plus important que l'état de mer est moins cambré. L'efficacité semble tendre vers une asymptote lorsque γ augmente. On rappelle que l'efficacité en vagues régulières pour $f = f_0$ est égale à 1 d'après la théorie linéaire d'Evans et al. [28]. Nous avons obtenu numériquement une efficacité de 96.6% en vagues régulières pour les vagues de plus faible cambrure ($H/\lambda = 0.05\%$) à la fréquence de réglage, valeur qui est cohérente avec l'asymptote horizontale pour $H_r = 1$ mm.

On note aussi que le système perd en efficacité lorsque H_r augmente : ce résultat est en accord avec l'effet de la non-linéarité de l'état de mer déjà observé en vagues monochromatiques (voir 5.3.2 et Fig. 5.20).

6.3 Interactions entre deux cylindres absorbants

Nous avons étendu le modèle 2DV-NWT pour prendre en compte la présence d'un second corps immergé, indépendant du premier, placé en amont ou en aval de celui-ci. La dynamique de ce second corps est résolue par la méthode implicite décrite au chapitre 2 (voir §2.7.2), de façon similaire au cas d'un corps unique. Les équations du mouvement de chaque corps sont intégrées simultanément, à l'aide du schéma implicite de Newmark présenté au chapitre 2 (voir §3.4.2). La boucle prédictor-correcteur a été modifiée de façon à converger simultanément à chaque itération sur les forces et moments hydrodynamiques exercés sur chaque corps à l'itération suivante. Ainsi, la dynamique de chaque corps est calculée en prenant en compte les effets d'interactions possibles entre les deux corps, grâce au terme de pression hydrodynamique.

Les applications de ce modèle à plusieurs corps sont nombreuses : dans la perspective d'un développement industriel de fermes houlomotrices composées de plusieurs systèmes, la question de l'arrangement relatif entre ces systèmes est primordiale. En effet, comme mentionné par Babarit [6] et plus récemment par Borgarino dans sa thèse [13], les interactions entre deux systèmes peuvent être soit constructives, à savoir que la puissance moyenne absorbée par chaque système au sein de la ferme est supérieure à la puissance moyenne absorbée par un système seul, soit, au contraire, destructives. Ces effets dépendent bien entendu des conditions de vagues incidentes, de la forme de chaque corps et de sa dynamique, ainsi que de l'espacement et des positions relatives entre ces corps. On propose ici de tester de façon purement qualitative l'influence de l'écartement d entre deux cylindres absorbants identiques sur leur efficacité relative. Les deux systèmes houlomoteurs, semblables au Cylindre de Bristol introduit au chapitre précédent (voir §5.3), absorbent l'énergie des vagues incidentes dans les deux degrés de liberté (pilonnement et cavement).

Cas d'étude

Ces systèmes sont soumis à des vagues irrégulières représentatives d'un spectre de JONSWAP de paramètres : $H_{m_0} = 0.1$ m, $T_p = 1.0$ s et $\gamma = 3.3$. Chaque cylindre subit des efforts de rappel élastique de raideur $K = 292$ N/m² et d'amortissement linéaire $D = 50$ kg.m⁻¹.s⁻¹, pris égaux dans les directions horizontales et verticales et choisis arbitrairement. Ces cylindres horizontaux de section circulaire de rayon $R = 5$ cm ont leur centre immergé à $z_c = -0.2$ m sous la surface libre au repos. Le canal est de longueur $L = 17$ m et de hauteur $h = 1$ m, avec une plage absorbante sur les 7 derniers mètres. Le premier cylindre, celui en amont, est disposé à 3 m du batteur-volet, et le second cylindre est placé à une distance d (distance entre les centres des deux cylindres situés à la même côte) en aval du premier cylindre. On teste dans la suite l'influence de l'espacement adimensionné d/λ_p sur l'efficacité d'absorption des deux systèmes, où $\lambda_p = 1.56$ m est la longueur d'onde correspondant à la période pic $T_p = 1$ s du spectre de JONSWAP et est calculée par la relation de dispersion linéaire.

16 espacements adimensionnés d/λ_p variant de $\lambda_p/10$ à $4\lambda_p$ sont considérés dans la suite. Le profil du canal utilisé dans les simulations numériques est illustré sur la figure 6.6. La durée de chaque simulation est de $300T_p = 300$ s, avec une résolution de 18 nœuds par longueur d'onde λ_p sur la surface libre, qui est remaillée à chaque itération. La série temporelle du mouvement du batteur est exactement la même dans chaque cas, ainsi que le train de vagues incidentes générées.

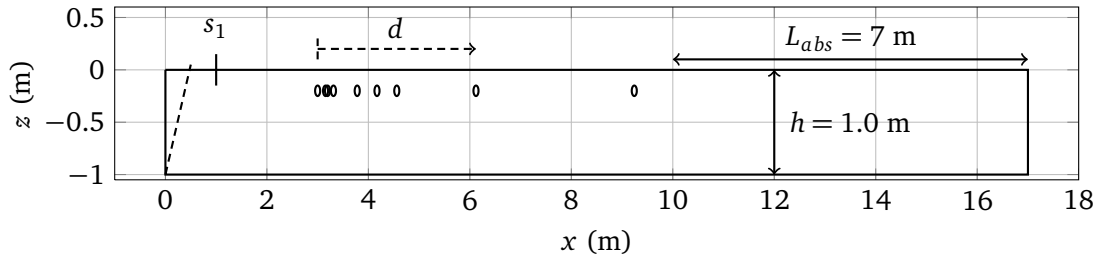

FIGURE 6.6 – Géométrie du canal à houle considéré, positions des deux cylindres et de la sonde s_1 . 16 cas sont considérés avec un écartement adimensionné d/λ_p variant de 0.1 à 4.

Pour chaque simulation, trois sondes s_1 , s_2 et s_3 sont placées en amont, au milieu et en aval des deux cylindres pour mesurer l'élévation de surface libre avant et après chaque cylindre. Le flux incident d'énergie moyen, noté $\langle \Phi_i \rangle$, est mesuré par la première sonde s_1 en présence des deux cylindres. On mesure également la puissance instantanée absorbée par chaque cylindre, respectivement notée \mathcal{P}_{abs}^1 pour le cylindre amont et \mathcal{P}_{abs}^2 pour le cylindre aval. On note également $\langle \mathcal{P}_{abs}^i \rangle$ la puissance absorbée par le i -ème cylindre moyennée sur toute la simulation. Une simulation de référence avec le cylindre, un seul (toujours placé à 3 m du batteur), est aussi réalisée, et la puissance moyenne absorbée par ce dernier est noté $\langle \mathcal{P}_{abs}^0 \rangle$.

Résultats numériques

Mesure des états de mer Le spectre des états de mer mesurés par les sondes s_1 , s_2 et s_3 est reconstitué par une analyse spectrale et comparé au spectre cible de paramètres $H_{m_0} = 0.1$ m, $T_p = 1.0$ s et $\gamma = 3.3$. Les figures 6.7, 6.8 et 6.9 présentent les spectres mesurés en amont, au milieu et en aval des deux cylindres absorbants, pour trois espacements. L'état de mer mesuré par la première sonde est représentatif du spectre cible, l'accord le moins bon étant observé lorsque les cylindres sont les plus proches (Fig. 6.7). Il est probable que la proximité des deux cylindres crée une plus grande réflexion en amont du canal, les deux corps pouvant être assimilés en première approximation à un unique corps. Les spectres mesurés au milieu et en aval des deux cylindres sont logiquement moins énergétiques que le spectre incident, mais présentent une allure similaire. La comparaison entre les spectres mesurés aux sondes s_1 et s_2 d'une part, et entre ceux mesurés aux sondes s_2 et s_3 d'autre part, montre que la quantité d'énergie prélevée par le premier cylindre semble plus importante que celle absorbée par le second.

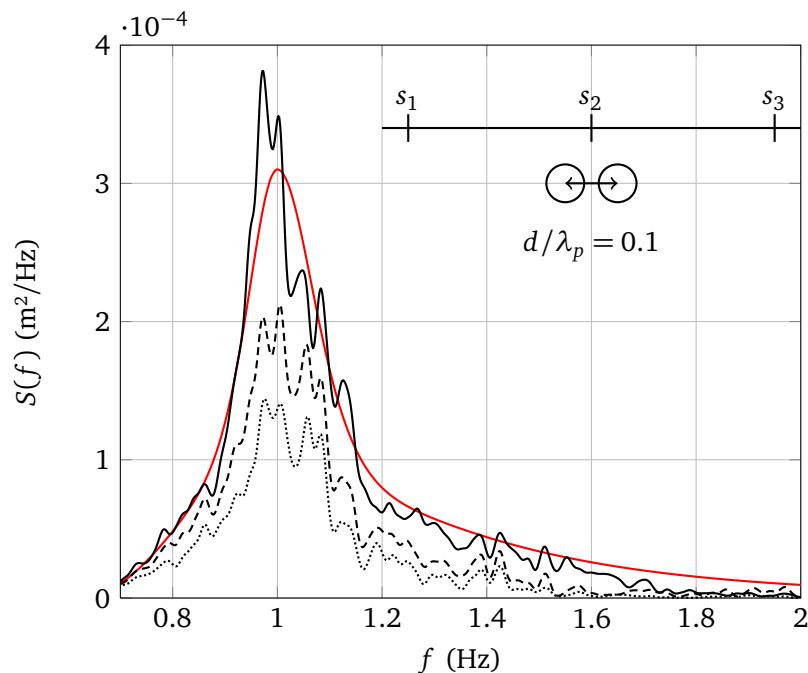

FIGURE 6.7 – Pour $d/\lambda_p = 0.1$, spectres de variance mesurés par les trois sondes s_1 (—), s_2 (---) et s_3 (.....), comparés au spectre cible (—).

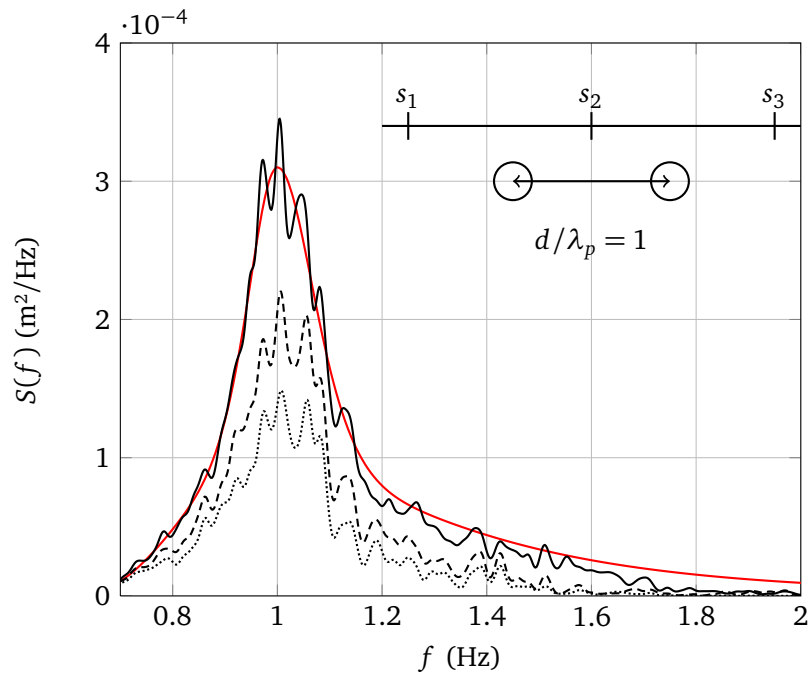

FIGURE 6.8 – Pour $d/\lambda_p = 1$, spectres de variance mesurés par les trois sondes s_1 (—), s_2 (----) et s_3 (.....), comparés au spectre cible (—).

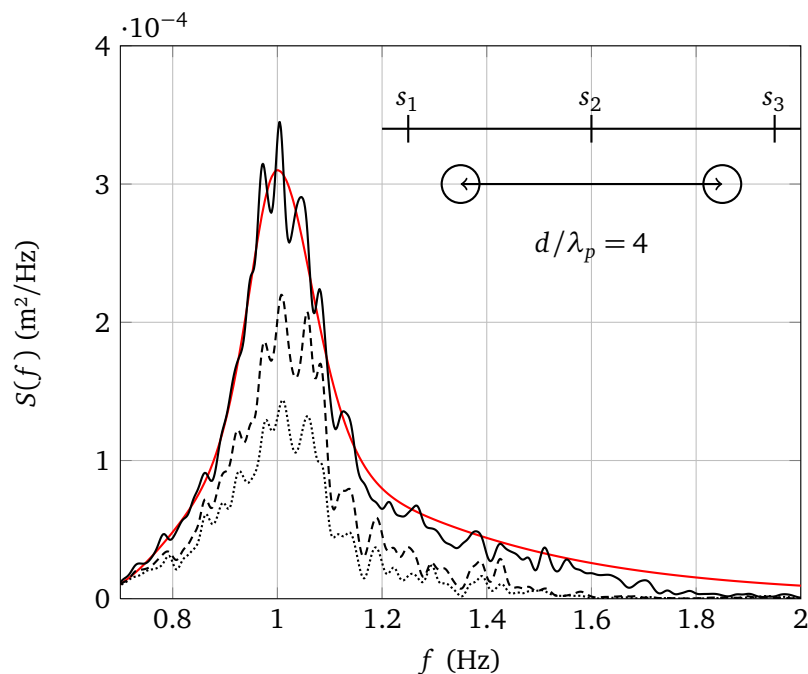

FIGURE 6.9 – Pour $d/\lambda_p = 4$, spectres de variance mesurés par les trois sondes s_1 (—), s_2 (----) et s_3 (.....), comparés au spectre cible (—).

Efficacité de l'ensemble La figure 6.10 montre la puissance absorbée au cours du temps par chacun des cylindres, pour trois espacements : $d/\lambda_p = 0.1$, $d/\lambda_p = 1$ et $d/\lambda_p = 4$.

Pour $d/\lambda_p = 0.1$, les deux cylindres sont très proches (un écart de 5.6 cm seulement sépare leurs deux extrémités, soit à peine plus d'un rayon de cylindre) et les signaux de puissance sont quasiment en phase, avec des pics d'absorption de plus grande intensité pour le cylindre amont (en bleu sur la figure). Lorsque le cylindre aval est éloigné de λ_p , le déphasage entre les deux signaux est plus net et les pics d'absorption du premier cylindre sont plus élevés. L'absorption du cylindre aval est moins forte et ses pics semblent moins fréquents. Visuellement, il semble qu'il y ait en revanche peu de différence sur l'absorption du cylindre amont entre l'espacement intermédiaire ($d/\lambda_p = 1$) et le grand espacement ($d/\lambda_p = 4$).

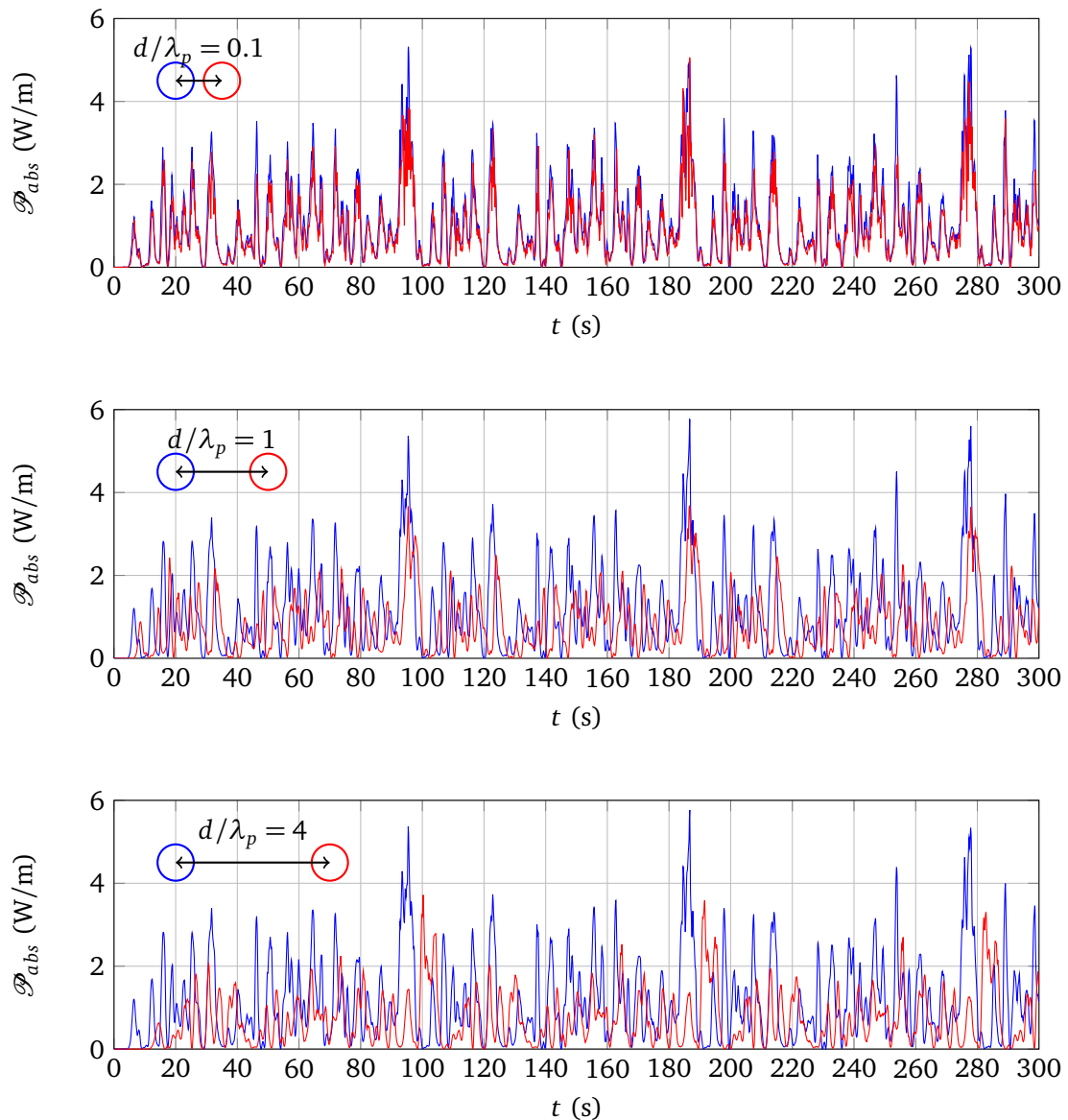

FIGURE 6.10 – Puissance absorbée instantanée par les cylindres amont (—) et aval (—), pour $d/\lambda_p = 0.1$ (en haut), $d/\lambda_p = 1$ (au milieu) et $d/\lambda_p = 4$ (en bas).

On définit ici l'efficacité E_i du cylindre i , par l'équation (6.7), comme le rapport de la puissance moyenne absorbée $\langle \mathcal{P}_{abs}^i \rangle$ sur le flux moyen incident d'énergie $\langle \Phi_i \rangle$. La figure 6.11 montre l'efficacité de chaque cylindre en fonction de l'espacement adimensionné d/λ_p . Comme observé sur les spectres mesurés dans le canal, l'absorption est plus efficace par le cylindre amont, quelle que soit l'écart entre les deux cylindres. En revanche, la proximité des deux corps favorise l'absorption par le second cylindre tandis que le cylindre amont semble perturbé par la présence du cylindre aval. A grand espacement, l'efficacité du cylindre amont tend vers une valeur asymptotique $E_0 \approx 15.7\%$ qui correspond à l'efficacité d'un seul cylindre. Le cylindre aval n'a donc plus d'influence sur le cylindre amont au-delà de $d/\lambda_p = 0.75$.

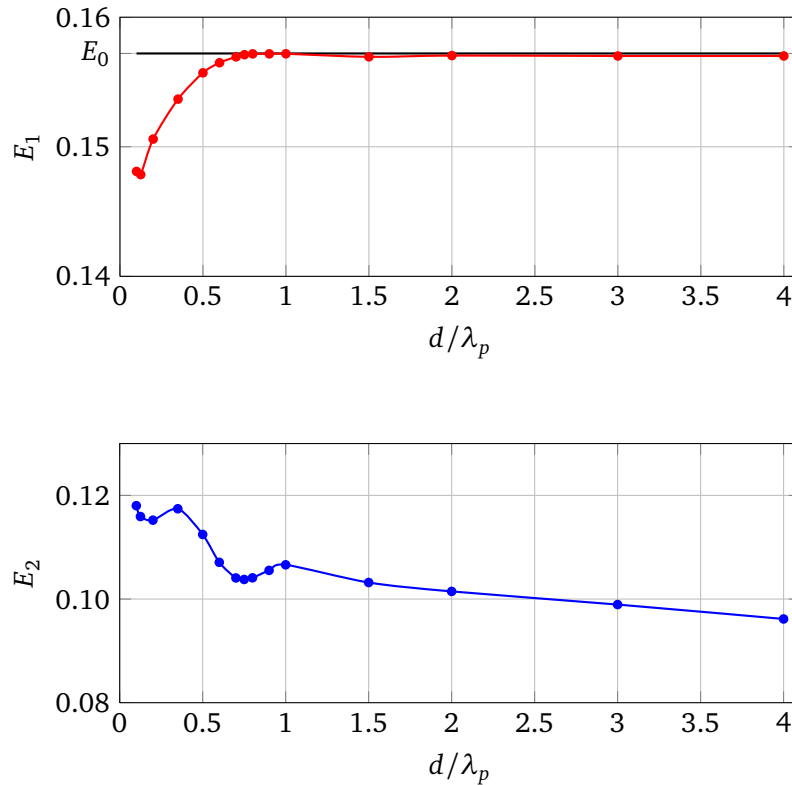

FIGURE 6.11 – Efficacité E_1 du cylindre amont (—●—) et E_2 du cylindre aval (—●—) en fonction de l'écartement adimensionné d/λ_p , comparé à l'efficacité E_0 d'un cylindre seul (—).

En revanche, le cylindre aval exposé à un état de mer modifié par le cylindre amont, a son efficacité maximale autour de $d/\lambda_p = 0.4$, mais subit une baisse locale d'absorption autour de $d/\lambda_p = 0.75$ et diminue ensuite avec la distance. On s'attend à ce que E_2 tende vers une valeur asymptotique, mais cela n'a pu être vérifié numériquement, en raison notamment des limites sur la taille choisie du canal. Il est possible qu'en éloignant le cylindre aval du cylindre amont, le cylindre aval subit une influence grandissante de la plage absorbante bien que ce dernier soit toujours situé avant la plage. Cette hypothèse mériterait d'être confirmée en adaptant la taille du canal pour garder une distance constante entre le cylindre aval et le début de la plage absorbante. Les possibles réflexions dans le canal des ondes les plus longues, plus difficiles à absorber par la plage, pourraient également perturber le cylindre aval et son efficacité.

On définit le facteur $q = (E_1 + E_2)/2E_0$, où E_0 désigne l'efficacité d'un cylindre seul. Ce paramètre mesure l'efficacité de l'ensemble des deux cylindres et est représenté sur la figure 6.12. Constamment inférieur à 1, il indique qu'il n'y a pas d'interaction constructive pour le cas considéré et une telle configuration à deux cylindres reste moins efficace que deux cylindres absorbants indépendants. L'espacement le plus intéressant énergétiquement ($q \approx 0.87$) se situe autour de $d/\lambda_p = 0.4$, la distance qui correspond au meilleur compromis entre l'efficacité du premier et l'efficacité du second cylindre.

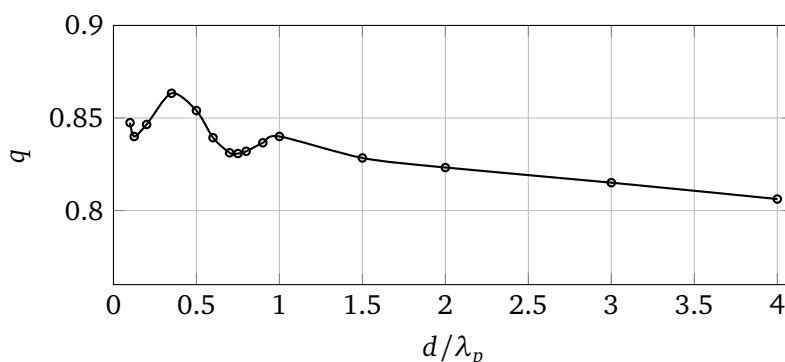

FIGURE 6.12 – Facteur q en fonction de l'écartement adimensionné d/λ_p .

Cette variation du facteur q avec d/λ_p a été ici obtenue pour un spectre particulier et une seule réalisation (série temporelle de vagues) de ce spectre. Des simulations complémentaires pourraient être réalisées pour confirmer ces observations.

6.4 Résumé et conclusions intermédiaires du chapitre

Dans ce chapitre, la génération de train de vagues irrégulières par le mouvement d'un batteur volet a été intégré au modèle 2DV-NWT. Un cylindre absorbant, de type cylindre de Bristol, a été soumis à des états de mer représentatifs de spectres de JONSWAP de plus en plus resserrés autour de leur fréquence de pic, et dont le flux d'énergie est constant. Les paramètres d'extraction de l'énergie du système ont été calibrés pour maximiser son efficacité à la fréquence de pic des spectres générés, à l'aide de la théorie linéaire d'Evans [27]. L'influence du paramètre d'élanement γ du spectre de JONSWAP sur l'efficacité du cylindre a ensuite été mesurée pour des états de mer plus ou moins énergétiques. Une augmentation de l'efficacité du système est observée pour les distributions les moins étalées, avec un gain d'efficacité plus important pour les états de mer les moins énergétiques. A γ constant, l'efficacité du système est meilleure pour les états de mer les moins énergétiques qui correspondent aux vagues les moins cambrées, un résultat déjà observé en vagues monochromatiques (voir §5.3.2).

Puis, un second corps mobile a été intégré au modèle 2DV-NWT, dont la dynamique est calculée de façon similaire au premier corps. L'influence de la distance qui sépare deux cylindres absorbants identiques a été mesurée sur l'efficacité de l'ensemble, mais aucune interaction constructive n'a pu être observée pour le cas considéré. D'autres configurations de deux cylindres absorbants pourraient être testées à l'avenir, et les résultats du modèle mériteraient notamment d'être comparés à la théorie linéaire développée pour deux corps par Srokosz et Evans [70].

7

Extension du modèle numérique en 3D

Ce chapitre présente les premiers résultats obtenus avec le modèle NWT-3D, dans lequel nous avons implémenté une sphère rigide immergée pouvant décrire des mouvements de grande amplitude, forcés ou libres, dans les trois directions d'espace. Deux applications numériques sont présentées : une sphère en pilonnement forcé et une sphère en pilonnement libre, immergée dans un bassin de surface carrée initialement au repos. Ces premières simulations 3D permettent notamment de préciser les besoins en ressources informatiques.

Contents

7.1 Introduction et objectifs du chapitre	108
7.2 Le bassin à houle 3D	108
7.3 Discrétisation de la sphère	109
7.4 Mouvement forcé de pilonnement de grande amplitude	111
7.5 Mouvement libre de pilonnement de grande amplitude	114
7.6 Analyse des temps CPU sur les calculs 3D	116
7.7 Résumé et conclusions intermédiaires du chapitre	116

7.1 Introduction et objectifs du chapitre

Dans les chapitres 4 à 6, le modèle NWT-2DV a été validé sur un ensemble d'applications pour le cas d'un cylindre circulaire horizontal. Nous avons tout récemment modifié le canal à houle NWT-3D développé par Grilli et ses collaborateurs [37, 45, 36], qui résout également les équations de la théorie potentielle complètement non-linéaire, pour prendre en compte la présence d'une sphère rigide immergée pouvant décrire des mouvements de grande amplitude. L'objectif de ce chapitre est de démontrer la faisabilité d'applications 3D, sur des cas simples de pilonnement, imposé ou libre, d'une sphère immergée dans un bassin de surface carrée, avec des parois latérales réfléchissantes.

Ce travail préliminaire vise avant tout à défricher et préparer des travaux ultérieurs, tout en établissant un "état zéro" des besoins en ressources informatiques pour les applications 3D.

7.2 Le bassin à houle 3D

De même que le canal 2D, le bassin à houle 3D résout les équations de la théorie potentielle non-linéaire par la méthode des éléments de frontière d'ordre élevé, avec deux équations intégrales, une sur le potentiel ϕ et l'autre sur sa dérivée temporelle ϕ_t . Les six parois du domaine (le mur côté batteur Γ_{r1} , la surface libre Γ_f , le mur aval et les parois latérales qui peuvent jouer le rôle de parois absorbantes Γ_{r2} , et le fond Γ_b) sont discrétisées par des quadrilatères composés de 4×4 nœuds et associés à des fonctions de forme bi-cubiques. Chaque élément est donc formé de 9 sous-quadrilatères parmi lesquels un seul est utilisé pour l'interpolation, selon la position de l'élément par rapport aux bords du canal 3D (pour plus d'informations, voir [45]).

Nous avons implémenté une septième frontière Γ_c représentant un corps immergé, comme illustré sur la figure 7.1. Pour l'instant, seul le cas d'une sphère, de rayon R , a été considéré et traité.

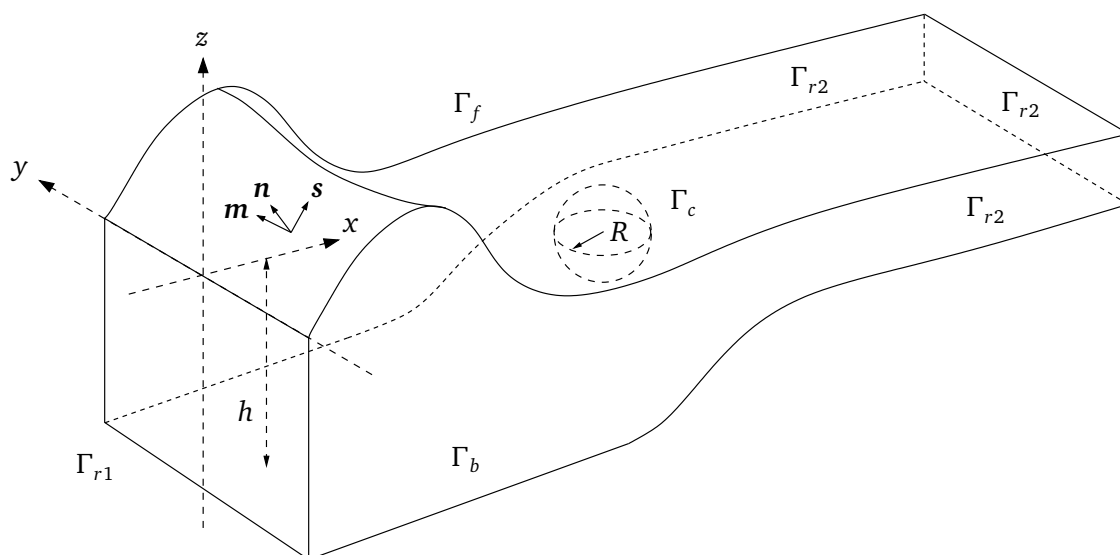

FIGURE 7.1 – Schéma du bassin à houle 3D et des différentes frontières.

La fonction de Green de l'équation de Laplace utilisée dans le modèle 3D diffère de celle du 2D et est rappelée ci-dessous, ainsi que sa dérivée normale. Par souci de synthèse, le lecteur est renvoyé aux références [37, 45, 36] pour plus de détails sur la résolution numérique spécifique au 3D.

$$\begin{cases} G = \frac{1}{4\pi r} & (7.1) \\ \frac{\partial G}{\partial n} = -\frac{1}{4\pi} \frac{\mathbf{r} \cdot \mathbf{n}}{r^3} & (7.2) \\ r = |\mathbf{r}| = |\mathbf{x} - \mathbf{x}_l| & (7.3) \end{cases}$$

Comme pour le modèle 2D, le pas de temps est imposé par le solveur hydrodynamique.

7.3 Discrétisation de la sphère

Discrétiser une sphère avec uniquement des quadrilatères n'est pas chose facile. Nous avons utilisé la pixelisation HEALPix (Hierarchical Equal Area isoLatitude Pixelization) développée par la NASA pour l'analyse astrophysique [1]. Le principe consiste à séparer la sphère en 12 quadrilatères de base, de même taille. Chacun de ses quadrilatères peut ensuite être divisé en 4, 16, 64... sous-quadrilatères, pour une résolution plus fine (voir Fig. 7.2).

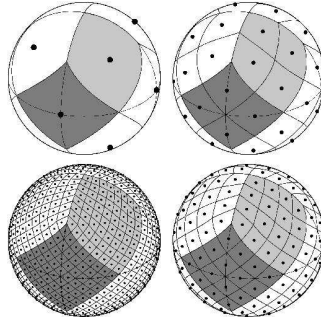

FIGURE 7.2 – Principe de la pixelisation HEALPix (image tirée de [1]).

Les éléments de base, ainsi que les éléments glissants ont été construits sous Matlab grâce au package MEALPIX, développé par le GWAstro Research Group (disponible sur <http://gwastro.psu.edu/>). Un maillage de la sphère unité par $12 \times 16 = 192$ éléments et 194 nœuds, utilisé en pratique, est illustré sur la figure 7.3.

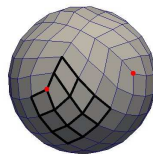

FIGURE 7.3 – Maillage HEALPIX de la sphère avec 192 quadrilatères pour 194 nœuds. En rouge : 2 nœuds à l'intersection de 3 arêtes qui perturbent la construction de l'élément glissant 4×4 nœuds (en noir).

Ce maillage a pour défaut de présenter au total 8 nœuds à l'intersection de 3 arêtes. Ceux-ci posent problème car l'élément glissant de 4×4 nœuds utilisé pour l'interpolation et le calcul des dérivées tangentielles ne peut glisser lorsqu'il rencontre ces nœuds particuliers. Face à cette difficulté, nous avons fait le choix ici de "contourner" ces nœuds en décalant l'interpolation sur le bord. Cela a notamment pour conséquence que les vecteurs locaux tangentiels ne sont pas parfaitement continus au voisinage de ces nœuds. Une discrétisation par des triangles à 6 nœuds permettrait de discrétiser des formes géométriques plus complexes. Il faudrait alors redéfinir les interpolations locales et les fonctions de forme. Un tel développement ne pouvait cependant pas être mené à l'échelle de cette thèse, sur le temps consacré aux calculs exploratoires 3D.

Nous avons donc intégré ce premier maillage de la sphère au modèle 3D et des premières simulations d'une sphère en pilonnement forcé et libre dans un bassin de surface carrée ont été réalisées.

7.4 Mouvement forcé de pilonnement de grande amplitude

On considère une sphère de rayon $R = 10$ cm, totalement immergée, dont le centre se situe initialement à $z_c = -0.5$ m $= -5R$ au centre d'un bassin de section carrée de dimensions $L_x = L_y = 5$ m $= 50R$ et de hauteur d'eau au repos $h = 1$ m $= 10R$. $M_x = M_y = 50$ éléments sont utilisés dans les deux directions horizontales et $M_z = 5$ éléments sur la verticale. La sphère est discrétisée avec 192 éléments, ce qui donne un total de 6192 éléments. La sphère est graduellement mise en oscillation de pilonnement d'amplitude $A = 0.25$ m $= 2.5R$ et de période $T = 1$ s, avec une rampe en temps de 3.5 s $= 3.5T$. On considère ici un mouvement de pilonnement pur, la sphère restant immobile dans les deux directions horizontales. La durée de la simulation est de 10 s $= 10T$ avec un pas de temps initial d'environ 0.01 s $= T/100$ qui reste relativement constant pendant la durée de la simulation. On impose des conditions de non-glissement sur les parois latérales du bassin et les vagues radiées par la sphère sont réfléchies et interagissent avec les vagues incidentes, comme visualisé sur la série d'images présentées sur la figure 7.5.

La figure 7.4 montre le déplacement vertical imposé du centre de la sphère et la composante verticale de la force hydrodynamique totale qui inclut la poussée d'Archimède, constante, $4/3\rho g\pi R^3 \approx 41.1$ N, en fonction du temps.

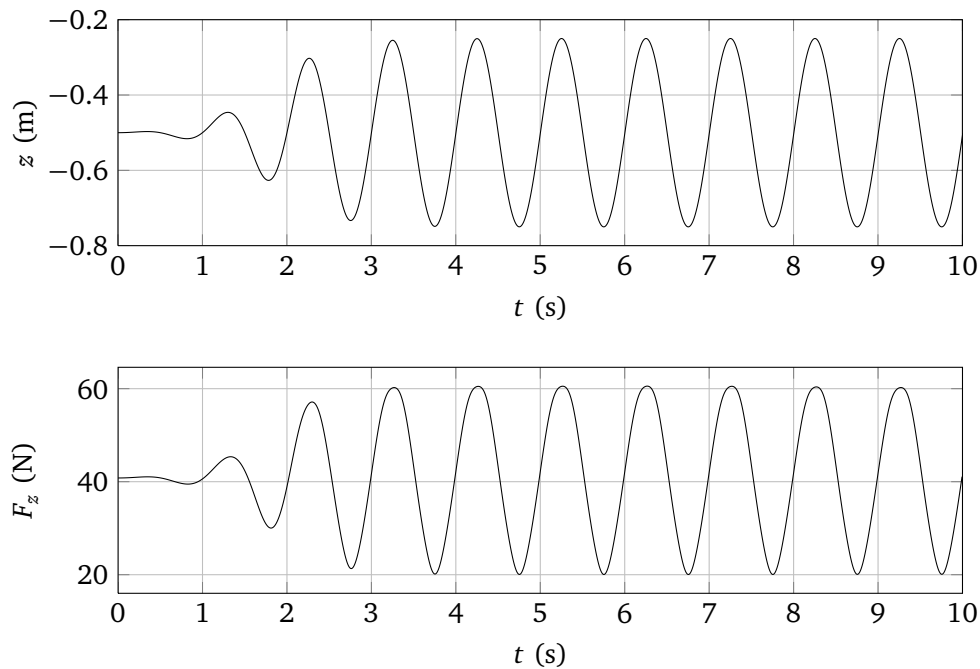

FIGURE 7.4 – En haut : déplacement vertical imposé du centre de la sphère. En bas : composante verticale de la force de pression hydrodynamique totale sur la sphère (qui inclut la poussée d'Archimède, constante, $4/3\rho g\pi R^3 \approx 41.1$ N).

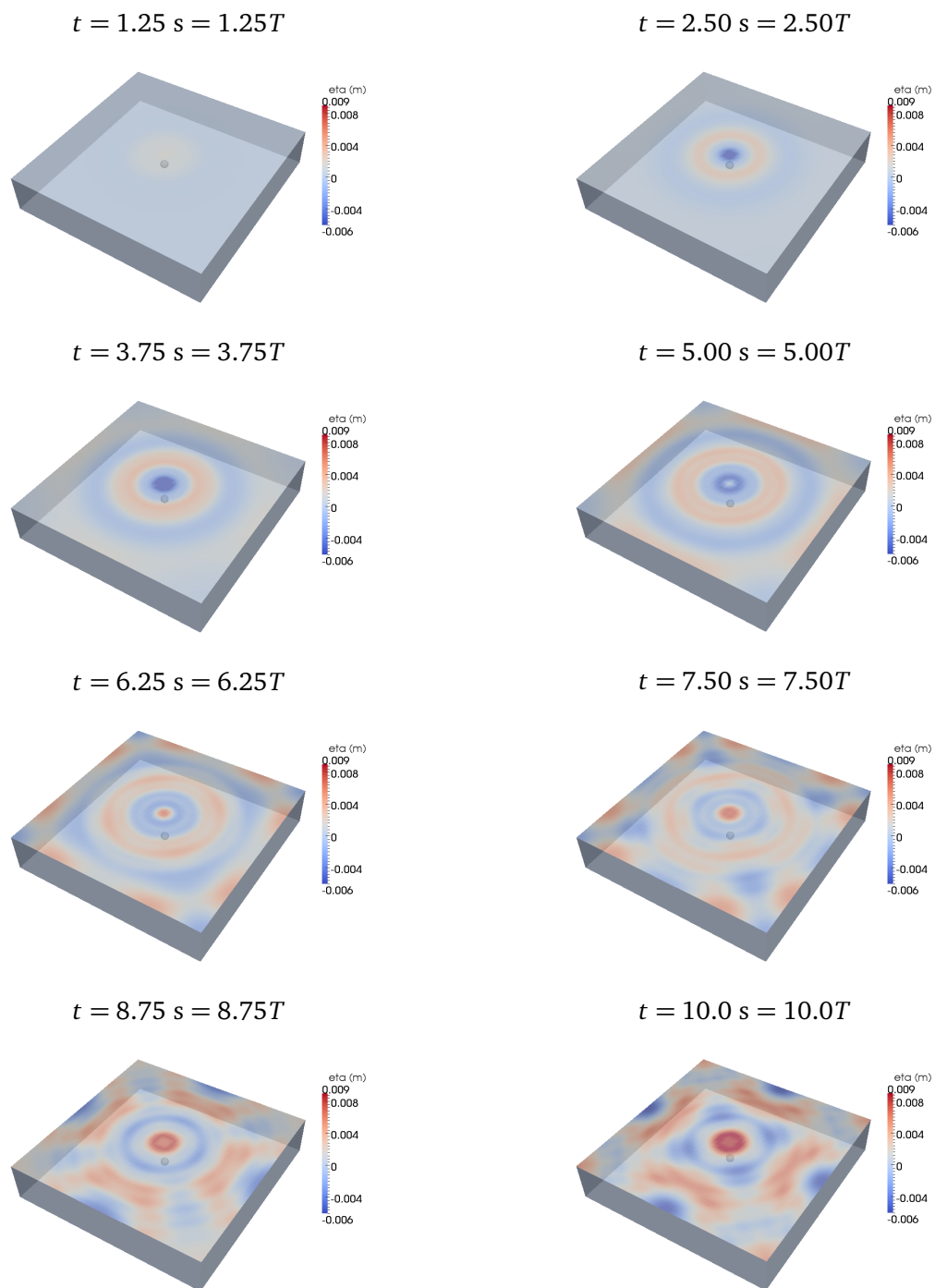

FIGURE 7.5 – Vues instantanées de la surface libre au cours du temps (lecture de gauche à droite, puis de haut en bas) pour une sphère en pilonnement forcé.

Calcul des coefficients hydrodynamiques de la sphère en pilonnement

Plusieurs simulations de cette sphère en pilonnement forcé ont aussi été réalisées dans ce même bassin, mais avec une amplitude d'oscillation volontairement très faible ($A = 10^{-8}$ m). Par une analyse de Fourier de la composante verticale des efforts hydrodynamiques, en suivant la procédure décrite au chapitre 5, section 5.3.2, les coefficients de masse ajoutée a_{zz} et d'amortissement en radiation b_{zz} en pilonnement de la sphère ont été calculés pour cinq profondeurs de son centre d'immersion : $z_c = -0.5$ m, $z_c = -0.4$ m, $z_c = -0.3$ m, $z_c = -0.2$ m et $z_c = -0.15$ m. Ces résultats sont comparés aux coefficients obtenus avec le code Aquaplus [26], fondé sur la théorie linéaire en profondeur finie, et aux coefficients calculés analytiquement par Srokosz [69], avec les hypothèses de la théorie linéaire en profondeur infinie. Ces résultats sont représentés sur la figure 7.6.

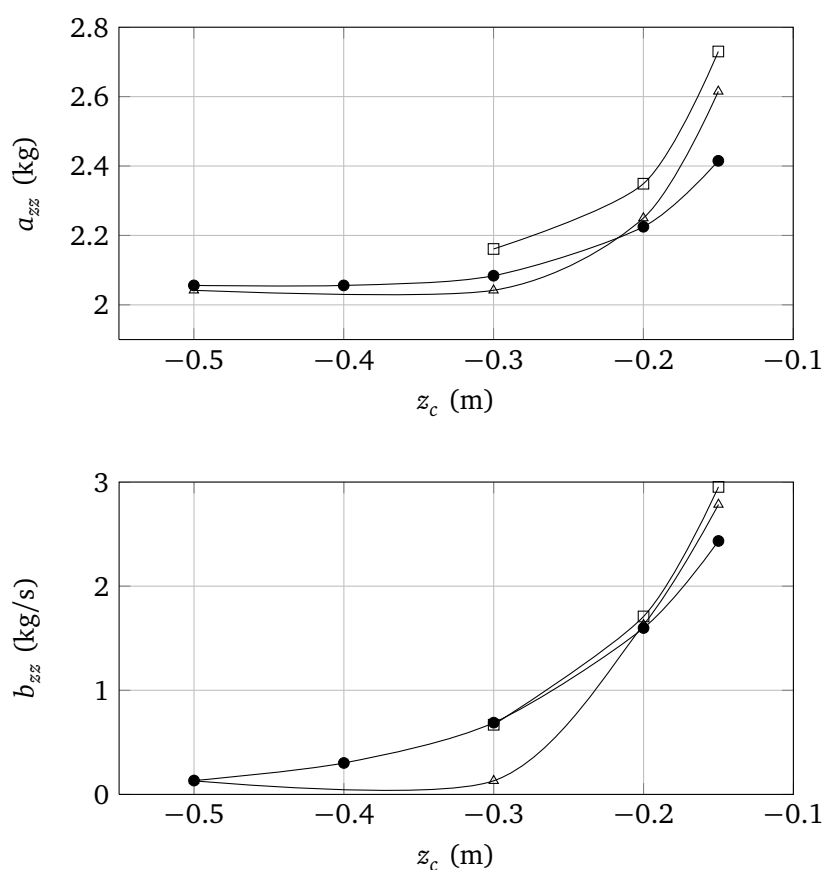

FIGURE 7.6 – Masse ajoutée (en haut) et amortissement de radiation (en bas) de la sphère en pilonnement, calculés à plusieurs profondeurs d'immersion de son centre. Les résultats obtenus avec le modèle 3D-NWT (—●—) sont comparés aux résultats numériques obtenus avec Aquaplus [26] (—△—) et aux résultats analytiques de Srokosz [69] en profondeur infinie (—□—).

Un bon accord qualitatif est observé avec une augmentation de la masse ajoutée et de l'amortissement lorsque la sphère se rapproche de la surface libre.

7.5 Mouvement libre de pilonnement de grande amplitude

On considère la même sphère, de rayon $R = 10$ cm, de flottabilité neutre (ie sa masse vaut $M = 4/3\rho\pi R^3 \approx 4.19$ kg). On fixe sa position d'équilibre à $z_{eq} = -0.5$ m = $-5R$ sous la surface libre au repos (position du centre de la sphère), au centre du même bassin de section carrée de dimensions $L_x = L_y = 5$ m = $50R$ et de hauteur d'eau au repos $h = 1$ m = $10R$.

Pour cette simulation, $M_x = M_y = 25$ éléments sont utilisés dans les deux directions horizontales et $M_z = 5$ éléments sur la verticale. La sphère est discrétisée avec 192 éléments comme au paragraphe 7.4, ce qui donne un total de 1942 éléments.

La sphère subit un effort de rappel élastique de raideur $K_z = 248.05$ N/m. A $t = 0$, elle est relâchée de sa position initiale située à 0.25 m = $2.5R$ au-dessus de la position d'équilibre du ressort. La durée de la simulation est de 10 s avec un pas de temps $\Delta t \approx 0.01$ s.

La simulation numérique montre que la sphère décrit une oscillation verticale autour de sa position d'équilibre $z_{eq} = -0.5$ m avec une période $T \approx 1$ s. La série d'images présentées sur la figure 7.7 montre l'évolution du champ de surface libre dans le canal et les interactions entre vagues générées et vagues réfléchies sur les parois. Les résultats de cette simulation sont en cours d'analyse actuellement.

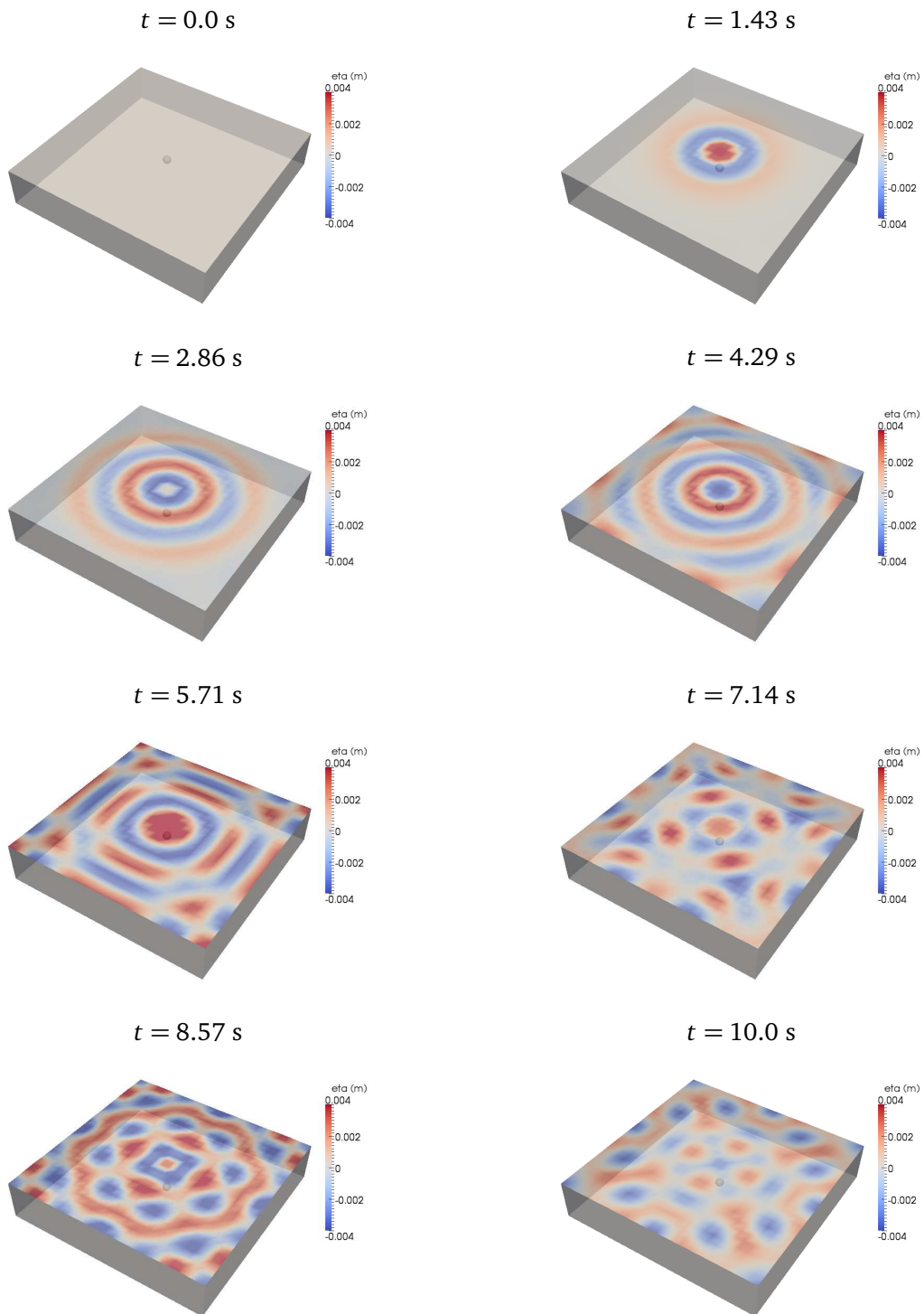

FIGURE 7.7 – Vues instantanées de la surface libre au cours du temps (lecture de gauche à droite, puis de haut en bas) pour une sphère en pilonnement libre.

7.6 Analyse des temps CPU sur les calculs 3D

Des premiers résultats de simulations ont été obtenus sur le cas d'une sphère décrivant des oscillations forcées ou libres dans un bassin de surface carrée initialement au repos. Les temps de calcul mesurés dans ces deux cas, pour deux jeux de discrétisation, sont donnés dans le tableau 7.1. Dans tous les cas, les simulations couvrent une durée de 10 s de temps réel avec un pas de temps d'environ 0.01 s. Les calculs sont effectués par un unique processeur 4 cœurs, cadencé à 2 GHz.

Nombre d'éléments quadrangulaires	$N = 2170$	$N = 6192$
cas du pilonnement forcé	11 h 31 min	4 j 22 h 19 min (cf §7.4)
cas du pilonnement libre	25 h 12 min (cf §7.5)	10 j 10 h 05 min

TABLE 7.1 – Comparaison des temps CPU requis pour des simulations 3D, pour une sphère immergée, oscillant en pilonnement libre ou forcé. Pour chaque type de mouvement, deux discrétisations sont considérées, N étant le nombre total d'éléments sur les frontières du domaine (incluant la sphère immergée).

Les calculs pour une sphère en mouvement forcé sont plus rapides que ceux pour une sphère libre, pour deux raisons principales. La première est que le couplage fluide-structure pour des corps libres, comme expliqué au chapitre 3, implique de résoudre un système plus grand pour obtenir la solution sur ϕ_t que pour un simple problème de radiation. Le nombre d'inconnues supplémentaire est égal au nombre de nœuds sur la frontière du corps. La seconde raison est qu'à chaque itération, la convergence sur les forces de pression et moments hydrodynamiques dans la boucle prédicteur-correcteur utilisée pour intégrer de façon explicite la position et vitesse du corps, est obtenue généralement en deux sous-itérations, ce qui contribue aussi à un effort CPU plus important.

7.7 Résumé et conclusions intermédiaires du chapitre

Sur le même principe que le 2DV-NWT, le 3D-NWT développé par Grilli et ses collaborateurs a été modifié pour prendre en compte une sphère immergée sous la surface libre, pouvant décrire des mouvements forcés ou libres sous l'effet de forces de rappel élastique et/ou d'amortissement linéaire, dans les trois directions de l'espace. Signalons cependant qu'un seul degré de liberté (pilonnement) a été considéré lors des premières simulations effectuées.

Bien que les temps de calcul soient conséquents, ces premiers résultats sont encourageants et montrent un bon comportement qualitatif du modèle pour les cas considérés (sphère immergée en pilonnement pur à un seul degré de liberté). En transposant ces développements

dans la version parallélisée du 3D-NWT qui utilise l'algorithme FMA (Fast Multipole Algorithm), des temps de calcul raisonnables pourront être obtenus. D'autres techniques comme la décomposition de domaines peuvent aussi être envisagées pour accélérer les simulations.

Pour des applications pratiques, l'utilisation d'éléments triangulaires sur la surface du corps semble incontournable pour décrire des géométries plus complexes.

General conclusion and outlook

8.1 Summary of conclusions from this research work

Advanced numerical models based on the Fully Nonlinear Potential Flow (FNPF) theory, referred to as two-dimensional or three-dimensional Numerical Wave Tanks (either 2DV-NWT or 3D-NWT), developed by Grilli and his collaborators along the past twenty years for simulating wave generation and absorption along an arbitrary bottom [34, 38, 37, 36], were modified and extended to take into account moving rigid submerged bodies under the free surface. The submerged bodies can be of any shape and undergo large amplitude motions, in two types of situations : forced motions and free motions. In the latter case, the body dynamics is controlled by the hydrodynamic pressure force and moment induced by waves, as well as various external forces or moments (elastic restoring force, viscous damping...). Pressure at the body boundary is obtained as a result of the dynamic equilibrium between the fluid and body at the body boundary, expressed by an integral equation, originally derived by Van Daa-len [78] and Tanizawa [72]. Such a method guarantees the dynamic equilibrium of waves and bodies in the time marching scheme. The mathematical formulation of this coupling algorithm was treated in chapter 2.

In chapter 3, the numerical implementation of the coupled modelling was presented. The High-Order Boundary Element Method (HOBEM), used to solve two Laplace equations for the velocity potential and its time derivative, was briefly recalled. At the end of every iteration, kinematic and dynamic free surface boundary conditions are explicitly marched in time with two second-order Taylor series expansions, while an implicit Newmark scheme of parameter $\beta = 1/2$ and $\gamma = 1/4$, also called the average acceleration method, was implemented to update the position and velocity of the body. A predictor-corrector loop was also implemented for the hydrodynamic pressure force and moment to converge to their values at the next iteration, in order to obtain the accelerations of the body center of mass required in the Newmark scheme.

Numerical applications and validations for various cases were presented in chapters 4 and 5. The accuracy of the model in conserving fluid volume and total energy in the computational domain was checked for a circular cylinder in forced and free heaving oscillations, submerged under a free surface initially at rest, in a narrow tank with lateral reflective walls. Very accurate results were obtained by refining the free surface mesh, with relative errors on fluid volume and total mechanical energy of $O(10^{-5})$ and $O(10^{-4})$ respectively, over about 40 periods of cylinder oscillations. Other validations were performed by comparing the numerical results with experimental or analytical results based on the linear wave theory, for a forced motion of

a submerged circular cylinder. A practical application of the submerged circular cylinder as a Wave Energy Converter (WEC), was treated analytically by Evans [27] and Evans et al. [28] (known as the “Bristol Cylinder”). These linear predictions were compared to our numerical simulations, with a good agreement for waves of low steepness. Nonlinear effects on the trajectory and efficiency of the device were analyzed by gradually increasing wave steepness. A drop in the efficiency was observed when increasing wave steepness, a result confirmed by Evans et al. experimental data [28].

We also performed our own experimental tests in the wave tank of University of Rhode Island in collaboration with Pr. Stephan Grilli and some of his collaborators and students, for a circular cylinder device linked to the bottom with a linear power take-off system. The device configuration was presented, along with results for regular waves. The numerical model was adapted to add a drag force into the body dynamics, using the well-known Morison formulation. The drag coefficient needed however to be increased up to a value of $C_d = 5$ so that numerical and experimental results get closer. Resonance period of the device was not included in the range of the tested wave periods.

In chapter 6, numerical simulations were performed in irregular waves generated by a flap type wavemaker. The influence of the spectral bandwidth of the generated sea states, corresponding to JONSWAP spectra with different values of the peak enhancement factor γ from 1 to 20, was studied on the efficiency of the Bristol Cylinder. Simulations with two identical circular cylinders harnessing incident wave energy were also performed. We observed the influence of the separation distance on the total absorbed power, and on the efficiency of each cylinder. No constructive interaction was observed in the simulated 2DV case.

Finally in chapter 7, preliminary three-dimensional simulations were performed for the case of a rigid submerged sphere, integrated in the 3D-NWT [36]. Similarly to the two-dimensional model, the sphere can describe forced motion, or free motion under wave action and other external forces. Preliminary results are shown, for a sphere in a forced heaving oscillation in a square tank with lateral reflective walls, and for a sphere linked to the seabed by an elastic restoring force. This first series of runs of the 3D model has allowed to estimate computer resources (CPU times) for real case applications in 3D, and confirms the need to optimize the computational aspects of the code in the future.

8.2 Outlook for future research and development

Several improvements of the present numerical models could be achievable at short or mid term, which would lead to new ways for future research and applications, in the wide field of offshore structures. The main research axes are briefly outlined below.

1. Experimental validation in nonlinear sea states : The two-dimensional model has shown a very good accuracy when comparing its results with predictions from the linear wave theory, for small steepness and small amplitude of body motion. However, due to the lack of available data in the literature regarding the interactions of nonlinear waves with totally submerged structures, the model could not be further validated for large amplitude motion under the action of steep sea states. Performing other tank measurements with our experimental device (see section 5.4), especially for a wider range of incident wave periods and larger wave heights, could contribute to a more comprehensive validation of our nonlinear model. Note that regarding the design of an experimental device, a special care should be taken in the future for the choice of the power take-off mechanism and/or the submergence depth of the

cylinder, so that the body displacement is not restrained in its magnitude by the maximum displacement of the magnet of the electrical linear generator.

2. Extension to floating bodies with complex geometries : Developments in the numerical treatment of the free surface could allow to simulate floating bodies as well, for which more experimental data are available in the literature. These developments would also require an accurate computation of the intersection point (in 2DV) or intersection line (in 3D), between the free surface and the body boundary, already treated by several authors (see e.g. [73]) with the double node technique. Furthermore, implementing triangular elements for the body surface discretization would also make the simulation of more complex three-dimensional geometries possible. Beyond the field of Wave Energy Converters, many other applications, such as floating offshore wind turbines, could be considered in this regard. In the context of offshore wind turbines, during his master thesis research project in our laboratory, Yann Chachereau performed some preliminary numerical tests on a horizontal cylinder of rectangular cross-section submitted to incident regular waves [18]. He obtained a fair agreement between our 2D nonlinear model and the 3D linear model Aquaplus [26], developed by Ecole Centrale de Nantes. In order to draw comparable results, the length of the 3D cylinder in Aquaplus was adjusted to simulate a 2D behaviour. A detailed report of his work is available in [18].

3. Improvement of CPU effort for 3D computations : Three dimensional simulations are obviously very time consuming when run on a single processor. Using the Fast Multipole Algorithm (FMA) in the spatial solver would reduce the computational complexity from $O(N^2)$ to $O(N \log N)$, with N the total number of nodes on the domain boundaries. There exists such a 3D wave model based on the FMA (see [37]), which was not used in the present preliminary 3D tests for simplicity reasons, but into which could our developments be transposed. Another technique called the Image Method and mentioned in Grilli et al. [36], useful for applications with a flat bottom, would remove parts of the discretization by taking advantage of the symmetry with respect to the plane $z = -h$. The domain decomposition method is another technique which divides the domain into adjacent sub-domains with specific boundary conditions between them. The global influence matrix becomes block-diagonal instead of full and non-symmetric for a single domain, and linear systems are faster solved. The improvement in CPU effort brought by these various techniques would be a major step towards real 3D applications.

4. Nonlinear anchoring/mooring systems : The present research only considered linear anchoring systems, simply modeled by a linear spring and damper. However, there is no major obstacle to add nonlinear restoring or damping forces into the body dynamics, such as a force proportional to the square displacement or square velocity of the center of mass for instance. Some simple modifications of the time integration of the body dynamics would only be required : instead of reaching convergence of the hydrodynamic pressure force and moments using a predictor-corrector loop, convergence would be searched for the total nonlinear part of the forces, including the pressure force and the external forces. This method, classically met in solid mechanics, was not tried when implementing the Morison formulation, which was simply linearized. Other devices, anchored by more complex systems, could then be modelled. Also, control strategies to increase the power harnessed by the WEC, such as the latching control approach for instance [7], could be implemented and tested in the model, as it is a time-domain model.

5. Ambient current effects : The present modelling approach did not consider any effect of ambient currents (due to e.g. tides). Inclusion of current in the model is however possible as long as the flow field remains irrotational. This extension would be of high interest for studying dynamics of WECs under the combined action of surface waves and ambient currents.

6. Improvement of viscous effects representation : Comparisons of our numerical results with experimental tests have shown a significant influence of viscous damping. These effects could be better modeled in our numerical model either by working on the calibration of the Morison formulation, or possibly, although much more demanding, by considering a local coupling with a CFD model, solving RANS equations around the body.

7. Study of trapped modes and their sensitivity to wave height : The existence of “Trapped modes” was outlined and studied by Evans and Porter [29] through a linear analytical approach. Our numerical model could be used to study these trapped modes in more real configurations, and to investigate their sensitivity to e.g. wave height and nonlinear effects. A better understanding and a quantitative analysis of trapped modes for bodies in one single degree of freedom, and the apparition of coupled modes for bodies in two or three degrees of freedom is a potential research axis for the future.

Table des figures

1.1	CETO commercial scale unit, source : www.carnegiewave.com	2
1.2	Illustration of the diffraction problem : physical interactions between incident waves and a fixed body. Depending on the shape of the body and the nature of incident waves, these can be altered by the structure, resulting in modified transmitted waves. Reflected waves may also interact with incident waves (if nonlinear effects are accounted for).	3
1.3	Illustration of the radiation problem : physical interactions between a heaving body and the radiated waves. The body is submitted to the radiation forces, due to waves created by its own motion.	4
1.4	Illustration of the physical interactions in wave diffraction (blue) and radiation (red) by a heaving body under incident waves. Two wave-wave interactions between radiated waves and both incident and transmitted waves have to be taken into account.	5
2.1	Scheme of the considered situation, here in 2DV : a totally submerged and rigid body, moving under the action of ocean waves and various external forces. . . .	10
2.2	A two-dimensional submerged circular cylinder interacting with incident monochromatic waves, and physical variables used to describe the fluid, waves, cylinder and anchoring system.	12
2.3	Kc is the ratio of the amplitude a of the orbital motion to the diameter $2R$ of the cylinder (from [71]).	14
2.4	Regimes of flow around a circular cylinder in oscillatory flow for small Kc numbers ($Kc < 3$) (Sumer and Fredsøe, [71]). Circles are obtained from Sarpkaya's experiments [66] ; crosses for $Re < 1000$ from Honji [48] and crosses for $Re > 1000$ from Sarpkaya [66]. This diagram is taken from Sumer and Fredsøe [71], who previously adapted it from Sarpkaya [66].	15
2.5	Sketch of computational domain Ω of 2DV-NWT, and its boundaries Γ_f , Γ_{r1} , Γ_{r2} , Γ_b and Γ_c	16
2.6	Definition of mathematical symbols used to describe the two-dimensional rigid body boundary Γ_c submerged under the free surface Γ_f	18
2.7	Definition of mathematical symbols used to describe the three-dimensional rigid body boundary Γ_c submerged under the free surface Γ_f	18
3.1	Time-integration of free-surface boundary $\Gamma_f(t)$ (position of nodes \mathbf{r} and free-surface velocity potential ϕ) and body boundary $\Gamma_c(t)$ (center of mass position \mathbf{x} and velocity $\dot{\mathbf{x}}$, as well as angular position θ and velocity $\dot{\theta}$).	30

4.1	Sketch of problem geometry for a cylinder of radius $R = 0.1$ m in forced heaving motion of amplitude $A = R$ and period T , in water of depth $h = 1$ m.	36
4.2	Case of Fig. 4.1. Non-dimensional free surface elevation (with respect to the amplitude of oscillation A of the cylinder) as a function of non-dimensional time, computed at numerical gages located at $x_g = 2\lambda/3$ (—) and $4\lambda/3$ (.....) from the cylinder, for two submergence depths z_0 of the cylinder : (a) -0.5 m ; (b) -0.4 m. The forced heave amplitude is $A = 0.1$ m and period $T = 0.5$ s. . . .	37
4.3	Case of Fig. 4.1. Mean volume error after 40 periods of heave oscillation, for $T = 0.5$ s and $T = 0.8$ s and two cylinder submergence depths, as a function of the nondimensional discretization step $1/N_f = \Delta x/\lambda$	38
4.4	Case of Fig. 4.1. Error on volume conservation in the computational domain Ω , for two cylinder submergence depths z_0 and two periods of oscillation T . For each case, results for four spatial free surface discretization steps $\Delta x = \lambda/N_f$ are plotted : $N_f = 15$ (.....), $N_f = 25$ (---), $N_f = 50$ (.....), $N_f = 75$ (—). . . .	39
4.5	Adimensioned Mean Vertical Force - NWT results (—◆—) compared to Chaplin's (1984) experiments (○) and to 2 nd order theory of Ogilvie (1963) (—).	41
4.6	1 st harmonic of the horizontal (—◆—) and vertical force (—◇—) compared to Chaplin's (1984) experiments (○), linear theory of Ogilvie (1963) (—) and viscous simulations of Tavassoli and Kim (2001) (■).	41
4.7	2 nd (—◇—) and 3 rd (—◆—) harmonics of the adimensioned vertical force compared to Chaplin's (1984) experiments (○) and viscous simulations of Tavassoli and Kim (2001) (■).	42
4.8	Forced heaving motion of a cylinder of radius $R = 0.1$ m in depth $h = 3$ m. Successive snapshots of waves generated at $t/T = 2.75, 2.99, 3.10$ for an amplitude $A/R = 1.75$, and $kR = 0.1$ (period $T = 2.01$ s).	43
4.9	Nondimensional Mean vertical force results computed by BEM for $kR = 0.1$ (—◇—) and $kR = 1$ (—◆—), compared to Wu's linear theory (—○—, —●—) for various amplitudes of body motion.	44
4.10	1 st harmonic of the vertical force results computed by BEM for $kR = 0.1$ (—◇—) and $kR = 1$ (—◆—), compared to Wu's linear theory (—○—, —●—) for various amplitudes of body motion.	45
4.11	2 nd harmonic of the vertical force results computed by BEM for $kR = 0.1$ (—◇—) and $kR = 1$ (—◆—), compared to Wu's linear theory (—○—, —●—) for various amplitudes of body motion.	45
4.12	Successive snapshots ($t/T = 4.40, t/T = 4.49, t/T = 4.62$) of waves generated by the clockwise circular motion of a cylinder ($A/R = 1.75, kR = 0.5$).	46
4.13	Vertical (—) and horizontal (.....) hydrodynamic forces exerted on the cylinder - $kR = 0.5$ and $A/R = 1.75$	47
4.14	Mean non-dimensional vertical (—◆—) and horizontal (—◇—) forces with $kR = 0.5$, compared to Wu's (1993) analytical theory (—●—, —○—).	47
4.15	1 st harmonic amplitude of the non-dimensional vertical (—◆—) and horizontal (—◇—) forces with $kR = 0.5$, compared to Wu's (1993) analytical theory (—●—, —○—).	48
4.16	2 nd harmonic amplitude of the non-dimensional vertical (—◆—) and horizontal (—◇—) forces with $kR = 0.5$, compared to Wu's (1993) analytical theory (—●—, —○—).	48

5.1	Sketch of problem geometry for a freely heaving cylinder of radius $R = 0.1$ m, following an initial vertical displacement $A = R$, in water of depth $h = 1$ m. The cylinder is anchored to the bottom of the tank by a spring of stiffness K_0	52
5.2	For submergence depth $z_{eq} = -0.4$ m, from top to bottom, non-dimensional vertical position of the cylinder from equilibrium depth, fluid and cylinder mechanical energy variations, work done by the fluid on the cylinder, error in energy conservation of the total system {fluid + cylinder}, as a function of non-dimensional time t/T	55
5.3	For submergence depth $z_{eq} = -0.3$ m, from top to bottom, non-dimensional vertical position of the cylinder from equilibrium depth, fluid and cylinder mechanical energy variations, work done by the fluid on the cylinder, error in energy conservation of the total system {fluid + cylinder}, as a function of non-dimensional time t/T	56
5.4	Case of Fig. 5.1, for submergence depth $z_{eq} = -0.4$ m. Time series of the number N_i of sub-iterations required to achieve convergence of the body hydrodynamic pressure force, and relative error $\epsilon_{\mathcal{F}}$ on the latter at convergence; the 10^{-6} convergence threshold is marked on the figure (---).	57
5.5	Case of Fig. 5.1, for submergence depth $z_{eq} = -0.3$ m. Time series of the number N_i of sub-iterations required to achieve convergence of the body hydrodynamic pressure force, and relative error $\epsilon_{\mathcal{F}}$ on the latter at convergence; the 10^{-6} convergence threshold is marked on the figure (---).	58
5.6	Case of Fig. 5.1, for submergence depth $z_{eq} = -0.4$ m. Time series of mean energy and volume conservation errors ($T = 0.8$ s). Numerical results are shown for four spatial discretization steps on the free surface boundary with : $N_f = \lambda/\Delta x = 15$ (.....), $N_f = 25$ (---), $N_f = 50$ (.....), $N_f = 75$ (—).	59
5.7	Case of Fig. 5.1, for submergence depth $z_{eq} = -0.3$ m. Time series of mean energy and volume conservation errors ($T = 0.8$ s). Numerical results are shown for four spatial discretization steps on the free surface boundary with : $N_f = \lambda/\Delta x = 15$ (.....), $N_f = 25$ (---), $N_f = 50$ (.....), $N_f = 75$ (—).	60
5.8	Sketch of problem geometry : the tuned Bristol cylinder device is submitted to regular waves of pulsation ω and amplitude A in a flume of depth h . An absorbing beach is set at the end of the tank over a length of four times the wavelength.	64
5.9	Non-dimensional linear added-mass of the cylinder in sway (\ominus) and heave (\blacktriangleleft) computed by BEM, as compared to Frank's linear results [31] (---), and Benoit's computations (—) based on the linear analytical approach by Evans and Porter [29].	67
5.10	Non-dimensional linear radiative damping of the cylinder in sway (\ominus) and heave (\blacktriangleleft) computed by BEM, as compared to Frank's linear results [31] (---), and Benoit's computations (—) based on the linear analytical approach by Evans and Porter [29].	67
5.11	Mean value and amplitude of the first harmonic of the horizontal (left) and vertical (right) non-dimensional exciting forces as a function of kR , for incident waves of various steepnesses : $H/\lambda = 0.05\%$ (\ominus), 0.10% (\bullet), 0.20% (\boxplus), 0.50% (\blacktriangleleft), 1.00% (\blacklozenge), compared to Evans linear prediction (—).	69

5.12	Amplitudes of the second and third harmonics of the horizontal (left) and vertical (right) non-dimensional exciting forces as a function of kR , for incident waves of various steepnesses : $H/\lambda = 0.05\%$ (\ominus), 0.10% (\ominus), 0.20% (\ominus), 0.50% (\ominus), 1.00% (\ominus), compared to Evans linear prediction (—).	70
5.13	Non-dimensional horizontal and vertical forces for $\omega = 10$ rad/s ($kR = 0.51$) and for incident waves of various steepnesses : $H/\lambda = 0.05\%$ (—), 0.10% (---), 0.20% (-----), 0.50% (.....), 1.00% (---).	71
5.14	Mean value and amplitude of the first harmonic of the horizontal (left) and vertical (right) non-dimensional total forces as a function of kR , for incident waves of various steepnesses : $H/\lambda = 0.05\%$ (\ominus), 0.10% (\ominus), 0.20% (\ominus), 0.50% (\ominus), 1.00% (\ominus), compared to Evans linear prediction (—).	72
5.15	Amplitudes of the second and third harmonics of the horizontal (left) and vertical (right) non-dimensional total forces as a function of kR , for incident waves of various steepnesses : $H/\lambda = 0.05\%$ (\ominus), 0.10% (\ominus), 0.20% (\ominus), 0.50% (\ominus), 1.00% (\ominus), compared to Evans linear prediction (—).	73
5.16	Trajectory of the center of mass for $\omega = \omega_0 = 10$ rad/s ($kR = 0.51$), for incident waves of various steepnesses : $H/\lambda = 0.05\%$ (---), 0.10% (-----), 0.20% (.....), 0.50% (---), 1.00% (---), compared to Evans linear circular path (—).	74
5.17	Mean value and amplitude of the first order harmonic of the horizontal (left) and vertical (right) non-dimensional displacement of the center of mass as a function of kR , for incident waves of various steepnesses : $H/\lambda = 0.05\%$ (\ominus), 0.10% (\ominus), 0.20% (\ominus), 0.50% (\ominus), 1.00% (\ominus), compared to Evans linear prediction (—).	75
5.18	Amplitudes of the second and third order harmonics of the horizontal (left) and vertical (right) non-dimensional displacement of the center of mass as a function of kR , for incident waves of various steepnesses : $H/\lambda = 0.05\%$ (\ominus), 0.10% (\ominus), 0.20% (\ominus), 0.50% (\ominus), 1.00% (\ominus), compared to Evans linear prediction (—).	76
5.19	Élévation de la surface libre adimensionnées, à $t = 8$ s, pour des vagues à la fréquence de réglage du système, et pour l'ensemble des cambrures considérées : $H/\lambda = 0.05\%$ (—), $H/\lambda = 0.10\%$ (---), $H/\lambda = 0.20\%$ (-----), $H/\lambda = 0.50\%$ (.....), $H/\lambda = 1.00\%$ (---). Le cylindre se trouve à l'abscisse $x = 0.92$ m (en moyenne).	77
5.20	Efficacité du cylindre de Bristol en fonction de kR pour les cambrures $H/\lambda = 0.05\%$ (\ominus), $H/\lambda = 0.10\%$ (\ominus), $H/\lambda = 0.20\%$ (\ominus), $H/\lambda = 0.50\%$ (\ominus), $H/\lambda = 1.00\%$ (\ominus). La théorie linéaire d'Evans correspond à la courbe en trait plein.	78
5.21	Efficacité du cylindre de Bristol en fonction de la cambrure des vagues incidentes, mesurée expérimentalement par Evans [28] (pour un cylindre réglé à $kR = 0.55$), pour 3 fréquences : $kR = 0.55$ (\ominus), $kR = 0.40$ (\ominus) et $kR = 0.27$ (\ominus). Nos résultats de simulations pour le même cylindre mais réglé à $kR = 0.51$ sont également représentés aux fréquences $kR = 0.51$ (\ominus), $kR = 0.41$ (\ominus) et $kR = 0.33$ (\ominus).	78
5.22	Canal à houle de l'Université du Rhode Island. Le batteur est situé côté droit de la photographie.	80

5.23	Profil bathymétrique du canal mesuré (—) et profil utilisé dans les simulations numériques (.....). Trois sondes s_1 , s_2 et s_3 sont placées dans le canal pour mesurer le profil de surface libre en amont et en aval du système.	81
5.24	Caractéristiques et dimensions du système houlomoteur.	82
5.25	Le système mis à l'eau avant les essais. On distingue au centre du cylindre le générateur et le système de guidage des fils électriques, et de chaque côté les deux ressorts latéraux surmontés des boîtiers contenant les accéléromètres. . . .	83
5.26	A gauche : le générateur linéaire ancré par une plateforme circulaire au fond du bassin. A droite : le système de guidage étanche des fils électriques.	83
5.27	A gauche : une extrémité du cylindre au repos, située à quelques centimètres de la paroi du canal. On distingue les lignes d'ancrage. A droite : un des deux boîtiers étanches contenant un accéléromètre.	83
5.28	Bilan des efforts exercés sur le cylindre : le poids Mg , les efforts de pression hydrodynamique F_h , les efforts F_r dans la direction radiale et la traînée visqueuse F_v	84
5.29	Régimes de l'écoulement autour d'un cylindre circulaire lisse dans un écoulement oscillant à faible Kc ($Kc < 3$). Sur cette figure, (a) : pas de détachement tourbillonnaire, écoulement rampant ; (a') : pas de détachement, couche limite turbulente ; (b) : détachement de vortex de Honji ; (c) : paire de vortex symétriques ; (d) : paire de vortex symétriques et turbulence à la surface du cylindre. Cette figure est issue de Sumer et Fredsoe [71], qui utilise les données de Sarpkaya [66] et de Honji [48].	88
5.30	De haut en bas : élévations de surface libre enregistrées par les trois sondes s_1 , s_2 , s_3 disposées dans le canal (voir Fig. 5.23 pour la position relative des sondes), composante radiale de l'accélération du cylindre enregistrées par chacun des deux accéléromètres, puissance électrique mesurée.	90
5.31	Amplitude du mouvement radial adimensionné par l'amplitude des vagues incidentes pour les différentes périodes générées. Les résultats des essais (\times) sont comparés aux résultats des simulations numériques pour plusieurs coefficients de traînée C_d du cylindre.	91
5.32	Efficacité électrique du système houlomoteur en fonction de la période des vagues incidentes. Les résultats des essais (\times) sont comparés aux résultats des simulations numériques pour plusieurs coefficients de traînée C_d du cylindre. . .	91
6.1	Correspondance entre la hauteur de houle H_r en vagues régulières et la hauteur significative H_{m_0} en vagues irrégulières en fonction de γ , pour $f_p = f_r = f_0 = 1.65$ Hz, d'après la théorie linéaire en profondeur finie.	96
6.2	Spectres de JONSWAP ($f_p = 1.65$ Hz) pour $H_r = 1$ cm et 4 valeurs de γ , tronqués sur l'intervalle $[f_{min}f_{max}]$	96
6.3	En haut : élévation de surface libre η à l'abscisse moyenne du cylindre. En bas : flux incident Φ_i et puissance absorbée \mathcal{P}_{abs} , pour $H_r = 0.1$ mm et $\gamma = 1$	97
6.4	En haut : élévation de surface libre η à l'abscisse moyenne du cylindre. En bas : flux incident Φ_i et puissance absorbée \mathcal{P}_{abs} , pour $H_r = 0.1$ mm et $\gamma = 20$	98
6.5	Efficacité du cylindre de Bristol en fonction du facteur d'étalement spectral γ en vagues irrégulières, pour 3 hauteurs de vagues régulières équivalentes : $H_r = 0.1$ mm (\ominus), 1.0 mm (\star) et 1.0 cm (\blacktriangle).	98

6.6	Géométrie du canal à houle considéré, positions des deux cylindres et de la sonde s_1 . 16 cas sont considérés avec un écartement adimensionné d/λ_p variant de 0.1 à 4.	101
6.7	Pour $d/\lambda_p = 0.1$, spectres de variance mesurés par les trois sondes s_1 (—), s_2 (----) et s_3 (.....), comparés au spectre cible (—).	102
6.8	Pour $d/\lambda_p = 1$, spectres de variance mesurés par les trois sondes s_1 (—), s_2 (----) et s_3 (.....), comparés au spectre cible (—).	103
6.9	Pour $d/\lambda_p = 4$, spectres de variance mesurés par les trois sondes s_1 (—), s_2 (----) et s_3 (.....), comparés au spectre cible (—).	103
6.10	Puissance absorbée instantanée par les cylindres amont (—) et aval (—), pour $d/\lambda_p = 0.1$ (en haut), $d/\lambda_p = 1$ (au milieu) et $d/\lambda_p = 1$ (en bas).	104
6.11	Efficacité E_1 du cylindre amont (—●) et E_2 du cylindre aval (—●) en fonction de l'écartement adimensionné d/λ_p , comparé à l'efficacité E_0 d'un cylindre seul (—).	105
6.12	Facteur q en fonction de l'écartement adimensionné d/λ_p	106
7.1	Schéma du bassin à houle 3D et des différentes frontières.	108
7.2	Principe de la pixelisation HEALPix (image tirée de [1]).	109
7.3	Maillage HEALPIX de la sphère avec 192 quadrilatères pour 194 nœuds. En rouge : 2 nœuds à l'intersection de 3 arêtes qui perturbent la construction de l'élément glissant 4×4 nœuds (en noir).	109
7.4	En haut : déplacement vertical imposé du centre de la sphère. En bas : composante verticale de la force de pression hydrodynamique totale sur la sphère (qui inclut la poussée d'Archimède, constante, $4/3\rho g\pi R^3 \approx 41.1$ N).	111
7.5	Vues instantanées de la surface libre au cours du temps (lecture de gauche à droite, puis de haut en bas) pour une sphère en pilonnement forcé.	112
7.6	Masse ajoutée (en haut) et amortissement de radiation (en bas) de la sphère en pilonnement, calculés à plusieurs profondeurs d'immersion de son centre. Les résultats obtenus avec le modèle 3D-NWT (—●) sont comparés aux résultats numériques obtenus avec Aquaplan [26] (—▲) et aux résultats analytiques de Srokosz [69] en profondeur infinie (—□).	113
7.7	Vues instantanées de la surface libre au cours du temps (lecture de gauche à droite, puis de haut en bas) pour une sphère en pilonnement libre.	115

Bibliographie

- [1] Healpix home page <http://healpix.jpl.nasa.gov/>.
- [2] WAMIT project home page <http://www.wamit.com/>.
- [3] ADEME. *Feuille de route sur les énergies renouvelables marines*, 2009.
- [4] W. T. Ang. *A Beginner's Course in Boundary Element Method*. Universal Publishers, 2007.
- [5] R. R. Azcueta. *Computation of Turbulent Free-Surface Flows around Ships and Floating Bodies*. PhD thesis, Technischen Universität Hamburg-Harburg, Germany, 2001.
- [6] A. Babarit. Impact of long separating distances on the energy production of two interacting wave energy converters. *Ocean Engineering*, 37 :718–729, 2010.
- [7] A. Babarit, G. Duclos, and A. H. Clément. Comparison of latching control strategies for a heaving wave energy device in random sea. *Applied Ocean Research*, 16 :227–238, 2004.
- [8] W. Bai and R. Eatock-Taylor. Numerical simulation of fully nonlinear regular and focused wave diffraction around a vertical cylinder using domain decomposition. *Applied Ocean Research*, 29 :55–71, 2007.
- [9] W. Bai and R. Eatock-Taylor. Fully nonlinear simulation of wave interaction with fixed and floating flared structures. *Ocean Engineering*, 36 :223–236, 2009.
- [10] C. Berhault, P. L. Buhon, B. Molin, and J. Bougis. Diodore : a numerical tool for frequency and time domain analysis of the behaviour of moored or towed floating structures. In *Proceedings of the 4th International Conference on Computer Aided Design Manufacture and Operation in the Marine and Offshore Industries (CADMO)*, 1992.
- [11] P. J. F. Berkvens. *Floating bodies interacting with water waves*. PhD thesis, Universiteit Twente, The Netherlands, 1998.
- [12] M. Bonnet. *Équations intégrales et éléments de frontières : Applications en mécanique des solides et des fluides (in French)*. Sciences et Techniques de l'ingénieur. CNRS Editions/Editions Eyrolles, 1995.
- [13] B. Borgarino. *Résolution accélérée du problème de tenue à la mer appliquée à l'étude paramétrique de fermes de récupérateurs de l'énergie des vagues (in French)*. PhD thesis, Ecole Centrale de Nantes, France, 2011.
- [14] B. Borgarino, A. Babarit, and P. Ferrant. Implémentation d'une méthode multipole rapide dans le code de diffraction/radiation Aquaplan pour la simulation de fermes de récupérateurs d'énergie des vagues (in French). In *12^{èmes} Journées de l'Hydrodynamique*, 2010.
- [15] C. A. Brebbia and J. Dominguez. *Boundary Element Methods : An Introductory Course (2nd edition)*. WIT Press, 1992.
- [16] R. Caljouw, D. Harrowfield, L. D. Mann, and J. Fievez. Testing and model evaluation of a scale CETO unit. towards the deployment of a commercial scale CETO Wave Energy

- Converter. In *Proceedings of the 9th European Wave and Tidal Energy Conference (EWTEC)*, 2011.
- [17] Y. Cao, R. F. Beck, and W. W. Schultz. Nonlinear computation of wave loads and motions of floating bodies in incident waves. In *Proceedings of the 9th International Workshop on Water Waves and Floating Bodies (IWWF)*, 1994.
- [18] Y. Chachereau. Hydrodynamics of offshore floating wind turbines, development of a model using a fully nonlinear potential theory, Master Thesis report, Saint-Venant Laboratory for Hydraulics, Chatou (France), 2011.
- [19] J. F. Chaplin. Nonlinear forces on a horizontal cylinder beneath waves. *Journal of Fluid Mechanics*, 147 :449–464, 1984.
- [20] A. H. Clément. Coupling of two absorbing boundary conditions for 2D time-domain simulations of free surface gravity waves. *Journal of Computational Physics*, 126(1) :139–151, 1996.
- [21] A. H. Clément. Using differential properties of the green function in seakeeping computational codes. In *Proceedings of the 7th International Conference on Numerical Ship Hydrodynamics*, volume 6, pages 1–15, 1999.
- [22] R. Cointe. *Quelques aspects de la simulation numérique d'un canal à houle (284 pages in French)*. PhD thesis, Ecole Nationale des Ponts et Chaussées, Paris, France, 1989.
- [23] J. Cruz. *Ocean Wave Energy : current status and future perspectives*, volume 12 of *Green Energy and Technology*. Springer, 2008.
- [24] W. R. Dean. On the reflexion of surface waves by a submerged circular cylinder. *Mathematical Proceedings of the Cambridge Philosophical Society*, 44(4) :483–491, 1948.
- [25] W. R. Dean and R. A. Dalrymple. *Water wave mechanics for engineers and scientists*, World Scientific. 1991.
- [26] G. Delhommeau. Seakeeping codes Aquadyn and Aquaplus. In *19th WEGMENT School, Numerical Simulation of Hydrodynamics : Ship and Offshore Structures*, 1993.
- [27] D. V. Evans. A theory for wave-power absorption by oscillating bodies. *Journal of Fluid Mechanics*, 77(1) :1–25, 1976.
- [28] D. V. Evans, D. C. Jeffrey, S. H. Salter, and J. R. M. Taylor. Submerged cylinder wave energy device : theory and experiment. *Applied Ocean Research*, 1(1) :3–12, 1979.
- [29] D. V. Evans and R. Porter. Wave-free motions of isolated bodies and the existence of motion trapped modes. *Journal of Fluid Mechanics*, 584 :225–234, 2007.
- [30] P. Ferrant. Runup on a cylinder due to waves and current : potential flow solution with fully nonlinear boundary conditions. In *Proceedings of the 8th International Offshore and Polar Engineering Conference (ISOPE)*, 1998.
- [31] W. Frank. Oscillation of cylinders in or below the free surface of deeps fluids. *Report of the Naval Ship Research and Development Center*, R-2375 :1–40, 1967.
- [32] L. Gentaz, R. Luquet, B. Alessandrini, and P. Ferrant. Numerical simulation of the 3D viscous flow around a vertical cylinder in non-linear waves using an explicit incident wave model. In *Proceedings of the 24th International Offshore and Polar Engineering Conference (ISOPE)*, 2004.
- [33] N. Greene. Irregular wave generation in a fully nonlinear potential flow numerical wave tank, Master Thesis report, Ocean Engineering Department, University of Rhode Island (USA), 2009.

-
- [34] S. T. Grilli. Fully nonlinear potential flow models used for long wave runup prediction. In H. Yeh, P. Liu, and C. Synolakis, editors, *Long-Wave Runup Models*, pages 116–180. World Scientific Publishing, 1997.
- [35] S. T. Grilli. Lecture on the boundary element method. Private lecture given at Laboratory St-Venant for Hydraulics, Chatou (France), December 2010.
- [36] S. T. Grilli, F. Dias, P. Guyenne, C. Fochesato, and F. Enet. *Progress in fully nonlinear potential flow modeling of 3D extreme ocean waves*, chapter 3, pages 75–128. World Scientific Publishing, 2010.
- [37] S. T. Grilli, P. Guyenne, and F. Dias. A fully nonlinear model for 3D overturning waves over an arbitrary bottom. *International Journal for Numerical Methods in Fluids*, 35 :829–867, 2001.
- [38] S. T. Grilli and J. Horrillo. Numerical generation and absorption of fully nonlinear periodic waves. *Journal of Engineering Mechanics*, 123(10) :1060–1069, 1997.
- [39] S. T. Grilli, J. Skourup, and I. A. Svendsen. An efficient boundary element method for nonlinear water waves. *Engineering Analysis with Boundary Elements*, 6(2) :97–107, 1989.
- [40] S. T. Grilli and R. Subramanya. Quasi-singular integrations in the modelling of nonlinear water waves. *Engineering Analysis with Boundary Elements*, 13(2) :181–191, 1994.
- [41] S. T. Grilli and R. Subramanya. Numerical modeling of wave breaking induced by fixed or moving boundaries. *Computational Mechanics*, 17(6) :374–391, 1996.
- [42] S. T. Grilli and I. A. Svendsen. Corner problems and global accuracy in the boundary element solution of nonlinear wave flows. *Engineering Analysis with Boundary Elements*, 7(4) :178–195, 1990.
- [43] J. Grue and K. Granlund. Impact of nonlinearity upon waves traveling over a submerged cylinder. In *Proceedings of the 3rd International Workshop on Water Waves and Floating Bodies (IWWWFB)*, 1988.
- [44] N. M. Gunther. *La théorie du potentiel et ses applications aux problèmes fondamentaux de la physique mathématique (in French)*. Gauthier-Villars, 1934.
- [45] P. Guyenne and S. T. Grilli. Numerical study of three-dimensional overturning waves in shallow water. *Journal of Fluid Mechanics*, 547 :361–388, 2006.
- [46] M. D. Haskind. The exciting forces and wetting of ships in waves. *DTMB Translation*, 307, 1957.
- [47] K. Hasselmann, T. P. Barnett, E. Bouws, H. Carlson, D. E. Cartwright, K. Enke, J. A. Ewing, D. E. Hasselmann, P. Kruseman, A. Meerburg, P. Müller, D. J. Olbers, K. Richter, W. Sell, and H. Walden. Measurement of wind-wave growth and swell decay during the joint north sea wave project (JONSWAP). *Erganzungsheft zur Deutschen Hydrographischen Zeitschrift Reihe*, 8(12) :95, 1973.
- [48] H. Honji. Streaked flow around an oscillating circular cylinder. *Journal of Fluid Mechanics*, 107 :509–520, 1981.
- [49] M. Ikeno. A numerical model for 3-D floating body motion in nonlinear waves using the BEM. In *Proceedings of the 10th International Offshore and Polar Engineering Conference (ISOPE)*, 2000.
- [50] International Energy Agency. *Renewable Energy : market and policy trends in IEA countries*, OECD Publishing edition, 2004.

- [51] M. Kashiwagi. Fully-nonlinear simulations of hydrodynamic forces on a heaving two-dimensional body. *Journal of the Society of Naval Architects of Japan*, 180 :373–381, 1996.
- [52] O. D. Kellog. *Foundations of potential theory*. Berlin, 1979.
- [53] C. P. Kent and W. Choi. An explicit formulation for the evolution of nonlinear surface waves interacting with a submerged body. *International Journal for Numerical Methods in Fluids*, 55(11) :1019–1038, 2007.
- [54] W. Koo and M. H. Kim. Freely floating-body simulation by a 2D fully nonlinear numerical wave tank. *Ocean Engineering*, 31(16) :2011–2046, 2004.
- [55] W. Koo and M. H. Kim. Numerical simulation of nonlinear wave and force generated by a wedge-shape wave maker. *Ocean Engineering*, 33(8-9) :983–1006, 2006.
- [56] W. Koo and M. H. Kim. Fully nonlinear wave-body interactions with surface-piercing bodies. *Ocean Engineering*, 34(7) :1000–1012, 2007.
- [57] Y. Liu, D. G. Dommermuth, and D. K. P. Yue. A high-order spectral method for nonlinear wave-body interactions. *Journal of Fluid Mechanics*, 245 :115–136, 1992.
- [58] M. S. Longuet-Higgins and E. Cockelet. The deformation of steep surface waves on water i. A numerical method of computation. *Proceedings of the Royal Society of London*, A. 350 :1–26, 1976.
- [59] R. Luquet, L. Gentaz, and B. Alessandrini. Viscous flow simulation past a ship in waves using the SWENSE approach. In *Proceedings of the 25th Symposium on Naval Hydrodynamics*, 2004.
- [60] L. D. Mann, A. R. Burns, and M. E. Ottaviano. CETO, a carbon free wave power energy provider of the future. In *Proceedings of the 7th European Wave and Tidal Energy Conference (EWTEC)*, 2007.
- [61] C. C. Mei. Power extraction from water waves. *Journal of Ship Research*, 20 :63–66, 1976.
- [62] B. Molin. *Hydrodynamique des Structures Offshore*. Guide Pratique sur les ouvrages en mer CLAROM. Editions TECHNIP, 2002.
- [63] J. N. Newman. The exciting forces on fixed bodies in waves. *Journal of Ship Results*, 6(4) :10–17, 1962.
- [64] N. M. Newmark. A method of computation for structural dynamics. *Journal of the Engineering Mechanics Division, ASCE*, 85 :67–94, 1959.
- [65] T. F. Ogilvie. First- and second-order forces on a cylinder submerged under a free surface. *Journal of Fluid Mechanics*, 16(3) :451–472, 1963.
- [66] T. Sarpkaya. Force on a circular cylinder in viscous oscillatory flow at low Keulegan-Carpenter numbers. *Journal of Fluid Mechanics*, 165 :61–71, 1986.
- [67] D. Sen. Numerical simulation of motions of two-dimensional floating bodies. *Journal of Ship Research*, 37(4) :307–330, 1993.
- [68] Y. Shirakura, K. Tanizawa, and S. Naito. Development of 3-D fully nonlinear numerical wave tank to simulate floating bodies interacting with water waves. In *Proceedings of the 10th International Offshore and Polar Engineering Conference (ISOPE)*, 2000.
- [69] M. A. Srokosz. The submerged sphere as an absorber of wave power. *Journal of Fluid Mechanics*, 95(4) :717–741, 1979.

-
- [70] M. A. Srokosz and D. V. Evans. A theory for wave-power absorption by two independently oscillating bodies. *Journal of Fluid Mechanics*, 90(2) :337–362, 1979.
- [71] B. M. Sumer and J. Fredsøe. *Hydrodynamics around cylindrical structures*, volume 12 of *Advanced series on Ocean Engineering*. World Scientific, 1997.
- [72] K. Tanizawa. A nonlinear simulation method of 3D body motions in waves, 1st report. *Journal of the Society of Naval Architects of Japan*, 178 :179–191, 1995.
- [73] K. Tanizawa. The state of art on numerical wave tank. In *Proceedings of the 4th Osaka Colloquium on Seakeeping Performance of Ships*, pages 95–104, October 2000.
- [74] A. Tavassoli and M. H. Kim. Two-dimensional viscous-flow simulations for a circular cylinder in motion. In *Proceedings of the 10th International Offshore and Polar Engineering Conference (ISOPE)*, pages 478–485, June 2000.
- [75] A. Tavassoli and M. H. Kim. Interactions of fully nonlinear waves with submerged bodies by a 2D viscous NWT. In *Proceedings of the 11th International Offshore and Polar Engineering Conference (ISOPE)*, pages 348–354, June 2001.
- [76] G. R. Thomas. *A Combined High-Order Spectral and Boundary Integral Equation Method for Modelling Wave Interactions with Submerged Bodies*. PhD thesis, Massachusetts Institute of Technology, USA, 2007.
- [77] F. Ursell. Surface waves in the presence of a submerged circular cylinder, I and II. *Mathematical Proceedings of the Cambridge Philosophical Society*, 46(1) :141–158, 1949.
- [78] E. F. G. van Daalen. *Numerical and Theoretical Studies of Water Waves and Floating Bodies*. PhD thesis, Universiteit Twente, The Netherlands, 1993.
- [79] T. Vinje and P. Brevig. Nonlinear, two-dimensional ship motions. Technical Report R-112.81, 1981.
- [80] G. X. Wu. Hydrodynamic forces on a submerged circular cylinder undergoing large-amplitude motion. *Journal of Fluid Mechanics*, 254 :41–58, 1993.
- [81] G. X. Wu and R. Eatock-Taylor. Transient motion of a floating body in steep water waves. In *Proceedings of the 11th International Workshop on Water Waves and Floating Bodies (IWWWFB)*, 1996.
- [82] G. X. Wu and R. Eatock-Taylor. The coupled finite element and boundary element analysis of nonlinear interactions between waves and bodies. *Ocean Engineering*, 30 :387–400, 2003.
- [83] S. C. Yim, H. Lin, D. C. Robinson, and K. Tanizawa. Predictive capability of a 2D FNPF fluid-structure interaction model. *Journal of Offshore Mechanics and Arctic Engineering*, 131 :1–9, 2009.
- [84] S. C. Yim and K. Tanizawa. FNPF analysis of stochastic experimental fluid-structure interaction systems. *Journal of Offshore Mechanics and Arctic Engineering*, 129 :9–20, 2007.
- [85] X. T. Zhang, B. C. Khoo, and J. Lou. Wave propagation in a fully nonlinear numerical wave tank : A desingularized method. *Ocean Engineering*, 33 :2310–2331, 2006.

Publications et communications durant la thèse

A. Articles de revues internationales avec comité de lecture :

- E. Guerber, M. Benoit, S. Grilli, and C. Buvat. A fully nonlinear implicit model for wave interactions with submerged structures in forced or free motion. *Engineering Analysis with Boundary Elements*, to appear (currently under minor revision).

B. Articles de revues nationales avec comité de lecture :

- E. Guerber, M. Benoit, S. Grilli, and C. Buvat. Modélisation non-linéaire des interactions des vagues avec un corps mobile immergé (in French). *Revue Paralia*, 4, 2.1-2.12, 2011.
- E. Guerber, M. Benoit, S. Grilli, and C. Buvat. Etude numérique des effets non-linéaires sur la dynamique d'un système houlomoteur cylindrique immergé (in French). *La Houille Blanche*, to appear (currently under minor revision).

C. Communications de conférences internationales avec actes et comité de lecture :

- E. Guerber, M. Benoit, S. Grilli, and C. Buvat. Numerical modeling of fully nonlinear interactions of ocean waves with a submerged moving body. *Proceedings of the IVth European Conference on Computational Mechanics (ECCM)*, 16-21 Mai 2010, Paris (France).
- E. Guerber, M. Benoit, S. Grilli, and C. Buvat. Modeling of Fully Nonlinear Wave Interactions with Moving Submerged Structures. *Proceedings of the 20th International Offshore and Polar Engineering Conference (ISOPE)*, 21-25 Juin 2010, Pékin (Chine).

D. Communications de conférences nationales avec actes et comité de lecture :

- E. Guerber, M. Benoit, S. Grilli, and C. Buvat. Modélisation non-linéaire des interactions des vagues avec un corps mobile immergé (in French). *Actes des XI^{èmes} Journées Nationales Génie Civil Génie Côtier*, 22-24 Juin 2010, Les Sables d'Olonne (France).
- E. Guerber, M. Benoit, S. Grilli, and C. Buvat. Etude numérique des effets non-linéaires sur la dynamique d'un système houlomoteur cylindrique immergé (in French). *Actes des 12^{èmes} Journées de l'Hydrodynamique*, 17-19 Novembre 2010, Nantes (France).

E. Poster de conférences internationales avec actes :

- E. Guerber, M. Benoit, S. Grilli, and C. Buvat. Numerical modeling of fully nonlinear interactions of ocean waves with a submerged moving body. *Proceedings of the 3rd International Conference on Ocean Energy (ICOE)*, 6-8 Octobre 2010, Bilbao (Espagne).

Modélisation numérique des interactions non-linéaires entre vagues et structures immergées, appliquée à la simulation de systèmes houlomoteurs

Résumé

Cette thèse présente le développement d'un modèle numérique avancé, capable de simuler les interactions entre des vagues de surface de cambrure quelconque et des corps rigides immergés ayant des mouvements de grande amplitude. Fondé sur la théorie potentielle, il propose une résolution couplée de la dynamique vagues/structure par la méthode implicite de Van Daalen (1993), encore appelée méthode du potentiel d'accélération par Tanizawa (1995). La précision du modèle à deux dimensions est testée sur un ensemble d'applications impliquant le mouvement forcé ou libre d'un cylindre horizontal immergé, de section circulaire : diffraction par un cylindre fixe, radiation par un cylindre en mouvement forcé de grande amplitude, absorption des vagues par le cylindre de Bristol. Pour chaque application, les résultats numériques sont comparés à des résultats expérimentaux ou analytiques issus de la théorie linéaire, avec un bon accord en particulier pour les petites amplitudes de mouvement du cylindre et pour les vagues de faibles cambrures. La génération de vagues irrégulières et la prise en compte d'un second corps cylindrique immergé sont ensuite intégrées au modèle, et illustrées sur des applications pratiques avec des systèmes récupérateurs d'énergie des vagues simples. Enfin, le modèle est étendu en trois dimensions avec des premières applications au cas d'une sphère décrivant des mouvements de grande amplitude.

Mots-clés: Vagues non-linéaires, canal à houle numérique, dynamique de corps rigide, système récupérateur d'énergie des vagues, interactions vagues-structures.

Abstract

This PhD is dedicated to the development of an advanced numerical model for simulating interactions between free surface waves of arbitrary steepness and rigid bodies in high amplitude motions. Based on potential theory, it solves the coupled dynamics of waves and structure with the implicit method by Van Daalen (1993), also named the acceleration potential method by Tanizawa (1995). The precision of this two-dimensional model is tested on a wide range of applications involving the forced motion or free motion of a submerged horizontal cylinder of circular cross-section : diffraction by a fixed cylinder, radiation by a cylinder in specified high amplitude motions, wave absorption by the Bristol cylinder. In each of these applications, numerical results are compared to experimental data or analytical solutions based on the linear wave theory, with a good agreement especially for small amplitude motions of the cylinder and small wave steepnesses. The irregular wave generation by a paddle and the possibility to add an extra circular cylinder are integrated in the model and illustrated on practical applications with simple wave energy converters. The model is finally extended to three dimensions, with preliminary results for a sphere in large amplitude heaving oscillations.

Keywords: Nonlinear waves, numerical wave tank, rigid body dynamics, wave energy converter, wave-structure interactions.

