

Second Edition

Handbook of Natural Fibres

Volume 2: Processing and Applications



Edited by
Ryszard M. Kozłowski and Maria Mackiewicz-Talarczyk



THE TEXTILE INSTITUTE BOOK SERIES

Handbook of Natural Fibres

The Textile Institute Book Series

Incorporated by Royal Charter in 1925, The Textile Institute was established as the professional body for the textile industry to provide support to businesses, practitioners and academics involved with textiles and to provide routes to professional qualifications through which Institute Members can demonstrate their professional competence. The Institute's aim is to encourage learning, recognise achievement, reward excellence and disseminate information about the textiles, clothing and footwear industries and the associated science, design and technology; it has a global reach with individual and corporate members in over 80 countries.

The Textile Institute Book Series supersedes the former 'Woodhead Publishing Series in Textiles' and represents a collaboration between The Textile Institute and Elsevier aimed at ensuring that Institute Members and the textile industry continue to have access to high calibre titles on textile science and technology.

Books published in The Textile Institute Book Series are offered on the Elsevier web site at: store.elsevier.com and are available to Textile Institute Members at a substantial discount. Textile Institute books still in print are also available directly from the Institute's web site at: www.textileinstitute.org

To place an order, or if you are interested in writing a book for this series, please contact Matthew Deans, Senior Publisher: m.deans@elsevier.com

Recently Published and Upcoming Titles in The Textile Institute Book Series

- Advances in Textile Biotechnology*, Artur Cavaco-Paulo, 978-0-08-102632-8
Woven Textiles: Principles, Technologies and Applications, 2nd Edition, Kim Gandhi, 978-0-08-102497-3
Auxetic Textiles, Hong Hu, 978-0-08-102211-5
Carbon Nanotube Fibres and Yarns: Production, Properties and Applications in Smart Textiles, Menghe Miao, 978-0-08-102722-6
Sustainable Technologies for Fashion and Textiles, Rajkishore Nayak, 978-0-08-102867-4
Structure and Mechanics of Textile Fibre Assemblies, Peter Schwartz, 978-0-08-102619-9
Silk: Materials, Processes, and Applications, Narendra Reddy, 978-0-12-818495-0
Anthropometry, Apparel Sizing and Design, 2nd Edition, Norsaadah Zakaria, 978-0-08-102604-5
Engineering Textiles: Integrating the Design and Manufacture of Textile Products, 2nd Edition, Yehia Elmogahzy, 978-0-08-102488-1
New Trends in Natural Dyes for Textiles, Padma Vankar Dhara Shukla, 978-0-08-102686-1
Smart Textile Coatings and Laminates, 2nd Edition, William C. Smith, 978-0-08-102428-7
Advanced Textiles for Wound Care, 2nd Edition, S. Rajendran, 978-0-08-102192-7
Manikins for Textile Evaluation, Rajkishore Nayak Rajiv Padhye, 978-0-08-100909-3
Automation in Garment Manufacturing, Rajkishore Nayak and Rajiv Padhye, 978-0-08-101211-6
Sustainable Fibres and Textiles, Subramanian Senthilkannan Muthu, 978-0-08-102041-8
Sustainability in Denim, Subramanian Senthilkannan Muthu, 978-0-08-102043-2
Circular Economy in Textiles and Apparel, Subramanian Senthilkannan Muthu, 978-0-08-102630-4
Nanofinishing of Textile Materials, Majid Montazer Tina Harifi, 978-0-08-101214-7
Nanotechnology in Textiles, Rajesh Mishra Jiri Militky, 978-0-08-102609-0
Inorganic and Composite Fibers, Boris Mahltig Yordan Kyosev, 978-0-08-102228-3
Smart Textiles for In Situ Monitoring of Composites, Vladan Koncar, 978-0-08-102308-2
Handbook of Properties of Textile and Technical Fibres, 2nd Edition, A. R. Bunsell, 978-0-08-101272-7
Silk, 2nd Edition, K. Murugesh Babu, 978-0-08-102540-6

The Textile Institute Book Series

Handbook of Natural Fibres

Volume 2: Processing and Applications

Second Edition

Edited by

Ryszard M. Kozłowski

Maria Mackiewicz-Talarczyk



The Textile Institute



ELSEVIER

WP

WOODHEAD
PUBLISHING

An imprint of Elsevier

Woodhead Publishing is an imprint of Elsevier
The Officers' Mess Business Centre, Royston Road, Duxford, CB22 4QH, United Kingdom
50 Hampshire Street, 5th Floor, Cambridge, MA 02139, United States
The Boulevard, Langford Lane, Kidlington, OX5 1GB, United Kingdom

Copyright © 2020 Elsevier Ltd. All rights reserved.

No part of this publication may be reproduced or transmitted in any form or by any means, electronic or mechanical, including photocopying, recording, or any information storage and retrieval system, without permission in writing from the publisher. Details on how to seek permission, further information about the Publisher's permissions policies and our arrangements with organizations such as the Copyright Clearance Center and the Copyright Licensing Agency, can be found at our website: www.elsevier.com/permissions.

This book and the individual contributions contained in it are protected under copyright by the Publisher (other than as may be noted herein).

Notices

Knowledge and best practice in this field are constantly changing. As new research and experience broaden our understanding, changes in research methods, professional practices, or medical treatment may become necessary.

Practitioners and researchers must always rely on their own experience and knowledge in evaluating and using any information, methods, compounds, or experiments described herein. In using such information or methods they should be mindful of their own safety and the safety of others, including parties for whom they have a professional responsibility.

To the fullest extent of the law, neither the Publisher nor the authors, contributors, or editors, assume any liability for any injury and/or damage to persons or property as a matter of products liability, negligence or otherwise, or from any use or operation of any methods, products, instructions, or ideas contained in the material herein.

Library of Congress Cataloging-in-Publication Data

A catalog record for this book is available from the Library of Congress

British Library Cataloguing-in-Publication Data

A catalogue record for this book is available from the British Library

ISBN: 978-0-12-818782-1

For information on all Woodhead Publishing publications visit our website at <https://www.elsevier.com/books-and-journals>

Publisher: Matthew Deans

Acquisitions Editor: Brian Guerin

Editorial Project Manager: Ana Claudia A. Garcia

Production Project Manager: Sreejith Viswanathan

Cover Designer: Mark Rogers

Partial cover designers: Katarzyna Schmidt-Przewoźna
and Jacek Kołodziej, Poland

Typeset by TNQ Technologies



Contents

Contributors	xiii
Part One Processing techniques for natural fibres	1
1 Cotton fibres, picking, ginning, spinning and weaving	3
<i>Mohamed Negm and Suzan Sanad</i>	
1.1 World fibre production and use	3
1.2 Fibre growth development	7
1.3 Cotton fibre quality properties	10
1.4 Cotton picking	15
1.5 Ginning mill processes and technology	16
1.6 Cotton classification	21
1.7 Cotton grading	22
1.8 Cotton yarn spinning	23
1.9 Yarn testing	30
1.10 Weaving	32
1.11 Terry towel	36
1.12 Knitting	38
1.13 Fabric testing	42
1.14 Nondestructive testing	44
1.15 Conclusion	45
References	47
Further reading	48
2 Processing of jute fibres and its applications	49
<i>Ashis Kumar Samanta, Asis Mukhopadhyay and Swapan Kumar Ghosh</i>	
2.1 Jute fibre	49
2.2 Chemical composition and structure of jute fibre	52
2.3 Chemical aspects and effect of chemical treatments of jute fibres	60
2.4 Mechanical processing of jute: spinning of jute yarns	67
2.5 Jute weaving	69
2.6 Chemical processing of jute	74
2.7 Eco-friendly processing of jute	102
2.8 Diversified end uses of jute as technical textiles	106

2.9	Conclusions and future trends	111
2.10	Sources of further information and knowledge on jute	112
	References	112
	Further reading	119
3	Silk – production and future trends	121
	<i>K. Murugesh Babu</i>	
3.1	Introduction to silk and silk industry	121
3.2	Types of silk and their importance	124
3.3	Silk industry	130
3.4	Post-cocoon technology	132
3.5	Silk reeling technology	133
3.6	Silk fabric manufacture	136
3.7	Spun silk production	140
3.8	Future trends in natural silk production	143
3.9	Sources of further information and advice	144
	Acknowledgements	144
	References	144
4	The use of flax and hemp for textile applications	147
	<i>Małgorzata Muzyczek</i>	
4.1	Introduction	147
4.2	Types of flax used for textile applications	148
4.3	Applications and examples	155
4.4	Future trends and conclusions	161
4.5	Sources of further information and advice	163
	References	166
5	Use of bast fibres including flax fibres for high challenge technical textile applications. Extraction, preparation and requirements for the manufacturing of composite reinforcement fabrics and for geotextiles	169
	<i>Pierre Ouagne, Damien Soulat, Philippe Evon, Sullivan Renouard, Manuela Ferreira, Laurent Labonne, Ahmad Rashed Labanieh, Eric Laine and Emmanuel De Luycker</i>	
5.1	Introduction	169
5.2	Impact of extraction and preparation of flax fibres for technical applications for differently harvested stems	171
5.3	Composite reinforcement textiles: use of processes that can maximise the mechanical and the deformability of textile reinforcement structures	176
5.4	Flax fibre geotextiles	190
5.5	Conclusions	195
	References	196

6	Multi-scale mechanical characterization of flax fibres for the reinforcement of composite materials	205
	<i>Alain Bourmaud, Lucile Nuez, Camille Goudenhoofft and Christophe Baley</i>	
6.1	Introduction	205
6.2	Link between stem structure and fibre performance: flax plant, a model for biomimetics	206
6.3	Multi-scale mechanical characterization of flax	208
6.4	Conclusion	221
	References	221
7	Enzymatic treatment of natural fibres	227
	<i>Ryszard M Kozłowski and Wanda Róžańska</i>	
7.1	Introduction	227
7.2	Key principles of enzyme treatment of natural fibres	227
7.3	Main types of enzyme treatments for natural fibres	234
7.4	Future trends	239
7.5	Sources of further information and advice	239
	References	240
	Further reading	244
8	Improving the properties of natural fibres by chemical treatments	245
	<i>John A. Rippon and David J. Evans</i>	
8.1	Introduction	245
8.2	Wool	246
8.3	Silk	280
8.4	Cotton	287
8.5	Other vegetable fibres	305
8.6	Future trends	307
	Appendix: abbreviations	307
	Acknowledgements	308
	References	308
9	Electrokinetic properties of natural fibres	323
	<i>Thomas Luxbacher</i>	
9.1	Introduction	323
9.2	Key principles of electrokinetic properties of natural fibres	324
9.3	Applications	335
9.4	Future trends	346
9.5	Conclusion	347
9.6	Sources of further information and advice	348
	Appendix: symbols and abbreviations	349
	References	350

10	Improving the flame retardancy of natural fibres	355
	<i>Ryszard M. Kozłowski and Małgorzata Muzyczek</i>	
10.1	Introduction	355
10.2	Key issues in flame retardancy of natural fibres and lignocellulosic textiles	362
10.3	Flammability and flame retardancy of some natural fibres and textiles	368
10.4	Methods of improving flame retardancy in natural fibres	378
10.5	Future trends	384
10.6	Sources of further information and advice	386
10.7	Conclusions	387
	References	388
11	Bast fibres: the role of hemp (<i>Cannabis sativa</i> L.) in remediation of degraded lands	393
	<i>Jerzy Mańkowski, Jacek Kołodziej, Krzysztof Pudetko and Ryszard M. Kozłowski</i>	
11.1	Introduction	393
11.2	Key issues in recultivation of polluted lands	394
11.3	Methods of recultivation and remediation of polluted lands	398
11.4	The results	403
11.5	Future trends	413
11.6	Conclusion	414
	References	414
	Sources of further information and advice	416
12	Medical potential of cannabis: an overview	419
	<i>Dariusz Michał Zielonka, Łukasz Kiraga and Ryszard M. Kozłowski</i>	
12.1	Plant biology	419
12.2	Human and medicine	427
12.3	Conclusions and prospects	440
	Abbreviations	441
	References	441
Part Two	Applications and case studies for natural fibres	449
13	Chemical and physical characteristic of modified cotton and linen fabrics with amine-terminated dendritic polymer	451
	<i>Somaye Akbari, A. Asayesh, S. Khaliliazar, M. Razipour and N. Esmaeeli</i>	
13.1	Introduction	451
13.2	Cotton and linen fabrics modification procedure by amine-terminated dendritic polymer	454
13.3	Effect of modified cotton and linen fabrics by amine-terminated dendritic polymers	455

13.4	Future trends	463
13.5	Sources of further information and advice	465
	References	465
14	Natural fibre composites (NFCs) for construction and automotive industries	469
	<i>Yong K. Kim and Vijaya Chalivendra</i>	
14.1	Introduction	469
14.2	Natural fibre composites (NFCs)	471
14.3	Natural fibre reinforcement forms for green composites	477
14.4	NFC manufacturing methods	480
14.5	Quality assurance and testing	484
14.6	NFCs for building and automotive industries	488
14.7	Conclusions	494
14.8	Future trends	495
	Acknowledgements	495
	References	496
	Further reading	498
15	Natural fibres for geotextiles	499
	<i>Sivoney Ferreira de Souza, Bibin Mathew Cherian, Alcides Lopes Leão, Ryszard M. Kozłowski and Sabu Thomas</i>	
15.1	Introduction	499
15.2	Natural vegetable fibres for geotextiles and their suitability	500
15.3	Types of synthetic geotextiles	501
15.4	Market size of natural fibre geotextile	503
15.5	Functional requirements of geosynthetic materials	504
15.6	Primary uses for geotextiles	507
15.7	Applications	511
15.8	Future trends	525
15.9	Source of further information	526
15.10	Conclusions	527
	Acknowledgements	527
	References	528
16	Properties and applications of ultrafine powders produced from natural fibres	531
	<i>Rangam Rajkhowa and Xungai Wang</i>	
16.1	Introduction	531
16.2	Production of natural fibre powder by milling	532
16.3	Powder characterization	541
16.4	Applications of natural fibre particles	550
16.5	Conclusion and outlook	553
	References	554

17	The application of flax and hempseed in food, nutraceutical and personal care products	557
	<i>Anna Bakowska-Barczak, Marie-Anne de Larminat and Paul P. Kolodziejczyk</i>	
17.1	Introduction	557
17.2	The economic factors affecting flax and hemp industrial production	558
17.3	Properties and chemical composition of flax and hempseed	560
17.4	Nutritional and health effects of flax and hemp	563
17.5	Flax and hemp related products for food and dietary supplements for human and animal nutrition	569
17.6	Regulatory issues regarding novel flax and hemp products	572
17.7	Application of flax and hemp in cosmetics and personal care	573
17.8	Conclusion	581
	References	582
	Further reading	589
18	Natural fibres for paper and packaging	591
	<i>Raphaël Passas</i>	
18.1	Introduction	591
18.2	Available natural raw materials for paper and packaging	591
18.3	Pulping and papermaking processes	602
18.4	New challenges for paper and board producers	612
18.5	Conclusions and futures trends	614
	Acknowledgements	615
	References	615
	Further reading	619
19	Environmental textiles from jute and coir	621
	<i>P.K. Banerjee</i>	
19.1	Introduction to environmental textiles	621
19.2	The importance of jute and coconut plant cultivation	622
19.3	Extraction of jute and coir fibres	627
19.4	Critical properties of jute and coir fibres	628
19.5	The nature of commercial products from jute and coir	629
19.6	Some novel environmental textiles from jute and coir	631
19.7	Market potential of jute-coir environmental textiles	647
19.8	Conclusion	648
	List of abbreviations	649
	References	649
20	Antimicrobial natural fibres	653
	<i>Judit Borsa</i>	
20.1	Introduction to textiles and microbial hazards: past and present	653
20.2	Survival of microbes on fabric surfaces	654

20.3	Textiles as protection against biohazards and as infection reservoirs	656
20.4	Antimicrobial fibres	658
20.5	Antimicrobial agents: silver, other metals and their salts	660
20.6	Antimicrobial agents: quaternary ammonium compounds	662
20.7	Antimicrobial agents: chitosan	664
20.8	Antimicrobial agents: dyes	666
20.9	Antimicrobial agents: photomicrobicidal materials	667
20.10	Antimicrobial agents: natural agents	669
20.11	Antimicrobial agents: others	670
20.12	Risks of antimicrobial finishing	672
20.13	Future trends	673
	References	674
	Further reading	687
21	Biomimetics and textile materials	689
	<i>Michael S. Ellison</i>	
21.1	Introduction	689
21.2	Key principles of biomimesis	691
21.3	Key principles and issues of biomimetic inspired textiles	694
21.4	Conclusions and future trends	697
	Acknowledgements	699
	References	699
	Index	701

This page intentionally left blank

Contributors

Somaye Akbari Department of Textile Engineering, Amirkabir University of Technology (Polytechnic Tehran), Tehran, Iran

A. Asayesh Department of Textile Engineering, Amirkabir University of Technology (Polytechnic Tehran), Tehran, Iran

Anna Bakowska-Barczak Formulation & Product Development Lead, Process & Product Development, Radiant Technologies Inc., Edmonton, AB, Canada

Christophe Baley Université de Bretagne-Sud, IRDL, CNRS UMR 6027, BP 92116, Lorient Cedex, France

P.K. Banerjee Department of Textile Technology, Indian Institute of Technology, New Delhi, India

Judit Borsa Óbuda University, Budapest, Hungary

Alain Bourmaud Université de Bretagne-Sud, IRDL, CNRS UMR 6027, BP 92116, Lorient Cedex, France

Vijaya Chalivendra University of Massachusetts Dartmouth, North Dartmouth, MA, United States

Bibin Mathew Cherian College of Agricultural Sciences, São Paulo State University, Botucatu, São Paulo, Brazil

Emmanuel De Luycker ENIT, LGP, EA 1905, Tarbes Cedex, France

Sivoney Ferreira de Souza University of Potsdam, Institute of Chemistry, Physical Chemistry, Potsdam, Germany

Michael S. Ellison Clemson University, Clemson, South Carolina, United States

N. Esmaeeli Department of Textile Engineering, Amirkabir University of Technology (Polytechnic Tehran), Tehran, Iran

David J. Evans Formerly of CSIRO Materials Science and Engineering, VIC, North Melbourne, Australia

Philippe Evon Laboratoire de Chimie Agro-industrielle (LCA), Université de Toulouse, INRA, INPT, Toulouse, France

Manuela Ferreira University of Lille, GEMTEX, ENSAIT, Roubaix, France

Swapan Kumar Ghosh Department of Jute and Fibre Technology, Institute of Jute Technology, University of Calcutta, Kolkata, West Bengal, India

Camille Goudenhooff Université de Bretagne-Sud, IRDL, CNRS UMR 6027, BP 92116, Lorient Cedex, France

S. Khaliliazar Department of Textile Engineering, Amirkabir University of Technology (Polytechnic Tehran), Tehran, Iran

Yong K. Kim University of Massachusetts Dartmouth, North Dartmouth, MA, United States

Łukasz Kiraga Warsaw University of Life Sciences, DVM Department of Physiological Sciences Faculty of Veterinary Medicine, Warsaw, Mazowieckie, Poland

Jacek Kołodziej Institute of Natural Fibres and Medicinal Plants IWNiRZ, Poznań, Poland

Paul P. Kolodziejczyk Biolink Consultancy, New Denver, BC, Canada

Ryszard M. Kozłowski Journal of Natural Fibers Editor-in-chief, coordinator of FAO/SCORENA European Cooperative Research Network on Flax and other Bast Plants, former director of the Institute of Natural Fibres, Poznan, Poland

Ahmad Rashed Labanieh University of Lille, GEMTEX, ENSAIT, Roubaix, France

Laurent Labonne Laboratoire de Chimie Agro-industrielle (LCA), Université de Toulouse, INRA, INPT, Toulouse, France

Eric Laine Institut de Chimie et de Biologie des Membranes et des nano-objets, CNRS UMR 5248, Bordeaux University, Pessac, France

Marie-Anne de Larminat Biolink Consultancy, New Denver, BC, Canada

Alcides Lopes Leão College of Agricultural Sciences, São Paulo State University, Botucatu, São Paulo, Brazil

Thomas Luxbacher Anton Paar GmbH, Graz, Austria

Jerzy Mańkowski Institute of Natural Fibres and Medicinal Plants (IWNiRZ), Poznań, Poland

Asis Mukhopadhyay Department of Jute and Fibre Technology, Institute of Jute Technology, University of Calcutta, Kolkata, West Bengal, India

K. Murugesh Babu Department of Textile Technology, Bapuji Institute of Engineering and Technology, Davangere, Karnataka, India

Małgorzata Muzyczek Journal of Natural Fibers, Taylor & Francis Group, Poznan, Poland

Mohamed Negm Cotton Research Institute, Giza, Egypt

Lucile Nuez Université de Bretagne-Sud, IRDL, CNRS UMR 6027, BP 92116, Lorient Cedex, France; Van Robaey Frères, Killeme, France

Pierre Ouagne ENIT, LGP, EA 1905, Tarbes Cedex, France

Krzysztof Pudełko Poznań University of Life Sciences (UP – Poznań), Department of Biochemistry and Biotechnology, Poznań, Poland

Rangam Rajkhowa Deakin University, Institute for Frontier Materials, Geelong, Victoria, Australia

Raphaël Passas University of Grenoble Alpes, CNRS, Grenoble INP (Institute of Engineering, University of Grenoble Alpes), LGP2, Grenoble, France

M. Razipour Department of Textile Engineering, Amirkabir University of Technology (Polytechnic Tehran), Tehran, Iran

Sullivan Renouard University Orléans, LBLGC EA1207, Antenne scientifique de Chartres, Chartres, France

John A. Rippon Formerly CSIRO Materials Science and Engineering, Torquay, VIC, Australia

Wanda Róžańska Institute of Natural Fibres and Medicinal Plants, Poznań, Poland

Ashis Kumar Samanta Department of Jute and Fibre Technology, Institute of Jute Technology, University of Calcutta, Kolkata, West Bengal, India

Suzan Sanad Cotton Research Institute, Giza, Egypt

Damien Soulat University of Lille, GEMTEX, ENSAIT, Roubaix, France

Sabu Thomas Department of Polymer Science and Engineering, School of Chemical Sciences, Mahatma Gandhi University, Kottayam, Kerala, India

Xungai Wang Deakin University, Institute for Frontier Materials, Geelong, Victoria, Australia

Dariusz Michał Zielonka Warsaw University of Life Sciences, Autonomous Department of Microorganisms' Biology, Faculty of Agriculture and Biology, Warsaw, Mazowieckie, Poland

This page intentionally left blank

Part One

Processing techniques for natural fibres

This page intentionally left blank

Cotton fibres, picking, ginning, spinning and weaving

1

Mohamed Negm, Suzan Sanad
Cotton Research Institute, Giza, Egypt

1.1 World fibre production and use

After some downward revisions in 2016, 2017 will be remembered as a milestone in which the market size of fibre surpassed the incredible volume of 100 million tons.

The textile fibres production in the global scale increased by 5% up to 103 million tons owing to the fasted cotton expansion: by 26 million tons in 2018, while man-made fibres production increased to nearly 72 million tons, other natural fibres hardly reached 6 million tons (Fig. 1.1).

World textile fibre consumption per capita more than doubled between 1960 and 2017, from 5 to 12.6 kg. However, whereas textile fibre consumption per capita in developing countries showed a fourfold increase over that period, it increased by 156% in industrial countries and it decreased by 3% in Central and Eastern Europe and ex-Union of Soviet Socialist Republics countries. The relevance of developing countries in world textile fibre consumption has been accentuated by their population growth: the population in developing countries totalled 3.3 times that in industrial countries in 1960 and 6.6 times in 2017 (Fig. 1.2).

1.1.1 World cotton production, consumption and trade

Cotton and cotton textile industries are central to the economic growth of world countries. Cotton had an important role in industrial development starting during the European Industrial Revolution. It continues to have a vital role in the developing world as a major source of revenue. The world cotton production in 2018-2019 was 26.26 million tons with an average world price of about US \$1.75/kg of lint cotton.

1.1.2 World cotton production

The growth of cotton production was steady during the 1960s. World cotton production exploded from 3.8 million tons in the 1980s to 19.5 million tons in the 2000s, supported by commercial biotech cotton varieties in the main cotton producers (i.e. the United States, India, China, Brazil and Pakistan). World cotton production reached 27 million tons in 2011 and remained at that level until 2018.

Source: ICAC, World Cotton statistics 2017.

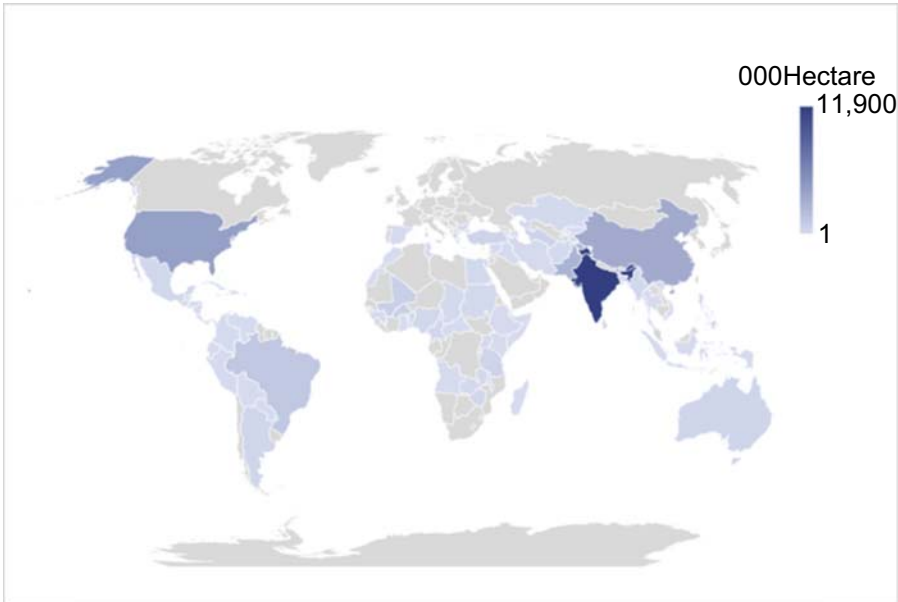

Figure 1.1 World cotton production.

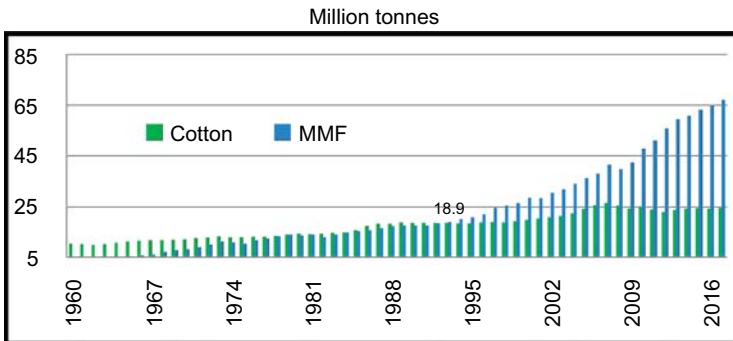

Figure 1.2 Production of cotton and man-made fibre (MMF).

From ICAC, Research Associated Program, Lorena Ruiz World Textile Demand – 2018.

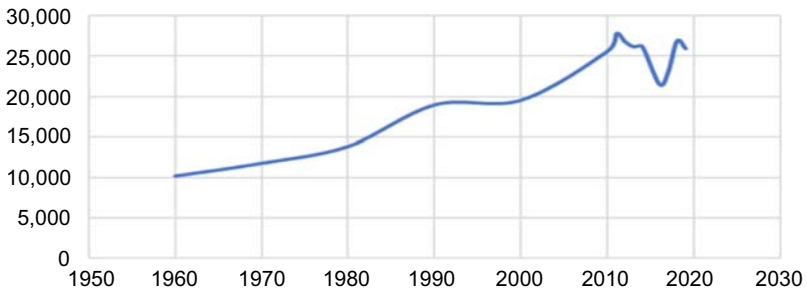

Figure 1.3 World cotton production ‘000 tons’.

From ICAC world cotton statistics 2017.



Figure 1.4 Main countries of cotton production. *Uzbe*, Uzbekistan.

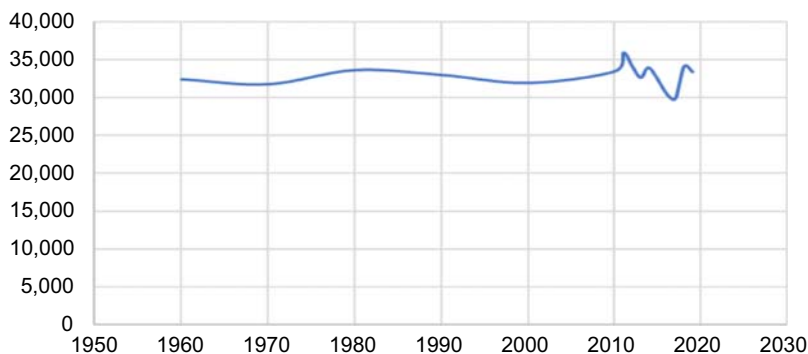

Figure 1.5 World cotton area of production '000 ha' [hectares].
From ICAC world cotton statistics 2017.

The area of world production dedicated to cotton has fluctuated since the 1960s, from 30 to 36 million hectares, with an average of 33 million hectares, as shown in Figs. 1.5 and 1.6.

The world yield has risen almost continuously since the 1960s. In the 1980s, the world cotton yield rose dramatically. It reached a record 611 kg lint cotton per hectare in the 2000s with improvements in seed varieties and the use of biotech cotton technology. In 2013, the world yield reached 800 kg lint cotton per hectare. The yield in 2018 was estimated at 788 kg lint cotton per hectare (Fig. 1.7).

The world cotton mill use was forecast to be 27.5 million tons in 2018–2019, surpassing the record of 26.7 million tons in 2007–2008, as shown in Fig. 1.8.

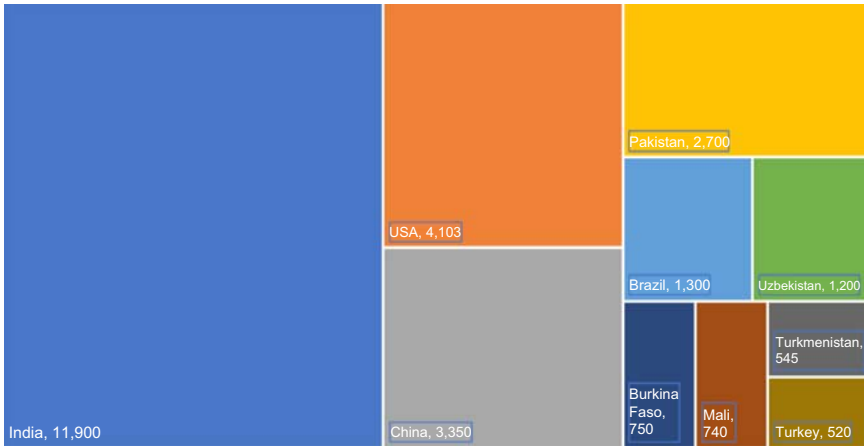

Figure 1.6 Area of cotton production by country – 2018.
From ICAC world cotton statistics 2017.

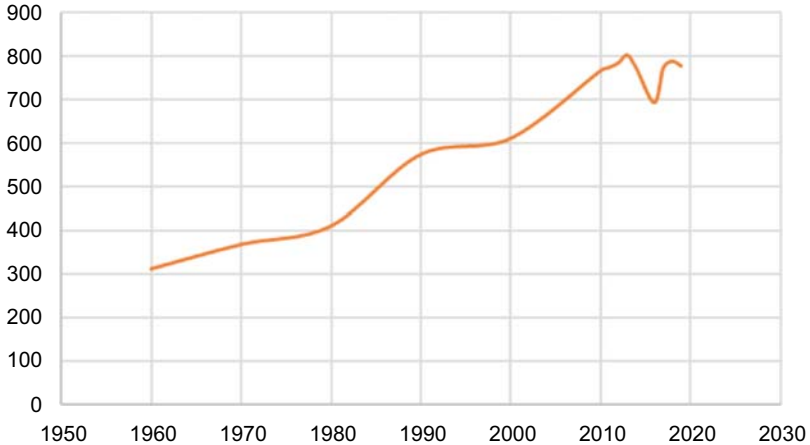

Figure 1.7 World cotton yield: kilograms lint per hectare.
From ICAC world cotton statistics 2017.

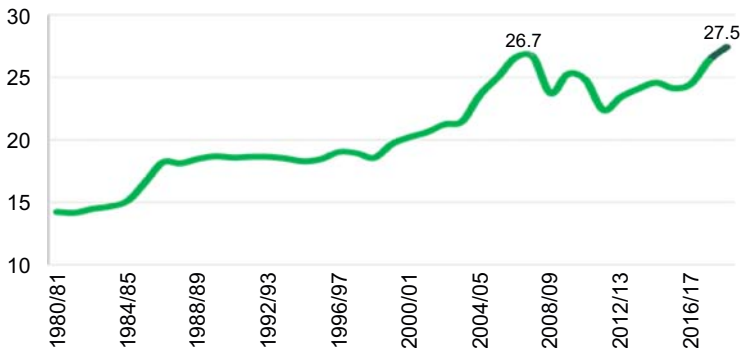

Figure 1.8 World cotton mill use.
From ICAC, Research Associated Program, Lorena Ruiz World Textile Demand – 2018.

1.2 Fibre growth development

Cotton fibre progresses through four developmental stages (Jasdanwala et al., 1977): initiation, elongation, secondary wall synthesis, and maturation. Whereas maturation occurs after boll opening and describes the drying of the mature, metabolically inactive fibre, the first three stages occur while the fibre is alive and actively growing. Fibre initiation involves the initial isodiametric expansion of the epidermal cell above the surface of the ovule. This stage may last only a day or so for each fibre. Because there are several waves of fibre initiation across the surface of the ovule (Stewart, 1975), one may find the beginnings of fibre at any time during the first 5 or 6 d after anthesis.

The elongation phase encompasses the major expansion growth phase of the fibre. Depending on the genotype, this stage may last for several weeks after anthesis. During this stage of development, the fibre deposits a thin, expandable primary cell wall composed of a variety of carbohydrate polymers (Meinert and Delmer, 1977). As the fibre approaches the end of elongation, the major phase of secondary wall synthesis starts. In cotton fibre, the secondary cell wall is composed almost exclusively of cellulose. During this stage, which lasts until the boll opens (50–60 d after anthesis), the cell wall becomes progressively thicker and the living protoplast decreases in volume. There is a significant overlap in the timing of the elongation and secondary wall synthesis stages. Thus, fibres are simultaneously elongating and depositing the secondary cell wall.

The establishment of the fibre diameter is a complex process that is governed to a certain extent by the overall mechanism by which fibres expand. The expansion of fibre cells is governed by the same related mechanisms occurring in other walled plant cells. Most cells exhibit diffuse cell growth, in which new wall and membrane materials are added throughout the surface area of the cell. Specialized, highly elongated cells, such as root hairs and pollen tubes, expand via tip synthesis in which new wall and membrane materials are added only at a specific location that becomes the growing tip of the cell.

Although the growth mechanisms for cotton fibre have not been fully documented, evidence indicates that throughout the initiation and early elongation phases of development, cotton fibre expands primarily via diffuse growth (Tiwari and Wilkins, 1995; Seagull, 1995). Later in fibre development, late in cell elongation, and well into secondary cell wall synthesis (35 d after anthesis), the organization of cellular organelles is consistent with continued diffuse growth (Seagull et al., 1998). Many cells that expand via diffuse growth exhibit increases in both cell length and diameter; but cells that exhibit tip synthesis do not exhibit increases in cell diameter (Steer and Steer, 1989). If cotton fibre expands by diffuse growth, it is reasonable to suggest that cell diameter might increase during the cell elongation phase of development (Fig. 1.9).

Cell expansion is also regulated by the extensibility of the cell wall. Regardless of whether cell expansion occurs via tip synthesis or diffuse growth, the wall in the region of expansion must yield to turgor pressure if the cell is to increase in size. For this reason, cell expansion most commonly occurs in cells that have only a primary cell

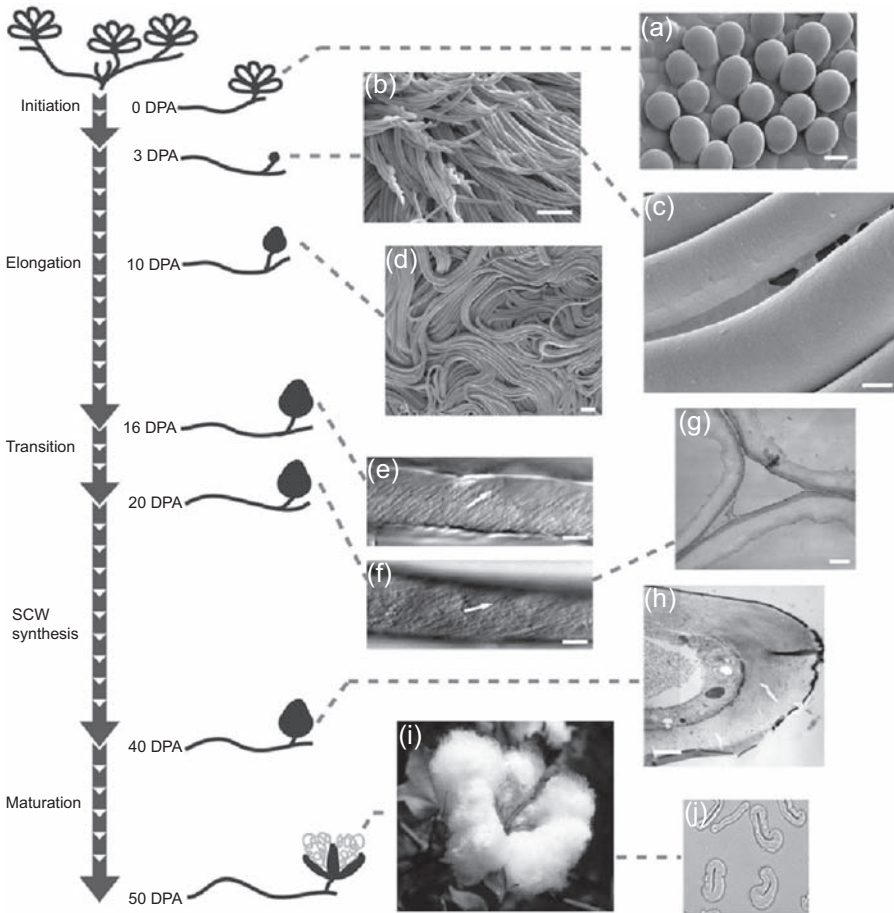

Figure 1.9 Progression of cotton fibre development. The stem indicates the fastest developmental timeline when plants are grown under warm conditions. Branches show day postanthesis (DPA) with associated images of fibre. Cryo-field emission scanning electron microscopy of (A) fibre initials on the ovule surface (bar = 10 μm); (B) twisting and elongating 3 DPA fibres (bar = 100 μm); (C) cotton fiber middle lamella stretched between two 3 DPA fibres (bar = 4 μm); (D) ordered bundles of fibres inside the boll (bar = 100 μm). Differential interference contrast micrographs indicating microfibril angle (as highlighted by *arrows*) in fibre at (E) 16 DPA and (F) 20 DPA (bars = 10 μm). Transmission electron microscopy fibre cross-sections show (G) an early stage of secondary wall thickening (bar = 300 μm) and (H) a more advanced stage of secondary wall deposition (bar = 1 μm). (I) Mature cotton boll and (J) cross-section of mature fibre viewed in the light microscope. SCW, secondary cell wall. From https://www.researchgate.net/publication/236061075_An_integrative_analysis_of_four_CESA_isoforms_specific_for_fibre_cellulose_production_between/figures?lo=1.10-10-2018.

wall (Cosgrove, 1997). Primary cell walls contain low levels of cellulose. Production of the more rigid secondary cell wall usually signals the cessation of cell expansion. Secondary cell wall formation is often indicated by the development of wall birefringence.

1.2.1 Submicroscopic structure of the secondary wall

a. Crystallinity

The secondary wall consists almost exclusively of cellulose. For years, many workers have contributed knowledge regarding the submicroscopic or fine structure of cellulose. Evidence obtained by chemical methods established that cellulose is made up largely of D-glucopyranose units with one to four linkages. The number of these units in a cellulose molecule or chain varies widely; in cotton, it was estimated at 3000–4000 units (Fig. 1.10).

In cotton fibre, cellulose is present in two states of order: crystalline (i.e. ordered cellulose) and amorphous or accessible (i.e. disordered). X-ray diffraction measures the percentage of crystalline cellulose; the remainder is amorphous. Chemical methods measure the percentage of accessible cellulose, which broadly corresponds to the amorphous; the remainder is inaccessible.

The percentage crystallinity of cellulose has been the subject of many investigations. From x-ray evidence, it was reported that 70% of cellulose in cotton fibre is crystalline whereas the remainder is amorphous.

b. Structural reversal

Whereas many plant cellulosic fibres show the presence of a fibrillar structure spiraling around the long axis of the fibre, cotton fibre is the only one that has structural reversals, because the spiral fibrils composing the first and subsequent layers of the secondary wall, show characteristic reversals. This peculiar phenomenon has attracted much research because of its relation to fibre tensile properties, because reversals were found to be weak points in fibre structure.

A structural reversal occurs at points where the direction of rotation of the cellulose fibrils about the fibre axis changes from a left-hand spiral to a right-hand one, or vice versa.

c. Convolutions

It is well-known that normally thickened cotton fibres twist or convolute when dry. The convolution is defined as the point at which the fibre twists around itself by 180 degrees. The twists, or convolutions, appear when cell loses its water of construction. The importance of this structural phenomenon stems mainly from its relation to fibre's and yarn's tensile properties.

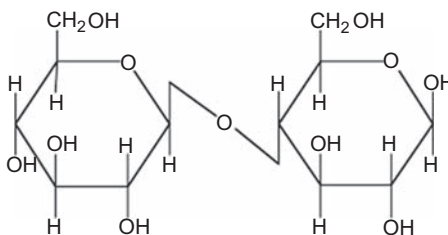

Figure 1.10 D-Glucopyranose units.

Table 1.1 Official grades of American Upland cotton (993).

Constituent	Typical (%)	Low (%)	High (%)
Cellulose	94.0	88.0	96.0
Protein	1.3	1.1	1.9
Pectic substances	0.9	0.7	1.2
Ash	1.2	0.7	1.6
Wax	0.6	0.4	1.0
Organic acid	0.8	0.5	1.0
Total sugar	0.3		
Other	0.9		

^aMoisture regained at about 8%.

1.2.2 Chemical composition of cotton fibre

The chemical composition of cotton fibre reflects its nature as a plant cell. Cellulose is the main constituent; other constituents normally present in plant cells are also present in much smaller percentages.

The structure of cotton cellulose contain a linear polymer of β -D-glucopyranose. The noncellulosic constituents of fibre are located principally in the cuticle, the primary cell wall and the lumen. Cotton fibres that have a high ratio of surface area to linear density generally exhibit a relatively higher noncellulosic content. Noncellulosic constituents include proteins, amino acids, other nitrogen-containing compounds, wax, pectic substances, organic acids, sugars, inorganic salts, and a small amount of pigments. Variations in these constituents arise owing to differences in fibre maturity, the variety of cotton and environmental conditions (soil, climate, farming practices, etc.). After treatments to remove naturally occurring noncellulosic materials, the cellulose content of the fibre is over 99% (Table 1.1).

1.3 Cotton fibre quality properties

The primary objective of determining a fibre's properties is to provide a fibre that exhibits criteria suitable for the spinning technique used by the textile mill and for the desirable level of yarn quality. The quality of cotton is not a simple criterion but rather, a complicated one. It includes numerous fibre properties that determine the field of use, the processing behaviour, the quality and the price of the end product. These properties vary widely among different cottons. The most important qualities are the fibre length, length uniformity and short fibre content, fibre strength, fibre fineness and maturity and fibre colour.

1.3.1 The role of fibre length

The length" of cotton fibres is a property of commercial value because the price is generally based on this character. To some extent it is true, because, other factors being

equal, longer cottons give better spinning performance than do shorter ones. However, the length of cotton is an indefinite quantity, because even in a small, random bunch of cotton, the fibres vary enormously in length.

According to [Deussen \(1992\)](#), fibre length is the most important quality for four reasons:

1. The yarn count that can be spun from cotton depends on its fibre length. With other properties being equal, finer yarns can generally be spun from longer cottons.
2. With other fibre properties being equal, at the same count, yarns spun from longer cotton are stronger than those from shorter cotton.
3. The fibre length has a direct bearing on yarn strength because the longer the fibres in yarn, the greater number of points of contact and cohesion between them, consequently resulting in increased yarn strength.
4. When spun into a specific count, longer cottons require less twists, especially in yarns, and consequently higher productivity for the spinning frame. Fibre length is usually associated with strength and fineness. Longer fibre cottons are usually of higher fineness and strength.

1.3.2 Length uniformity and short fibre content

Length uniformity is part of the premium or discount valuation of cotton. Short fibres are virtually uncontrolled in manufacturing, indirectly causing product defaults and directly contributing to higher waste and lower manufacturing efficiency. The fibre length and length uniformity ratio were the primary factors in determining yarn uniformity and defect levels. Short fibres are usually used as evidence of fibre breakage and negatively affect yarn uniformity. Yarn breakage is affected by fibre length and related parameters such as the staple length, the short fibre content, and length uniformity. If a fibre is shorter than a specific length, it will contribute nothing to yarn strength. As a secondary effect, an increasing number of short fibres will cause a great amount of floating fibres in the drafting zone and yarn evenness will be impaired. In the short term, yarn diameter varies by the same amount as twist and strength.

1.3.3 Fibre strength and elongation

Why does a spinner need stronger fibres? There are three reasons:

- a. Strong fibres survive the rigors of ginning, opening, cleaning, carding, combing and drafting.
- b. Short fibres are usually evidence of fibre breakage, negatively affecting yarn strength and yarn uniformity.
- c. The industry needs stronger yarns. Because fibre strength translates directly into the strength of yarn, they must possess a higher average level of strength and, most important, a lower variability of strength to cope with ever-increasing processing speeds in spinning, weaving and knitting. Easy-care performance and shrinkage control of woven cotton fabrics are commonly obtained by cross-linking (resin finish), which causes a drastic loss of strength.

1.3.4 Fibre fineness and maturity

The linear density and maturity of cotton fibres have a considerable impact on yarn quality and processing performance in textile manufacturing. The term 'maturity' is

employed to characterize the average relative thickness of the secondary fibre wall. It is commonly expressed as a percentage of mature fibres in accordance with the sodium hydroxide swelling procedure described in American Society for Testing and Materials (ASTM)-D 1442. The maturity of cotton fibres can be related to harvesting schedules, weather conditions during the growing season, disease and the incorrect use of boll openers and defoliant. In a bale of cotton, the distribution of the individual fibre wall thickness is characterized by high variability. This reflects the varying degree of maturity within the plant itself, caused by different boll positions and boll formation stages at the time of harvest.

Fibre fineness determines the number of fibres per yarn cross-section at a given yarn count. Finer fibres, those with lower linear density (in mtex), increase the number of fibres in any bundle of a specified mass. Yarn strength tends to increase as more fibres become active in sharing the load when tensile forces are applied to the yarn. The number of fibres per yarn cross-section has a considerable impact on yarn uniformity. It is well-known that the coefficient of mass variation of a stand of staple fibres is a function of the number of fibres in the structure. Yarn uniformity therefore increases with the use of finer but mature fibres. As a side effect, decreasing yarn mass variability by spinning finer cotton also reduces yarn tensile strength variation, improving efficiency in subsequent processes such as knitting and weaving (Faerber, 1990).

Within a given variety, cotton that contains more immature and dead fibres tends to form neps. This is because of the lower inherent longitudinal rigidity of those fibres. Fibre entanglement occurs in the boll but is intensified by mechanical processing in harvesting, ginning and mill preparation, primarily in opening and carding. Entanglements of immature fibres around trash and leaf particles result in low cleaning efficiency and the removal of a high amount of lint along with foreign matter.

Immature cotton produces yarn with a high number of imperfections and thus substandard textile products.

Cotton immaturity is frequently associated with irregularities in fibre length distribution. Fibre damage in processing thin-walled cotton fibres affects staple length, length uniformity, short fibre content, and related yarn properties such as tensile strength and uniformity in particular. Spinning performance is characterized by high yarn breakage frequency and low machine efficiency.

The use of immature cottons is a potential source of troubles in dyeing yarns and fabrics. Low affinity to dye chemicals observed with immature fibres results in a streaky, nonuniform fabric appearance and the frequent occurrence of undyed spots caused by neps formed by dead fibres.

1.3.5 Fibre colour

Apart from coloured cottons, white is the commonest and most prevalent commercial cotton in the world. Cotton fibre colour is one of the important quality parameters because of its association with the efficiency of the bleaching process. It is also taken in many instances to be one an indicator of fibre quality deterioration caused by weathering. However, when dealing with cotton fibre colour as a quality parameter, it is

important to differentiate clearly between two types of colour: intrinsic and extrinsic (Abdel-Salam, 1999):

(a) Intrinsic colour is defined as the inherent genuine and congenital colour determined by the genotype of the variety; it characterizes the lint of just-opened sound mature bolls before exposure to the environment's weathering factors. Intrinsic colour shades are usually removed by bleaching.

(b) Extrinsic or acquired colour is defined as the colour developed in the fibre by external weathering factors, mostly after boll opening and fibre exposure to environmental weathering such as frost, rain, microbial action and insect infestation. Extrinsic colour, or inherent discolouration, usually indicates fibre deterioration; as such, it is closely associated with cotton grading. It is difficult to remove during bleaching. From a physical point of view, colour is a sensation usually experienced as a result of light of varying wavelengths reaching the eye. Main attributes that describe the colour of raw cotton fibres are:

1. hue, which can be defined as the quality of a colour that allows it to be classified as green, blue, and so on, or an intermediate;
2. brightness, which is the lightness or darkness of the colour, and ranges from bright to dim; and
3. chroma, which is essentially the degree of intensity or saturation of a colour (or degree of yellowness).

Cotton lint colour is usually determined by visual examination. Several instruments have been developed to measure colour essentially by measuring colour reflectance. The Uster HVI was developed over 30 years of cotton classification experience worldwide. It shows, graphically and simultaneously, values for reflectance (lightness or brightness) designated as percentage reflectance (Rd %), and yellowness (chroma) designated as (+b). Rd % ranges between 40% and 90%, and +b between 0 and 20 units.

Naturally coloured cottons are marketed as specialty fibres that, to date, go through the textile manufacturing process without being dyed. The commercial availability of these cottons has inevitably raised concerns about the contamination of naturally white cotton.

1.3.6 Moisture absorption

Cotton fibre is a hygroscopic material. It absorbs water from the surrounding atmosphere and loses water to it according to its relative humidity. Because the weight of the fibre varies according to the amount of water it contains, the moisture content of cotton fibres is important from a commercial standpoint, besides its effect on processing during spinning as well as its effect on the fibre's tensile properties.

1.3.7 Fibre weathering

Environmental deterioration or weathering denotes the deleterious effect of environmental conditions on cotton fibre, resulting in its decline in quality. Environmental conditions include primarily microbiological and sunlight, and, to a lesser extent, air pollution.

As a natural organic material, cotton fibres are subjected to the degrading effects of microbes and sunlight from the moment the boll opens in the field until picking. The effect of a microbe's action continues during storage. Extended exposure to the action of sunlight and microbes could result in a loss of fibre luster and tensile properties and weight, as well as undesirable discolouration.

1.3.8 Cotton stickiness

Cotton (*Gossypium* spp.) lint stickiness is the primary cotton quality problem worldwide. It was recorded as early as 1942 and was accorded recognition as one of the most serious quality problems in the cotton industry beginning in the early 1970s. Selective insecticides can suppress honeydew-producing insects, but insecticide resistance is a continuing threat.

Adherence of contaminants and lint to cotton processing equipment is called 'stickiness', and the contaminated lint is 'sticky cotton'. Sticky cotton is a global problem that has increased as cotton processing machinery has become more refined because high-speed, large-volume processing of lint requires cleaner cotton. Honeydew, the sugar-containing excretions of certain insects, mainly whiteflies and aphids, is the most frequent cause of sticky cotton.

1.3.9 Fibre testing

The most modern methods used to test cotton fibre properties are HVI" and the Advanced Fibre Information System (AFIS" introduced by Uster.

1. High Volume Instrument

HVI was developed for the USDA in 1969. It was designed to be used as a marketing tool with which to evaluate the quality of fibre within a bale of cotton. HVI evaluates multiple fibre characteristics in a high volume of samples at a relatively high rate of speed compared with to hand classifying.

HVI uses automated sampling techniques and measures fibre properties from a bundle of fibres. This system remains popular today for both marketing and breeding because it is efficient in terms of time and cost.

2. Advanced Fibre Information System

The development of AFIS was the result of cooperative efforts between the USDA Agricultural Research Service at Clemson, SC and Schaffner Technologies, with research beginning in 1982. A primary objective in the early design of this instrument was the ability to measure trash and neps. This was followed by efforts to measure fibre dimensions, the number of short fibres, and eventually the complete fibre length distribution. These properties were chosen because of their value in the fibre-to-yarn engineering process. This basic information about the fibre is useful for quality control and production efficiency in mills, as well as for providing information needed to improve product quality.

1.4 Cotton picking

1.4.1 Handpicking

Cotton is picked from cotton bolls by hand, as shown in Fig. 1.11. Generally, workers go to the fields in the morning to start picking and work continuously until evening. Generally, a white or yellow open flower takes 50–55 days to develop to the stage at which white and harvestable lint shows.

Picking twice is generally considered good practice. In this case, the first pick is taken when 60%–70% of bolls are ready for picking; the second pick occurs later on when almost all of the leftover bolls are open. A change can be made only when the farmers find that taking two pickings is more profitable than just one.

1.4.2 Mechanical picking

1.4.2.1 Defoliation

Defoliation may be defined as the process by which leaves are abscised from the plant. The process may be initiated by drought stress, low temperatures or disease, or it may be chemically induced by topically applied defoliant agents or by overfertilization. The process helps lodged plants to return to an erect position, removes leaves that can clog the spindles of the picking machine and stain the fibre, accelerates the opening of mature bolls and reduces boll rot. Desiccation by chemicals is the drying or rapid killing of leaf blades and petioles; the leaves remain in a withered state on the plant. Harvest-aid chemicals are applied to cotton as water-based spray, by aircraft or a ground-based machine.



Figure 1.11 Handpicking in Egypt.

1.4.2.2 Mechanical cotton pickers

As the name implies, mechanical cotton pickers pick locks of seed cotton from open cotton bolls and leave the empty burs and unopened bolls on the plant. Requiring only one operator, typical modern pickers are self-propelled and can simultaneously harvest two rows of cotton at 1.1–1.6 m/s (2.5–3.6 mph). When the picker basket becomes filled with seed cotton, the machine is driven to a cotton trailer at the edge of the field. As the basket is hydraulically raised and tilted, the top swings open, allowing the cotton to fall into the trailer. When the trailer is full, it is pulled from the field, usually by a pickup truck, and is taken to a cotton gin (Figs. 1.12 and 1.13).

1.4.2.3 Mechanical cotton strippers

Mechanical cotton strippers remove open and unopened bolls along with burs, leaves and stems from cotton plants, leaving only bare branches. Tractor-mounted, tractor-pulled or self-propelled strippers require only one operator. They harvest one to four rows of cotton at 1.8–2.7 m/s (4.0–6.0 mph). After the cotton is stripped, it enters a conveying system that carries it from the stripping unit to an elevator. Most conveyers use either augers or a series of rotating, spike-toothed cylinders to move the cotton, accomplishing some cleaning by moving the cotton over perforated, slotted or wire mesh screen. Dry plant material (burs, stems and leaves) is crushed and dropped through openings to the ground. Blown air is sometimes used to assist cleaning.

1.5 Ginning mill processes and technology

The process of separating fibres from seed cotton is known as ginning. In commercial practice, this done by two group of machines: roller and saw gins.



Figure 1.12 Mechanical cotton-picking machine.

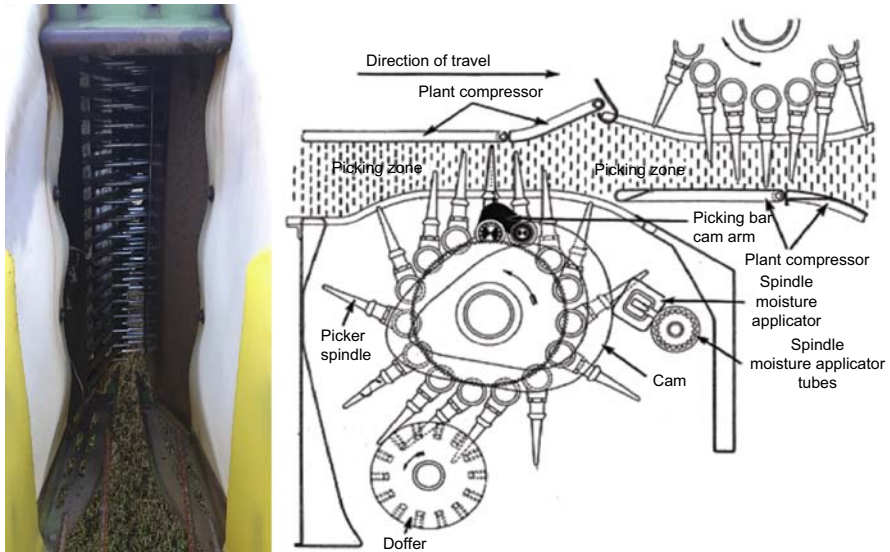

Figure 1.13 How an opposed-drum cotton picker works.

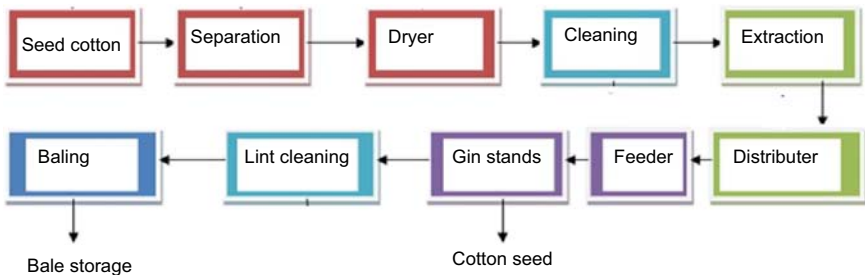

Figure 1.14 Scheme of cotton ginning.

The primary functions of a cotton gin are to condition the cotton and for seed separation and cleaning. For each metric ton of seed cotton processed, an average of 550 kg (55%) of black or fuzzy seed, 350 kg (35%) of lint, 50 kg (5%) of moisture, and 50 kg (5%) of trash and waste are extracted.

During ginning, lint dust, fine leaves and other trash are emitted. The amount of pollutants produced depends on the trash content of the seed cotton and the efficiency of the air cleaning.

The centrepiece of the lint separation process is the gin stand. However, there are seven process stages to a ginning line, as shown in the flowchart in Fig. 1.14. In addition, a properly equipped mill will have fibre testing and labeling equipment and a facility can include tools to extract seed oil.

The ginning processes of a properly equipped facility are described next.

a. Feeding

Gin machinery operates more efficiently when the cotton flow rate is constant. In early gins, the flow rate was often erratic because of the variable work rate of the person unloading the wagon. The automatic feed control was developed to solve this problem by providing an even flow of cotton to the gin's cleaning and drying system.

b. Precleaning

The next process uses mechanical devices to remove impurities such as motes (immature seeds), cotton burrs, sticks, stems, sand, dirt and similar trash from seed cotton before ginning. This process is generally combined with conditioning (drying or adding moisture).

The process machinery (such as a stick machine, cylinder cleaner and impact cleaner, cyclones and extractors) has rotating spiked drums that open the locks and clean the cotton by removing dirt and small trash. A centrifugal air pollution control device separates solid particles of the cotton boll from the seed cotton.

c. Drying and conditioning

Seed cotton should have a moisture content of 5%–6% for roller ginning. Tower driers are required to dry seed cotton. In dry weather, seed cotton may have a moisture content below the requirement for ginning; in that case, humidifiers are used to add moisture.

d. Extractor feeder

The primary function of an extractor-feeder is to feed seed cotton uniformly to the gin stand at controllable rates. The extractor feeder also performs precleaning and the gin feeder ensures that single locks of seed cotton are fed into and through the gin stand.

e. Gin stand

The gin stand removes (pulls) the fibre from the seed; it is the heart of the ginning system.

There are two generic technologies for ginning: saw gins and roller gins.

Saw gins are high-production machinery. Saw ginning is used to process upland cotton (cotton less than 1 inch to 1–7/32 inch). Saw ginning is the most prevalent type of ginning used worldwide and is used in China and the United States (for upland cotton) and in Pakistan, Brazil, Uzbekistan, West and Central Africa, Australia, Greece and Syria.

However, saw ginning is a relatively harsh process that contributes to fibre damage (increases the short fibre content, reduces uniformity and increases neps), which lowers the quality of yarn spun from saw ginned lint, especially in spinning mills equipped with modern technology (Fig. 1.15).

The saw gin is especially effective in separating hard-to-remove seeds in upland cotton (short and medium staple length). However, this type of gin cannot be used on extra-long staple (ELS) and long staple (LS) cotton because it damaged the long silky fibres.

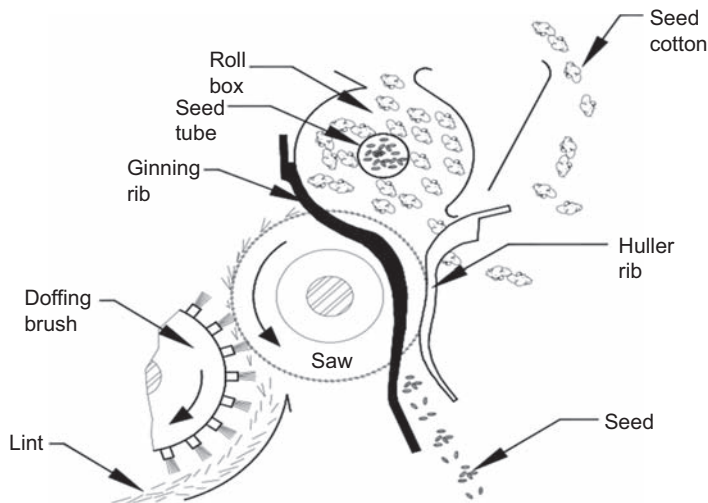

Figure 1.15 Principle of saw gin.

Standard nominal capacities for the most common types of saw gins are:

- Imperial III 116-saw (Lummus): 2000 kg (9 bales) per hour
- Imperial III 170-saw (Lummus): 3400 kg (15 bales) per hour
- Golden Eagle 201-saw (Bajaj-Continental): 4400 kg (20 bales) per hour

The rate of roller ginning production is a fraction of saw ginning productivity. Modern roller gins operate at approximately 10% of the production rate of modern saw gins. However, roller ginning technology is used for extra-fine cottons because the process preserves the length of the fibre and does not damage it.

In the separation process of roller ginning, the lint with the seed adheres to a rotating roller and the seed is pulled from the fibres by a reciprocating knife (single and double roller) or rotary knife (rotobar) (Figs. 1.16 and 1.17).

Rotary knife (rotobar) technology has superseded reciprocating knife technology because of the much higher rates of production. The modern rotobar production rate is 450 kg per hour, which is 10 times the production rate of double roller reciprocating knife machines.

For roller gins, average nominal capacities (kilograms of lint ginned per hour) for types of gin stands (as rated by manufacturers) are:

- Single roller gin: 25–35 kg of ELS lint per hour
 - Standard double roller (Bajaj): 40–60 kg of lint per hour
 - Phoenix Rotobar (Bajaj-Continental): up to 450 kg ELS and LS (2 bales) per hour
- f. Postcleaning (lint cleaning)

The lint cleaner provides the first opportunity to comb and clean the cotton fibre and separates foreign material into a separate process stream of by-products called motes.

Gins typically use two types of lint cleaners: air jet and saw. These cleaners were developed specifically for combing and final cleaning to remove foreign matter left

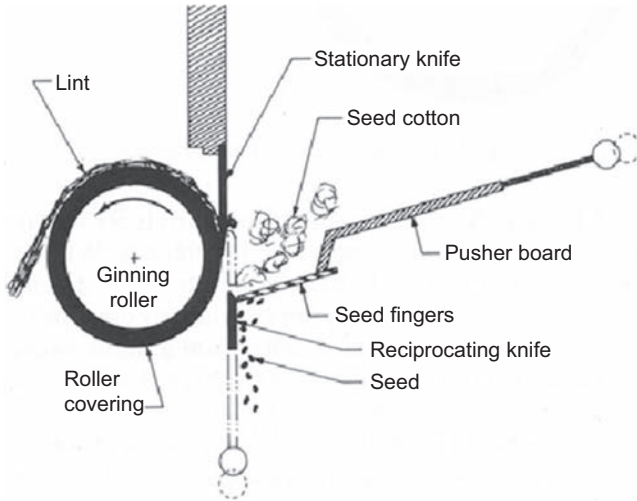

Figure 1.16 Principle of McCarthy roller gin.

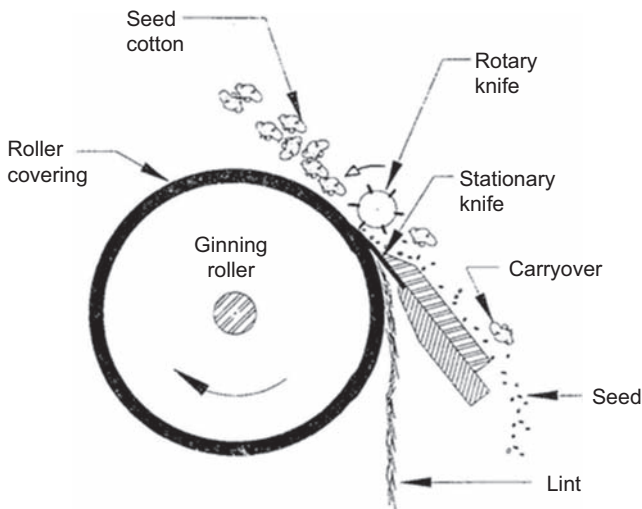

Figure 1.17 Principle of rotary knife gin.

in the ginned lint, such as small leaf particles, seed coat fragments, motes, sticks and grass. Lint cleaners can improve the grade of cotton by removing foreign matter if the cotton has the necessary characteristics of colour and preparation.

However, the fibre length and several other important quality factors can be damaged by excessive lint cleaning, especially when the cotton is too dry (<5% moisture content). To minimize lint damage to roller-ginned cotton, the lint cleaner is composed of three machines: a cylinder cleaner, an impact cleaner and an air-jet cleaner.

After ginning and lint cleaning, the combed lint is pneumatically conveyed to a condenser, which forms the cotton lint into a batt and then metres and feeds the stream of batted lint down a lint slide into the bale press.

g. Pressing and baling

The first stage of a bale press is trampers that loosely press the cotton into the press box as it is received from the condenser.

The function of the bale press is to produce uniform, compact, densely packed bales of cotton lint that go to warehouses for storage or directly to textile mills for processing (spinning) into yarn.

Cotton is baled and packaged to protect it from contamination during transportation and storage. The US textile industry standard that has been adopted universally is for bales to be packaged to a standard dimension and density of 28 lb per cubic foot (448 kg/m³). The US standard is a soft bale of 500 lb that is sufficient to support storage, handling and process uniformity throughout marketing and processing.

h. Fibre testing and labelling

Modern ginning enterprises must have at the disposal a High-Volume Instrument (HVI) for fibre quality testing. Each bale should be labelled with cotton logos and barcode for fibre quality properties.

i. Process controls

Cotton process control provides a cotton ginner with critical data, enabling the gin to process for weight and grade optimization. Process control monitors ginning process quality through a system of online sampling stations. Online measurements provide information about moisture, colour and trash for optimum processing. Process control analyzes the fibre quality and bale weight for optimum dryer temperature and cleaning practices.

1.6 Cotton classification

Worldwide, the most commonly used classification of cottons according to quality was that based on staple length. Cottons are classified into five classes or categories:

i. Short staple (SS): staple length shorter than 1 3/16 inch.

Commercially produced SS cottons belong to *Gossypium arboreum* and *Gossypium herbaceum*. Their production and consumption are largely confined to the Indian subcontinent and constitute a small proportion of total world cotton production (less than 0.5%).

ii. Medium staple (MS): staple length between 1 3/16 inches and 1 inch.

iii. Medium to LS (MLS): staple length between 1 1/32 and 1 3/32 inches. Both MS and MLS cotton belongs to *Gossypium hirsutum* and constitute most of the world's cotton production (99%).

iv. LS: staple length between 1 1/8 and 1 5/16 inches. Most varieties in this category belong to *Gossypium barbadense* and some to *G. hirsutum*, especially those of the United States known as high-quality upland.

- i. ELS: staple length 1 3/8 inches and longer.** All varieties in this category belong to *G. barbadense*; they include mainly Egyptian, American-Egyptian pima cotton” and Sea Island cotton. World production of this category constitutes a small proportion of total world production (1%), but it is regarded as the cream of the world’s cotton crop because it is superior to other cotton in length, strength, fineness, luster and other tangible properties including a large store of goodwill among textiles buyers and users.

The [International Cotton Advisory Committee \(1988\)](#) adopted a classification of world cotton based on the yarn count that could be spun from cotton lint. This classification includes six categories or types:

- a. waste/padding
- b. coarse count (yarn count 1s through 19s)
- c. medium count (yarn count 20s through 30s)
- d. high-medium count (yarn counts 31s through 40s)
- e. fine count: (yarn count 41s through 50s)
- f. extra-fine count (yarn count 51s and higher)

1.7 Cotton grading

The term ‘cotton grading’ refers to the application of official standards and standardized procedures developed by US Department of Agriculture (USDA) to measure the physical attributes of raw cotton that affect the quality of the finished product and/or manufacturing efficiency. The USDA’s classification methodology is based on both grade and instrument standards used concurrently with state-of-the-art methods and equipment to provide the cotton industry with the best possible information about cotton quality for marketing and processing. The USDA classification currently consists of determinations of fibre length, length uniformity, fibre strength, micronaire, colour, and the existence of trash, leaves and extraneous matter.

1.7.1 Grade standards

Grade standards are used for manual classification. They specify levels of colour and amount of leaves for various grade designations. The USDA maintains two types of grade standards: Universal Upland Grade Standards and American Pima Grade Standards. The USDA’s American Upland cotton standards are referred to as universal standards because they have been adopted by a special governing body and are recognized and used internationally.

The USDA has 25 official colour grades for American Upland cotton and five categories of below-grade colour, as shown in [Table 1.2](#). The USDA maintains 15 physical grade standards for American Upland cotton. Seven of the white colour grade standards also serve as official leaf grade standards for American Upland cotton. The remaining grades are descriptive.

Instrument standards refer to cottons used for **instrument** calibration and/or test level verification. These standards include Universal HVI Calibration cotton, ELS Calibration cotton, Universal HVI Micronaire Calibration cotton and Universal

Table 1.2 Chemical composition of cotton fibre^a.

	White	Light spotted	Spotted	Tinged	Yellow stained
Good middling	11-1 ^a	12	13	—	—
Strict middling	21-2 ^a	22	23 ^b	24	25
Middling	31-3 ^a	32	33 ^b	34 ^b	35
Strict low middling	41-4 ^a	42	43 ^b	44 ^b	—
Low middling	51-5 ^a	52	53 ^b	54 ^b	—
Strict good ordinary	61-6 ^a	62	63 ^b	—	—
Good ordinary	71-7 ^a	—	—	—	—
Below grade	81	82	83	84	85

All others are descriptive.

^aPhysical standards for colour grade and leaf grade.

^bPhysical standards for colour grade only.

HVI Cotton Color and Cotton Trash Standards. These standards serve the USDA and most cotton organizations worldwide as the basis for instrument cotton classification.

1.7.2 Grading of American Pima cotton

Grading procedures for American Pima cotton are similar to those for American Upland cotton, including the use of HVI measurements. The most significant difference is that the American Pima colour grade chart differs from the American Upland one. Different grade standards are used because American Pima cotton is a deeper yellow than American Upland cotton.

1.8 Cotton yarn spinning

Yarn is assemblies of fibres or filaments twisted or laid together to form a continuous strand so that it can be further processed.

Importance of fibre properties to each spinning system:

Different yarn counts will require different fibre properties. A wide range of yarn counts and twists within the same spinning system will require different fibre properties. Perhaps the best way to emphasize this is to review the principle of different spinning systems briefly from the fibre viewpoint. In principle, an SS fibre spinning cotton system consists of three basic mechanisms:

- ▶ drafting mechanism,
- ▶ consolidation (strengthening) mechanism and
- ▶ winding and package forming mechanism.

1.8.1 Spinning preparation

1.8.1.1 Blow room

Blow room is the section in a cotton spinning mill where the preparatory processes of opening, cleaning, and blending are carried out (Textile Terms and Definitions, The Textile Institute). The lint cotton arriving at the spinning mill contains various amounts of foreign matter such as seed fragments, dust and motes, all of which are called trash. To produce yarn, fibre blending has been practiced since the beginning of the cotton industry because of variations in the physical properties of cotton fibres. These variations are caused by genetic and environmental effects. In other words, these variations result from differences in varieties, soils, rainfall, irrigation practices, fertilizers, tillage methods, insect damage, the length of growing seasons, exposure of open cotton bolls before harvesting and harvesting and ginning methods. Besides these natural limitations, fibre quality variability is compounded by inherent measurement errors made by instruments and humans.

1.8.1.2 Bale blending

The most common technique for blending cotton fibres is to combine bales according to a predetermined pattern based on the fibre properties and the availability of needed qualities. The basis for selecting the bales is mainly the fibre's properties: length, grade, micronaire reading and strength. Lay-downs may vary considerably in bale number, although the more common range is from a low of 15 bales to a high of 100. The component parts of the lay-down are laid out behind the hoppers and the lay-down must be replenished continuously to maintain the continuity of the blend. With this technique, the burden of responsibility to maintain blend components proportionally constant is on the operator, although new automatic feeding weight systems, rather than volume ones, minimize the operator's influence.

1.8.1.3 Cotton carding

Carding is the process of converting tufts of entangled fibres in the scutcher lap into a filmy web by treating it between two surfaces revolving in opposite directions and at different speeds. The two surfaces are separated by a narrow setting and covered by special clothing of teeth acting opposite each other.

Objectives of carding:

- i.** Opening of cotton into individual fibres
- ii.** Removal of fine trash not removed in the blow room
- iii.** Removal of neps
- iv.** Removal of short fibres
- v.** Blending of fibres
- vi.** Production of a continuous strand of fibres (i.e. a card sliver free of twist for the next process or machine).

1.8.1.4 Cotton drawing

The drawing process is the drafting or attenuation and doubling of several slivers (six or eight) to produce one sliver.

Objectives of drawing:

- i. Straightening and parallelization of fibres to give the slivers several passages through the draw frame
- ii. Improvement of uniformity or regularity of sliver by doubling action that balances or offsets thick and thin places of doubled slivers

1.8.1.5 Cotton combing

Combing is the process of extracting short fibres, trash and neps by means of a combing machine so that a more regular, cleaner and finer yarn may be spun from cotton compared with when it is only carded.

Objectives of combing:

- i. Separation of short fibres from LS fibres so the combed fibres become more regular in length and the mean fibre length is increased, so that the movement of fibres during drafting is better controlled
- ii. Straightening and parallelization of fibres. This improves the uniformity of the arrangement of the fibres in the spun yarns, decreases fibres protruding outside the boundary of the yarn and increases the lustre of the yarn
- iii. Removal of neps and trash, enabling the production of cleaner and better-appearing yarn
- iv. Improve uniformity and strength of the spun yarn, in which the strength of the combed yarn is about 20% higher than its corresponding strength for carded yarn
- v. Enable finer counts to be spun

1.8.1.6 Roving

Roving is defined as the final pre-spinning process; it is also defined as the product of these processes. It is a continuous strand of fibres much thinner than sliver. Few twists are inserted into roving.

Objectives of roving:

- i. Reduction of weight/unit length for carded or combed sliver
- ii. Insertion of few twists to give roving the strength required to withstand handling or manipulation
- iii. Winding roving on a special bobbin to be handled easily

1.8.2 Spinning systems

Within today's technology, six main spinning systems are used by the cotton textile industry: conventional ring, compact, and open-end rotor spinning. These six systems operate based on general principles described subsequently.

1.8.2.1 Ring spinning

Much effort in breeding has been directed toward enhancing cotton fibre length, strength and fineness to promote ring spinning performance. Ring spinning is the

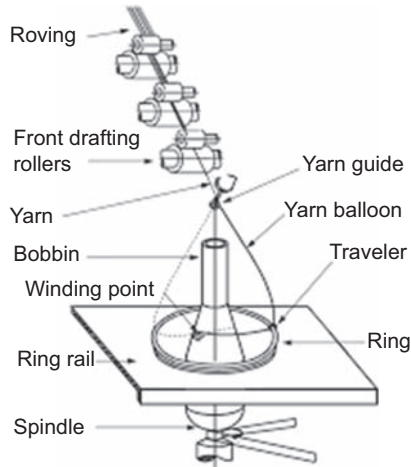

Figure 1.18 Principle of ring spinning.

oldest spinning technique available today. Thus, it has been continuously perfected since its initial development in the 19th century. Furthermore, the introduction of other types of spinning in the 20th century resulted in additional developments and innovative designs in ring spinning to keep pace with the high productivity of new systems.

El Mogahzy (1998) reported that the true market power of ring spinning lies in its unsurpassed yarn quality and its diversity. New spinning techniques can produce yarn at more than six times the linear production rate of ring spinning. However, ring spinning is the only system that can produce yarn at virtually any count from 4s to 240s and with both soft and hard twist. This may be the primary reason for the survival of ring spinning particularly in an era in which product range flexibility has become a significant economical advantage. Nevertheless, such diversity is not a result only of the spinning design, but also (and often of more importance) of the art of fibre selection (Fig. 1.18).

1.8.2.2 Compact spinning

Most of the technical advances in ring spinning aimed to improve the performance of existing technology. Compact spinning technology has been gaining interest since its first commercial introduction at International Textile Machinery Association – Paris in 1999. It can best be described as a modification of the basic ring frame and friction spinning technique (Fehrer's DrefRing development). Air current seizes the fibre as it leaves the front roller nipping line, condensing the fibre strand. The result is a dramatic reduction of the spinning triangle and better fibre alignment (Fig. 1.19).

1.8.2.3 Open-end rotor spinning

Open-end rotor spinning is the only system that offers a real challenge to ring spinning for a coarser and medium yarn count up to 40Ne. It successfully

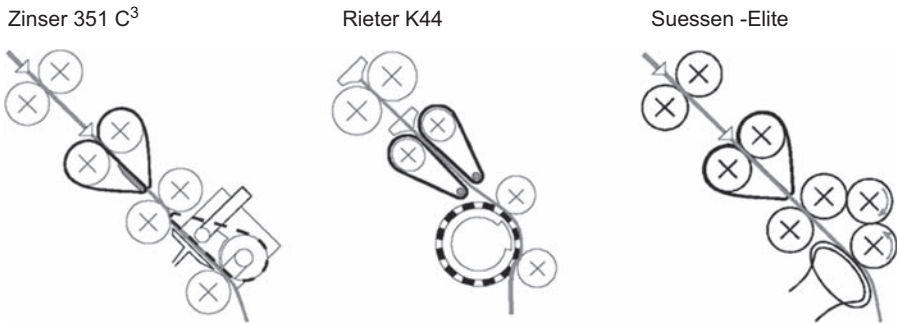

Figure 1.19 Principle of different compact spinning systems.

processes cotton at significantly higher speeds than ring spinning. Since the introduction of open-end rotor spinning, major increases in processing speeds have necessitated a reduction in rotor diameter. Open-end rotor spinning requires good fibre strength above all, because twist insertion does not take place under tension, resulting in a different yarn structure. Fibre fineness is almost equally important, because the number of fibres per yarn cross-section determines the spin limit (Fig. 1.20).

1.8.2.4 Siro spinning

In Siro spinning technology, two similar or different roving strands are fed into the drafting zone and maintained separately throughout the drafting process until the nip of the front roller, using suitable guides in the middle zone and before the delivery rollers (Fig. 1.21).

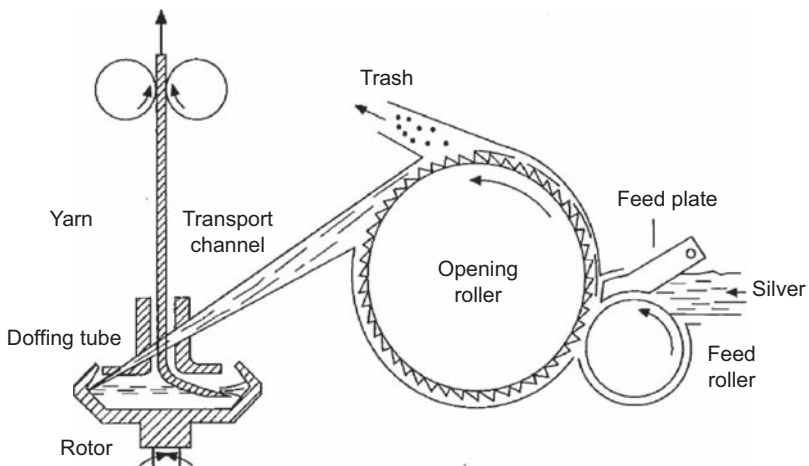

Figure 1.20 Main features of open-ended spinning system,

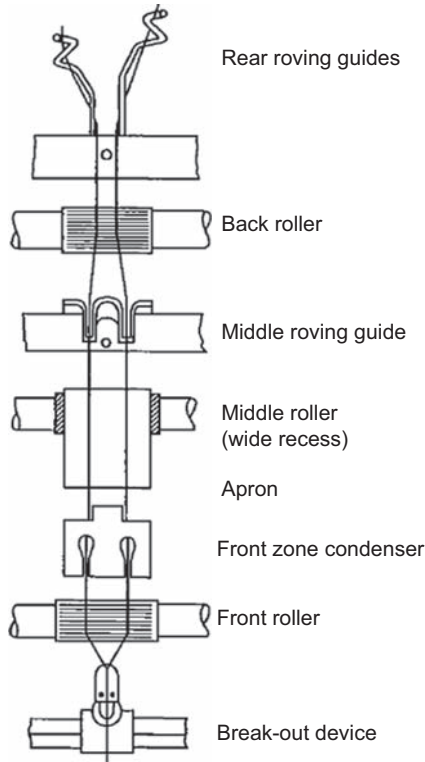

Figure 1.21 Principle of Siro spinning.

1.8.2.5 Friction spinning

Friction spinning technology since 1966 has been based on the principle of open-end spinning, which consists of the following operations:

- ▶ Feeding a sliver of fibres into the spinning system, separating the sliver into individual fibres (i.e. opening), reassembling the individualized fibres, twisting the reassembled fibres to form the yarn and winding the yarn onto a yarn package.
- ▶ The process is assisted by air suction through roller perforations. The resultant yarn is withdrawn from the nip of the friction rollers and wound on a package (Fig. 1.22).

1.8.2.6 Air jet spinning

- ▶ In Murata Vortex spinning (MVS) spinning, a finisher sliver is supplied directly to the drafting device, which is the same as Murata jet spinning (MJS). The drafted fibres are passed through an air jet nozzle and hollow spindle to make them into a yarn.
- ▶ With a high production speed (≥ 400 m/m), the MVS has the ability to spin yarns of 100% cotton as well as blends. Although the MVS yarn construction is somewhat different from MJS yarns, it still gives the same quality benefits to fabrics (Fig. 1.23).

1.8.3 Fibre-to-yarn conversion

One of the key aspects of producing a high-quality yarn is to achieve an optimum conversion of fibre properties into yarn characteristics. Nowadays, competitive market

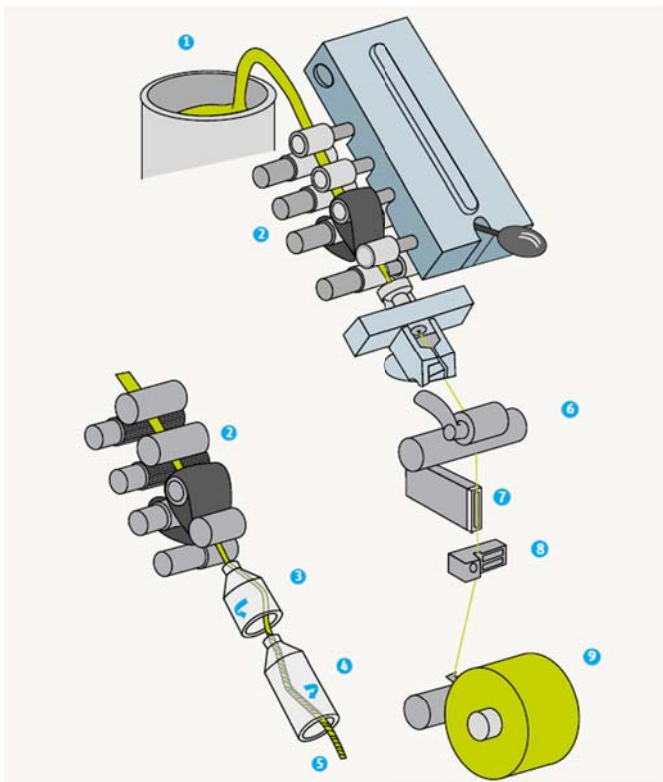
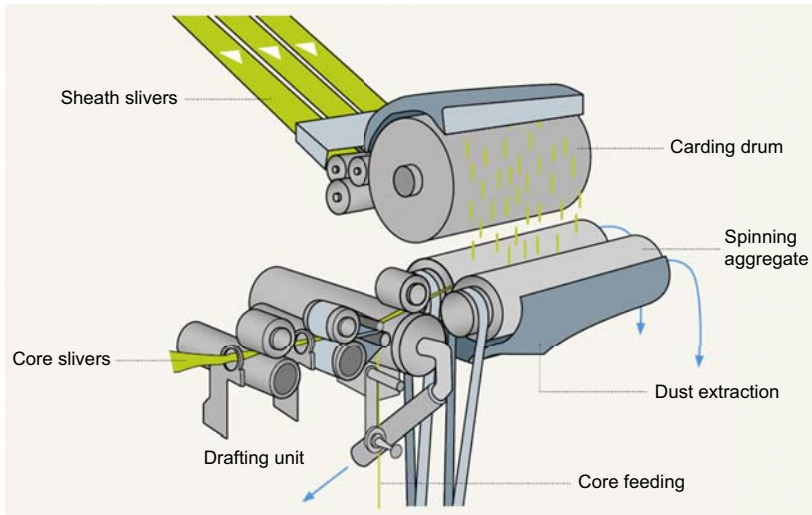

Figure 1.22 Principle of friction spinning.

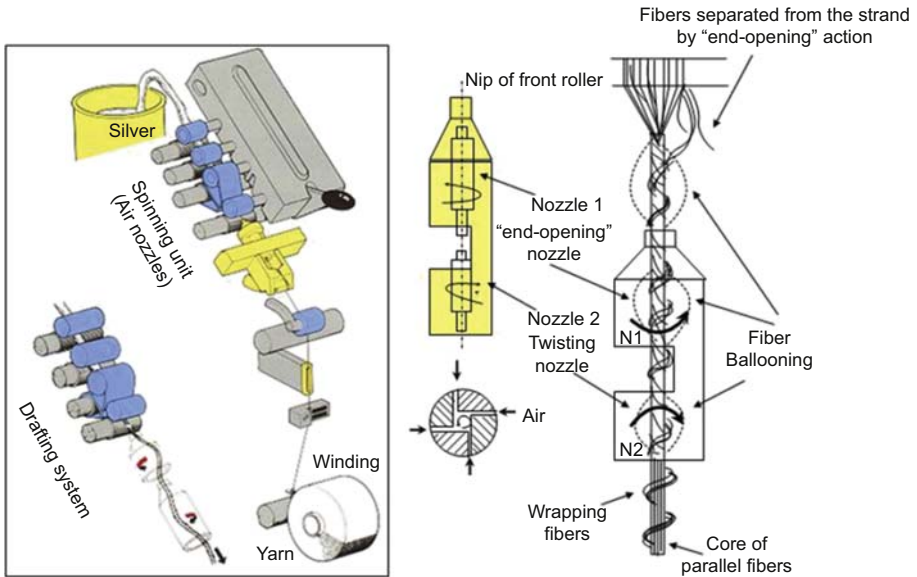

Figure 1.23 Principle of air-jet spinning system.

fibre-to-yarn conversion represents one of the secret recipes of success that can differentiate between the performance of one spinning mill and another. The two basic economic components that determine the survival and prosperity of any business are cost and revenue. The overall financial status of a spinning company depends largely on the profit that a company makes from selling the yarn. This profit can occur only when there is a positive difference between the price of yarn (the yarn value in the marketplace) and the cost of making the yarn.

1.9 Yarn testing

Cotton possesses many qualities to make it a good textile fibre. Its dominant position as a textile raw material is primarily due to its versatility for a wide range of end uses.

Testing has never been more important in the textile industry than at present, with the increasing accent and premium on high-quality products, whether for domestic markets or export trade. Important characteristics of yarn quality being tested are discussed subsequently.

1.9.1 Yarn count 'yarn linear density'

The fineness of the yarn is usually expressed in terms of its linear density or weight per unit length (count). A number of systems and units express yarn fineness and are classified as:

Direct system (English count [Ne], metric count [Nm], and French count [Nf])

Indirect system (Tex and Denier)

Ne: number of hanks of 840 yards of yarn weighing 1 lb

Nm: number of hanks of 1-km yarn weighing 1 kg

Nf: number of hanks of 1-km yarn weighing 0.5 kg

Tex: weight in grams of 1000 m (1 km) yarn

Denier: weight in grams of 9000 m (9 km) yarn

1.9.2 Yarn twist

Twist is a measure of spiral turns given to a yarn to hold the constituent fibres or threads together. Twist is generally expressed as the number of turns per unit length of yarn: for example, turns per inch or turns per metre. Twist in a yarn may be either in the S or Z direction. Strength, dyeing and finishing properties, the feel of the finished cloth, and so on depend on the twist in the yarn.

The most common term used to express a twist level is the twist multiplier, which is independent of the yarn count. It is used to compare certain yarn characteristics of yarns with different counts.

1.9.3 Yarn strength and elongation

- a. Count strength product is the force required to break the yarn in loop form formed by 80 threads, each measuring a 1.5-yard wrap.
- b. Single yarn strength is the force required to break the yarn. The rate of loading as determined by the time-to-break, which is the interval between commencing the application of the load and rupturing the yarn, is an important factor that determines the strength value recorded using any instrument.
- c. Yarn elongation is the ability of the yarn to extend under load.

1.9.4 Yarn evenness

The uniformity of a yarn is expressed by the mass variation per unit length, known as evenness.

Irregularity (U%) is the percentage mass deviation of unit length.

Coefficient of variation (C.V.)% is used in handling large quantities of data statistically.

Broadly, $C.V. = 1.25 U\%$.

1.9.5 Yarn imperfections

Yarn imperfections are classified into three categories (sensitivity levels):

- a. Thin places (−50%). When the cross-section of the yarn falls below 50% of the average value, the fault is classified as a thin place at −50% sensitivity level.
- b. Thick places (+50%). When the cross-section of the yarn exceeds 50% of the average value, the fault is classified as a thick place in three sensitivity levels (categories).
- c. Neps. When the cross-section of the yarn exceeds 200% of the average value, the fault is classified as a nep.

1.9.6 Yarn hairiness

The occurrence of short fibres and loops protruding from the yarn's surface is known as hairiness. There are two major manufacturers of hairiness testing equipment on the market. Uster hairiness (H) is defined as:

$H = \text{total length (measured in centimetres) of all hairs within 1 cm of yarn.}$

Zweigle is a less well-known manufacturer of yarn testing equipment. Unlike Uster, Zweigle does not give averages. The number of hairs of different lengths are counted separately; these values are displayed on the equipment. In addition, the S3 value is given, defined as:

$S3 = \text{sum (number of hairs } \geq 3 \text{ mm)}$

1.9.7 Yarn friction

Abrasion resistance is the ability of a fibre to withstand rubbing or abrasion it encounters in everyday use.

1.9.8 Classification of yarn faults (Uster CLASSIMAT)

There are two basic types of yarn faults. First, there are the frequent yarn faults, better known as imperfections, which are detected with an evenness tester. Second are rare yarn faults, which occur at such irregular intervals that at least 100 km of yarn has to be tested to ensure reliable detection. For open-end yarns, a test length of 1000 km is recommended. As a yarn fault classifying installation, the Uster CLASSIMAT detects all seldomly occurring yarn faults and classifies them into the respective classes of the CLASSIMAT system.

Using the CLASSIMAT matrix, it is possible to define or control the most suitable yarn clearer settings such as fault classification, fault lengths, fault sizes and fault channels of the clearers.

1.10 Weaving

1.10.1 Definition of woven fabric

Woven fabric is formed by the interlacement of warp and weft yarns.

Warp is the lengthwise direction parallel to the selvage or finished edge of the fabric.

Weft is the widthwise direction perpendicular to the selvage.

The flowchart in [Fig. 1.24](#) shows steps necessary for creating fabrics, starting from warp production.

1.10.2 Warping

The warp is the preparation of the weaving operation. It consists of passing the yarns that form the warp of the fabric, transferring them from their original holders (cones bobbins, cops, etc.) to the roller of the loom. This roller is made of threaded pipe ends, two positioned disks called flanges that determine the width over which the warps are wound.

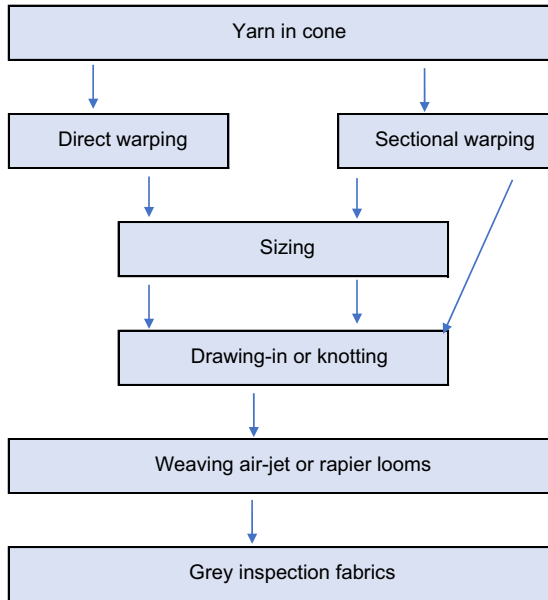

Figure 1.24 Steps necessary for creating fabrics.

The number of ends being woven is the width of the fabric being produced, the number of ends per centimetre of the yarn, and other parameters. Therefore, this number varies depending on each item to be produced.

The repass of all ends to the tear roller is not processed directly, because in this case a number of carriers equal to the number of warp threads would be required. In practice, this is not feasible, owing to the size of the structure. It would be needed to contain the media, because of operational difficulties regarding high numbers of yarns in cross-section. To overcome this difficulty, two processes were developed: sectional warp and direct warp. Although these two techniques result in the same end product (the warp roller), differences in their processing suggest certain advantages for use in accordance with the article to be produced, which determine which of the two warp systems has improved operating performance.

1.10.2.1 Direct warp

- Direct beaming is the winding of the total number of warp ends in full width in a single operation from a creeled bobbin onto either a weaver's beam or a sectional beam (Fig. 1.25).
- The system is for large-scale mass production.

1.10.2.2 Section warp

- Section warping is a two-stage machine method for preparing a warp on a beam. It consists of winding a warp in sections onto a reel and then beaming-off the complete warp from the reel onto a weaver's beam.
- The sectional warping system is used for shorter runs on high-class goods.



Figure 1.25 Direct warping machine.

1.10.3 Sizing

Sizing is a weaving preparation that aims to finish warps with a layer of a substance that binds the fibres or filaments and protects the ends from contact with the tear organs. Thus, sizing the warp involves applying a gum film on the ends, which will result in better conditions for yarn end weaving. The two most important parameters are tensile strength and abrasion resistance, so the application of sizing products in the yarn end are intended to “adhere the fibres to prevent slippage between them, increasing the tensile strength and encapsulating the ends with an elastic film so it does not lose elasticity. The sizing rollers meet the continuous warping to form with all the warp yarns of the fabric.

Sizing has the most influence on the performance of weaving. The machine combines the threads of primary rolls (continuous creel) or doors (sectional warping), applying sizing solution products. This application is usually made into a hot bath; then the yarn end is subjected to heat to return its natural moisture.

1.10.4 Leasing, knotting and drawing

Leasing must be used in direct warps (especially in high-density ends) to minimize the reversal of crossings to allow better knotting and/or drawing-in warps.

Knotting is a phase of the weaving process in which a special knotting machine is used to bind the remaining layer of yarn (finished weaving) with a new layer to be woven from a new beam while weaving with the same pattern. Through this procedure, the ends of both layers of yarn are tied one by one in order.

Drawing is the final preparation of the warp for the loom. Each thread of the warp is drawn through a drop wire, which serves to stop the loom when the thread breaks, a heald (mounted onto frames in a predetermined sequence, which during weaving are raised and lowered to create interlacing required by the fabric design), and a reed dent (the reed sets the number of threads per centimetre in the fabric and consolidates the weft pick into the fabric).

1.10.5 Weaving fabrics

Air jet dobby and rapier dobby looms are the best combination for maximum versatility in weaving sections and reducing energy costs.

Modern plants have a fully air-conditioned weaving department to attain optimum results by controlling internal and external conditions; these always affect the technical performance of machines in operation.

1.10.5.1 Weaving process

The weaving process involves interlacing two directions of thread – the warp and the weft – to make fabric or cloth. The associated machine is called the loom. It uses a jet of air or tape rapier to insert the weft. The loom ensures pattern diversity and faultless fabrics by a flexible and gentle material handling process. Fabrics can be in one plain colour with or without a simple pattern, or they can have decorative designs. They are generated from the loom with one of four basic weaves: plain weave, satin weave, twill or Jacquard loom. The fabric structure is woven by interlacing two sets of yarns perpendicular to one another in fabric form (Fig. 1.26). Yarns in the machine direction are called warp yarns or warp ends; these are interlaced with filling yarns or picks. The sequence or order of interlacing the two sets of yarns can be varied to produce many different weave designs. The finished fabric construction is determined by the number of warp and filling yarns per square inch or centimetre. The weaving process is based on projectile looms (in which the weft pick is inserted by means of a projectile) and rapier looms (in which the weft pick is inserted by means of a mechanical rapier).

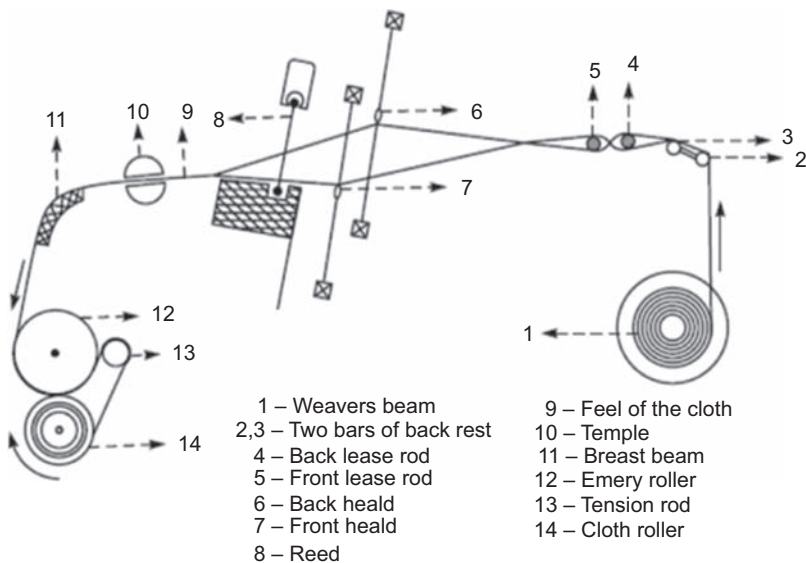

Figure 1.26 Path of warp yarn and cloth through loom.

The loom speed is measured according to the number of weft picks inserted per minute. The normal range is 200–900 picks per minute.

The weaving department strives to produce fabric that is correct according to design specifications and free from defects, ready for the subsequent process of finishing.

1.10.6 Grey fabric inspection

After weaving, 100% of fabric produced will be submitted to a close inspection to identify any defects that have occurred during weaving. The final woven fabric, wound on a cloth roll, is taken from the weaving machines at intervals and checked on inspection machines so that any weaving faults can be detected. In this quality control exercise, whenever a fault is seen, corrective measures are taken.

1.11 Terry towel

1.11.1 Definition of terry towel

The name ‘terry’ comes from the French word *tirer* which means to pull out, referring to the pile loops were out by hand to make absorbent traditional Turkish toweling. Latin *vellus*, meaning hair, has the derivation *velour*, which is toweling with cut loops. Research conducted on terry weaving by the Manchester Textile Institute concluded that original terry weaving was likely the result of defective weaving. The research indicates that this development occurred in Turkey, probably in Bursa City, one of the major traditional textile centers in Turkey. Terry weaving construction is considered a later development in the evolution of woven fabrics. Terry toweling is still known as ‘Turk fabric’, ‘Turkish toweling’ or ‘Turkish terry’.

Terry fabrics are used in various fields because of their water absorption. Piles are formed on one or both sides by the variable periodic movement of the reed or cloth fell position, mostly over three picks. According to this principle, the first two picks are beaten by the short movement of the reed some distance before the cloth fell position. In the third pick, the reed makes an exact movement, and all three picks are carried to the cloth fell position. During this movement, the three picks slide between the ground warp yarns. The pile warp yarns move forward together with three picks and take on the pile form. The distance ‘x’ shown in Fig. 1.1 corresponds to the pile length. It can be adjusted on terry weaving machines to obtain different pile heights. If piles are to be formed on the surface of a terry fabric, the pile warp yarns must be over the third and first picks; similarly, if the piles are to form on the back side of a terry fabric, the pile warps must be under the third and first picks.

Terry fabrics must be produced at a certain weight per square metre using mostly 100% cotton yarns as weft, ground and pile warp yarns. Certain yarn counts, such as Ne20/2, Ne24/2, Ne16/1 and warp density are used by factories producing terry fabrics. After the ground and pile warp yarns are prepared and drafted as one ground and one pile warp yarn, the weight per square metre of a terry fabric is adjusted by changing the pile height, or in some cases the weft density. Generally, trial and error

is used in the terry fabric industry to adjust the weight per square metre; this method is based on experience, and thus requires an experienced person to perform the adjustment. The warp density, weft density and pile height should be changed by keeping a balance among them in adjusting the weight per square metre. Otherwise, the weight per square metre, widthwise and lengthwise contractions, pile height and shearing waste of a terry fabric will not attain optimum values.

Fig. 1.1 shows the pile formation in terry fabrics with the three-pick principle. According to this principle, the first two picks are beaten by the short movement of the reed some distance before the cloth fell position. In the third pick, the reed makes an exact movement, and all three picks are carried to the cloth fell position. During this movement, the three picks slide between the ground warp yarns. The pile warp yarns move forward together with three picks and take on the pile form. Distance 's' shown in Fig. 1.1 corresponds to the pile length. It can be adjusted on terry weaving machines to obtain different pile heights. If piles are to be formed on the surface of a terry fabric, the pile warp yarns must be over the third and first picks; similarly, if the piles are also formed on the back side of a terry fabric, the pile warps must be under the third and first picks. Terry fabrics must be produced at a certain weight per square metre using mostly 100% cotton yarns as weft, ground and pile warp yarns. Certain yarn counts, such as Ne20/2, Ne24/2, Ne16/1), and warp density are used by factories producing terry fabrics.

1.11.2 Basics of terry weaving

The principles of terry weaving originated in France in 1841 by John Bright. Terry cloth is defined as a warp pile fabric with uncut loops on both sides. A fabric made from ground and pile is in the form of loops as in bath towels and bathmats. Among pile fabrics, terry fabrics are woven by a special weaving terry motion". Fig. 1.27 shows a cross-section of the pile formation for three-pick terry in which two picks are first beaten to a determined distance from the fabric fell. The third pick is then beaten against the fell together with the two preceding picks. The weft thus slips along tensioned ground warps. The pile warp ends then forms new piles.

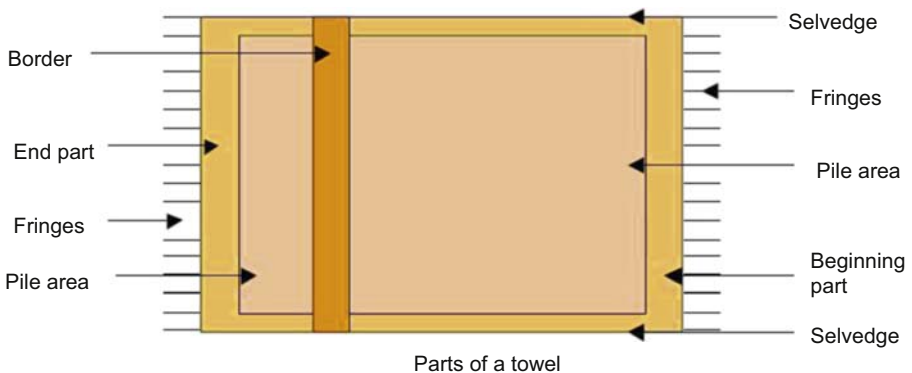

Figure 1.27 Basics of terry weaving.

1.11.3 Classification of terry towels

The classification of towels can be made according to the weight, production, and presence of the pile on fabric surfaces, the pile formation, the pile structure and finishing.

In velour towels, pile loops on one side of the fabric are sheared to give a smooth cut velvet appearance. Uncut loops of the fabric are sheared to give the best absorbency, whereas velour has a luxurious velvety hand. A towel with appliques is embellished with additional pieces of decorative fabric in a motif stitched onto the towel. Two-pick terry towels woven for bathrobes lost their importance today owing to instability of the loops. Five or more pick terry towels are rarely produced because they need to be beaten twice for each pile. Because one-sided pile toweling has low water-absorbing capacity, it is used only for special purposes such as a limited number of bathrobes. Furthermore, weaving one-sided pile terry with few or no defects is difficult. In two-sided pile terry, both sides are covered with pile, whereas all irregularities are visible in one-sided terry fabric because one side is bare without pile. Towels are divided into groups according to their end use and size as bath towels, hand towels, face towels, fingertip towels, kitchen towels and washcloths.

1.12 Knitting

1.12.1 Definition of knitting

Knitting is the process of producing fabric by transforming continuous strands of yarn into a series of interlocking loops, in which each row of loops hangs from the one immediately preceding it. Interlooping consists of forming yarns into loops, each of which is typically released only after a succeeding loop has been formed and intermeshed with it. Interlooping is the most commonly used method and is second only to weaving as the process for manufacturing textile products.

There are two main industrial categories of machine knitting: **warp knitting** and **weft knitting**. Fabrics in both of these categories essentially consist of a series of interlinked loops of yarn (Fig. 1.28).

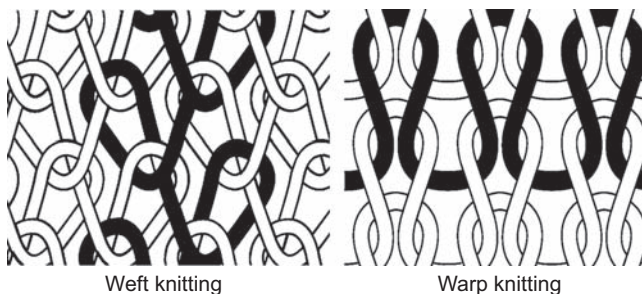

Figure 1.28 Weft and warp knitting.

Knitting was originally done by hand on straight or round needles by slipping stitches from one needle to the other and making a new stitch with each change. Hand pins of wood or plastic are used for hand knitting and crochet.

Although hand knitting continues, the main commercial product now is turned out by machine:

- Knitting machine: V-bed flat machine

Latch needles mounted in beds opposed in an inverted 'V' formation are operated by cams in a reciprocating carriage. Machines are built with E1 1/2 to E18 (needles per inch), in several centimetres (for rib trims) to about 210 cm. The V-bed flat machine is probably one of the most versatile machines for producing knitwear.

12.1. Warp knitting is the process of making fabric in which the loops are formed in a vertical or warpwise direction; the yarn is prepared as a warp on beams with one or more yarns for each needle. The fabric has a flatter, closer, less elastic knit than weft knit and is often run resistant.

12.2. Weft knitting is the most common type of knitting. It is the process of making a fabric by forming a series of connected loops in a horizontal or filling-wise direction and is produced on both flat and circular knitting machines.

- Most sweaters, cardigans and other knitted outerwear are weft-knitted fashioned garments produced with a minimum of linking from shaped, generally flat garment pieces.
- Knitting is a method of constructing fabric by intermeshing series of loops of one or more yarns.

Knitted fabric is unique in that it possesses a high order of elasticity and recovery. It can be stretched to a considerable length but will gradually return to its original shape or conformation. This feature of the fabric, plus air permeability arising from its looped structure, imparts desirable and appealing properties from the consumer's point of view:

- i. A diversity of constructions and a variety of available fibres and finishes
- ii. Generally soft and lightweight
- iii. Good drapability. Knitted fabrics conform to the figure without constricting the wearer
- iv. A high order of wrinkle resistance. Creases in knitted fabric brush right out
- v. Comfort. The knitted structure is porous and allows skin to breathe freely. Its elasticity permits greater freedom of body movement
- vi. Ease of care. Knitted apparel launders without difficulty.

1.12.2 Principle of knitting

1.12.2.1 Loop and stitch

The *loop* is the fundamental element of all knitted fabrics. It is a basic unit consisting of a loop of yarn meshed at its base with previously formed basic units (stitches). Components of a knitting loop are the needle loop and the sinker loop (Figs. 1.29 and 1.30).

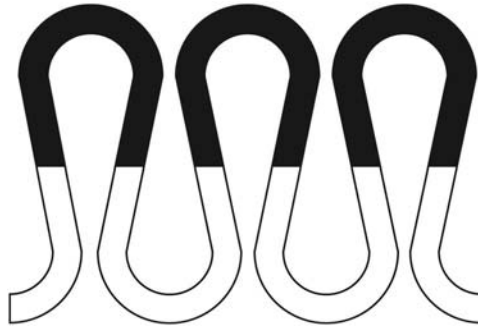

Figure 1.29 A needle loop is one that has been drawn through a previous loop.

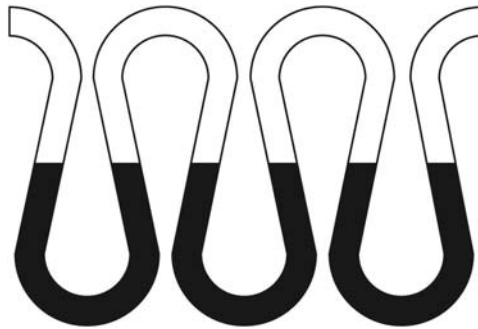

Figure 1.30 A sinker loop is one that connects adjacent needle loops.

1.12.2.2 *Stitch*

The *stitch* is the smallest dimensionally stable unit of all knitted fabrics. It consists of a yarn loop held together by being intermeshed with another stitch or other loops. There are three basic knitted stitches: knit, tuck and miss (float or non-knit), which form the starting point for the entire range of weft-knitted structure.

- Knit stitch (technical face) has a V-shape appearance in which the shanks are above and the feet below the head of the preceding stitch (Fig. 1.31).
- Purl stitch (technical back) has a semicircle appearance in which the legs are below and the feet above the head of the preceding stitch (Fig. 1.32).

1.12.2.3 *Tuck*

The tuck stitch is made when a needle rises to take a new loop without casting off the old one. It consists of a held loop and a tuck loop, both of which are intermeshed in the same course (Fig. 1.33).

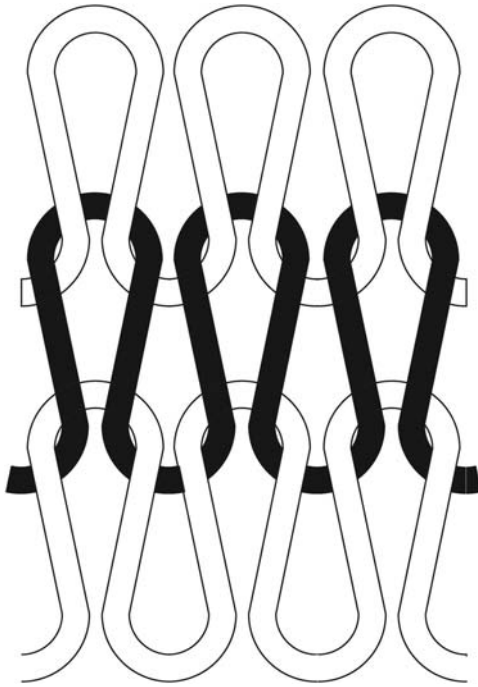

Figure 1.31 V-shape of knit stitch.

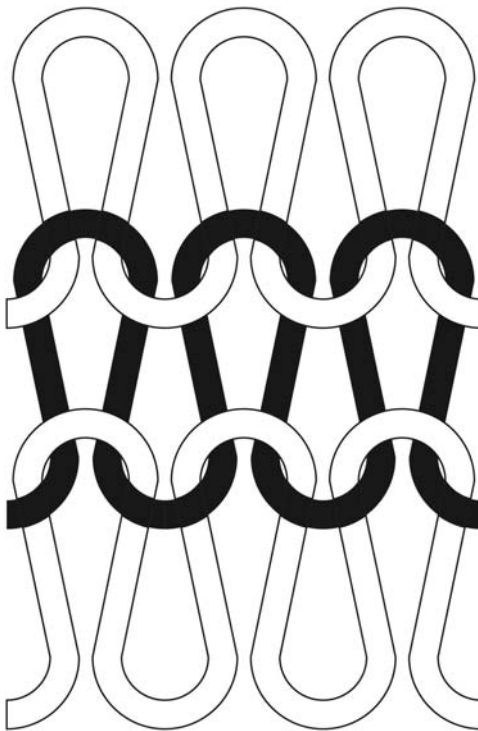

Figure 1.32 Purl stitch.



Figure 1.33 Tuck stitch.

1.13 Fabric testing

Testing is important mainly for customer satisfaction regarding the textile product, as well as to ensure product quality for the market in which the textile manufacturer competes. Testing is also important to control the manufacturing process and cost. This chapter discusses different types of testing methods for fabric.

1.13.1 Bursting strength test of fabric

A common consideration for strength parameters of textile fabrics is their bursting strength. This test is well-known within the textile trades. The ball burst test is used to test the bursting strength of fabrics. A specimen of fabric taken from either fabric rolls or a garment is placed between grooved plates of the testing equipment and fastened by means of screws. A polished and hardened steel ball attached to a pendulum actuating clamp of the machine is forced through the fabric at right angles to the fabric plane until rupture occurs. The force reading gives the bursting strength of the fabric.

Two standard methods exist for this test: one with a constant rate of traverse, whose reference standard is ASTM-D3787, and another with a constant rate of extension, whose reference standard is ASTM-D6797.

1.13.2 Tensile strength and elongation test of fabric

Fabric in garments has to bear a number of forces throughout its performance life. Thus, a fabric must satisfy a minimum level of strength to meet customer needs. The standard test involves checking more than one parameter of the fabric. For testing tensile properties, a test specimen of the fabric is clamped in the jaws of a tensile testing machine and a force is applied until the specimen breaks. The maximum amount of force exerted by the machine, recorded from the machine scale, gives the breaking force.

1.13.3 Tearing strength test of fabric

There are three methods to test the tearing strength of a fabric. The first uses a falling pendulum (Elmendorf) type tester, shown in Fig. 1.3. The tester includes a stationary clamp, a clamp carried on a pendulum that is free to swing on a bearing, and a mechanism to level, hold, then instantly release the pendulum to measure the force. The test specimen with a precut central slit is held between two clamps and the specimen is torn through a fixed distance.

1.13.4 Fabric (weight) areal density test

The fabric mass per unit area is an important consideration in selecting fabric for a particular end use. Garments made of fabric with higher areal densities are not used in the summer season, and vice versa. To determine the mass per unit area of a certain fabric, a standard specimen is prepared. This is weighed, and the results are expressed as the mass per unit area. The standard test method is ASTM-D37.

1.13.5 Air permeability

Air permeability is the ability of a fabric to allow air passage perpendicular to the fabric plane. This is an important testing requirement regarding the acceptance or rejection of commercial shipments. It is also important for garment manufacturing because fabric with too little air permeability will not allow sweat to evaporate and hence will create body irritation and odor as well as the accumulation of perspiration. Therefore, fabric may be required to pass a certain level of air permeability before it is accepted for making a certain garment.

1.13.6 Dimensional changes after home laundering

Fabric shrinkage is a prime consideration for selecting fabrics in apparel manufacturing. If appropriate shrinkage is not considered, the garment may run short on the wearer's body after washing. For that purpose, shrinkage along both the warp and weft is calculated and adjusted in garment specifications in the cutting room. The stitched garment

may appear enlarged in some dimensions, but it adapts to the original customer requirements after washing. Similarly, it is important to measure fabric elongation.

1.13.7 Bowing and skewness test of fabric

Bowing is the displacement of filling yarns (woven) or courses (knitted) from an imaginary line perpendicular to the fabric selvage. When this displacement is in an angular form, it is regarded as skewness. Bowing and skewness disturb the grain line of garment patterns and cause discomfort and improper functioning of the final garment. In addition, they diminish the aesthetics of the garment. These measurements are equally important for accepting a fabric lot.

1.13.8 Yarn slippage test

A major issue in sewn fabrics is yarn slippage. Fabrics in garments and other sewn products should exhibit sufficient resistance to yarn slippage along the seams. The test exists to determine the resistance to slippage of warp yarn over filling yarns, or filling yarns over warp yarns, using a standard seam.

1.14 Nondestructive testing

A wide variety of test schemes exist, some destructive and some nondestructive. According to ASTM E – 7, nondestructive testing (NDT) is the development and application of technical methods to examine materials of components in ways that do not impair future usefulness and serviceability, to detect, locate, measure and evaluate discontinuities and other imperfections; to assess integrity, properties and composition; and to measure geometrical and physical characteristics.

NDT has an important role in quality control not only of finished products but also of half-finished products as well as the initial raw materials. NDT can be used at all stages of the production process. It can also be used during the process of establishing a new technology by product quality or when developing a new product. Outside the manufacturing field, NDT is also widely used for routine or periodic control of various items during operation to ascertain that their quality has not deteriorated with use.

1.14.1 Application of nondestructive testing

- Fibre identification and assessment
- Light microscopy
- Fibre spectroscopy
- Colour measurement
- Fibre-optic reflectance spectroscopy
- Dye analysis
- Chromatography (ultraperformance liquid chromatography)

Successful example: Capacitive sensor to monitor fabric weight.

Capacitive sensors can be used to monitor the mass of yarns. Such a sensor is shown in [Fig. 1.34](#), which displays a parallel-plate capacitor. By putting a yarn between the plates, the dielectric relative constant values change and thus the capacity also

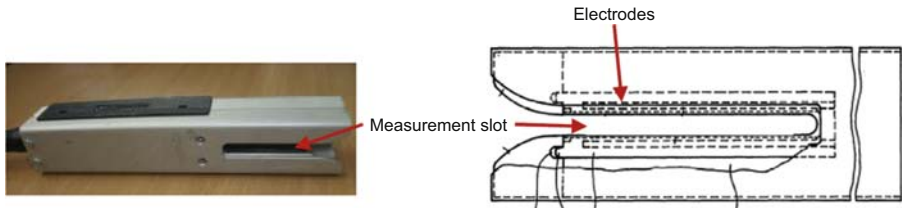

Figure 1.34 Capacitive sensor.

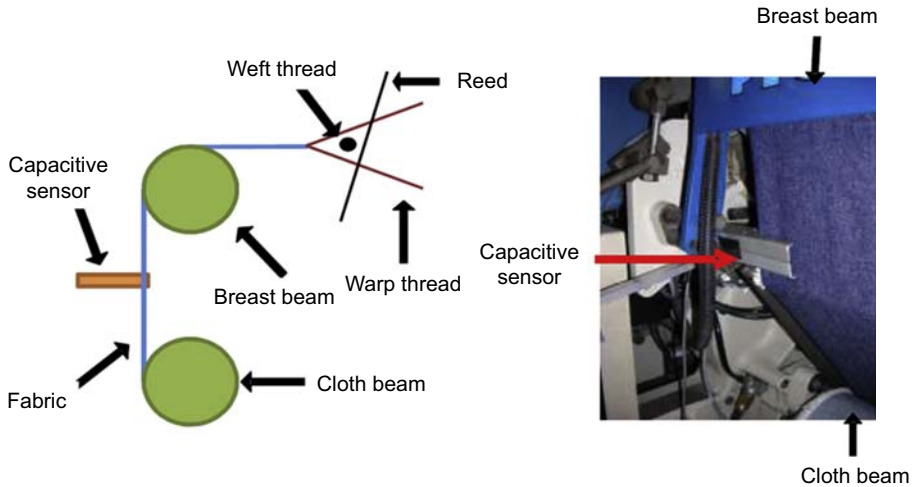

Figure 1.35 Capacitive sensor installed on a weaving machine.

changes. By doing so, [Carvalho et al. \(2003\)](#) stated that a relation is established between the capacity and the yarn's mass.

To research the functionality to monitor fabric weight during weaving, the sensor is installed between the breast beam and the cloth beam of a loom, as shown in [Fig. 1.35](#).

1.15 Conclusion

- Obtain textile fibre system

'Obtain textile fibre system' encompasses the steps of cotton cultivation, the separation of lint from cotton seeds, the production of cotton bales and the distribution of the bales for marketing. To distribute cotton bales, the transportation conduit and an assessment system will be needed.

- Turn fibre into yarn system

'Turn fibres into yarn system' involves opening the bales, eliminating impurities such as bark and leaves, parallelization, stretching and twisting the fibres, gathering the yarn produced and subsequently distributing the yarn, as shown in [Fig. 1.4](#).

- Turn yarn into fabric system

The production system 'turn yarn into fabric' is based on the knitted fabric, which can be formed by a single yarn (weft knitting) or several yarns (warp knitting). Loops are the basic constructive element of this fabric. The specification of components of this function is related to the constructive elements of the single-cylinder circular knitting machine, which produces single jersey fabrics intended for the production of T-shirts. With this machine, formation of the fabric corresponds to the action of the components: a yarn guide (responsible for guiding the yarn onto the needles) and a steel needle bed. Movement of the needles to form the fabric is performed by the set of components: cam, needles and sinker.

- Quality control testing

One definition of quality is the totality of features and characteristics of a product or service that reflects its ability to satisfy the stated or implied needs (International Organization for Standardization 8402.98).

Inspection is a crucial activity in the manufacture of textile products. Products at various stages such as upon receipt and during production and the final stage are normally inspected to assess the status of the product for acceptance or otherwise. Inspection is carried out mainly to appraise the quality of products in terms of manufacturing defects and adherence to specifications and other requirements. Normally, a visual inspection of the fabric is carried out to examine for the occurrence of yarn defects, fabric defects, design and colours in addition to specification particulars. It is followed by drawing samples for testing to determine hidden quality parameters such as shrinkage, strength, colour fastness, and so on.

1.15.1 Future trends

The Fourth Industrial Revolution, also called Industry 4.0, represents a profound change in the organizational structure of industries. For the first time, an industrial revolution is evaluated a priori and not ex post, which means a prediction of what is about to happen and not an evaluation of what has already happened (Hermann, Pentek, & Otto, 2015). Ubiquitous, mobile supercomputing, intelligent robots, genetic editing – the evidence of dramatic change is all around us and it is happening at exponential speed.

The result of the Fourth Industrial Revolution will be the intelligent factory, where cyber-physical systems (CPS), the Internet of Things and big data are the key technologies to achieving production goals. CPS are defined as physical and engineering systems that have their operations assessed, coordinated, controlled and integrated by a technology and communication center. The interconnection between cyber and physical environments will be manifested at the nanoscale and various timescales.

Sources of further information and advice

Brecher, C., *Integrative Production Technology for High-Wage Countries*, Springer Berlin Heidelberg, 2012, ISBN 978-3-642-21066-2.

Carl A. Lawrence. High Performance Textiles and Their Applications. Published by Woodhead Publishing Limited in association with The Textile Institute. Woodhead Publishing is an imprint of Elsevier. 80 High Street, Sawston, Cambridge, CB22 3HJ, UK. Copyright c 2014 Elsevier Ltd. All rights reserved.

Hildebrand, N. Capacitive sensor for detecting fluctuations in the mass and/or diameter of elongated textile test material, United States Patent, US005530368A, 25.06.1996

Raul F., Rana S. Advances in Natural Fibre Composites, Raw Materials, Processing and Analysis. ISBN 978-3-319-64640-4 ISBN 978-3-319-64641-1 (eBook)

<https://doi.org/10.1007/978-3-319-64641-1>. Library of Congress Control Number: 2017947846. © Springer International Publishing AG 2018.

The fiber year 2018. World survey on textile & nonwoven. Issued 18 May 2018.

<https://textileexchange.org/>

<https://www.trademap.org>.

www.icac.org.

www.itmf.org.

References

- Abdel-Salam, M.E., 1999. The Egyptian Cotton: Production, Quality and Marketing. Alkalema Press.
- Carvalho, V., Pinto, J.G., Monteiro, J., Vasconcelos, R.M., Soares, F.O., 2003. On-line measurement of yarn evenness, Industrial Electronics. In: ISIE '03. 2003 IEEE. International Symposium on, vol. 2, pp. 1059–1064.
- Cosgrove, D.J., 1997. Relaxation in a high-stress environment: the molecular basis of extensible cell walls and cell enlargement. *Plant Cell* 9, 1031–1041.
- Deussen, H., 1992. Improved Cotton Fibre Properties-The Textile Industry's Key to Success in Global Competition. "Cotton Fibre Cellulose: Structure, Function and Utilization" Conference. Savannah, Georgia.
- El Mogahzy, Y., 1998. Cotton Blending: How the EFS® System Can Help in Producing Optimum Yarn Quality. Engineering Fibre Selection Conference. Cotton Incorporated, USA.
- Faerber, C., 1990. FMT measurement in mill practice: importance, specific problems, corrective action. In: Beltwide Cotton Conferences, Las Vegas, Nevada – January 13.
- Hermann, M., Pentek, T., Otto, B., 2015. Design principles for Industrie 4.0 Scenarios: a literature review. Working Paper n.01/2015. Technische Universität Dortmund 15.
- International Cotton Advisory Committee, 1988. Cotton Production by Type", 47th Plenary Meeting, Lim, Peru.
- Jasdanwala, R.T., Singh, Y.D., Chinoy, J.J., 1977. Auxin metabolism in developing cotton hairs. *J. Exp. Bot.* 28, 1111–1116.
- Meinert, M.C., Delmer, D.P., 1977. Changes in biochemical composition of the cell wall of the cotton fibre during development. *Plant Physiol.* 59, 1088–1097.
- Seagull, R.W., 1995. Cotton fibre growth and development: evidence for tip synthesis and intercalary growth in young fibres. *Plant Physiol. (Life Sci. Adv.)* 14, 27–38.

- Seagull, R.W., Grimson, M.J., Muehring, T.C., Haigler, C.H., 1998. Analysis of cotton fibre ultrastructure during secondary wall deposition using ultra-rapid freezing and freeze substitution. In: Proc. Beltwide Cotton Conf., San Diego, CA, p. 1367, 5–9 Jan. 1998. Natl. Cotton Council, Memphis, TN.
- Steer, M.W., Steer, J.M., 1989. Pollen tube tip growth. *New Phytol.* 111, 323–358.
- Stewart, J.M., 1975. Fibre initiation on the cotton ovule (*G. hirsutum*). *Am. J. Bot.* 62, 723–730.
- Tiwari, S.C., Wilkins, T.A., 1995. Cotton (*Gossypium hirsutum*) seed trichomes expand via diffuse growing mechanism. *Can. J. Bot.* 73, 746–757.

Further reading

- ASTM, 1984. American Society for Testing and Materials. Standards of Textile Testing and Materials, Philadelphia, Pa.
- Cotton and textile industries holding Company, 2006. Marketing and Planning Sector, (M.P.S) brochure dated 11/12/2006.

Processing of jute fibres and its applications

2

Ashis Kumar Samanta, Asis Mukhopadhyay, Swapan Kumar Ghosh
Department of Jute and Fibre Technology, Institute of Jute Technology, University of Calcutta, Kolkata, West Bengal, India

2.1 Jute fibre

Jute is an important but coarser natural fibre mainly used for packaging and other diverse textile and non-textile applications including technical textiles. Jute is also used nowadays for furnishing and decorative upholstery products as home textiles (Cook, 1993). Jute is a ligno-cellulosic, multicellular bast fibre and is mainly cultivated in India, Bangladesh and its subcontinent (Ghosh et al., 1994; Gulrajani and Gupta, 1992a,b). Jute fibre is agro-renewable, biodegradable and easily available at low price, besides its technical advantages like high tensile strength, initial modulus, moisture regain, good sound and heat insulation property, dimensional stability and good dye acceptability. It has some drawbacks too, like relative coarseness, brittleness, harshness in feel, wide variation in fibre length and fineness with, branching nature, poor washability, and proneness to yellowing under exposure to sunlight. Low extensibility of jute is sometimes advantageous and sometimes disadvantageous too (Moses et al., 1999). Chemically the major constituents of jute are cellulose (54%–60%), hemicellulose (20%–24%) and lignin (12%–14%).

Thus Jute is the common name given to the fibre extracted from the stem of plants belonging to the botanical genus *Corchorus*. The genus *Corchorus* (Family: Tiliaceae) includes about 40 species distributed throughout the tropics. From all the species of *Corchorus*, *C. capsularis* Linn and *C. olitorius* Linn were selected by man in the wake of civilization as economic plants and are commercially important. Other species found wild in nature include *C. capsularis* also known as ‘White’ jute and *C. olitorius* known as ‘Tossa’ jute (Atkinson, 1965; Kundu et al., 1959). India, Bangladesh, China, Nepal, Myanmar and Thailand are the major producers of raw jute fibre; these countries possess conducive agro-climatic and socio-economic conditions that are suitable for the production of jute. India alone, accounts for more than 50% world production of jute (Jute et al., 2003; Indian Jute, 2005).

Over the last 3 decades, some important changes have occurred in the world consumption pattern of jute goods. Since the advent of light-weight synthetic fibres, particularly the polyolefin fibres [high density polyethylene (HDPE) and polypropylene (PP)], having some advantageous properties (Synthetics, 1969; Comparative Study, 2000; Committee on Commodity Problems, 1990) and much favourable cost structure, jute has been facing stiff competition and it has become difficult for jute

to hold its market share in the traditional application areas of packaging and carpet backing. The non-environment friendly nature ([Comparative Study, 2000](#); [Committee on Commodity Problems, 1990](#)) of most synthetic fibres, particularly polyolefins and polyester textiles stand against their continued use. Polyester and polyolefins being most destructive element to the environment for its non-biodegradable nature and catastrophic role of these synthetic fibres in ocean including formation of microplastics particles contaminated in ocean from gradual washing out liquor of these synthetics. From energy consumption point of view, manufacture of all these synthetic fibres are highly energy consuming processes leaving notable carbon emission (not favourable from carbon footprint point of view as compared to production of jute or cotton fibres) during its production from petro chemicals (a slow depleting energy re-source).

This is why, the growing consciousness regarding environment preservation has changed the situation in the recent years attracting consumers towards more and more uses of natural fibres. Some major plus points regarding jute as a natural bast fibre in this context are its agro-origin, annually renewability, soil friendly organic criteria and complete biodegradable nature (as stated earlier besides reduction in carbon emission and lower energy consumption in its production) and also its coarse nature with good tensile strength and modulus, high stiffness and shape retention, low extensibility and good sound and thermal insulation (for hollow lumen in multicellular jute), have made jute textiles much suitable for its application in Packaging textiles (Pack-tech), Geo-textiles (Geo-tech), Agricultural textiles (Agro-tech), Build and structural textiles (Build-textiles), Automobile-textiles (Mobil-tech), Protective textiles (Pro-tech), Eco-friendly textiles (Eco-Tech or oeko-Tech) and Home textiles (Home-tech) out of the 12 different categories of technical textiles. Thus, category-wise, the common and diversified end-uses of jute textiles are listed below in [Table 2.1](#):

Moreover, processing of jute fibres to make above said end user's different jute packaging and other diversified products (unlike cotton) consists of fibre preparation (jute batching and selection), Jute Carding, Jute Darwing, Jute Spinning and Jute warp and weft winding for Jute yarn manufacture followed by usual preparation of warp and weft for weaving for manufacture of woven jute cloth or manufacture of nonwoven sheet of jute from carded and opened web layers of jute fibres locked together by different means and machinery, followed by required preparatory chemical processing, dyeing, printing and chemical finishing and mechanical finishing and optional cutting and sewing to make final jute products. Processing of Jute fibres also suffers some non-eco-friendly process steps during its pre-spinning lubricating with Jute batching oil (a mineral oil, having some C12 to C25 aromatic cyclic compound as toxic component) or during its chemical softening, woolenization and causticization, desizing, scouring as well as during its dyeing with hazardous chemical dyes including metal complex acid dyes containing chromate, pigment printing using Fixer CCL (Melamine formaldehyde) and few types of functional chemical finishing of Jute like Cross-linking or anticrease finishing of Jute by use of dimethylol dihydroxy ethylene urea (DMDHEU) or other cyclic urea-based methylol containing cross-linking compound/resin or during Fire Retardant finishing of Jute using Tetrakis-Hydroxy-Methyl (tetra methylol) Phosphonium Chloride (THPC)-based fire retardant chemicals causing formaldehyde release problem and similarly other processes by

Table 2.1 Common uses of jute.

A	Packaging textiles (Pack-tech)	B	Other common purposes (miscellaneous)
	(i) Sackings. (ii) Hessian. (iii) Carpet backings. (iv) Webbing. (v) Carpet yarns or sale yarns.		(i) Back-liner fabric for sofa etc. (ii) Jute non-woven felt fabric as plaiding cloth (iii) Making of paper pulp from jute for high quality paper. (iv) As temporary panel fabrics (v) Jute-based canvas for painting
Diversified uses of jute			
C	Home textiles (Home-tech) (i) Decorative fabrics. (ii) Furnishing fabrics. (iii) Draperies and upholstery fabrics. (iv) Decorative handicraft items. (v) Decorative utility items. (vi) Kitchen and Gardener's apron. (vii) Fancy bags and shopping bags. (viii) Soft luggage (ix) Floor matting and carpets. (x) Shoe upper. (xi) Outer apparels/trimmings of apparels. (xii) Hat/gloves/table mats.	D	Protective textiles (Pro-tech) (i) Fire-retardant jute fabric as brattice cloth in mines (ii) Rot- resistant jute fabric as sand bags for defence purpose (iii) Water-repellent jute or jute-cotton union fabric as kitchen apron/Gardener's apron etc. (iv) Bitumin coated jute fabrics for under laid jute geo-textiles for road construction
		E	Eco-friendly textiles (Oeko-tech) (i) Food grade jute bags (ii) Aluminium foil coated food Grade tea bags
F	Geo-textiles (Geo-tech) (i) Soil saver fabrics for erosion control.	G	Agro textiles (Agro-tech) (i) Windscreen/plant-net

Continued

Table 2.1 Continued

	(ii)	Jute geotextiles for road construction/beco-drain, etc.		(ii)	Sunscreen./nets for sericulture plants and cocoons
	(iii)	Jute geotextiles for canal banks protection		(iii)	Mulching fabric.
	(iv)	Jute geotextiles for vegetation in arid zones		(iv)	Sleeve for plant saplings, etc.
H	Build textiles (Build tech)		I	Auto-mobile-textiles (Mobile-tech)	
	(i)	Rigid jute fibre reinforced composites with thermoset and thermoplastic polymer/resin matrix used for structural panels, separating walls, false roofing, doors, windows, venation blinds, furniture's etc.		(i)	Laminated/Coated flexible composite of jute fabrics as flexible hood or transport cover
	(ii)	Flexible jute reinforced composites for temporary tents, awnings, linoleum flooring etc.		(ii)	Automobile door panel and other automobile parts from jute-reinforced composites

using of other hazardous chemicals or additives with high BOD/COD Values etc, which need to be either eliminated or to be reduced. These newer alternative approaches for eco friendly processing including different approaches of eco friendly chemical processing of Jute textiles are discussed separately in the end of this chapter before conclusion in item no, 2.8.

2.2 Chemical composition and structure of jute fibre

Chemically, long vegetable fibres are ligno-cellulosic in nature, comprising mainly of polysaccharides and lignin. A number of minor components, such as pectin, inorganic salts, nitrogenous substance, colouring mater, wax, etc. are also found in them. Details on the chemical composition (Macmillan, 1957; Mazumdar et al., 1980) of the jute fibre is given below in Table 2.2.

2.2.1 Jute cellulose

The total carbohydrate material in jute is usually designated as holo-cellulose, which is further divided into two groups, namely, cellulose or alpha-cellulose and hemicellulose. Hemicellulose is not a homogeneous substance and generally comprises of polysaccharides of a relatively low molecular weight. The nature of association of these

Table 2.2 Average chemical composition (in percent of bone dry weight of the fibre) of jute (Mazumdar et al., 1980) [*C. Capsularis* (white), *C. Olitorius* (tossa)].

Constituents	Capsularis (white) jute	Olitorius (Tossa) jute
Cellulose*	60.0–63.0	58.0–59.0
Lignin	12.0–13.0	13.0–14.0
Hemicellulose**	21.0–24.0	22.0–25.0
Fats and waxes	0.4–1.0	0.4–0.9
Proteins or nitrogenous matter etc. (% nitrogen \times 6.25)	0.8–1.87	0.8–1.56
Pectins	0.2–1.5	0.2–0.5
Mineral Matter (ash)	0.7–1.2	0.5–1.2

*Major constituents of jute-cellulose includes glucosan (55.0%–59.0%), xylan (1.8%–3.0%) and polyuronide (% CO₂% 4) (0.8%–1.4%).

**Major constituents of jute-hemicellulose includes xylan or pentosan (15.5%–16.5%), hexosan (2.0%–4.0%), polyuronide (3.0%–5.0%) and acetyl content (3.0%–3.8%).

constituents is complex in nature and is difficult to be completely understood. Cellulose is a linear condensation polymer consisting of D-anhydro-glucopyranose units joined together by 1- 4- β -glycosidic bonds (Fig. 2.1). It has more than 50% degree of crystallinity (Cellulose, 1985).

Cellulose from different sources differ in their degree of polymerization which is possibly the single most important attribute influencing the physio-mechanical properties of this polymer. Degree of polymerization of cellulose in jute is reported to be the lowest among all the vegetable fibres (Sengupta and Dutt, 1958) and according to an estimate (Chatterjee et al., 1954) it is 1150.

Cellulose reacts as a trihydric alcohol with one primary and two secondary hydroxyl groups per glucose unit. The reactions of cellulose may be conversantly divided into the following two kinds: (i) those involving the hydroxyl groups leading to substitution, addition and oxidation and (ii) those involving glycosidic linkage leading to chain degradation by hydrolytic mechanism (Cellulose, 1985). The former type includes

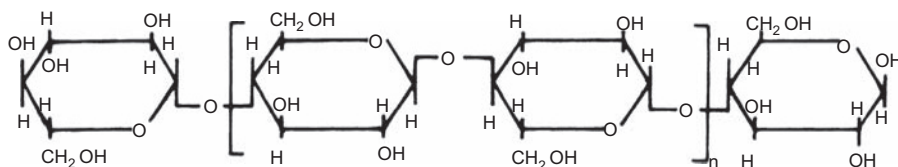
**Figure 2.1** Structure of cellulose.

such reactions as acetylation, nitration, xanthation, alkylation (etherification), etc. The degree of substitution is an important parameter in such reactions and products obtained by such modifications are seldom fully substituted. Acetate rayon and viscose rayon fibre, industrial lacquers, adhesives and thickeners are among the products obtained by such modifications of cellulose. Hydrolytic breakdown of cellulose takes place in the presence of acids, while oxidative degradation may occur in an alkaline, acid or neutral medium (Cellulose, 1985). As measured by deuterium exchange technique, the percentage accessibility of jute cellulose is reported to be lower than that of ramie, mercerized cotton and finely ground cotton (Cellulose, 1985).

2.2.2 Jute hemicellulose

Hemicellulose is composed of mainly pentosan (xylan) as shown in Fig. 2.2(a), polyuronide and a little hexosan. This is a polymeric chain of molecular substance somewhat like cellulose, but is distinguished from the latter in having a pentosan backbone with gluco-uronic acid residue occasionally attached to it and having a relatively short chain length ($DP \leq 150$) and being soluble in cold 18% aqueous NaOH solution. Jute hemicellulose (Fig. 2.2(a)) generally comprises of a number of polysaccharides of comparatively low molecular weight composed mainly of pentoses such as xylose) and uronic acid and a has low content of hexoses such as galactose and mannose.

The predominant polysaccharides in jute is composed of a backbone of β -D-xylopyranose units with every seventh unit carrying a terminal 4-O-methyl- α -D-gluconuronic

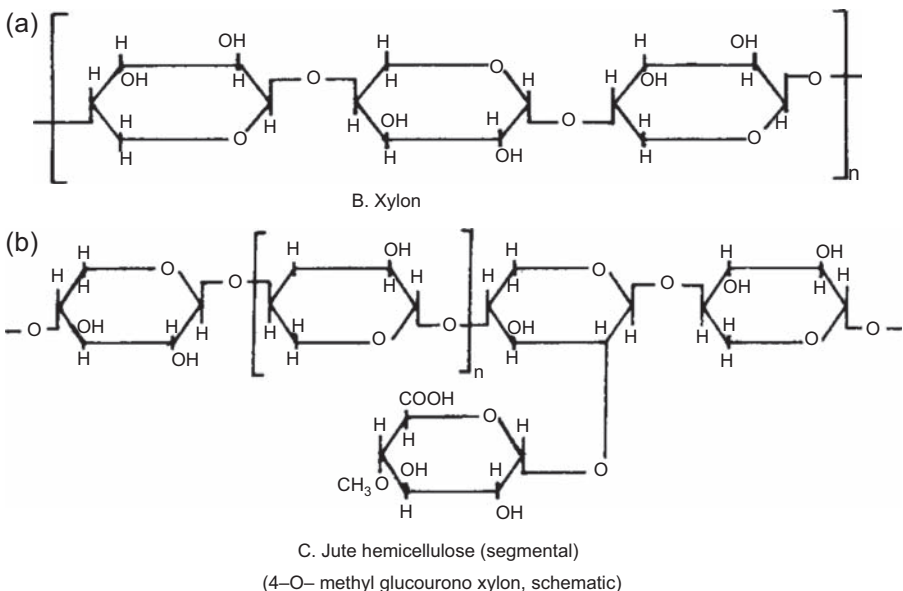

Figure 2.2 (a) Structure of Xylan. (b) Structure of jute-hemicellulose.

acid residue (Fig. 2.2(b)), linked through position C₂. Some of the xylose units in the main chain are acetylated (Aspinall and Dasgupta, 1958; Sarkar and Chatterjee, 1948a,b). The degree of polymerization (DP) of this polysaccharide, as estimated by osmotic pressure method is reported (Sarkar et al., 1948) to be low, i.e. an average of nearly 140.

The hemicellulose also possesses reducing (–CHO) end groups in a relatively less measurable concentration and is mainly responsible for the relatively strong reducing action exhibited by jute compared to native cellulose. The reducing group content as expressed by the copper number falls considerably after treatment of jute with an alkali. The hemicellulose fractions that dissolve in dilute NaOH solution at room temperature, being of fairly low molecular weight, contribute largely to the copper number of the raw jute fibre (Sarkar and Chatterjee, 1948a,b).

2.2.3 Jute-lignin

Lignin is a complex amorphous polymer which functions as the structural support material in jute plants. During bio-synthesis of plant cell-walls, polysaccharides such as cellulose and hemicelluloses are laid down first and lignin fills the spaces between them, thereby cementing them together. Lignification causes stiffening of the cell walls and the corresponding cells are thus protected from physical and chemical damage (Megregor and Greenwood, 1982) by environment and other effects. Lignin from all sources has more or less a similar composition (Sarkar, 1934, 1935, 1937). Thus, the functional groups found in lignin are; hydroxyl (alcoholic and phenolic), methoxy, dioxyethylene (–OCH₂O–), iodoform yielding complex, etc. (Sarkar, 1931). Among these, carbonyl, ether, methoxy; phenolic hydroxyl and conjugated double bonds in α -position to benzene ring in lignin structure, (Fig. 2.3(a)) attribute major chemical properties to lignin.

The structural units of lignin precursors are aromatic alcohols with a phenylpropane backbone such as, p-coumaryl alcohol, coniferyl alcohol and sinapyl alcohol (Megregor and Greenwood, 1982) (Fig. 2.3(b)).

Lignin is believed to be formed by oxidative co-polymerization of the phenylpropane units which gives large cross-linked molecules containing carbon-carbon and ether linkages (Megregor and Greenwood, 1982; Fross and Fremer, 1983). It is a short-chain, isotropic and non-crystalline material (Nodder, 1942) with a DP of about 60. High rigidity of lignin is partly due to its non-linear cross-linked structure (Gravitise and Erins, 1983). According to one source (Treatise, 1988), the molecular weight of solubilized lignin varies from 300 to 140,000 depending on the source and method of estimation.

Two types of lignin associations have been reported in jute (Sarkar et al., 1948; Rahaman, 1978; Guha Roy et al., 1984); the first kind being more easily accessible to bleaching chemicals and reagents than the other. This has been corroborated by studies on wood lignin (Gravitise and Erins, 1983), on the basis of which lignin is known to comprise of about 20% of relatively low molecular weight components (which are relatively readily solubilized and lost when treated with dilute acid or alkali), called hemi-lignin and about 80% of relatively high molecular weight components which are bound to the carbohydrate components and are called glyco-lignin.

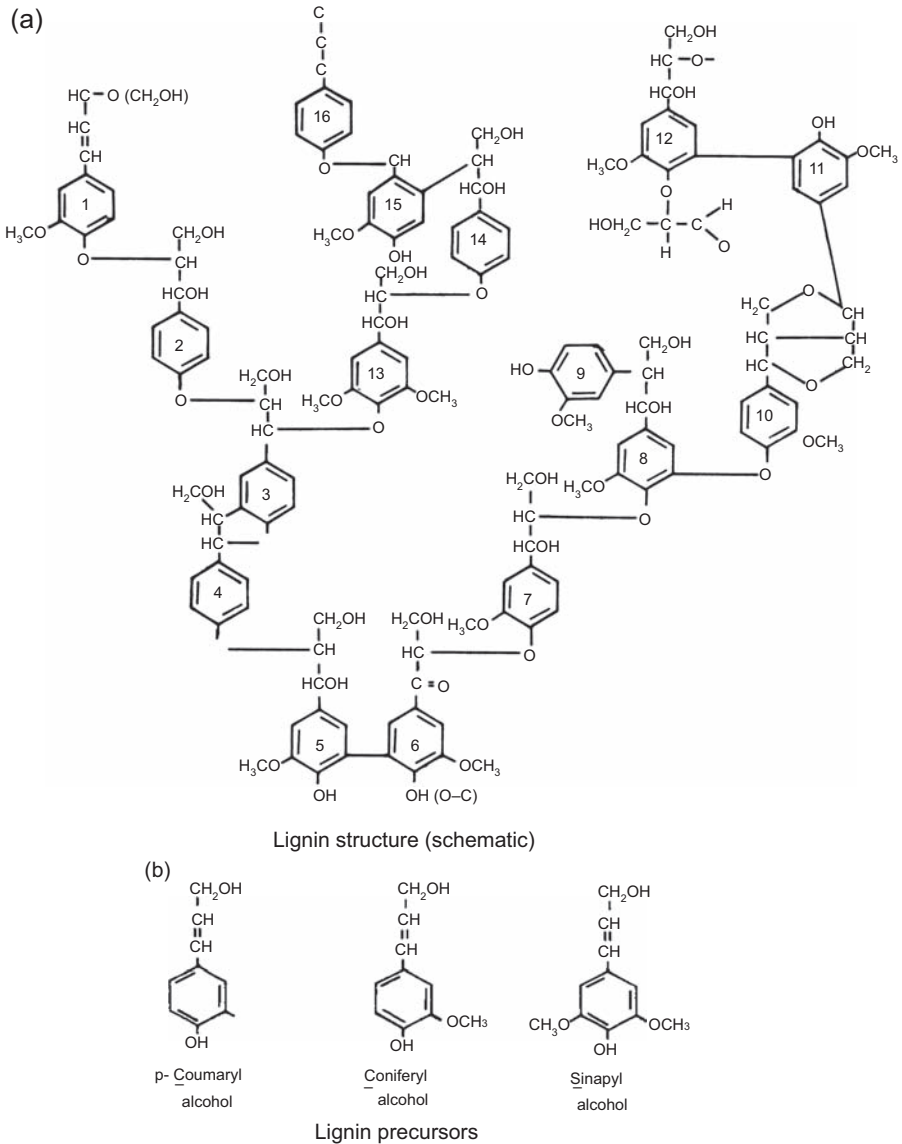

Figure 2.3 (a) Schematic structure of jute-lignin. (b) Schematic structure of lignin precursors.

2.2.4 Fats and waxes in jute

Fats and waxes (Chatterjee, 1954) are present as protective coatings on the cuticle or primary wall of cells in the jute fibre. It is soluble in organic solvents e.g. benzene and ethyl alcohol mixture. The extracted wax is greenish brown in colour. It is basically an impurity present in the jute fibre.

2.2.5 Pectins in jute

The word 'pectin' is derived from the Greek word '*pektions*', meaning jelly. A small quantity of pectin is present (Roy, 1968) in the jute fibre which holds the fibre bundles together. Pectin is a large molecule built up of repeating units called, hexouronic acid, which is a derivative of hexose sugar and undergoes decomposition during retting of the jute plant to form water soluble products through bacterial action. It has greater hygroscopicity than cellulose and swells quickly in the presence of water. However, in raw jute, there is always some residual pectin left; higher is the pectin content, higher is the stiffness of the jute fibre.

2.2.6 Inter-unit linkages in jute

Jute fibre may be considered to be a composite with the anisotropic cellulose microfibrils acting as the load-bearing entity in an isotropic lignin matrix with the hemicellulose acting as the coupling agent between the two (Cellulose, 1985). The hemicelluloses are strongly bound to the cellulose microfibrils by hydrogen bonds (Cellulose, 1985; Sarkar et al., 1948, 1947) and a portion of hemicellulose is linked to lignin hydroxyls through its uronic acid groups forming ester linkages (Sarkar et al., 1947; Das et al., 1981). It has been suggested that the $-OH$ group in the propyl side chain in the phenylpropane unit of lignin may be involved in this linkage (Megregor and Greenwood, 1982). Some of the $-COOH$ groups of hemicellulose seem to be involved in such ester linkages, while most others appear to be occupied by basic radicals like Ca^{2+} , Mg^{2+} , etc. and the rest appear as free carboxyl groups (Sarkar et al., 1947; Das et al., 1981).

De-fatted jute has been found to possess an acid value of 3.0 milliequivalents per 100 g which increases to about 12.0 milliequivalents per 100 g on rendering jute mineral-free (removal of Ca^{2+} , Mg^{2+} , etc.) by treatment with 0.1N HCl. There are different opinions about the origin of acidity of jute; an early group of investigators (Sarkar and Mazumdar, 1955; Sarkar and Chatterjee, 1948a,b) attributed this to $-COOH$ groups of hemicellulose, while a report of relatively recent origin (Das et al., 1984) attributes the free acidity of jute to the phenolic $-OH$ groups in the lignin component. However, it is believed that jute possess some acidity due to both the $-COOH$ group content of polyuronic acid residue in jute hemicellulose and phenolic $-OH$ group content in lignin residue.

Contribution of the cementing materials i.e. lignin and hemicellulose on the tensile properties of jute fibre, both in the dry and wet conditions, is enormous. It has been observed that when jute is treated with the chemical reagent employed in textile pretreatments and bleaching processes, lignin, hemicellulose and other encrusting substances are attacked and to some extent removed. The greater the extent of this removal, the more the strength of the jute fibre is diminished, particularly when the material is treated in the wet state (Treatise, 1988).

2.2.7 Physical structure and properties of jute

Jute fibre extracted by the retting process (Kundu et al., 1959; Stout, 1985) from the bast of the parent plant, which comes in the form of long mesh of interconnecting fibres commonly known as the jute reed. The jute reed is usually 6–12 feet long. Typical yield of jute fibre based on weight of stem from which it is derived, is about 6%. The top of jute reed is thinner than the root. The reeds are then split-open in carding machine into the component fibres called the spinner's fibre (Atkinson, 1965). Depending upon the six fibre quality attributes viz. bundle strength, fibre fineness, weight (length of root part over total reed weight/length) and root content, defects, bulk density, colour and lustre, the White (W) and Tossa (TD) jute are graded into eight varieties (Indian, 1987), viz. W1 (or TD1), W2 (or TD2), W3 (or TD3) and so on till W8 (or TD8), depending on Strength, Root Content, Defects, Fineness, Bulk Density and Colour and Lusture, in the descending order of their quality. Multicellular jute fibre consists of 5–30 polygonal unit cells (ultimate cell) each having a central lumen, primary/secondary cell-walls and middle lamella as shown in Fig. 2.4. For the ultimate cells of the jute fibre, the length ranges between 0.75 and 6.0 mm and the diameter ranges between 0.0051 and 0.0254 mm (Kundu et al., 1959; Treatise, 1988; Barkar, 1939a,b).

Table 2.3 illustrates the range and average of different physical and other textile related properties of the jute fibre (Jute et al., 2003; Treatise, 1988; Kaswell, 1953; Goswami et al., 1977; Meredith, 1945; Carlene, 1944; Barkar, 1939a,b; Preston, 1933; Preston and Nimkar, 1949; Bandyopadhyay, 1951; Smith, 1944; Samanta et al., 2008a,b; Basu et al., 2009; Samanta and Agarwal, 2009a,b,c). Jute fibres or filaments (also termed as spinner's fibre after carding), contain a variable number of cells; so the individual values for filament fineness and strength, within a sample, vary widely. Meshy jute fibres are gradually split up during the carding process to obtain spinner's fibre or single jute filament of variable length. The maximum length of filament in a jute yarn is about 30 cm. Specific surface area of jute fibre, as measured by air-flow technique, is about 1000 cm²/mL. Single jute filament or spinner's fibre has varied fineness, which is usually 2–2.5 tex. Thus a jute yarn having 70–80 fibres in the cross-section is about 140–210 tex (4–6 lbs/spy).

Moisture regain value of jute fibre is higher than that of cotton, viz. at 70% relative humidity, moisture regain value of jute is about 13.75%, while that of cotton is 8% or

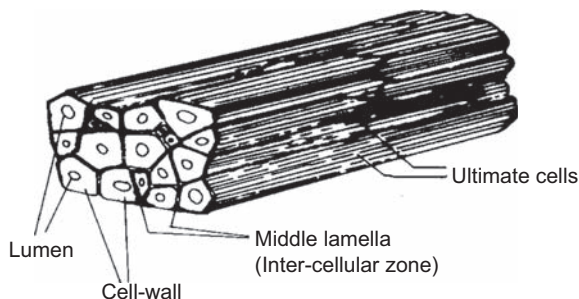

Figure 2.4 Schematic multicellular structure of jute fibre.

Table 2.3 Important physical properties of jute fibre (Treatise, 1988; Kaswell, 1953; Goswami et al., 1977; Meredith, 1945; Carlene, 1944; Barkar, 1939a,b; Preston, 1933; Preston and Nimkar, 1949; Bandyopadhyay, 1951; Smith, 1944).

Sl No.	Properties	Range
1	Length of ultimate cell (mm) (Atkinson, 1965; Nodder, 1942)	0.75–6.0
2	Width of ultimate cell ($\times 10^{-3}$) (mm)	5–25
3	Fibre fineness (linear density) (Treatise, 1988)	(tex) * 8.00–31.0 (den) **
4	Aspect ratio	110
5	Fibre density (g/cm^3) (Kaswell, 1953; Goswami et al., 1977)	1.45–1.52
6	Single fibre tenacity	(g/den)
7	Breaking elongation (%)	0.8–2.0
8	Work of rupture (g/tex) (Meredith, 1945)	0.18
9	Modulus of torsional rigidity (dyne/cm^2) $\times 10^{10}$	0.25–1.25
10	Initial modulus (g/den) (modulus at 0.1% extension)	130–220
11	Young's modulus (dyne/cm^2) $\times 10^{11}$	0.86–1.94
12	Bundle tenacity (g/den)	2.2–4.0
13	Refractive index (Preston, 1933)	
	<i>(Parallel to fibre axis)</i>	1.577
	<i>(Perpendicular to fibre axis)</i>	1.536
	<i>Bi-refringence (Double refraction)</i>	+0.041
14	(a) Swelling in water (Preston and Nimkar, 1949)	
	<i>Diametrical (%)</i>	18.0–22.0
	<i>Area-wise (%)</i>	40.0–50.0
	(b) Moisture regain (%) at 65% RH and at 27°C	12.5–13.8
15	Stiffness index (g/den)	300–400
16	Specific heat ⁴⁴ ($\text{cal}/\text{g}/^\circ\text{C}$)	0.324
17	Dielectric constant (at 50 HZ) (Treatise, 1988)	10^{14} – 10^{17}
18	Insulation resistance (KV/cm) (Treatise, 1988)	450–550
19	Heat of combustion (J/g) (Treatise, 1988)	16.0–17.0
20	Specific internal surface (m^2/g) (Treatise, 1988)	10–200
21	Coefficient of friction (<i>inclined plane method</i>) (Smith, 1944)	0.3–0.54
22	Crystallinity (%) (Treatise, 1988)	50–60
23	Copper number (Ghosh et al., 1994; Sarkar, 1934, 1935)	1.5–4.0
24	Herman's angle of orientation (degree)	7–9

*tex = weight in g of 1000 m of fibre.

**den = weight in g of 9000 m of fibre.

so. This has been mainly attributed (Samanta et al., 2008a) to the presence of hemicellulose in jute. Transverse swelling of jute fibre in water has been observed to be about 23% in diameter and it increases appreciably on removal of either lignin or hemicellulose (Guha Roy et al., 1984). With increase in relative humidity up to 70%, it follows a decreasing trend (Samanta et al., 2008a,b). Moisture absorption is reported to bring about a reduction in the degree of crystallinity of jute (Basu et al., 2009; Samanta and Agarwal, 2009a,b,c).

In addition to being mildly acidic, jute is also chemically reducing in nature. Copper number of jute (Sarkar et al., 1948) varies roughly from 1.5 to 4. Compared to cotton and ramie, jute is somewhat more resistant to the action of acid due to presence of lignin (Barkar, 1939a,b). Mild alkali such as, soda ash, borax, ammonia, etc., in cold aqueous solution, imparts a yellowish red shade to jute with almost no loss of weight. Loss of weight (about 10%), however, occurs when jute is treated at ambient temperature or boiled with aqueous soda ash solution of medium (~10%) strength (Barkar, 1939a,b).

Meaningful efforts for correct mechanical and chemical processing with jute fibres and its blends aimed at further improving/enhancing its textile related properties and energy efficient and eco-friendly processing for improving desirable textile related properties of jute products, assumes high importance in this context.

2.3 Chemical aspects and effect of chemical treatments of jute fibres

Jute is slight acidic in nature due to presence of gluco-uranoic acid residue in its hemicellulose Part and also due to phenolic hydroxyl groups present in lignin. In addition to being mildly acidic, jute is also chemically reducing in nature. Copper number of jute varies roughly between 1.5 and 4. There are many reports (Samanta et al., 2008a,b; Basu et al., 2009; Samanta and Agarwal, 2009a,b,c; Samanta et al., 2010; Samanta et al., 2014; Samanta et al., 2017a,b) on chemical treatments and modification of jute substrate to improve its properties in terms of textile related properties, processibility and dyeing including natural dyeing and functional finishing properties etc. Compared to cotton and ramie, jute is somewhat more resistant to the action of acid due to presence of lignin (Roy, 1953). Jute is very sensitive to the action of different oxidizing agents and the extent of its modification depends on the oxidizing reagents used and the conditions of reaction (Roy, 1953).

Mild alkali such as, soda ash, borax, ammonia, etc., in cold aqueous solution, impart a yellowish red shade to jute with almost no loss of weight. Loss of weight (about 10%), however, occurs when jute is boiled with aqueous soda ash solution (~10% strength) (Roy, 1953). Effects of such chemical treatment on fine structure are also evaluated and reported (Roy, 1967, 1976).

Caustic soda has a high solubilizing effect on hemicellulose and other constituents of jute. The degree of solubility generally alters with time, temperature and concentration of alkali. The effect of concentration (Roy, 1953; Macmillan et al., 1954), in this respect is marked beyond 10%. For 8%–18% NaOH, jute assumes crimps in it.

The reaction of jute with caustic soda is very rapid at the initial stage and is almost complete in 1h. About 50%–60% hemicellulose is dissolved out for use of 18% NaOH solution at 25°C. Low concentration of alkali produces softness and suppleness in jute fibre. A small portion of lignin and the whole of acetyl group are solubilized even after a mild treatment. Treatment with dilute alkali does not cause any loss of strength of jute, while that with concentrated alkali results in up to 25% loss in fibre strength (Roy, 1953; Macmillan et al., 1954).

Jute, a ligno-cellulosic multi-constituent fibre, may be viewed as a natural composite; the anisotropic crystalline/semi-crystalline cellulose microfibrils act as the reinforcing/load bearing entity whereas the isotropic, non-crystalline lignin part acts as the matrix material with hemicellulose acting as the coupling agent between the two. It is virtually impossible to limit the location of a chemical reaction on jute specifically to one particular constituent. Chemical treatment of jute may often pose a severe threat to retention of its fibre strength. Degradation effects of most chemical treatments must therefore be kept to a minimum to retain the usefulness of jute as a textile fibre. Chemical processing of jute (lignocellulose) thus differs in a major way from cotton (cellulose) in view of relatively minor presence of lignin and hemicellulose over and above the more important presence of cellulose in jute. It is therefore, necessary and also essential to develop, control and standardize chemical processing/modification of jute separately and recipe available for cotton are not exactly applicable for Jute.

The major chemical treatments of jute tried and evaluated in the past include its oxidation, reduction, alkali treatment, esterification, etherification, treatment with inorganic salts/organic compounds including some polymeric formulations and vinyl grafting, steam treatment and enzymatic hydrolysis. Bleaching and associated modifications are usually common in chemical processing of jute for obtaining improved whiteness/brightness/photostability of jute fibre with improved dyeability, absorbency along with improvement of various other property attributes of jute such as rot resistance (Chatterjee and Pal, 1952; Wilson, 1962; Barkar et al., 1981; Ghosh and Dutta, 1988), abrasion resistance (Sengupta and Radhakrishnan, 1972a,b), brightness/whiteness (Ghosh and Dutta, 1988; Ridge et al., 1944), crease recovery (Sengupta and Radhakrishnan, 1972a,b; Zahn and Das, 1965; Bhattacharjee et al., 1974; Guha, 1985; Som et al., 1987a,b; Ganguly et al., 1987), flexibility (drapability) (Sengupta and Radhakrishnan, 1972a,b), stiffness/softness (Sengupta and Radhakrishnan, 1972a,b), extensibility and bulk of the fibre (Gupta et al., 1982; Samajpati et al., 1979; Rahman et al., 1996a,b), water repellency (Sen and Dasgupta, 1974), fire retardancy (Sengupta, 1961; Gopal et al., 1985; Sharma, 1986; Banerjee et al., 1986) and compatibility (Ghosh and Ganguly, 1993; Mallick, 1988) with other natural and synthetic fibres, synthetic resins and polymers. Some discrete attempts have also been made to improve the processibility of jute and related fibres after modification of relevant fibres by selective chemical treatments. A few reports on improvement of the spinning quality of jute and allied fibres by softening them by the action of mild alkali (Das, 1958; Sikdar et al., 1993; Pringle, 1949), cationic surfactants (Roy et al., 1974) and enzymes (Ghosh and Dutta, 1980; Ghosh and Dutta, 1983; Dutta et al., 2000) are available in the literature. Further scope still remains for R&D in this area.

2.3.1 Treatment of jute with caustic soda (NaOH)

Treatment of jute with caustic soda solution is known (Roy, 1953; Macmillan et al., 1954; Saha et al., 1961; Majumdar and D, 1956; Lewin et al., 1959; Chakraborty, 1962) to bring about different types and degrees of modification in both its physical and chemical nature depending mainly on the concentration of the alkali (NaOH) used and the time and temperature of treatment. The alkali treatment of jute is commonly associated with measurable loss of hemicellulose and some marginal loss of lignin fractions (Macmillan et al., 1954; Majumdar and D, 1956). On treatment with 18% NaOH(w/w), jute fibre becomes finer and crimpy and jute fabric becomes considerably less stiff i.e. Softer with measurable shrinkage in both warp and weft direction, showing improved drapability.

However, most important changes in the characteristics of jute fibre are brought about when it is treated with strong NaOH solution (>10%) (Cellulose, 1985; Majumdar and D, 1956; Lewin et al., 1959; Chakraborty, 1962; Roy et al., 1976; Roy et al., 1983; Ganguly et al., 1985; Sao and Jain, 1984; Ganguly and Sao, 1985; Gupta et al., 1985; Sinha et al., 1988; Samanta et al., 1995; Ghosh and Samanta, 1997; Som et al., 1987a,b; Ganguly et al., 1995) at room or lower temperatures; the fibre then acquires crimp and its extensibility improves significantly from about 1% to 2% for the untreated fibre to about 5%–20% for treatment using (10%–18%) NaOH. Crimp development (texturing effect) in jute is said to be excellent on treatment with nearly 17%–18% NaOH solution at room temperature and when accomplished accordingly, the process is referred to as “chemical texturization” (Gupta et al., 1982) or “woolenization” (Saha et al., 1961) of jute. Such a process is also associated with a prominent longitudinal shrinkage of the fibre consequent to swelling of the ultimate cells and the cell walls (Cellulose, 1985; Samajpati et al., 1979; Roy et al., 1976, 1983). Majority of the crimp development using 18% NaOH at room temperature (25–30°C) is very fast initially and it goes practically to near completion within 15–30 min (Roy, 1976; Majumdar and D, 1956; Roy et al., 1976, 1983; Ganguly et al., 1985). NaOH treatment on jute may also be extended to jute blended yarns (such as jute/polypropylene, jute/cotton and jute/polyester blended yarns) to develop texturization effect (Gupta et al., 1982, 1985; Sinha et al., 1988; Samanta et al., 1995; Ghosh and Samanta, 1997) and the same may be extended to jute fabrics for speciality effects (Ganguly et al., 1995) as studied earlier.

Treatment of jute with liquid ammonia has also been reported (Mukherjee et al., 1981a,b). Liquid ammonia treatment however does not result in formation of crimp and is reported to be much less effective in improvement of extensibility of jute fibre. However, liquid ammonia treatment does not cause much weight loss or loss in strength of jute fibre, even though the process results in partial decrystallization of jute; cellulose I structure of jute-cellulose is then converted to cellulose III as this is also known to happen for cotton or viscose rayon during liquid ammonia treatment, while cellulose I is converted cellulose II during the mercerization of cotton or viscose (Marsh, 1946; Warwicker et al., 1966; Iyer et al., 1982).

2.3.2 Treatment of jute with metal salt and complexes

Treatment of jute with salts of metal such as copper, chromium, iron, manganese, zinc, antimony and cobalt done separately or in selected combinations is reported to improve its weathering resistance/rot resistance. Compounds of copper such as copper naphthenate and basic copper chromate are reported to be fairly fast to leaching (Barkar et al., 1981; Pal et al., 1964). However, fabrics so treated with metal salts, are likely to contaminate the environment during and after use when they would be made to undergo bio-deterioration. Fabric treatment as above may appear selectively undesirable on this count.

Use of diammonium phosphate (DAP), combination of DAP and ammonium sulphate/sulphamates and rochelle salt have been reported (Gopal et al., 1985; Sharma, 1986; Banerjee et al., 1986; Mondal and Roy, 1981) to render jute fire-retardant. The DAP method results in considerable loss of strength of the fabric despite it being reasonably cost-effective.

2.3.3 Bleaching/oxidation of jute and related fibres

Jute, which is pale brown in colour due mainly to the presence of lignin, can be oxidized/bleached (Ghosh and Dutta, 1988; Ridge et al., 1944; Ridge and Little, 1942; Macmillan et al., 1949; Macmillan et al., 1950; Sarkar and Chatterjee, 1948a,b; Kulkarni and Guha Roy, 1973; Chatterjee and Pal, 1955; Macmillan and Bhattacharjee, 1954; Das et al., 1952; Sengupta et al., 1958; Guha Roy and Kulkarni, 1973; Bose et al., 1973; Sikdar et al., 1973; Dickinson and Heathcote, 1972; Monograph, 1977; Ghosh and Dutta, 1987; Guha Roy et al., 1988; Tendulkar and Mandavawalla, 1991; Majumdar et al., 1994) to various degrees of whiteness ranging from pale cream to milk-white by controlled treatment with selected oxidizing agents such as calcium and sodium hypochlorite and H_2O_2 in alkaline pH and $KMnO_4$ and $NaClO_2$ under acidic conditions, peracetic acid under neutral pH, in aqueous medium. However, use of some reducing agents such as SO_2 and $Na_2S_2O_4$ for bleaching of jute has also been reported (Parsons, 1939) particularly for getting some cheaper products. Among the various bleaching methods, H_2O_2 bleaching appears to be most widely used apparently due to ready attainment of a comparatively high degree of whiteness along with a relatively low Dose of strength and weight of jute fibre employing H_2O_2 (Chatterjee and Pal, 1955; Sikdar et al., 1973; Dickinson and Heathcote, 1972; Tendulkar and Mandavawalla, 1991). Bleaching with acidic $NaClO_2$ also results in a level of whiteness that is commonly achieved with H_2O_2 ; the former causes considerable loss of weight and strength of jute fibre due mainly to measurable delignification (Kulkarni and Guha Roy, 1973; Guha Roy and Kulkarni, 1973; Monograph, 1977). Method of treatment of jute fibre with a combination of H_2O_2 and $K_2S_2O_8$ at room temperature is also reported (Pandey et al., 1995).

Bleaching of cotton and viscose i.e. purely cellulosic fibre has been reviewed nicely in a chapter of textbook of chemical pretreatment of textiles (Lewin, 1983). H_2O_2

bleaching or controlled sequential bleaching using NaOCl and H₂O₂ is very common in cotton textile industry (Lewin, 1983). Viscose rayon having low D.P. celluloses has to be bleached in a relatively mild condition using H₂O₂ (Lewin, 1983; AATCC, 1970) to avoid large scale degradation.

A relatively recent investigation reported (Ghosh and Dutta, 1987) from our laboratory relates to studies of the effect of mild oxidation of dewaxed jute using aqueous H₂O₂, KMnO₄, NaIO₄, Ca(OC1)₂ and non-aqueous Cl₂ in CCl₄ on functional group pattern, strength, whiteness index and dyeability of jute. Pre-swelling of jute with aqueous urea solution was found to enhance the rate and extent of oxidation. Rate of oxidation was the fastest using non-aqueous chlorine. Treatment with NaIO₄ solution was most effective in generation of -CHO groups, while highest concentration of -COOH group was generated on its treatment with KMnO₄ solution. Oxidation of jute by any of these methods brought about substantial improvement in dyeability of jute with a basic dye. Improvements in the whiteness index of jute however, can be best achieved by treatment with H₂O₂ and KMnO₄ the former giving a more improved product.

Per-iodate has a specific action of oxidation on glucopyranose ring of cotton cellulose. It cleaves the pyranose ring at 2-3 positions leading to the production of dialdehyde cellulose (Jackson and Hudson, 1937; Jackson and Hudson, 1938; Davidson, 1940; Davidson, 1941; Daruwalla and Subramaniam, 1958; Hard, 1955). Per-iodate does not specifically attack the glucosidic linkage leading lowering in DP of cellulose chains, if the reaction is carried out at neutral pH (Daruwalla et al., 1961).

2.3.4 Photo-yellowing or colour reversion of bleached jute

A critical drawback of bleached jute is its colour reversion or yellowing on exposure to light. Poor photostability of bleached jute is attributed (Sengupta and Radhakrishnan, 1972a,b; Ridge et al., 1944; Macmillan and Bhattacharjee, 1954; Callow, 1947; Callow and Speakman, 1949; Sengupta et al., 1960; Mukhopadhyay, 1976; Bag et al., 1984) to lignin and poor photostable nature is reported to persist down to a lignin content to little above 1%; even though the whole of the ultraviolet region of the solar spectrum contributes to yellowing of bleached jute, the most consequential region identified (Mukhopadhyay, 1976; Bag et al., 1984) corresponds to 350–355nm in UV region and the effect is continued to some distance (up to 433 nm) within the visible region also. Spectroscopic studies of lignin extract from H₂O₂ bleached jute revealed that carbonyl and cinnamaldehyde types of linkages present in lignin part of bleached jute are mainly responsible for the photo-yellowing effect (Sengupta and Radhakrishnan, 1972a,b; Ridge et al., 1944; Mukhopadhyay, 1976; Bag et al., 1984; Banerjee et al., 1985).

2.3.5 Stabilized bleaching of jute

Methods of bleaching of jute were then developed (Sengupta and Majumdar, 1967) to impart improved photostability or lightfastness of bleached jute fabrics on controlled and selective removal of lignin from the fabric surface prior to H₂O₂ bleaching. Treatment with acidic NaOCl solution/chlorine gas (Monograph, 1977; Sengupta and Majumdar, 1967), acidified KMnO₄ (FRL, 1968), and some chlorinated derivatives

of cyanuric acids are potential agents for controlled removal of lignin, particularly from the surface of jute fabrics. However, these methods found little favour with the relevant industry due to various reasons, cost considerations being most important among them. Recently, some efforts have been made to study the effect of use of various antioxidants, UV absorbers and some other approaches (like NaBH_4 treatment (Callow and Speakman, 1949) etc.) for improving photostability of jute (Abdullah and Miles, 1984; Farouqui and Hossain, 1990a,b,c,d; Achwal and Sinkar, 1993; Achwal and Sinkar, 1994). Benzotriazole has been found to be effective UV absorber for Jute having good protection of photo-yellowing (Samanta et al., 2009a,b,c).

2.3.6 Treatment with glycols

In a relatively recent investigation, Ghosh and Das (2000, 2002) studied the effect of modification of jute and cotton yarn/fabric by chemical treatments using ethylene glycol and polyethylene glycols of different molecular weight in the presence of $\text{Al}_2(\text{SO}_4)$ as the catalyst. Controlled prior oxidation of cellulosic chain molecules of jute and cotton to dialdehyde and related moieties with the help of aqueous NaIO_4 produced optimum effects considering improvements in property parameters viz., tenacity, elongation, feel and wrinkle recovery with retention of flexibility.

2.3.7 Enzyme treatment

Enzymes (Sharma, 1993) are proteins which catalyze specific chemical reactions and are known as 'bio-catalysts'. Enzymes are designed for acting in living cells, hence, they can work at atmospheric pressure and in mild conditions of temperature and pH. Their optimum activity, however, depends on the type of enzyme and process where it is applied. Significantly higher reaction rates, at surprisingly lower energy consumption can be achieved by enzyme catalysts. Enzymes can bring about hydrolysis, oxidation, reduction, coagulation and decomposition. Most common enzymes affect hydrolysis. Enzymes are highly substrate specific. The efficiency of an enzyme-catalyzed reaction depends upon the following factors: enzyme concentration, substrate nature and concentration, incubation period/duration of reaction, temperature of reaction, pH of the system, presence of activators and/or inhibitors.

Some textiles are composed of cellulosic/lignocellulosic materials and thus are good candidates for cellulase enzyme treatments. Cellulases have been used in many applications of the cellulosic fibres to obtain stone washing effect of dyed denims, altering shades/shading effects of dyed fabrics, surface polishing by reducing hairiness, bio-softening, improved water absorption and also for removal of impurities and sizing materials (Koo et al., 1994; Achwal, 1995; Ajgaonkar, 1995; Ellis, 1995; Klahorst et al., 1996; Patil and Samanta, Kumar et al., 1997; Shukla et al., 2000; Buschle-Diller et al., 1999; Buschle-Diller et al., 1994). Application of enzyme during conditioning of jute fibre using oil-in-water emulsion leads to notable improvement in spinning process performance substantially (Dutta et al., 2000; Chakrabarti and Sinha, 2001).

Reports on upgradation of look, feel and other textile related properties of jute fibre by enzyme treatments are also available in literature. Jute is a multiconstituent bast

fibre containing cellulose, hemicellulose, lignin, pectins and some other minor constituents; treatment with a suitable combination of enzymes may prove more effective than treatment with a single enzyme system for property retention/modification of jute fibres/fabrics with marginal but meaningful advantageous features (Samanta et al., 2008a,b; Ghosh and Dutta, 1980; Ghosh and Dutta, 1983; Dutta et al., 2000; Kundu et al., 1962; Sur et al., 1983; Kundu et al., 1991; Kundu et al., 1993; Dutta and Ghosh, 1994; Kundu et al., 1996; Majumdar et al., 1996; Chattopadhyay et al., 1997a,b; Mohiuddin, 1998; Chattopadhyay et al., 2000a,b; Chattopadhyay et al., 2001; Majumdar et al., 1987; Chakrabarti et al., 1991; Chakrabarti et al., 1995).

2.3.8 Treatment with silicone (antifriction agent)

Silicones are poly-organo siloxanes having a backbone of alternating silicone and oxygen atoms (-Si-O-). Silicones play an important role in textile chemical finishing with special reference to cotton textiles or blends of cotton and they offer unique properties such as soft feel, bounce, resilience, antifriction character and lustre to the relevant fabric (Ellis, 1995; Rajadhyaksha and Keskar, 2002; Sinha and Gupta, 1986; Basu and Chattopadhyay, 1996). It would be interesting to study effect of application of selected silicones on jute and related ligno-cellulosic textiles. A small amount of controlled application of antifriction agent (silicone emulsion) applied with oil in water emulsion on jute fibres makes its spinnability improved, provided not applied in excess (which deteriorates its spinnability). Effects of such treatment of Jute Fibres with enzyme and Silicones on changes of fibre properties and its processibility (spinning) are reported (Samanta et al., 2008a,b) in recent past.

2.3.9 Treatment of jute fibres with jute batching oil or its substitute as processing aids

A commercial grade hydrocarbon-based mineral oil commonly referred to as jute batching oil (JBO) (boiling point, 285°C, flash point, 130°C, Red-wood viscosity, 63 s and density, 0.825 g/cm³), was used for preparation of oil-in-water emulsion; here, a poly-hydroxy-ethylene-based non-ionic surfactant is generally used as the emulsifier. The weight proportions of oil, water and emulsifier in the final emulsion and its application percentage may vary according to season and moisture content of raw jute taken. to maintain an average of 1.5% oil content and nearly 35%–37% moisture respectively on weight of jute fibres. Effects of pre-spinning additive treatment on jute fibres using different bio friendly lubricant cum conditioning agents as compared to the effect of such treatment with 1.5%–2% conventional jute batching oil (JBO) treatment has been reported in recent past showing that Castor oil and silicone combination gives an overall better balance for spinning processibility instead of JBO or other alternate lubricant and conditioning agents (Samanta et al., 2008a,b).

2.4 Mechanical processing of jute: spinning of jute yarns

The ultimate cells of jute fibre are built up to form fibre bundles that lie just below the cortex or bark, and are arranged in a circle around the woody core of the jute plant; they run from the root to the tip. The fibre bundles are interconnected by fibrous branches of a few ultimates thick that migrate from one bundle to another and from a complex network of jute fibres. There are very short lengths between branches, and when it is processed with pins as in carding and gilling, the fibre bundles are split lengthwise into to produce finer and shortened spinner's fibres (Cook, 1993). This reduces the fibre length to a few centimetres and the number of ultimates per single filament (Smith, 1944; Samanta et al., 2008a,b) from five to about 8.

The details of the spinning process depends much upon the type of (final) end-use product to be made (Stout, 1985; Pal, 1952; Ranjan) but, there are some common features too; in each case, jute is required to be (a) softened and lubricated with oil in water emulsion so that fibres may be processed without excessive breakage and waste and also (b) the meshy nature of the reeds is required to be broken for parallelization of the separated fibre strands as far as possible. The fibres are also commonly drawn evenly into a sliver or loose untwisted parallelized band. The sliver so formed, are then finally drawn out and twisted in a spinning unit to form yarns of a specified linear density. Following flow chart (Chart 1) shows different steps involved for making of jute yarns.

2.4.1 Spinning process for making jute yarns

Raw jute (untreated Jute Strand) fibres treated with suitable additives like oil (JBO) in water emulsion followed by piling and conditioning are subjected to carding at Breaker card followed by Finisher carding with or without intercarding (used only for very coarser type of raw jute for coarser jute yarn production) and then after three to four passage of drawing, the finisher drawing sliver is subjected to Jute spinning process in slip draft or apron draft jute spinning machine for jute yarn making of desired count. For conditioning an emulsion of jute batching oil containing 6%–10% oil is sprayed using a hand sprayer on each fibre sample After 24 h batching/piling/conditioning, the raw jute fibres strands (jute reed) after eliminating/cutting some portion of hard roots, are successively processed through two or three successive carding machines (a Breaker card followed by a Finisher card. sometimes intercard in between these two cards are also used for coarser variety of jute) and then passed through screw gill type three stages of jute drawing machines to obtain a uniform sliver of parallelized fibres of desired weight per unit length (about 2475 tex) at finisher drawing stage. The sliver from the third or finisher drawing are finally spun into yarn using a Mackie's standard apron draft or slip draft jute spinning machine imparting an optimum level of twist (215 twist per metre) using a flyer speed of about 3800 rpm, for making jute yarn of about 6–10 lbs/spyndles (linear density of jute yarn is expressed in terms of grist i.e. lbs/spyndles as a unit, which is the weight of 14,400 yds of jute yarn in lbs, where 1 lbs/spy = 35.56 tex). Coarser variety of Jute weft yarn can be made similarly with required alteration of process parameters and less precision control for 16 lbs/spyndle to 32 lbs/spyndle jute count (grist).

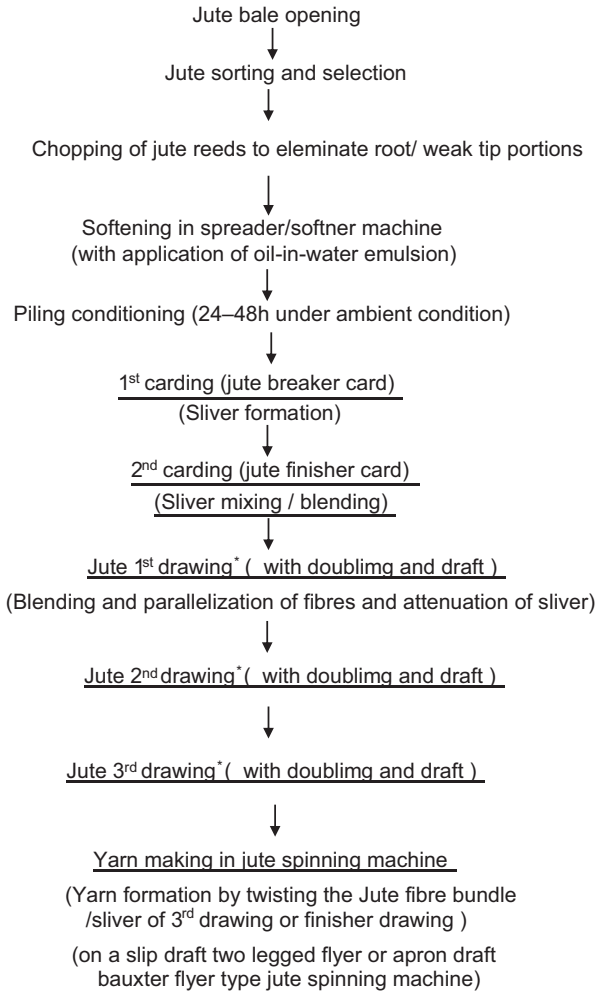

Chart 1 Flow chart for yarn making from jute fibres.

2.4.2 Processibility of chemically treated/modified jute fibres

In one of the early studies, it was observed (Das, 1958) that mild alkali treatment on jute fibre improves the property of yarns made from the said treated fibre. Later on, some reference¹⁹³ to works relating to effects on yarn property parameters made from alkali treated jute fibre were also reported. A few Reports on improvement of the spinning quality of jute and allied fibres by using different oxidative agents (Basu and Chattopadhyay, 1996) and dilute alkalis (Das, 1958) are available in the literature. It was observed that work of rupture of jute yarn made from jute fibre treated with a combination of H_2O_2 and $K_2S_2O_8$ at room temperature was remarkably higher than that of the yarn made from raw jute fibre (Basu and Chattopadhyay, 1996).

Some reports on changes/improvements in some property parameters of yarns made from chemically treated/modified and enzyme treated jute fibres are available (Das, 1958; Ghosh and Dutta, 1980; Ghosh and Dutta, 1983; Dutta et al., 2000; Sur et al., 1983; Sinha et al., 1977; Rahman et al., 1996a,b; Ali et al., 2001; Samanta et al., 2004) in literature.

Effect of Treatment of jute fibres with mixed enzyme and amino silicone (Samanta et al., 2008a,b) on fibre properties and spinning processibility and similarly effects of changes in fibre structure and properties as well as spinning processibility for treatment of Jute fibres with acrylamide and glycol (PEG) (Samanta et al., 2007; Basu et al., 2008) have been detailed in literature in recent past showing some advantageous features for yarn making.

2.5 Jute weaving

Jute weaving sheds consists Jute warp yarn winding (spool), Jute weft yarn winding (cop), Jute pre-beaming and beaming without or with sizing, Jute Weaving using ordinary jute looms (sacking looms and hessian looms) and also in shuttleless looms followed by inspection and damping and calendaring and rolling, additionally Cutting and Sewing for manufacture of Jute Sacks followed by bale pressing. Weaving in general is a process of interlacement of two series of threads called “wrap” and “weft” yarns to produce the fabric of desired quality. The definition (Textile, 1995) with weave pattern for major two types of fabrics of jute, i.e. for hessian and sacking, which are woven in separate types of looms is given below.

Hessian: A plain cloth (one up one down) made from single yarns of Jute approximately having the same linear density of warp and weft yarns usually made from jute.

Sacking: A general name applied to coarser types of Jute fabrics used chiefly for making of Jute bags or Jute sacks. Jute sacks made of jute-based warp and weft yarns are nowadays partially replaced by hemp, flax or polyolefin bags, where the number of threads per centimetre may vary from 2 to over 12.

The Jute Cloth and Bags (Sacks) specifications generally used are as follows (Table 2.4).

2.5.1 Jute weaving techniques

Amongst the different technologies of manufacturing fabric, weaving can be considered to be the most ancient and acceptable method of manufacturing a piece of cloth. This involves at least two sets of yarns, the longitudinal warp yarns and the transverse filling/weft yarns which will interlace with each other, generally perpendicularly, to form a cloth. This technology of weaving is generally accomplished in a weaving machine, popularly known as a Loom, a device that holds the warp threads in place while filling threads are woven through them. The warp yarns run lengthwise, parallel to the selvedge, from one end to the other end of the cloth, while the weft/filling yarns run

Table 2.4 Jute cloth and bag specifications. (a) Jute Cloth (Hessian, Sacking and other Jute Clothes) Specifications.

Product	Warp/Dm X weft/Dm (Porter X shot)	Width	Wt./Sq.m (Wt./yd)
Hessian cloth	47 × 47 (11 × 12)	1.02 m. (40")	305 g/m ² (5–16 oz of 40" width)
Sacking cloth (B-Twill)	76 × 31 (6 × 8)	0.675 m. (26.5")	608 g/m ² (14 oz)
Sacking cloth (Govt B-will)	76×28 (6×7)	0.57 m (22.5")	579 g/m ² (10.53 oz/yd)
Sacking cloth (A-Twill)	102 × 35 (8 × 9)	0.675 m. (26.5")	760 g/m ² (16.3 oz/yd)
Sacking cloth (L-Twill)	102 × 31 (8 × 8)	0.675 m. (26.5")	716 g/m ²
Tarpaulin	68 × 39 (8 × 10)	0.762–1.143 m. (30"-45")	380–585 g/m ² (13–20 oz of 45" width)
Canvas	134 × 70 (16 × 18)	0.914–1.143 m. (36"-45")	660 g/m ² (15–16 oz of 36" width)
Carpet backing cloth	55× 47 (14 × 12)	0.914 m (36")	271 g/m ² (8 oz)
Scrim	22 × 15 (5 × 3½)	0.97 m (38")	105 g/m ² (3.29 oz/36")
Soil saver	34 × 27 (8 × 7) {Open area- 50%}	0.122 m (48")	500 g/m ²
Webbing	(i) 68 × 62 (16 × 15)	5 cm (2")	12 lb/144 yds
	(ii) 62 × 31 (2 ply) {15× 8}	9 cm (3.5")	18 lb/144 yds
Bag type	Length X width (Type of bag)	Weight/bag	Warp/dm X weft/dm (Porter X shot)
B-Twill	112 cm × 67.5 cm. (44" × 26.5") Hd.	1020 g (2.25lb)	76 × 31 (6 × 8)
B-Twill	112 cm × 67.5 cm. (44" × 26.5") Hd.	907 g (2lb 2 oz)	76 × 28 (6 × 7)
A-Twill	112 cm × 67.5 cm (44" × 26.5") Hd.	1200 g(2.5lb)	102 × 35 (8×9)
Heavy cees	102 × 71 (40" × 28") Hd.	1021 g (2.25lb)	68 × 35 (8 × 9)
DW flour	142 × 71 (56" × 28") Hd.	1135 g (2.5lb)	68 × 31 (8×8/7×9)
B.Twill (Govt.)	94 × 57 (37"×22.5") Hd.	665 g (1.5lb)	76 × 28 (6 × 7)

from selvedge to selvedge, intersecting the warp yarns at right angles. The way the warp and filling threads interlace with each other is called a Weave which expresses the structural design or construction of the fabric. For the purpose of carrying out the production of a fairly good quality jute cloth with as minimum as fabric faults occurring, it is very essential to maintain a perfect harmony of the different motions of jute loom by properly tuning and setting all the motions. Generally, the important motions of a running loom required to weave a fabric, can be classified as primary motions-without which it won't be possible to weave a cloth, secondary motions to maintain the continuity in production of the cloth and auxiliary motions for the purpose of maintaining the desired quality of a jute cloth. The process of weaving jute clothes i.e. conversion of Jute yarns to Fabric are depicted below.

2.5.2 Conversion of jute yarn to fabric

In general, Jute weaving is an indispensable department for conversion of Jute yam to Fabric in a composite Jute Mill for production of different type of jute fabrics as per end use requirements. In this context, Jute weaving sheds consists of different mechanical processing machinery like, Jute warp yarn winding (spool/cone, etc.), Jute weft yarn winding (cop), Jute Pre-beaming/Warping and Beaming and Sizing for the purpose of making the yarns, mainly warp yarns, weavable and free from objectionable faults, as far as practicable, eventually achieving thereby, a cloth of acceptable quality, produced finally in the Jute Loom. The Jute Weaving Machines, popularly known as Looms can be broadly classified as conventional ordinary jute looms like, Hessian looms, Sacking looms and Broad looms, etc. and modern shuttleless looms which include, rectilinear Rapier found in flexible, rigid and telescopic type, STB projectile (gripper), jute half-circular multiphase rapier looms, (generally known as S4A, One Mack and Two Mack Looms) which are predominantly ruling the commercial jute mills. Once the grey jute fabrics are prepared in the looms, they are transferred to the finishing department of the factory site for the purpose of improving the surface texture and other relevant property parameters of the same. The Finishing Department involves mechanical and/or mechanical with chemical finishing treatment taking place simultaneously followed by the damping, calendaring and rolling, additionally lapping, cutting and sewing operations to inculcate the jute fabric into the finished form of final jute product to suit the end-use requirements. The finished jute products, mainly the jute bags, are then packed in bale pressing machine for consolidation and compactness of the same before they are dispatched for sale.

In the process of weaving, the warp yarns from the weaver's beam are drawn through different parts and accessories (from warp beam to cloth roller) of the loom in such a way so that it can be divided into two sets/layers/groups while passing through the mail-eyes of the camb. By controlling the vertical up and down movements of the camb, the warp yarns are separated into two layers to form the triangular shed paving the way for the weft carrier like shuttle which contains the weft package in the form of cop to run from one end of the loom to the other to insert the weft yarns during picking according to the fabric design. The inserted weft yarn is beaten to the fell of the cloth by the reed of the sley assembly and the weft thread density in a fabric is controlled by the

secondary take-up motion assembly. In jute mills, all of the conventional shuttle looms are electrically motor-driven which may be either individual motor or line shaft and over pick type with the picking assembly lying over the sley line. It requires proper tuning of different motions and proper setting of the different parts for smooth running of the loom, and producing almost fault free fabric of desired specifications.

2.5.2.1 Brief idea about different motions of a weaving machine (shuttle loom)

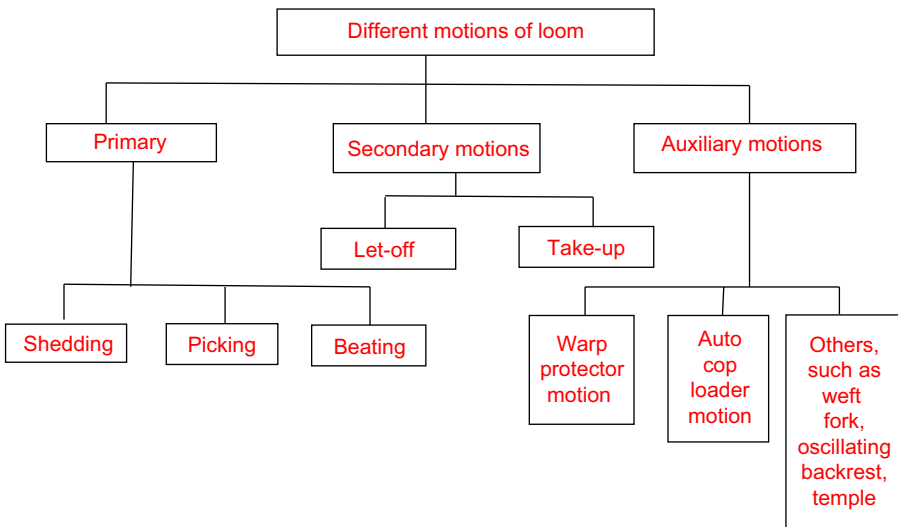

2.5.3 Developments in jute weaving including shuttle less weaving

Though the jute industry for several decades are producing jute fabrics by using conventional ordinary Jute looms as un-comparable to the other textile sectors, which has grown to a large extent. It has been found that there is a gradual reduction in the productivity and high labour complement in jute fabric weaving by conventional ordinary jute looms. Moreover, for improved qualities of jute clothes with much equidistant placing of warp and weft can hardly be expected from these ordinary jute looms. Constant efforts are therefore being made to produce the jute clothes in much better quality with less defects and also at faster rates and thereby, to achieve higher weaving productivity at reduced cost of production by adopting the various methods where the conventional method of weft insertion by shuttle in jute looms appears to be obsolete, but still many industry is using it, considering high investment for procuring new shuttle less looms suitable for jute yarn weaving and moreover good quality jute yarns are required to really gain the higher productivity of shuttle less jute weaving. So special

care in jute yarn manufacture is required for obtaining optimum productivity in jute shuttleless weaving, which now many of the jute mills are using.

These non-conventional methods of weaving, known as shuttleless weaving and such looms are called the shuttle less looms or shuttle less weaving machines. Shuttle less weaving may be gripper-based or rapier-based (flexible and rigid rapier) or multi-phase circular loom type. Water jet or air jet shuttle less looms are not suitable for stiffer and breakable jute yarns. Many jute mills have started using mainly rapier-based jute shuttleless looms to produce Jute Hessian of improved quality and decorative variety of jute or jute-cotton union fabrics in terms of better firmness, equidistant spacing of warp and weft and smooth appearance of fabric surface as compared to those of equivalent quality traditional jute fabrics woven in ordinary jute looms. There are following different types of Shuttle less looms as stated below;

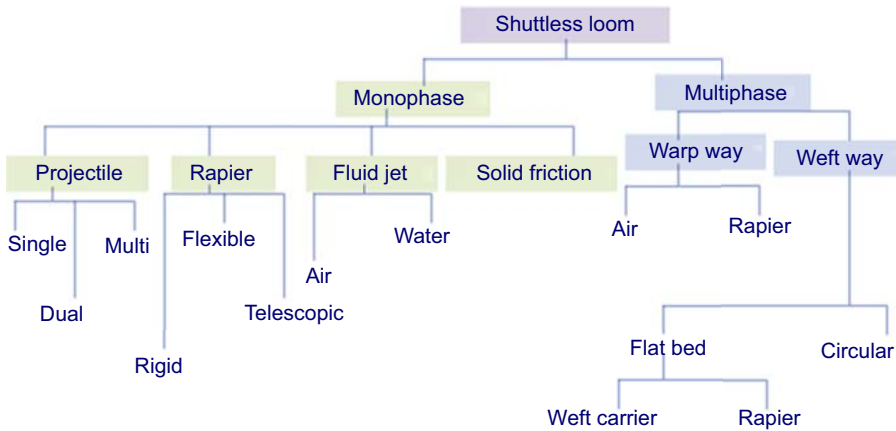

These fabrics reach the market in the form of Jute fabrics or Jute sacking bags of desired specifications after cutting and stitching as well as after required finishing of Jute fabrics and bags.

The jute fabrics produced from weaving pass through various machinery in the finishing department for mechanical and chemical finishing (optional) before dispatch or sale for following objectives:

- i) To remove or mend defects in the grey jute fabric.
- ii) To remove the crease or fold in the fabric.
- iii) To make the fabric surface glossy and smooth
- iv) To improve the appearance and cover of the fabric.
- v) To maintain the desired level of moisture in the finished product.
- vi) To pack the fabric in roll or bale form according to the requirement of the buyer or end use requirements.

Therefore, jute weaving to finishing section has high importance, where ultimate product of the Jute Industry is being generated/produced. So, any fault generated in weaving remains visible/detectable in the marketable product unless it is very minor

and repairable at finishing stage. Thus, main aim of this section of jute industry is to achieve an optimum production of the final jute woven fabrics/products (fabric or bags from jute-based fabric) with minimum defects. The major activities of this weaving department is to run the looms (both Ordinary jute looms and shuttle less Jute looms by proper setting/tuning/maintenance and smooth running of those jute looms, where, the role of the jute loom weavers and weaving sardars/fitters are considered to be very important. Therefore weaving is the most labour intensive department. So, efficiency of this department has a great bearing on conversion cost for fabric. Therefore, even a fractional improvement in weaving productivity as well as quality results enormous benefit. Hence, the weaving process is considered as very important area in the process line of manufacturing Jute fabrics with maximum efficiency and maintaining good/standard quality particularly for hessian, sacking and carpet backing fabrics. However for decorative variety of Jute fabrics, along with jute weaving, proper chemical processing and finishing are also highly important too.

2.6 Chemical processing of jute

Multi-constituent nature and heterogeneity of Jute Fibres (with number of different functional groups present) make it difficult to select the sequences and to standardize the chemical treatment or processing for jute and jute blended or unionized diversified products. It is virtually impossible to limit the location of a chemical treatment of jute specifically on its surface or to one particular constituent due to the possible simultaneous participation of other constituents of jute in any reaction. Degradation of one or other multi-encrustants during any chemical processing/modification make the task more difficult and complex in nature. This is why chemical processing of jute differ in many respect from cotton. Therefore it becomes essential to develop and standardize any type of treatment or chemical processing of jute separately for its multi-constituent nature, however, keeping in view of its end-uses and functional property criteria needed. Hence, the methods and recipe of chemical processings for cotton are not directly applicable to jute.

2.6.1 *Desizing*

Desizing of jute yarns or fabrics are easier than the same processing for cotton textiles, as because, usually Tamarind Kernel Powder (TKP) is used as sizing materials on jute with or without some additives and this TKP is removable by hot water boiling. Hence, if required, for desizing of jute yarns and fabrics, only water boiling is carried out for 30 min followed by normal washing. However, acid steeping is helpful in swelling the starch-based sizes besides simultaneous removal of minerals (cations) to brighten the same. Acid steeping is carried out by immersing the yarns/fabrics in a vessel containing 2-3 gpl HCl at ambient temperature for 30–60 min. Subsequent to acid steeping, the fabric is thoroughly washed before taken for scouring.

2.6.2 Scouring and bleaching

Jute yarns or fabrics are not usually scoured. Even very mild scouring using 4 g/l sodium carbonate and 1 g/l non-ionic detergent treatment at 80°C for 30 min before bleaching causes darkening of colour of jute along with some weight and strength loss. Hence jute materials are directly taken for conventional H₂O₂ bleaching (IJIRA, 1977; Samanta et al., 2007) by 4%–8% (owf) H₂O₂ (50%) at 75–80 °C for 1–2 h with usual additives (2%–2.5% Tri-Sodium phosphate or sodium carbonate as alkali or 0.5%–0.7% Caustic soda (NaOH) as alkali to get required pH in bleach bath, 6%–10% Sodium meta-silicate as H₂O₂ stabilizer, 0.1%–0.5% non-ionic detergent or wetting agent maintaining the pH at 10–11 with MLR 1:5 to 1:6 for jute fabric in jigger and 1:20 for jute yarn in vat. After H₂O₂ bleaching, a hot or cold rinse or dilute acid steeping (1% aqueous HCl at room temperature for 10–15min) is also required. Conventional H₂O₂ bleaching is an eco-safe process (Samanta et al., 2007; Pan et al., 2003; Samanta and Ray, 2000), however, use of sodium-meta silicate stabilizer increases the BOD and COD load of the effluent and hence it is better if it can be avoided by any other alternative. For eco-friendly bleaching process of jute yarns/fabrics it has been suggested in literature (Pan et al., 2003; Samanta and Ray, 2000) to replace 6%–8% sodium silicate or sodium meta-silicate stabilizer by 10gpl Stabilizer-AWNI (an eco-safe organo-phosphate stabilizer manufactured by Sandoz/Clariant) or any other organic stabilizer like sodium salt of diethylene triamine penta acetic acid etc, for H₂O₂ bleaching.

Jute being sensitive to NaOH treatment, simple and much milder scouring of jute yarns and fabrics are done by either using 1-2 gpl detergent or good emulsifying agent at boiling temperature or with a solution of 2 gpl soda ash and 1 gpl non-ionic detergent at 70°C or at boiling conditions for 15–30 min (Gulrajani and Gupta, 1992; BTRA, 1997). Addition of 2-3 gpl emulsified organic solvent-based scouring aid is always advantageous in obtaining better/uniform scouring (Samanta and Ray, 2000).

In past, an emulsified solvent scouring (IJIRA, 1977) method has also been developed for jute to completely remove mineral oil or any other jute batching oil together with other adhering/extraneous impurities, since batching oil of jute, if present in jute, has a delustering effect and also contributes to additional yellowing on exposure to light. Besides uniform scouring and complete removal of mineral oil-based jute batching oil, another important advantage of this process is higher retention of strength of the fabric. But partly due to costliness of this process and partly due to mill personnel's ignorance about handling of the solvent, its commercial exploitation is still limited.

Moreover, for jute blended or unionized fabrics (e.g. jute/cotton union fabric or jute/viscose blended fabrics etc.), the chemical pre-treatment necessary for cotton part cannot be applied on blended/unionized fabric, keeping in mind to protect jute. Also recipe for all-jute fabric is not directly applicable for jute blended or unionized fabrics. Hence, separate process recipes have been developed for such fabrics. Scouring and bleaching of jute/viscose (60:40) blended fabric has been suggested (Gulrajani and Gupta, 1992) by treatment with 2% (owf) Na₂ CO₃ and 1gpl non-ionic detergent heating at 80°C for 30 min followed by usual H₂O₂ bleaching using 4% (owf) H₂O₂ (50%) at 80°C for 30–60 min, controlling the pH of bleach bath between 8 and 8.5 to

protect viscose part in blend. Scouring and bleaching of jute/cotton (75:25) unionized fabric has been suggested (Ghosh and Samanta, 1996) by treatment with 4gpl Na_2CO_3 and 1 gpl nonionic detergent (heating at 100°C) for 60 min, followed by usual H_2O_2 bleaching using 4% (owf) H_2O_2 (50%) with usual additives at $90\text{--}95^\circ\text{C}$ for 1 h, maintaining the pH at 10–11.

Previous report (Sengupta and Radhakrishnan, 1972a,b) for softening and bleaching of jute fabric entails to do bleaching first and then to do a dilute (5%) NaOH pre-treatment. This sequence of process has the drawback of browning/darkening the surface colour of jute fibre by post-NaOH treatment, over the whiteness achieved on bleaching. Hence, sequential chemical texturing and bleaching (STB process) referred above (Gulrajani and Gupta, 1992; BTRA, 1997) is found to give better balanced properties of bleached jute and jute blended/unionized fabrics. By this process, the fabric become well shrunk and compact with greater resiliency (along with high extensibility) and softness.

room temperature bleaching of jute, cotton and jute-cotton union fabric has been studied and standardized (Pan et al., 2003) achieving whiteness level up to 68–70 unit, using additional 0.75% $\text{K}_2\text{S}_2\text{O}_8$ and 2.5% NaOH (replacing trisodium phosphate) as compared to conventional 6% H_2O_2 (50%) bleaching for jute fabric keeping same recipe of other additives as usual, deeping the fabric for 4–6 h at room temperature. This method of bleaching of jute or jute-cotton union fabrics is cost effective and is easily adaptable in both large scale and small scale decentralized jute sector. The most widely used recipe conventional hydrogen peroxide bleaching of jute and recently developed room temperature hydrogen peroxide and Potassium Per-oxo di-sulphate combination bleaching of jute are as follows (Table 2.5).

The main drawback of jute or bleached jute yarns and fabrics are its excessive hairy surface appearance, high fibre shedding and its accelerated photo-yellowing under uv-light or sunlight, which however is estimated to be higher for bleached jute materials than that of raw jute yarns and fabrics. Hence, Chemical de-hairing of jute yarns and fabrics become a prime requirement for production of value added products from jute.

2.6.3 Chemical dehairing and photo-stabilization of jute yarns and fabrics

Partial Photo stabilized bleaching of jute fabric includes mild acidic oxidation using 2% (owf) oxalic acid pre-treatment followed by treatment with sodium or calcium hypochlorite (having 5-6 gpl available chlorine) at MLR 1:3 in jigger before final wash with 2 gpl HCl followed by final H_2O_2 bleaching, as per whiteness required, known huetex bleaching (IJIRA, 1977). But this process is difficult to control and results high strength loss of jute fabric.

Later a modified process of chemical dehairing and light fast bleaching process (CDB-process) for jute fabrics (Bagchi and Som, 1998) was made available for partial tackling both the problems of photo yellowing as well as removing hairiness of jute fabric along with its bleaching. This newer process can be viewed as a modification of old Huetex stabilized bleaching process for jute. In this newer chemical dehairing

Table 2.5 — Recipe and treatment condition for oxidative bleaching of jute fibre.

Chemical and treatment condition		Oxidative bleaching with H ₂ O ₂	Oxidative bleaching with the combination of H ₂ O ₂ and K ₂ S ₂ O ₈
Hydrogen peroxide	—	3%	3%
Potassium per-oxo-disulphate	—	—	0.75%
Sodium meta-silicate	—	8%	8%
Sodium hydroxide	—	0.7%	2.5%
EDTA as sequestering agent	—	0.05%	0.05%
Non-ionic wetting agent (Ultravan JU)	—	0.5%	0.5%
Fibre to liquour ratio	—	1: 15	1:15
PH	—	11	11
Time of treatment	—	2 h	2 h
Temperature	—	85°C	30°C
Process	—	Treatment was carried out in exhaust bath	Treatment was carried out by pad (100% wet pick-up)- batch process

cum light fast bleaching process, drastic strength loss (as in Huetex process) of jute fabric can be avoided. This process consist broadly the following steps:

Hypochlorite oxidation (at pH 6.0–6.5) → Extraction of surface lignin → Usual bleaching with H₂O₂

The advantages of these newer process are:

- (i) Lightfastness rating to sunlight exposure is around grade-III (instead of lightfastness grade-I, as obtained for conventional bleached jute fabric).
- (ii) Higher fastness to light is obtained for jute/cotton union fabrics.
- (iii) Smooth dehaired surface in appearance.
- (iv) Strength loss and weight loss are within tolerable limit.

However, this process has gained less commercial success for the higher cost involvement in this multistage sequential treatments, besides the difficulty of controlling the p^H of the first stage of treatment, and hence the non-reproducibility of the results.

There are some reports on earlier developed methods of improving photostability of jute by different research groups those are based on either reduction treatment with sodium hydrosulphite/sodium borohydride, commercial UV-absorbers etc (Banerjee et al., 1985; Achwal and Sinkar, 1993), nickel chelates and ligands like diethyl-dithio-carbamate, dithio-oxamide, azo-benzo-thiazole etc (Abdullah and Miles, 1985) and hydroxy benzophenone (Farouqui and Hossain, 1990a,b,c,d). All of them had limited success due to their non-durability, lesser effectiveness in photo-stabilization

and also for cost ineffectiveness. Standardization of extraction and dyeing for application of natural dyes on jute has been reported in nut shell including improvement of colour fastness etc (Samanta et al., 2004).

Recently a breakthrough work (Samanta et al., 2009) has been reported for achieving photostability of bleached jute fabric by applying a very low doses of a simple UV-absorber (benztriazole) following a special reaction condition to make it substantive to jute (mechanism of reactions have also been postulated and validated in the referred work) for obtaining comparatively better photo-stabilization of both bleached or dyed jute fabrics than the earlier processes stated above. It can be applied either in bleach bath or by usual pad-dry-cure technique in finishing bath subsequent to bleaching or dyeing, where both the techniques of application of benztriazole on jute renders good photo-stabilizing effect on bleached jute fabrics and dyed jute fabrics.

2.6.4 Dyeing of jute yarns and fabrics

Jute can be dyed with many classes of dyes, viz.- direct, basic, acid, pre-metalized, vat, azoic (naphthol), reactive and sulphur dye as well as with pigment colours and natural dyes. However, it is difficult to obtain good light fast dyed jute products for its inherent photo-yellowing propensity under exposure to UV-light/sunlight. Jute being naturally varying in colour, poses difficulty in colour matching particularly for light shades. Moreover, most of the direct dyes and acid dyes have poor wash fastness and rubbing fastness on jute. Basic dyes show overall poor lightfastness, poorer than any other classes of dyes. Many azo-based direct dyes, acid dyes and basic dyes have been banned (Stout, 1985; Bandyopadhyay, 1951) due to their possible release of listed carcinogen amines, during use or washing etc and hence choices of such dyes and their colours have been reduced. However, all direct dyes, basic dyes and acid dyes are not banned and all do not contain objectionable toxic amines. Vat dyes though have all round good colour fastnesses (except lightfastness as because, even for vat dyes lightfastness on dyed jute appears to be poorer due to inherent photo-yellowing problem of jute itself), but those are very costly to apply on jute. Sulphur dyes are available in limited colours only and thus have shade limitation. Some pre-metalized dyes are not eco-friendly for presence of objectionable heavy metals. Only, reactive dyes have overall good colour fast to all agencies except colour fastness to bleaching liquor and is not that costly, and hence is considered to be best alternative for manufacturing good quality dyed jute products. However, the dyeing cycle for reactive dyeing is longer and dyeing production therefore become higher. Dyed jute yarns and fabrics are used in producing different dyed decorative items and as base fabric for subsequent printing and finishing. Poor colour fastness and Eco-ban towards certain direct, acid, basic dyes and azoic colour (so far, total 112 azo-dyes are banned in India) (Gazette) excludes them for use them in dyeing of exportable jute products. So, presently in dyeing of jute products, only eco-safe dyes are being used in Indian Jute Industry.

Among all the synthetic dyestuff, almost all reactive dyes, vat dyes as well as most of the natural dyes (except few) are the best alternatives available as eco-safe dyes applicable for jute or cotton textiles. For reducing pollution in the dye bath effluent (waste dye liquor) for dyeing of textiles, certain dyeing auxiliaries/additives are also

to be avoided. Hence conventional dyeing processes of jute have started to be reinvestigated by many researchers for development of eco-friendly processes of bleaching and dyeing of jute materials. Sometimes, the eco-friendliness in dyeing is unnecessarily over stressed, it is to be kept in mind that almost all reactive dyes and vat dyes are eco friendly. It is true that all the natural dyes may or may not be toxicity-free or eco-friendly, hence, they need testing of toxicity or eco-friendliness by any authentic source or report.

Dyeing of jute has been initially reported scientifically in literature by Patro (Patro, 1971) and later the further development and standardization of dyeing process variables with different classes of synthetic dyes have been reported by others (Patro, 1971; Farouqui and Hossain, 1990a,b,c,d; Ganguly and Chanda, 1994; Chattapadhyay et al., 2002; Sinha and Raymallick, 2002; Laga et al., 1997; Lokhande and Dorugade, 1998). In industry, jute fabrics are being dyed with either of the direct dyes, acid dyes and basic dyes (acid dyes and direct dyes are anionic and basic dyes are cationic in nature) either at yarn stage (in vat or winch type yarn dyeing machines) or at fabric stage in jigger, followed by necessary after-treatments with appropriate dye fixing agents of either cationic (for both acid dyes and direct dyes) or anionic (for basic dyes) nature for improving wash fastnesses of dyed jute products mainly for local markets. However, now direct dyes offering higher wash and lightfastness have been developed by many dye manufacturers that are also being used for export marketable dyed jute products to achieve required fastness level. However, in cases of stringent wash, light and rub-fastness requirement for either domestic or exportable dyed jute products, use of Reactive dyes, Vat dyes or Sulphur dyes are recommended.

2.6.4.1 Application of direct dyes on jute

(a) Principles

The majority of the direct dyes are sulphonated azo components, which ionize in an aqueous medium, the coloured component or chromophore constitutes the anion. Direct Dyes are planar and fully water-soluble. Direct dyes are comparatively low cost dyes and easy to apply. Direct dyes are sensitive to metal ions and therefore soft water is required. Direct dyes are either acid/salt/alkali sensitive and accordingly they are classified as I, II or III (or A, B or C). Hence, in compound shade, for use of mixture of dyes, same type/class of dyes are only to be used for level shade. However most of the direct dyes are salt sensitive. Direct dyes are represented chemically as DSO_3Na ; when D is the dye-chromophore and they dissociate in water as follows:

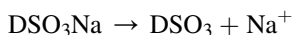

Direct dyes have usually poor light and wash fastness, except few dyes developed specially. Hence, after – treatment (post-dyeing-treatment) of direct dyed textiles with Cationic dye fixing agent, $CuSO_4$, Sodium di-chromate ($Na_2Cr_2O_7$), Formaldehyde and Post-treatment with methylol resins or by diazotization etc. is the route to improve the colour fastness to wash for direct dyes.

Generally, all these after-treatments improve colour fastness to washing for direct dyes. However, use of Cu-salt, Cr-Salt and formaldehyde etc. are not eco-friendly.

Many of the direct dyes, containing listed banned amines; are banned in India and in many countries. Before use of any direct dye, that list of banned dyes must be consulted to exclude them. The following dye bath recipe and method may be followed for direct dyeing of jute materials::

(b) Dyeing Recipe (Direct Dyeing):

Direct Dyes → X% (as per shade required), Soda Ash (Na_2CO_3) → 0.5%–2% (owf), Common Salt (NaCl) → 5%–10% (for light shade) and 10%–30% (for dark shade), MLR: 1:20 or 1:25 in vat for yarn and 1:5 to 1:6 in jigger for fabric. For dyeing Pale shades, Lissapol-D or Dispersol – VL or TRO may be added to obtain level shade

(c) Dyeing Method (Direct Dyeing):

After appropriate preparatory chemical pre-treatment of jute yarns or fabrics, dye solution and dye bath has to be made ready by adding solubilized dye solution to the dyeing media (water taken in dye bath) and raising the temperature of dyeing liquor nearly about 60°C. Then desized and scoured or scoured and bleached jute yarns or fabrics (prewetted with water and 0.5% wetting agent) are to be immersed (for yarn) in the dye bath prepared in vat or hank dyeing machine or to be rotated (for fabric) in jigger for 2-3 turns/ends for uniform initial absorption of colour at 60°C. After giving one or two ends of running the fabric in dye bath having half dye, the rest dye is to be added for level shade. Common salt as exhausting agent is to be preferably added in two/three instalments, where the first addition is to be done after first 10–15 min from commencement of dyeing. After addition of first instalment of salt, gradually the temperature of dye bath is to be raised to boil (atleast 85–90°C) and the quantity of salt in the dye bath is to be increased by further addition of it after each 15–20 min interval; All the salt addition are to be done within next 30–45 min. Then dyeing is to be continued at boil (at 85–90°C) for another 45–60 min depending on the shade depth required. For pale/light shade – Dye bath temp. may be kept at 60–70°C. After the dyeing is over, the dyed material is to be allowed to cool, before draining out the waste dye liquor followed by normal water washing and or rinsing with hot water to remove unfixed dyes. Final cold water wash and drying is also essential. A light 1 gpl detergent wash may also be given, if required.

Continuous rotation or stirring of hank of jute yarns in the dyeing vat or rotation of fabric from one end to other end in jigger is essential for level shade. For loose jute fibres (reeds or slivers), to get uniform dyeing, it is better to use perforated cage to keep the loose fibres loosely stacked there in the cage and dyeing liquor may be circulated to get good results.

(d) After-treatments (After direct dyeing):

Direct Dyed Material is to be treated in a bath containing Cationic Dye Fixing Agent – 2% (owf.) (say, Sandofix –HCF, HICOFIX – GL, FIXANOL – C etc.), Glacial Acetic Acid – 1–2 mL/L at 70°C, for 30 min, using M.L.R – 1:10 in vat (for yarn) and 1:5 in jigger (for fabric). After the treatment is completed, light soaping

with 2gpl soap at 60°C followed by normal water wash and rinsing before final drying are to be done.

After treatment for direct dyed jute or cotton goods can also be accomplished by many other cationic chemicals like copper sulphate and formaldehyde (both not eco-friendly), cationic resins, quaternary amines or any complex forming agent (enabling to form complexes with direct dyes), however, most of these chemicals changes the tone of the colour/shade developed on the dyed fabrics. However this is mentionworthy that the process of dyeing jute with selective direct dyes and their fastness character have been reported in literature by Farouqui and Hossain (1990a,b,c,d).

2.6.4.2 Application of acid dyes on jute

(a) Principles

The term 'acid dye' denotes a large group of anionic dyes with relatively low molecular weights that carry from one to three sulphonic acid groups. Like direct dyes, they may be chemically represented as DSO_3Na and when dissociates in water, they produce coloured anion (DSO_3^-) and colourless cation (Na^+). Chemically acid dyes belong to various subclass – such as monoazo, nitro, nitroso, diazo, xanthene, azine, anthraquinone, quinoline etc.

SDC (Society of dyers and colourists, UK) have classified acid dyes into four groups:

- (i) Strongly acidic
- (ii) Moderately acidic
- (iii) Weakly acidic and
- (iv) Very weakly acidic or neutral (addition of glauber salt is essential).

However, practically acid dyes are classified on the basis of application method and wet-fastness properties into three categories as follows:

- (i) Levelling acid dyes or equalizing acid (low molecular weight and strongly acidic)
- (ii) Milling acid dyes (weakly acidic and higher molecular weight than levelling acid dyes).
- (iii) Super milling acid dyes (corporatively high molecular weight and neutral acid dyes).

Moreover, there are some dyes considered to be included in acid dyes, which are the reaction product of Cr, Co, Ni etc and selected anionic dye chromophore capable of coordinating to those metals, called 1:1 or 1:2 metal complex dyes.

Acid dyes are also anionic, but non-planar and smaller in size, while direct dyes are planar and large in size. Acid dyes are highly substantive to silk, wool, and polyamide etc. Acid dyes have no substantivity to celluloses. But for ligno-cellulosic fibres like jute, acid dyes have moderate to good substantivity, probably due to presence of non-planar and amorphous lignin structure. Jute takes acid dyes probably due to presence of lignin in jute. The mechanism is still unknown. However, it is reported that partial removal of lignin affects the acid dye uptake adversely (Ganguly and Chanda, 1994). Also for low doses of removal of hemicelluloses, acid dye uptake reduces, but

removal of hemicelluloses nearly 70% and above, the acid dye uptake of jute improves (Ganguly and Chanda, 1994).

Most of the acid dyes show poor wash fastness on jute, even by mild rinsing in cold water; though some acid dyes are moderately fast. But, metal complex dyes have excellent wash and lightfastness and therefore is most suitable for jute. Some metal complex dyes retard photofading of jute under sunlight, by UV quenching action.

Acid dyes are water or weakly acid soluble. Acid dyeing of wool, silk and polyamide require retarder for assuring uniform dyeing. Acid dyes are very much pH sensitive and have good degree of penetration. In alkaline or neutral pH, acid dyes are absorbed as direct dye because both are similar in nature. Hence, acid dyes to make it absorbed as acid dyes are usually applied in acidic medium.

(b) Dyeing Recipe (Acid dyeing):

The following dye bath recipe and method may be followed for acid dyeing of jute materials:

Acid Dyes → X% (as per shade required), Dyeing auxiliaries and additives: 1%–2% Acetic acid (30%) or Formic acid (40%) or 2%–5% Alum, 5%–10% Common salt, 2%–5% Glauber Salt, MLR: 1:15 or 1:20 in vat for yarn and 1:5 to 1:6 in jigger for fabric. For dyeing pale shades, to control the pH, acetate or formate buffer is used to keep pH between 4 and 4.5 by adding 4% Ammonium or Sodium acetate or formate and 2% Acetic acid (30%) or Formic acid (40%), besides addition of Lissapol-D or Dispersol – VL or TRO to obtain level shade.

(c) Dyeing Method (Acid dyeing):

The dye bath is to be set initially with hot water (Zero hard water should be used or 0.25%–5% sequestering agent (EDTA) should be used in bath to arrest residual metallic ions present in water or coming out from jute) at 50°C without dye, but with addition of 4% ammonium or sodium acetate or formate with 2% acetic acid (30%) or formic acid (40%) (to maintain the acidic pH) as buffering agent, having MLR of the bath 1:15–1:20 in vat for yarn or 1:5 or 1:6 in jigger for fabric. After appropriate preparatory chemical pre-treatment of the textile materials (yarn or fabric), these are to be pre-wetted with wetting agent solution and should be run in the said bath without dye for 10–15 min at 50°C. After this, the prepared dye paste (with small amount of acetic acid) of the acid dyes should be added to the bath at 50°C. Then the material is to be run for few minutes for initial dye absorption by rotating the yarn hank or rotating the fabric in jigger for 2–4 ends. Then the temperature of the dye bath is to be raised to boil (100°C) within 20–30 min continuing the dyeing by stirring or rotating the yarn hank or rotating the fabric in jigger from one end to other end and reverse. Almost after half the dyeing time is over, common salt (5%–10% owf) or glauber salt/(2%–5% owf) and if required additional 2%–5% formic acid (40%) or acetic acid (30%) or alum are to be added to maintain the pH of dye bath. Dyeing is to be continued and the material is to be stirred or rotated in the boiling dye bath for another 30–45 min. Total dyeing time will be about 60–90 min depending on shade depth. After the dyeing is over, the dyed material after cold water wash and

hot water wash is to be finally washed with 1 gpl non-ionic detergent/soap solution for 10–15 min before rinsing with water and drying.

(d) After treatment (After acid dyeing):

Acid dyes applied on jute show poor to moderate wash fastness and hence proper after-treatment to improve the wash fastness of acid dyed jute products is essential. Like after-treatment after the direct dyeing, the similar process of after-treatment is to be followed for acid dyed jute to improve its wash fastness as follows:

After-treatment of acid dyed jute yarns or fabrics is to be carried out using 1%–3% Cationic Dye fixing Agent (Eroal – NW or Mesitol – NHS etc) in acid medium. Also after-treatment of acid dyed jute products can also be carried out with formic acid or tannic acid, but they change the shade to some extent.

2.6.4.3 Application of basic dyes on jute

(a) Principles

Basic dyes are cationic in nature. Basic dyes are low cost and offers brilliant shades having high colour value and are considered best among the brightest dyes available, but it shows poor to medium lightfastness. Chemically basic dyes have diphenyl (tri-phenyl methone, Azine, Triazin, Xanthene, Oxazine type of chromophore with a cationic charge residing in either main chromophore structure or the cationic charge residing at a distance (pendant to the chromophore) from the main conjugated chromophore structure. The later being called as modified basic dyes and are more light fast than the former type (ordinary basic dyes).

Basic dyes have good solubility in water, show excellent exhaustion, offer unlimited range of shades but render poor lightfastness. Many basic dyes are destroyed by chlorine, so, chlorine free water must be used in dyeing with basic dyes. For high substantivity to acrylic or wool fibres, it needs suitable retarder for uniform dyeing. For jute application of retarder is not essential but is optional. Presence of metal ion, changes shade of the basic dyes, so EDTA should be used to chelate the metal present in water or in jute itself.

A study on the optimum dyeing conditions for dyeing jute with basic dyes has been reported in literature by Farouqui and Hossain (1990a,b,c,d).

(b) Dyeing Recipe (Basic dyeing):

The following dye bath recipe and method may be followed for basic dyeing of jute materials:

Basic Dye/Modified Basic Dye – X % (depending on shade depth required), Wetting agent – 0.5%, EDTA (Sequesterent) – 0.25%–5% (depending on the hardness of water), Acetic acid (30%) – 5% and/or Alum – 5% (for jute) to maintain pH – 4–4.5 (if required it can be adjusted by use of acetic acid and sodium acetate buffer), Glauber Salt/Common salt – 4%–6% (for jute), Retarder (optional) – 1.5%–3%, M.L.R. – 1:15–1:20 in vat for yarns and 1:5–1:6 in jigger for fabrics; Dyeing temperature – Initial at 50°C and final at 100°C and Dyeing time – 60–90 min for jute.

(c) Dyeing Method (Basic dyeing):

The dye bath is to be set initially with hot water (Zero hard water should be used or 0.25%–5% sequestering agent (EDTA) should be used in bath to arrest residual metallic ions present in water or coming out from jute) at 50°C without dye, but with addition of 2% acetic acid (30%) or formic acid (40%) (to maintain the acidic pH) as buffering agent, having MLR of the bath 1:15–1:20 in vat for yarn or 1:5 or 1:6 in jigger for fabric. After appropriate preparatory chemical pre-treatment of the jute yarns or fabrics, these are to be pre-wetted with 0.5% wetting agent solution and should be run in the said bath without dye for 5 min at 50°C. After this, the prepared dye paste (with 2% acetic acid and/or alum) of the basic dyes should be added and stirred well to the above said chemical bath at 50°C. Then the material is to be entered and run in the dye bath for few minutes for initial dye absorption by rotating the yarn hank or rotating the fabric in jigger for 2-4 ends. Then the temperature of dye-bath is to be raised up to 90–100°C with continuing dyeing with stirring or rotating the materials in vat (for yarn) or jigger (for fabric). Total dyeing time will be around 60–90 min, hence the material is to be run in vat or in jigger for 60–90 min with two stage addition of Gamber Salt and retarder (optional), if any. After obtaining the correct shade and completion of dyeing, the material is to be cooled to nearly 50–60°C. After the dyeing is over, the dyed material after cold water wash and hot water wash is to be finally washed with 1 gpl nonionic detergent/soap solution for 10–15 min before rinsing with water and drying.

(d) After-Treatments (After Basic dyeing):

Basic dyes applied on jute show poor to moderate wash fastness and also poor lightfastness and hence proper after-treatment to improve the wash and lightfastness of basic dyed jute products is essential. Like after-treatment after the direct dyeing or acid dyeing, a similar type of after-treatment with different type of dye fixing agent and UV-absorber is to be followed for basic dyed jute to improve its wash and lightfastness. After-treatment of basic dyed jute yarns or fabrics can be accomplished using 1%–3% of suitable anionic dye fixing agent for improving wash fastness. For improving the lightfastness of dyed jute fabrics dyed with either direct or acid or basic dyes, a further after-treatment with 1% hot aqueous solution of benzotriazole (as UV absorber) in acidic medium has to be carried out either by exhaust method or by pad-dry method (Samanta et al., 2009).

2.6.4.4 Application of reactive dyes on jute

(a) Principles:

Based on the application temperature, reactive dyes are classified into two groups. One is termed as “Cold Brand Reactive Dye” as it is applied at normal ambient temperature (30°C) and the other is termed as “Hot Brand Reactive Dye” as it is applied at a temperature of 80–85°C. Cold and hot brand reactive dyes are marketed in India by different reputed companies including Atic Industries Ltd., Gujrat under the trade name of ‘Procion-M’ and ‘Procion-H’ respectively. In addition to the above two

brands, “High Exhaustion Reactive Dye” is also popular in the market under the trade name of ‘Procion-HE’. The application process of these ‘Procion-HE’ dye is similar to that ‘Procion-H’ dye. Procion-‘M’ and H, both are reactive dyes containing chlorotriazine-based reactive group. But there are some cold brand reactive dyes having vinyl-sulphone reactive groups under the brand name of ‘Remazol dyes’. Recently, fluoro-triazine-based reactive dyes are also gaining popularity for high exhaustion. Cibacron-S/SW reactive dyes from CIBA (Now changed to Huntsman) are also claimed to have higher lightfastness and are specially suitable for cotton and jute products. It is observed that though jute can be dyed with any of the M, H and HE brand of reactive dyes, some dichloro triazine dyes show relatively poor lightfastness on jute, while better overall fastness properties of bi-functional HE or ME brand reactive dyes on jute is also observed. Hence, HE brand dyes should be preferred for obtaining an eco-acceptable fastshade on jute. However, experienced dyers feel that jute can be better dyed with all round good colour fastness properties using HE brand reactive dyes following almost similar conditions applicable for cotton dyeing, but an increase in soda/soda ash to a limited extent favours deep shade dyeing of jute with HE brand reactive dyes. In case of fabric dyeing using silicate pad-batch process, either one has to reduce amount of silicate or has to avoid this process for eco-friendliness. For reducing unfixed dyes in effluent, concentration of salt and urea are to be re-optimized, low salt dyeing process for jute is to be stressed.

At the time of application of reactive dye on jute, it also reacts with water and gets hydrolyzed. Hydrolyzed reactive dye then loses its potentiality to react with the fibre and is considered as wastage. At the time of reactive dye application, in order to minimize the unavoidable reaction of the dye with water, the dye is first exhausted into the fibre as much as practicable using salt and then the preferable reaction between the dye and the fibre is brought about, by the addition of soda-ash. At the end of dyeing, in order to remove the loosely held dyes or hydrolyzed dyes from the fibre surface, the reactive dyed jute goods are to be thoroughly washed by soaping at 60°C or at boil and this process is extremely essential. Soaping after reactive dyeing is essential for removal of unfixed and hydrolyzed reactive dyes loosely remains on the fibre surface for obtaining good wash and rubbing fastness performances. Thus, soaping improves the wash and rubbing fastness of the reactive dyed goods.

Effect of different pretreatment including bleaching, on reactive dyeing of jute has been reported by Chattapadhaya et al. (2002). Also Sinha and Raymallick (2002) have reported a comparative study on reactive dyeing of jute and cotton with different types of reactive dyes.

The yarn hank/fabrics to be dyed should be free from starch, residual peroxide and alkali. The said jute yarn hanks/fabrics should be faintly acidic to neutral before taken it for dyeing. For the above reason, wherever necessary, jute yarn the hank should be treated with 0.5–1 mL/l of acetic acid solution, prior to their introduction in the dye bath. Prior treatment with dilute acetic acid solution would avoid the premature reaction of reactive dye in the dye bath.

(b) Dyeing recipe and method [Dyeing with cold brand (Procion M) reactive dye]

Table 2.6 Dyeing bath recipe according to shade depth % for cold brand reactive dyes.

Depth of shade i.e. dye % on weight of fibre-material	Common Salt g/L	Soda-ash (g/L)		
		MLR 1:15	MLR 1:20	MLR 1:30
Upto 0.5%	25	5	3	2
0.51%–2%	35	5	4	2
2.01%–4%	45	10	8	4
Above 4%	55	15	10	5

The total concentration of common salt and soda ash to be added vary with the depth of shade and fibre material to liquor ratio for reactive dyeing. The specified concentration of common salt and soda ash are given in gpl and are based on the total volumes of dye liquor. Depth of shade indicates weight of the dye to be used for colouration in percentage, on weight of fibre-material:

The following dye bath recipe (Table 2.6) and method may be followed for cold brand and hot brand reactive dyeing of jute materials:

For better understanding, the sequential steps involved in dyeing, using Procion-M type “Cold Brand Reactive Dye”, can be schematically shown in a generalized manner as follows in Fig. 2.5.

The recipe and conditions of exhaust process of dyeing of jute with HE brand reactive dye is to start the dyeing at 50°C, using required amount of common salt (30–70 g/L up to 0.5%–4% shade) in three instalments covering 30 min simultaneously raising a temperature up to 80–85°C (dyeing temperature) and the dyeing should continue at this temperature for 1.5 h adding required quantity of soda ash (10–20 g/L) in two equal instalments at 15 min interval in the first 30 min of 1.5 h. After the dyeing is over, the dyed material is to be soap washed using 2 g/L soap solution at boil for 15 min followed by normal wash.

In case of colouration with Procion H or HE brand reactive dye, the concentration of common salt and soda ash to be used for different depth of shade are given below, considering the fibre-material to liquor ratio to be considered for such application is 1:20: Requirement of salt and soda-ash for dyeing jute or cotton textiles with Procion H or HE dyes are as follows as given in Table 2.7.

The generalized schematic diagram of the sequential steps involved for colouration of jute using Procion H or HE brand reactive dyes are as follows as given below in Figs. 2.6 and 2.7.

2.6.4.5 Application of vat dyes on jute

(a) Principles

Vat dyes are water insoluble dyes and need special reduction process to solubilize before absorption on fibre interior. After solubilized vat dyes absorbed in the fibre these dyes are to be made insolubilized by oxidation either in air or by using oxidizing

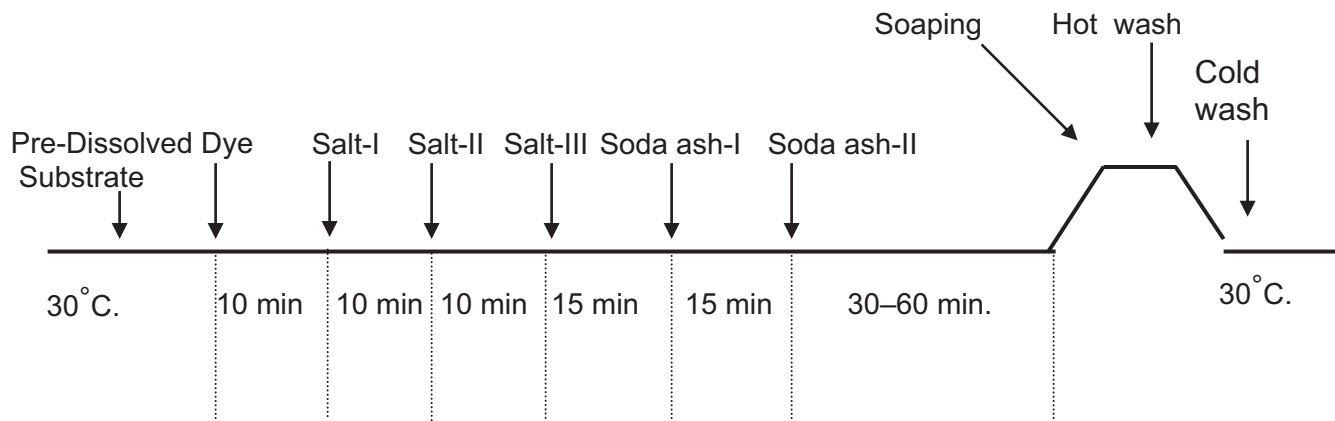
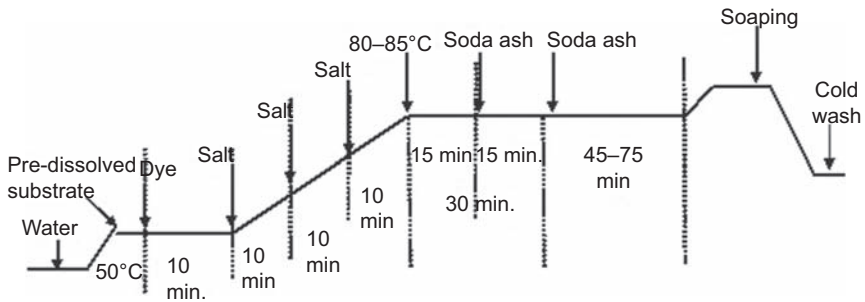
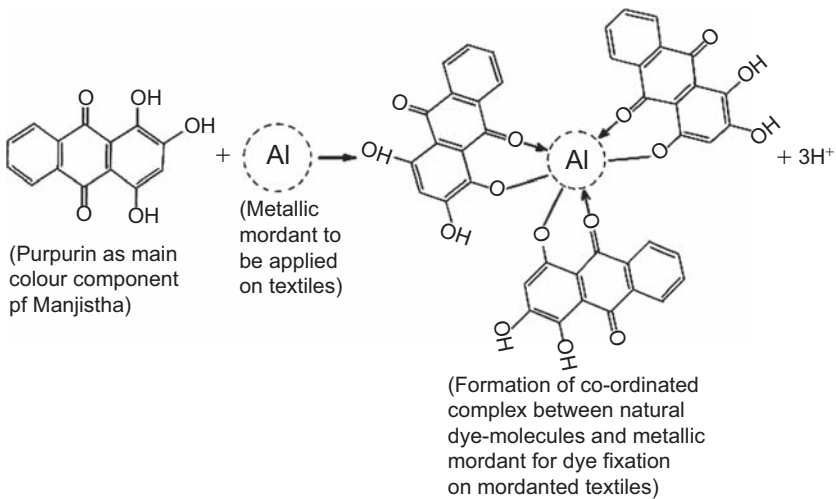

Figure 2.5 Dyeing cycle and method [for dyeing with Cold brand reactive dyes (Procion – M or ME)].

Table 2.7 Dyeing bath recipe according to shade depth % for hot brand reactive dyes.

Depth of shade i.e. dye on weight of fibre-materials	Salt (g/L)	Soda ash (g/L)
Upto 0.5%	30	10
0.51%–1%	45	15
1.01%–2%	60	15
2.01%–4%	70	20
Above 4%	90	20

**Figure 2.6** Dyeing cycle and method [for dyeing with Hot brand reactive dye (Procion – H or HE)].**Figure 2.7** Mechanism of fixation of natural dyes through mordants.

agent at suitable treatment conditions. Vat dyes ultimately remained inside the fibre structure as insolubilized form and therefore show very good all round colour fastness.

Vat dyes are costliest dyes, but considering its all round good colour fastness properties and good shade build up properties, the cost is worthy for high valued goods. Vat dyes and its application method is eco-safe and need no modification except to take care of not using excess of alkali which may raise the pH of the effluent and presence of unfixed dyes in the effluent may increase the effluent load including colour of the effluent.

(b) Dyeing Recipe (Three stage dyeing process for dyeing with vat dyes)

The normal Step by Step vat dyeing recipe applicable for jute is given below in [Table 2.8](#).

Table 2.8 Step by step vat dyeing recipe applicable for both cotton and jute.

(a) Normal vating recipe for reduction and solubilization of vat dyes (for 1 g of vat dye the following will be the recipe; hence, for higher amount of dye the recipe is to be re-calculated proportionately)	
Dye (to be pasted with wetting agent)	- 1 g - 0.5–1.0 mL.
Non-ionic wetting agent or TRO (10%)	- 1.5–3 g (preferably 2 g) - 2–3 g (preferably 2 g)
Caustic soda (solid) - Sodium hydrosulphite (hydrose)	- 50–100 cc (preferably 80 cc) - 60°C
Water	- 15–20 min
Temperature	
Time	
(b) Dye-bath recipe	
Solubilized vat dye (leuco-vat) solution	- As per shade % - 2–15 gpl (depending on the type of vat dyeing methods i.e. IN, IK, IW and IN special)
Caustic soda	- 2–9 gpl (- do -)
Hydrose glauber salt (for IK and IW process only)	- 5–30 gpl
Dispersing agent and/or Levelling agent	- 0.5 -1gpl - As required to maintain MLR
Water dyeing temperature	- 50–60°C for IN process, 45–50°C for IW process, 20–25°C for IK process and 70–80°C for IN special process
Time	- 1 h
(c) Recipe for oxidation (if not oxidized in air for longer time air exposure)	
Oxidizing agent	- 1–2 gpl sodium dichromate at 40°C for 10–15 min or 3 mL/L H ₂ O ₂ (50%) at 50–60°C for 20–30 min
Additives in oxidation bath	2.5–10 mL/L acetic acid

Vat dyes are marketed under the trade names of Indanthrene, Novatic, Cibanon etc. They are available in different particle sizes, i.e. powder, finely dispersed powder, colloisol or FD grains.

The traditional dyeing procedure and condition using above recipe for vat dyeing of jute is to keep an initial temperature of dye-bath at 25–50°C (as per dye type and dyeing method of vat dyeing to be followed i.e. IN, IK, IW and IN special process) and then to add the solubilized vat dyes and required quantity of caustic soda and hydrose (as per shade %) with or without glaubar salt (to be added for IK and IW process only) in two instalments simultaneously raising the temperature if required, to achieve higher dyeing temperature i.e. 70–80°C or so for IN special process or to continue dyeing at this temperature for 1 hour. After dyeing is over, the dyed goods are to be oxidized using above recipe followed by 1-2 gpl nonionic soap wash at boil for 15 min followed by normal wash and drying. Thus, vat dye application to jute or cotton is an eco-friendly process, if proper control on alkali concentration and amount of unfixd dyes can be properly maintained to reduce effluent load.

For adopting fully eco-friendly method of vat dyeing, it need to reduce the load of hydrose for reducing water pollutant load and avoiding sulphur contamination, using alternative eco friendly reducing system containing mixture of citric acid and liquid jaggery (Laga et al., 1997).

Vat dyes are often applied in standing bath particularly for dyeing of cotton or jute yarns. In many cases, the exhaustion of vat dye bath is not complete even after addition of salt. Hence, such dye baths for vat dyeing are worked continuously by replenishing the required amount of additional dye solution and other chemicals in the same dye bath for fresh dyeing of another lot of material as good amount of dyestaff and other chemicals are still left in the spent dye bath which can be utilized for next batch of dyeing, keeping the dye bath standing for lot to lot dyeing. This standing bath technique requires less addition of dyes and chemicals than a fresh bath and is therefore economical and more productive too.

No separate after-treatment as such is required after vat dyeing (Vatting → dyeing → oxidation), except exhaustive soap washing to remove unfixd and loosely held vat dyes that remains on the fibre surface to obtain good rub-fastness results.

2.6.4.6 *Application of sulphur dyes on jute*

(a) Principles

Like vat dyes, sulphur dyes are also water insoluble dyes, which need special reduction process to make it solubilized before absorption to the fibres during dyeing. After dyeing, it needs to be oxidized to its insoluble form for its entrapment inside the fibre in insoluble form. Some particular shades are very popular with sulphur dyes like sulphur black.

However sulphur dyes offer limited shade range. Sulphur blacks are fast to light, but sulphur yellows lack fastness to light, sulphur browns, olives and oranges are not very fast to light. For most of the sulphur dyes, the colour fastness to chlorine containing bleaching agents is very poor. Sulphur dyes are economical and are not that costly like vat dyes. Sulphur black is widely used in industry to obtain JET Black colour.

(b) Dyeing Recipe (for Dyeing with Sulphur Dyes)

The conventional recipe and conditions of sulphur dyeing for jute may be similar to that of application of sulphur dyes to cotton, which is shown below in [Table 2.9](#):

The conventional dyeing procedure and condition using above recipe for sulphur dyeing of jute is to keep an initial temperature of dye-bath at 50–60°C and then to add the solubilized sulphur dyes and required quantity of glaubar salt (in all shades of sulphur dyes salt is not required, as it may alter the original shades) to be added in two instalments simultaneously raising the temperature to 90°C and to continue dyeing at this temperature for 1 hour. After dyeing is over, the dyed goods are to be oxidized using above recipe followed by 1-2 gpl nonionic soap wash at boil for 15 min followed by normal wash.

(c) After-Treatments (After Sulphur dyeing)

The fastness to light and washing can be improved simultaneously for sulphur dyed goods by after treating the same with a mixture of potassium dichromate (for improving wash fastness) and copper sulphate (for improving lightfastness) in presence of acetic acid at 60 °C for 30 min. However, in the present context of environmental awareness, uses of copper sulphate and potassium dichromate are not considered suitable, as copper and chromium heavy metal contamination are objectionable for eco-friendly textiles beyond a certain limit.

Table 2.9 Conventional recipe and conditions of sulphur dyeing for jute substrate.

Reduction and solubilization of sulphur dye	Recipe for dye-bath preparation	Recipe for oxidation after dyeing
Nonionic wetting agent –0.5 gpl	Nonionic wetting agent –2.5 gpl	1-2 gpl hydrogen Peroxide (30%)
Sulphur dye - x%	Soda ash –2.5 gpl	And soda ash as required. OR
Sodium sulphide flakes - x%	Glucose - 2.5 gpl	1-4 gpl sodium dichromate
Soda ash - x/2%	Sodium sulphide flakes- 5 gpl	And 1–4 gpl acetic acid (80%)
(Heating if required to keep at 70°C for 20 min)	Glauber salt - 7.5 gpl (to be added later at 60°C)	At 60–80°C for 15 min
	Solubilized dye solution - as required MLR - 1:20 in vat for yarn and 1:5 in jigger for fabric	

Sulphur dyes possess great affinity for basic dyes and act as mordant for them. Hence, sulphur dyed goods are topped or after treated with basic dyes to get brilliant shades of desirable tones etc. However the topped shades possess the lightfastness grades of the basic dyes, which are sometimes low or unsatisfactory.

Sulphur dyed goods often show two major problems i.e. Bronziness in shades and Tendering of cloth after storing. To reduce or partially prevent these two problems, sulphur-dyed goods need suitable after-treatments. Bronziness caused due to excessive unfixed dyes and sulphur deposition, can be easily removed by either treating the dyed goods in boiling soap solution or in strong sodium sulphide solution at boil. Free sulphur generated from sulphur dye may be converted slowly to sulphuric acid on storage of sulphur dyed goods, which degrades or tenders the cotton or jute substrate by hydrolysis of cellulose. The sulphur dyed goods therefore need to be after-treated with dichromate, thus pre-oxidizing free and chemically active sulphur and removing the oxidized products by rinsing and washing well before storing. It is also desirable to give a mild alkali finish on the sulphur dyed goods without rinsing and washing in order to minimize any mineral acids as it is formed.

Sulphur dye effluent from traditional dyeing system contains sulphides, residual organics, unfixed dyes etc. and generate H_2S to increase effluent load and results high COD value of effluent. Hence, for adopting fully eco-friendly method of sulphur dyeing, it need to reduce the load of sodium sulphide for reducing water pollutant load in dyeing effluent and more preferably sodium sulphide has to be avoided to avoid sulphur contamination, using alternative eco friendly reducing systems. For eco-friendly dyeing bleached jute with sulphur dyes, Laga et al. (1997) have suggested to use 0.04% citric acid hydrolyzed liquid jaggery (using 2.5 times on the weight of the dye) for 2% shade instead of sodium sulphide, for reduction of sulphur dye, as an eco-safe and pollution free reducing system. This reducing agent is equally suitable for sulphur dye printing on jute. While, another report has suggested (Lokhande and Dorugade, 1998) to use glucose – NaOH system as reducing agent for sulphur dyeing or printing of jute (using 3 times that of the weight of the dyestuff used for 2%–4% shade).

2.6.4.7 Application of natural dyes/colours on jute

(a) Principle

Production of synthetic dyes is dependent on petrochemical source and some of the synthetic dyes contain toxic/carcinogenic amines and are not eco-friendly. Contrary to this, most of the natural dyes (with few exceptions) are usually based on vegetable/animal/mineral origin, renewable, biodegradable, and eco friendly (Gulrajani and Gupta, 1992; Samanta et al., 2003). Most of them are usually non-toxic/non-carcinogen and non-allergic. However the practical drawbacks of natural dyes are its non-reproducibility, non-uniform shades, poor to moderate colour fastness (not in all cases) and non-availability of standard application methods (Samanta et al., 2003). There are many reports available in literature on scientific studies related to application of natural dyes on silk, wool and even on cotton, while reports on application of natural dyes on jute and standardization of dyeing process variables for application of different natural

dyes on jute are rather scanty (Gulrajani and Gupta, 1992; Samanta et al., 2003, 2006, 2007, 2008c,d; Samanta and Agarwal, 2008; Samanta and Agarwal, 2009a,b,c).

Natural dyed textile goods have a special niche market particularly in export market as eco-friendly textile products and hence are its importance. Many small scale export houses for cotton, silk and woolen textiles are regularly using natural dyes for manufacturing their speciality eco-friendly textile products. For exportable decorative jute furnishings, convertible jute diversified decorative products, use of natural dyes is recently gaining high impetus for creating newer strata of market potential in niche market for value added eco-friendly jute products.

Most of the natural dyes have no substantivity on textile fibres without the use of a mordant compound. The majority of natural dyes need a mordanting chemical (preferably metal salt or suitably co-ordinating complex forming agents) to create an affinity between the fibre and the dye or the pigment molecules of natural dyes. These metallic salts as mordant form metal complexes with the fibres and the dyes. After mordanting metallic salts on the fibres, the metal salts anchoring to the fibres, attracts the dye/organic pigment molecules to be anchored to the fibres and finally creates the bridging link between the dye molecules and the fibre by forming co-ordinating complexes, e.g. aluminium sulphate or other metallic mordants anchored to any fibre, chemically combine with certain mordantable functional groups present in the natural dyes and bound by co-ordinated/covalent bonds or hydrogen bonds and other interactional forces as shown below:

Thus, for proper fixation of natural dyes on any textile fibre, mordanting is essential in most of the cases. The said mordanting can be accomplished either before dyeing (Pre-Mordanting), or during dyeing (Simultaneous Mordanting) or after dyeing (Post-Mordanting).

Unlike cotton, jute has some extent of affinity for some of the natural dyes, due to presence of a little extent of free carboxylic acid group in jute. So, mordanting is essential in cotton for creating affinity for natural dyes, which may be sometimes optional for jute in some cases. However, mordanting (pre-simultaneous or post) usually deepens surface colour strength and also strengthens colour fastness properties, in case of pre-or simultaneous mordanting. While, post-mordanting also may improve colour fastness, but may change the tone of colour.

(b) Extraction of dye liquor from natural dyes

The natural dyes sourced from either flowers, stem or wood, roots, bark, animals or minerals need to be extracted in any fluid medium so that it can be applied suitably on textiles. Natural dyes of different origin has to be extracted using aqueous media (Gulrajani and Gupta, 1992; Samanta et al., 2003, 2006, 2007, 2008c,d; Samanta and Agarwal, 2008; Samanta and Agarwal, 2009a,b,c; Samanta, 2014) with or without addition of acid/alkali/alcohol or using supercritical fluid extraction or alcoholic/organic solvent and finally need to be filtered, evaporate and to dry (Samanta and Agarwal, 2009a,b,c). Nowadays, there has been commercially viable industrial methods available for extracting colour components/purified colour substances from natural dyes for their ready and easy applications on textiles.

As per few research reports (Samanta et al., 2006, 2007; Samanta et al., 2008d; Samanta, 2014), the optimized conditions of aqueous extraction of few selective natural dyes applicable for jute are as follows:

- MLR-1:20 at 80°C for 90 min for extraction of Red sandal wood in aqueous medium
- MLR-1:10 at 100°C for 30 min for extraction of Jackfruit wood in aqueous medium
- MLR-1:20 at 80°C for 45 min for extraction of marigold in aqueous medium
- MLR-1:20 at 90°C for 45 min for extraction of manjistha in aqueous medium
- MLR-1:20 at 100°C for 120 min for extraction of babool bark in aqueous medium
- MLR-1:20 at 100°C for 120 min for extraction of sappan (Red) wood in aqueous medium

(c) Mordanting

For fixation of natural dyes, mordanting is essential in most of the cases. Among different techniques of mordanting, pre-mordanting has been found to be disadvantageous for jute fabrics. Moreover instead of single mordanting, a selective double mordanting has been found to give better dyeability and dyeing performances in jute fabrics. It is reported (Samanta et al., 2007, 2008c,d; Samanta and Agarwal, 2008; Samanta and Agarwal, 2009a,b,c; Samanta, 2014) that either single mordanting with 20% Al_2SO_4 or preferably double pre-mordanting using 20% harda (myrobolan) as first mordant followed by 20% Al_2SO_4 or 20% FeSO_4 as second mordant on 3% H_2O_2 bleached jute fabric renders maximum colour yield for red sandal wood, jackfruit wood and their compatible mixtures with other natural dyes, when applied on bleached jute fabrics. The mechanism of complex formation and fixation of natural dyes with mordant to selected fibre is shown in Fig. 2.7.

The methods of such double mordanting of jute fabric is as follows:

Myrobolan (Harda) powder (as natural mordanting assistants) need to be presoaked (12 h) to obtain aqueous myrobolan gel, which is to be diluted to a desired concn. (20% w/w) and finally is to be filtered before application on bleached jute fabrics by exhaust method using MLR- 1:20, temperature- 80°C and time – 30 min, before final drying in air without washing, to make it ready for either second mordanting and/or dyeing with natural dyes. For further chemical mordanting, the unmordanted or first mordanted jute fabrics fabric is to be further treated with aqueous solution of 20% (w/w) selective chemical mordant (20% Al_2SO_4 or 20% FeSO_4) by exhaust method using MLR- 1: 20, temperature- 80°C and time – 30 min, before final drying in air without washing, to make it ready for subsequent dyeing with natural dyes.

(d) Method of dyeing with natural dyes

Exhaust method of dyeing jute are almost similar to that applicable for dyeing the same with synthetic dyes except additional steps of extraction of dye from source and metallic or other pre-mordanting of fabric substrate. However, it only differs in three ways i.e. (i) necessitating additional process of mordanting, (ii) necessitating additional process of extraction of dye liquor from natural dye sources and (iii) shade application % for natural dyes are expressed on the basis of percentages of solid dry dye-source material of natural dyes taken for extraction and/or dyeing.

As per few research reports (Samanta et al., 2006, 2007; 2008c,d; Samanta and Agarwal, 2008; Samanta and Agarwal, 2009a,b,c; Samanta, 2014), the optimized

Table 2.10 Optimized conditions of dyeing with selective natural dyes for suitably double pre-mordanted bleached jute fabrics.

Name of natural dyes	Dyeing conditions					
	Temp, °C	Time, mins	MLR	pH	Salt, g/L	Sodium Carbonate g/L
Red sandal wood	80	60	1:20	4.5–10	10	As required
Jackfruit wood	100	60	1:20	11	10	—
Manjistha	100	60	1:50	4.5	10	—
Mariegold	100	60	1:50	2.5	10	—
Babool	100	60	1:50	4.5	10	—
Sappan wood	100	60	1:50	4.5	10	—

conditions for exhaust process of dyeing with selective natural dyes on suitably/selectively double pre-mordanted bleached jute fabric using above mentioned extracts of natural dyes are as follows as given below in [Table 2.10](#):

In each case, after the dyeing is over, the dyed samples are to be repeatedly washed with hot and cold water and then to be dried in air. Finally, the dyed samples are to be subjected to soaping with 2gpl soap solution at 60 °C for 15 min, followed by repeated water wash and drying under sun.

- (e) Improvement of colour fastness by application of cationic dye-fixing agents and UV-absorbers

Jute fabric samples dyed with selective natural dye extracts (40%–80% extract on the basis of weight of solid and dry dye-source material), are to be padded (using two bowl lab. padding mangle) with an aqueous solution of 2% Cetrinide or 2% CTAB (Cetyl-trimethyl ammonium bromide) or 2% Sandofix-HCF for improvement of wash fastness ([Samanta et al., 2007, 2008c,d](#); [Samanta and Agarwal, 2008](#); [Samanta and Agarwal, 2009a,b,c](#)).

For improvement of lightfastness ([Samanta et al., 2009, 2007, 2008c,d](#); [Samanta and Agarwal, 2008](#); [Samanta and Agarwal, 2009a,b,c](#)), the selective natural dyed jute fabrics are to be padded with 1% benzotriazole (pre-dissolved in hot water at 60°C) separately in presence of 0.5% NaOH maintaining 100% wet pick up in the fabric by 2 dip-2nip process followed by drying cum heat treatment at 100°C for 15 min using laboratory hot air stenter.

2.6.4.8 Developments in dyeing of jute

The major problem in dyeing of jute is to obtain good light fast dyes for its inherent photo-yellowing propensity. Jute being naturally varying in colour, it poses difficulty in colour matching particularly for light shades.

These two problems i.e. poor lightfastness and difficulty in colour matching for lighter shades have been studied by some research groups, from which the following outcome are worth mentioning:

- (a) Improving colour-fastness properties of different classes of dyes applied on 2% H₂O₂ bleached jute fabrics by selection of appropriate direct and other class of dyes with a shade card along with fastness results for jute fabric are available (Shade, 1990) from IJIRA. Only 60% of the total synthetic dyestuff available can be applied judiciously to jute to achieve desired level of colour fastness on jute.
- (b) Different dyeing process variables/factors for optimization/standardizing different colour parameters/tolerances, human perceptance and instrumental judgement of acceptability level of colour uniformity/non-uniformity has been studied by a research Group of IJT (presently DJFT, University of Calcutta) and they have prepared the standard database for application of direct dyes and other class of dyes on jute for effective colour matching (Samanta and Das, 1992).
- (c) Some energy saving dyeing and Simultaneous dyeing and finishing processes developed are as follows:
 - (i) Combined scouring and dyeing of jute with acid, basic and direct dyes having advantages of savings in process time, heat energy and water consumption.
 - (ii) Combined bleaching and direct dye application in single bath process consists bleaching of jute fabric using 1 vol. H₂O₂ for 1 h at 90°C at pH 10 with usual additives followed by dyeing in the same bath, bringing down the temperature of bath to 70°C to add 2 gpl sodium hydrosulphite and after 5 min to add 2% (owf) direct dye and 10 gpl sodium sulphate to continue dyeing for 1 h at 90°C before final washing. The colour yield obtained is at par with that obtained in conventional two step bleaching and dyeing method to obtain better wash fastness results. Single bath bleaching and dyeing of jute with direct dyes having advantages of savings in process time, steam, electrical energy and water consumption
 - (iii) Cold pad batch method of bleaching and dyeing of jute having the advantages of (i) higher productivity than conventional batch dyeing, (ii) optimum use of dyeing equipment, and (iii) energy saving (as no heating is required) and saving in water consumption. Hence, this process is very much suitable for decentralized sector.
 - (iv) Single bath bleaching and dyeing of jute fabric using sodium chlorite bleaching and 1:2 metal complex dye in combination with intermediate addition of 5 gpl sodium bisulphite has been also reported, rendering satisfactory results.
 - (v) Studies on the effects of pre-treatment on jute fabric with 6%–18% caustic soda solution (with varying level of tension or in slack conditions) on dyeing behaviour using direct, basic and reactive dyes reveals that caustic pre-treatment under slack conditions increases both direct and reactive dye uptake and decreases basic dye up-take along with some inevitable weight losses.

However, all the above said processes are applicable for selective dyes only and these methods are not commonly applicable for all types of dyes.

Due to identified toxicity of 22 selective amines releasable from some azo-dyes, there is eco-ban for certain direct dyes, acid dyes, basic dyes and azoic colour (hence, so far, total 112 such dyes are banned in India and many other countries) which excludes them for use in textile or jute dyeing. So, for producing eco-friendly textile products, only eco-safe dyes are to be used excluding those banned dyes. Among all synthetic dyestuff, almost all the reactive dyes, vat dyes as well as most of the natural

dyes (except a few) are eco-safe dyes, which may be safely used for jute or any other cellulosic textiles. For reducing pollution load in the disposable dyebath effluent (waste dye liquor), certain dyeing auxiliaries/additives are also to be avoided or to be reduced. Hence, conventional dyeing processes of jute have been reinvestigated by many researchers for development of eco-friendly processes of dyeing of jute. The present trend of searching eco-friendly dyeing process of jute encouraged many researchers to study different dyeing variables and to standardize or to develop suitable methods for dyeing jute with selective eco-safe natural dyes (though all natural products or natural dyes may not be eco-safe).

2.6.5 Pigment printing of jute

Jute fabrics can be printed with all dyes suitable for dyeing jute. However, jute fabrics are usually printed by pigment colours in direct style using kerosene or white spirit or mineral turpentine oil (MTO)-based emulsion thickener and Fixer-CCL (melamine formaldehyde resin) for improving rubfastness. Kerosene or MTO gives off bad smell, causes air-pollution and affects the aroma of the contents of such printed bags. Use of Fixer-CCL or this type of formaldehyde containing resins as fixer/property improver in pigment printing, is not eco-friendly for its releasable formaldehyde content.

Pigments may be an organic or inorganic chemical, most of them are insoluble in water, have no affinity for textile substrates. Pigment colour is fixed or held on the fibre surface by a polymeric film of binder, anchored to the fabric surface, by either self-cross-linking of binder or external cross-linking between binder and fibre.

The binder plays an important role in pigment printing which binds the pigment colour by self-cross-linking or external cross-linking with fibres in some cases. Binder also determines the brightness of the prints and its colour fastness properties. During the curing process, the binder gets cross-linked (either self or external) in presence of an acidic catalyst like diammonium phosphate (DAP). DAP liberates phosphoric acid at curing temperature which gives desired pH liberating acid or proton for cross-linking reaction.

Kerosene oil in water emulsion is used as thickener which gives the desired viscosity for print paste on subsequent drying, both the kerosene oil and water evaporates leaving behind a clear binder film. Urea is used additionally as a hygroscopic agent. As Kerosene oil-based thickener leaves behind an undesirable odour and this is a petroleum-based oil, substitute of kerosene oil-based emulsion thickener is felt necessary. Replacing kerosene oil-based thickener by polyacrylic acid-based synthetic thickener has been started commercially.

However, for printing attractive/decorative and fancy designs in jute fabrics, the hairs on the surface of jute fabric are to be removed well, fabric is to be closely woven with uniform and finer yarns and ultimately newer and abstract design development is essential for more and more customer's acceptance. Hence, IJT has recently created a print design library suitable for fancy printing designs on jute fabrics, the service of which may be catered to the users/industry/small-scale-entrepreneurs on request.

2.6.6 Chemical finishing and allied processes for jute

2.6.6.1 Softening of jute-based fabrics

A noticeable extent of improvement in softness, feel (handle) and drapability of jute-based fabrics achieved by a treatment with a dilute aqueous solution of sodium hydroxide at room temperature or at an elevated temperature followed by cationic softener or polyethylene emulsion treatment. Conventional H_2O_2 bleached jute fabric treated with 5% NaOH at room temperature for 1 hour followed by treatment with 3% polyethylene emulsion by pad-dry technique results drape coefficient to become 53 from 92 (that of control bleached jute fabric). But NaOH treatment after bleaching impairs the whiteness of bleached jute to some extent. Hence, sequential chemical texturing (by NaOH) and H_2O_2 bleaching (STB Process) developed (Ghosh et al., 1994; Samanta and Ghosh, 1996), followed by necessary finish with commercial softener or crease resistant agent etc. may be much better in such cases. Among the softeners, cata-softener is most economical but it causes yellowing on bleached jute and changes tone for dyed jute fabrics. Hence, present trend in industry is to apply 1%–2% amino-silicone softener or poly-oxo-ethylene emulsion on bleached jute fabric by pad-dry technique. Amino-silicone or other organo-modified silicone softener reduces the stiffness, bending rigidity and co-efficient of friction as well as it improves the resiliency, drape and handle property of jute fabric to a much desirable direction. However, amino-silicone softener treatment, if cured, sometimes develops rigidity for cross-linking and impairs the wash fastness of direct dyed jute materials after curing, perhaps due to desorption (coming out) of direct dyes at curing temperature. Amino-silicones do not improve resistance to fibre shedding. The organo-modified amino silicone softeners are not being widely used for jute for some drawbacks as mentioned and also it is costlier than cata-softeners and poly-oxo-ethylene emulsion softeners 2% poly-oxo-ethylene softener treatments renders jute a better softening action than any other single softener at comparable doses, if the same is applied on partially oxidized (by 1%–2% $\text{K}_2\text{S}_2\text{O}_8$ pre-treatment) or 5%–10% NaOH pre-treated and conventional H_2O_2 bleached jute fabric.

For bio-chemical softening of jute fabric by enzyme treatment has suggested the application of mixed enzyme (cellulase, xylanase and pectinase in combination of 35, 96, 135 unit per ml respectively) using 4% (owf) enzyme concentration at 55°C for 2h at pH 4.8–5.0 after pre-treating the jute fabric with 5% or 18% NaOH solution, or after conventional H_2O_2 bleaching (Samanta et al., 2005).

Though enzyme treatment before bleaching resulted in marginally improved whiteness, but if enzyme treatment is carried out after bleaching, a better bio-polishing/surface smoothening effect is obtained, as an additional advantage, despite a marginal decrease in whiteness index due to possible back staining effect.

2.6.6.2 Finishing for improved abrasion resistance and fibre shedding

To improve the resistance to the fibre shedding and abrasion on jute fabric, a few selective resins, elastomers, cellulose gum or acrylic co-polymer can be used. Reported

(Sengupta and Radhakrishnan, 1972a,b) application doses of different chemicals to reduce fibre shedding of jute fabric are 5% butadiene acrylonitrile, or 5% polyacrylate emulsion, or 0.2% carboxymethyl cellulose etc. Among the above, butadiene acrylonitrile gives satisfactory results to reduce fibre shedding and to improve abrasion resistance. Carboxymethyl cellulose also improves both fibre shedding and abrasion resistance, but it makes the fabric stiffer. Chemical dehairing and light fast bleaching (CDB-Process) developed by IJIRA is another alternative for reducing hairs on jute fabric (IJIRA, 1977). Moreover, 2%–8% acrylic copolymer emulsion (e.g. Ahuracyl-PVN) without or with suitable resin treatment on differently bleached jute or jute/cotton union fabrics improves abrasion resistance and anti-fibre shedding property.

Abrasion resistance and fibre shedding are two separate properties closely inter-related. Both these properties can also be improved on jute fabrics by application of 8% polyvinyl alcohol (PVA) or by 8% application of 1:1 (w/w) mixture of PVA (NaIO₄ treated) and polyethylene glycol (PEG 400) in presence of Al₂(SO₄)₃ as catalyst employing a pad-dry-cure technique. In the only PVA treatment, abrasion resistance cycle become 71 from 41 that for untreated fabric and fibre shedding become 5mg from 24mg, with wrinkle recovery angle as 155° from 136°. In case of application of mixture of PVA and PEG (1:1), it shows fibre shedding to be 10.2, abrasion resistance cycle to be 63, with wrinkle recovery angle as high as 258° from corresponding parameters of untreated fabric (Ghosh and Das, 2000; Bagchi and Som, 1999).

2.6.6.3 Finishing to improve crease resistant property

Like cotton, crease-resistant property of jute fabric is also poor. Hence, processes have also been developed to improve crease resistant property by many researchers. A typical recipe for ordinary crease resistant finish application on jute fabric is to apply DMDHEU— resin-8%, MgCl₂ catalyst –2%, Polyethylene emulsion (softener)-1%, Silicone-emulsion or Polyoxyethylene emulsion (softener) –1% following application process of Padding [at 100% expression] → Drying [100°C for 10min.] → Curing at [130°C for 5 min] → washing [with 1gpl detergent at 50°C for 15 min] → Normal water washing → Final Drying [at 100°C for 10–15min.].

The Above said crease resistant finishing has formaldehyde release problem due to use of Di-Methylol Dihydroxy Ethylene Urea (DMDHEU) or similar methylol-based cross-linking resin (Som et al., 1987a,b). A newer method for application of low formaldehyde content resin (N-methylol acrylamide or acrylamide formaldehyde resin) on jute fabric has been reported employing simultaneous free radical polymerization and acidic poly condensation under dual catalyst (MgCl₂ and K₂S₂O₈) system in control doses on jute fabric (Ghosh et al., 1997), on Jute/Viscose (60:40) blended fabric (Ghosh et al., 1994) and on Jute/Cotton union (75:25) fabric (Samanta and Ghosh, 1996) to obtain a better balanced textile related properties in each case.

An exclusively separate approach developed (Chattopadhyay et al., 2001) in resin finishing of jute fabric is to pre-treat the jute fabric by 4% (owf) mixed enzyme (cellulase, xylanase and pectinase) before 8% DMDHEU resin treatment to obtain 25%

increase in crease recovery angle and also for pre-reduction of stiffness in the fabric owing to be generated due to resin treatment.

Recent developments (Ghosh et al., 1995) in formaldehyde free crease resistant finishing of jute fabric by using Citric Acid as Cross-linking agent as formaldehyde free cross-linking agent under sodium di hydrogen phosphate catalyst system has been established for producing ester cross-linkages in jute fabric by pad-dry-cure process using citric acid as a formaldehyde free cross-linking agent, in presence of $\text{Na}_3\text{PO}_4/\text{NaH}_2\text{PO}_4$ catalyst which has produced a moderate to good crease resistance property as well as enhancement in rot-resistance and some resistance to photo-yellowing along with higher tenacity retention and better lightfastness property for basic dyes, if dyed fabric is used.

2.6.6.4 *Finishing to improve rot resistant property*

Earlier developed rot resistant finish of jute fabric (Samanta, 1995) employing copper salts and soda, copper naphthanate (0.5% copper) or copper pentachlorophenate or copper-8-hydroxy quinoline, tributyl tin oxide etc. are not eco friendly and copper develops dark colour. Most of them are not durable type. Recent developments for imparting durable rot resistancy of jute has been reported by different researchers employing phenol/formaldehyde compound on oxidized jute (Ghosh and Dutta, 1988); and employing citric acid cross-linking treatment on jute (Ghosh et al., 1995).

However, considering the fact that jute is being used as soil saver and other types of geo-technical applications in moist/humid conditions under soil, coating of jute fabric with ordinary bitumen or with emulsified mixture of bitumen and water repellent compounds including some hydrophobic polymers and/or wax emulsion etc. are much economical and commonly acceptable to the user industry.

Use of Citric acid and PEG combination (Samanta and Bagchi, 2012) has been reported to be an economical rot resistant Finish of Jute Fabric though Citric acid and chitosan combination (Samanta and Bagchi, 2013) is also reported to be equally good and eco friendly rot resistant finish for jute fabrics.

2.6.6.5 *Finishing to improve water repellent property*

Conventional methods (Samanta, 1995) of application of water repellent finish using 10%–20% (owf) stearato chromic chloride complex at pH-4.0 or wax emulsion and aluminium stearate separately or in combination had main drawback of their non-durability.

In the context of jute to be used as technical textiles for weather resistant tent fabric, water proof and stain repellent floor mat and soft luggages etc., its demand for water repellent finish is rated to be high. For durable water repellancy, 2%–6% (owf) textile-water repellent grade commercial dimethyl silicone emulsion mixed with hydrogen-methyl silicone (60:40) with in built catalyst, having viscosity about 12,500 cps (at 25°C) has been recommended for application on jute fabric by pad-dry-cure technique (Samanta, 1995). However, silicone emulsion is costly and has lower storage stability.

It is reported in literature (Bagchi and Som, 1999; Basu and Mitra, 1993) that the efficacy of commercial fluoro-silicones (Fluoroguards) as water repellent agent for jute fabrics and developed a recipe comprising 1% Fluoro-silicones with 10% DMDHEU resin to be applied by pad-dry –cure technique to obtain water repellency rating as high as 90 with crease recovery angle of 256 degrees.

2.6.6.6 *Finishing to improve fire retardant property*

Treatment with borax and boric acid (7:3 ratio) with or without phosphate compounds for fire retardant finish of cellulosic fabrics is common (Samanta, 1995), but most of them are non-durable in nature and less effective. For mining and military applications, a treatment has been reported in literature using 25% aqueous solution of mixture of borax and boric acid (7:3) to obtain a flame retardancy on jute fabric (Bhuiyan, 1986; Samanta et al., 2011) to a level to get limited oxygen index value of 35 from LOI value of 20 of untreated jute fabric, but is not durable one. A semidurable flame retardant finish on jute fabric has been reported earlier by applying organo phosphates with or without urea or any other such fire retardant compounds along with N-methylol resin (melamin formaldehyde) i.e. phosphorous nitrogen system applicable for jute-based ligno-cellulosics to produce acceptable fire retardant effect (Bhuiyan, 1986; Samanta et al., 2011). There is a recent past report (Samanta et al., 2015) for achieving semi-durable fire retardant finish on Jute Fabric using 15% Ammonium sulphamate and 15% Urea with a commercial binder [5% Acrylic binder (Arco fix) +3% ceralube combination] to achieve LOI around 36 to 38.

Another recipe for five wash cycle durable fire retardant finish of jute fabric has been reported with application of 0.01% of nano ZnO with 10% PMS or PHAMS (poly hydroxyl amino methyl silicone or its potassium salt) binder (Samanta et al., 2017c) achieving LOI value of 35.

Fully ecofriendly and wash durable fire retardant finish has been developed recently by applying 20% Stannate and 20% Boric acid (Samanta and Bagchi, 2017) by pad dry cure technique to achieve LOI value of 34 with some loss of strength around 14%–15%.

More detailed information on Flame retardant finishing of Natural fibres are available in Chapter 10, Volume–2 of this handbook for further reference.

2.6.6.7 *Simultaneous dyeing and finishing in single bath*

Simultaneous dyeing and Finishing Process has also been adopted for jute-based fabrics, which is an energy saving approach (Samanta, 1995; Bagchi et al., 1990; Samanta et al., 2008e), by developing suitable process for simultaneous single bath dyeing and resin finishing process for jute fabric using different dyes. But these processes are applicable only for selective class of dyes, matching with the condition (acidic pH) of resin finishing.

Simultaneous Dyeing and Fire-Retardant Finishing of Jute Fabric Using an Acid Dye (Samanta and Bhattacharya, 2015a,b). Simultaneous Dyeing and Rot Resistant cum Crease Resistant Finishing of Jute Fabric Using Citric Acid and Poly Ethylene

Glycol (Samanta and Bhattacharya, 2015a,b) as well as Simultaneous Dyeing and Fragrance Finishing using beta Cyclodextrin, citric acid and acidic catalyst system (Samanta et al., 2016) have been reported recently for improving aesthetics and corresponding functional properties of jute fabrics.

2.6.6.8 Enzyme assisted bio-chemical finishes

Bio-polishing of cotton, as an eco-friendly bio-chemical finish of cotton by the action of cellulase enzyme to improve its aesthetic appeal, feel, softness and lustre is commonly known to every finisher. For similar finishing of Jute fabrics, types of enzymes (Mixture of cellulase and pectinase and xylanase is specifically to be used for bio polishing of Jute Fabrics considering its multiconstituent nature), bio-polishing techniques/methods and necessary conditions for jute fabric and for jute/cotton fabric (Samanta et al., 2005) has been reported, where it is found that a H₂O₂ bleaching pre-treatment or alkali (5%–10% NaOH) pre-treatment enhances enzyme activity on jute fabric.

2.6.6.9 Multi-functional finishes for jute fabric

Recently customer's demand is oriented towards development of multi functional finishes, i.e. the fabric has to be crease resistant in one hand and to be resilient on other hand or a fabric is to be water repellent cum weather resistant in one hand and stain resistant in other hand with preferably rot resistant property too. Finishing of jute fabric by 10% acrylic acid (Ghosh and Das, 1998) in presence of dual catalyst (Na₃PO₄ and K₂S₂O₈) system producing good crease resistant property (it become 238 degrees from 143 degrees that of untreated fabric) as well as anti-yellowing property (lightfastness rating become 3 instead of 1 for untreated fabric) with less hairiness and less fibre shedding (it become 9.4 mg from 34.6 for untreated fabric) is an endeavour to meet the need of multifunctional finishes.

Water repellent as well as soil resistant finish (Bagchi and Som, 1999; Samanta, 1995) can be imparted on jute fabric by a formulation developed (Roy, 1967) based on (a) aluminium sulphate, stearic acid, paraffin wax and alkyl amine etc. and by using glycerol mono stearate-based formulation with softener cum emulsion stabilizer.

Moreover, rot resistance and crease resistance finish of jute fabric can be achieved simultaneously by use of citric acid and PEG combination (Samanta and Bagchi, 2012).

2.7 Eco-friendly processing of jute

A critical examination for Eco-friendly processing of Jute including different chemical processing of jute and jute-based textiles with some suggestions are also made wherever possible.

2.7.1 Use of non-toxic (hydrocarbon free) batching oil for jute

Conventional Jute Batching Oil (JBO), a mineral oil fraction (gas oil fraction having IBP – 230–285°C and FBP – 350–370°C) usually contain certain polynuclear hydrocarbons (pyrene, chrysene, benzopyrene etc.) responds showing UV absorbance beyond a limit in UV-VIS Spectrophotometry at 280–400 nm, which are considered to be toxic hydrocarbon present in JBO. JBO also sometimes contains varying amount of sulphur (0.12%–3%). If some halogenated volatile organics are present as contamination in JBO, it is also objectionable. Also Nonyl phenol-based emulsifier/surfactant, used in preparing JBO emulsion are reported to be toxic. So, it is recommended to use a safe batching oil, i.e. toxic hydrocarbon free batching oil for jute. Such oils may be some vegetable oils. But all vegetable oils do not match the viscosity required and hence do not serve this purpose also considering cost economy and to provide standard pre-spinning and spinning process performance (Fibre droppings and fibre breaks are more). Alternatively sulphonated castor oil with small amount of silicone emulsion as suitable additive is said to give better performance than only sulphonated castor oil and hence can be used. However, IJIRA (Indian Jute Industries Research Association), India has also developed a better substitute recommending the technology for use of a particular grade of modified rice-bran oil (a vegetable oil) instead of conventional JBO.

2.7.2 Eco friendly softening of jute

Among chemical softeners, most popularly used softener for jute-based textile are cationic softener. But most of the catasoftener are not eco-friendly either for less biodegradability or for generating high COD in effluent. So, softening of jute-based textiles is to be done using 5%–10% NaOH pre-treatment. But high alkali increases pH of effluent water and is not desirable. Also acetic acid used for neutralization is a high COD compound, which should be replaced by formic acid or oxalic acid having lower COD value. Another safe alternative is enzymatic softening of jute. Different report in literature includes use of Mixture of Cellulase and Xylanase or mixture of Cellulase, Xylanase and pectinase are found more fruitful for jute instead of only cellulase enzyme at a temperature of 45–50°C for 1 hour, as a pre-treatment before usual hydrogen peroxide bleaching, resulting enhanced brightness and softness of jute fibres after bleaching.

2.7.3 Eco-friendly desizing of jute

Tamarind Kernel Powder (TKP) is the usual size for jute yarns. Moreover different size additives are also required including antiseptic/antimildew agents such as pentachlorophenol or copper sulphate, both of which are not eco-safe. Sodium silico fluoride can be used as ecosafe antiseptic agent. Also high starch content increases suspended solids in effluent after desizing. Therefore, alternative size may be hot water soluble grade polyvinyl alcohol type synthetic size replacing part of TKP, desizing of which is also easier and eco-safe. Considering higher strength of coarser jute yarn even one can think of not to use sizing at all for jute warp for weaving sacking and hessian clothes.

2.7.4 Eco friendly scouring of jute

Usually scouring of jute is avoided, as it darkens the brown colour of jute and also absorbency of raw jute fibre is considerably high, which do not require scouring. But considering the dirt, dust and acquired impurities including batching oil added in spinning of jute yarn, it sometimes needs scouring.

Ordinarily, scouring of jute yarn or fabric can be done by treating the material with 1–4 g/L sodium carbonate (approx. 2% owg effectively) and 1 g/L non-ionic detergent (Lissapol-N) at 50–60°C for 30 min followed by normal wash. This scouring process is a clean process and need no modification to make it eco-friendly.

However, jute yarns or fabric may be safely cleaned using 0.5%–1% HCL at room temperature for 5–15 min at a material: liquor ratio 1:20. Thus, brighter jute can be obtained by this dilute HCL pre-treatment avoiding alkali scouring before bleaching. However, complete de-oiling is difficult by this method.

2.7.5 Eco friendly bleaching of jute

Jute can be bleached with any one of the bleaching agents like potassium permanganate, sodium hypochlorite, bleaching powder, sodium chlorite, hydrogen peroxide, hypochlorite followed by peroxide, peracetic acid etc. Amongst all, a safe alternative for eco-friendly bleaching of jute is hydrogen peroxide bleaching of jute with some care.

Use of sodium silicate or sodium metasilicate in hydrogen peroxide bleaching as stabilizer causes the higher (alkaline) pH of effluent, and during neutralization (equalization) of effluent treatment, silicate precipitates and cause scale formation in effluent treatment plant damaging it and the drainage system. Therefore, alternative safe hydrogen peroxide bleaching of jute can be done by using organic stabilizer like sodium salt of diethylene triamine penta acetic acid i.e. Stabilizer – Awni or Stabilizer – Sifa.

2.7.6 Eco friendly dyeing of jute

The major constituents of jute being cellulose, hemicellulose and lignin, it can be dyed with any one of the direct, acid, basic, azoic, reactive, sulphur, vat and natural dyes. Direct and acid dyes on jute show poor wash fastness and basic dyes on jute so poor lightfastness, besides their problem related to possibility of release of carcinogenic amines banned. However, all direct dyes and acid dyes are not banned and all do not contain objectionable toxic amines. 112 (40 benzidine based and 72 more dyes based on 22 listed amines) azo-dyes are banned globally including India.

However, the eco-ban towards certain direct, acid, basic dyes and azoic colour components (objectionable coupling amines) as well as their overall poor dye fastness on jute fabrics, excludes them for further use particularly in export goods. So, alternative eco-safe dyes one can think are reactive, sulphur and vat dyes as well as natural dyes applicable for jute. Jute therefore can be safely dyed with these dyes with some modifications in their application procedure. For sulphur dyeing, one has to avoid sodium sulphide to make the application process eco-friendly. For reducing total

dissolved solids in effluent of dye houses, one has to use less salts and one has to achieve more fixation of dyestuff (achieving less unfixed dye and colour in effluent) following short liquor ratio particularly for reactive and vat dyeing. For vat dyeing, less alkali is to be preferred. For natural dyes, if mordanting is necessary, one has to avoid copper and chromium salts. One has to also avoid unsafe azo-dyes and has to find alternative eco-safe dyes for obtaining desired shades choosing from reactive, sulphur, vat and natural dyes with care.

2.7.7 Eco friendly printing of jute

Pigment printing is very popular for jute and other textiles. Some methylolated resin compounds (such as melamine formaldehyde in the trade name of Fixer CCL or fixing agent – 2F etc). are used as pigment fixing agent to improve rubfastness properties. These agents releases formaldehyde during use of the pigment printed fabrics. Moreover, objectionable absorbable organic halogens (AOX) and heavy metals are present as impurities in pigments from the production process. One can use formaldehyde scavenger i.e. urea as additive when methylolated type of fixing agent are used. Otherwise one has to avoid completely the use of such formaldehyde containing compounds. Kerosene used for preparation of emulsion thickener is to be avoided for avoiding air pollution and health hazards. Alternative thickener is polyacrylic acid or its esters based synthetic emulsions, but they give a bit duller shade.

Printing of jute with sulphur dyes using glucose – NaOH system as reducing agent (optimized concentration being 3 times of the amount of dye) with other condition remaining same is reported in recent literature as an eco-safe process. Also liquid – jaggery treated with 0.4% citric acid, producing sufficient amount of reducing glucose, may be used in sulphur dye printing.

2.7.8 Eco friendly chemical finishing of jute

Jute fabrics are normally treated with salts of metals such as copper, chromium, iron, antimony, cobalt used separately or in selected combination for improving its rot resistance/weather resistance etc. Very common rot resisting agents for jute are copper naphthanate, copper panta-chlorophenete and lauryl pentachlorophenate, etc. which are not eco-safe. So, safe rot resisting chemicals for jute may be hydroxy quinolate or safe quaternary ammonium type of compounds.

For softening of jute, among chemical softener, use of cationic chemicals softeners become popular. This is not completely eco-safe and not easily biodegradable. So, 5%–10% NaOH treatment or mixed enzyme treatment may be the alternatives.

For flame retardancy of jute brattice cloth used in coal mines, use of THPC (Tetrakis hydroxy-methylated phosphonium chloride) or THPOH-based fire retardant agents are not eco-safe. THPC and THPOH, both have formaldehyde release problem. Antimony oxy-chloride are also halogenated FR agent, and are not eco-safe. So, durable eco-safe FR agent may be use of tin (sodium stannate) and boron (boric acid)-based compounds.

Use of DMDHEU (Dimethylol Dihydroxy Ethylene Urea) type methylolated cyclic urea resins are to be avoided for rendering crease resistant finish on jute-based fabrics, as they have formaldehyde release problem beyond the stipulated limit. One alternative is to use N–N-Dimethylol acrylamide resin as a low formaldehyde releasing agent for cross-linking Jute and Cotton textiles. But higher % application (more than 8%) is to be avoided. As a more safe alternative, citric acid-based formaldehyde free cross-linking agent may be used on jute fabric.

2.7.9 Use of alternative chemicals having low COD/BOD values for eco-friendliness of processes and products of jute

The followings are the partial lists of some common chemicals used in chemical processing of jute which are either eco-unsafe or have high COD/BOD values. Some of the suggested alternative chemicals having eco-safe properties or atleast having lower COD/BOD values, can be used for eco-safe processes or to reduce water pollution load in the effluent, increasing the eco-friendliness of the processes or product of jute.

2.8 Diversified end uses of jute as technical textiles

Traditional processing of Jute and its common uses etc is available in first edition of Handbook of natural fibres, vol-1, chapter –2 for Bast Fibres: Jute (Roy and Lutfar, 2012). The growing disinclination to use artificial fibres and increasing preference for natural fibres may revive the importance of jute in its technical uses as Diversified Jute Products. The jute products other than traditional ones, preferably having higher value-addition, can be defined as diversified jute products. Besides some technical property parametric advantages, Jute fibre has got tremendous merit for its eco-compatibility, vegetation support, easy and bulk availability, negative health hazard, soil friendliness and ability to add of nutrients to the soil after degradation which are the major plus points for jute fibre in addition to technical merits for its different end uses in technical textiles. Moreover, heaviness (weight/unit cost) and appreciable thickness, required draping quality, ability to withstand initial stresses of road construction, stiff body preventing differential settlement on soil, high permittivity and transmittivity, irregular surface morphology preventing lateral and rotational slides, high water absorption performing well in filtration and drainage and soil consolidation (caking) functions, resistance towards abrasion, fatigue and fracture for jute-based properly designed fabrics indicate its positive prospect for its uses in technical textiles, which have not been explored earlier. The development of different diversified jute products using jute alone or in combination with other fibres has been initiated. The different popular weaving-based jute products are jute shopping bags, decorative fabrics, jute wall hangings, etc. Similarly there Jute felts and rugs from Jute non-wovens or from jute braided materials are also being popular as home textiles. Jute Floor coverings may be both woven and nonwoven jute fabrics, besides carpet backing etc.

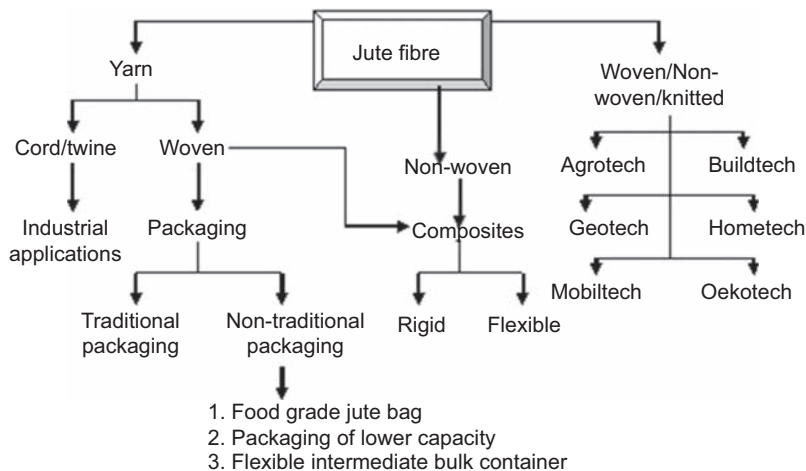

Figure 2.8 Different techniques of manufacture of technical textiles from jute.

These merits of jute fibres, not explored earlier so scientifically, if can be properly utilized may produce inexpensive technical textiles for specific end uses as different areas of technical textiles. Raw and clean Jute Fibres from India and Bangladesh are now being exported to different countries for initially making jute-based nonwoven sheet for utilizing it to make jute-based composites for manufacture of door panel and different parts of automotive car to make it partially biodegradable. Jute fibre which is abundantly available in West Bengal, Assam and Andhra Pradesh In India and also in different parts of Bangladesh will be boosting economy of farmers to jute industry provided the outlook is modified in the perspective of global preference of natural bast fibres for making composites and geotextiles. Therefore, a concerted efforts need to be made to explore design and production of marketable non-traditional jute products (for both domestic and foreign markets) as technical textiles, Fig. 2.8 shows a chart given below for its different manufacturing techniques of jute-based technical textiles.

Besides major uses of coarser and low priced jute in packaging areas, as Indian second important natural fibre after cotton, the physic chemical improvement of jute fibres/fabrics after necessary pre- and post-finishing treatment has emerged jute as an important natural textile fibres to be better suited for other technical textile applications improving value of jute fibres in market, creating benefit to farmers from the price appreciation of good quality jute fibres. This enlarging areas of application of jute will definitely enhance the price/value of raw jute cultivation to the farmers encouraging them for good quality jute cultivation and production.

Thus, besides traditional uses of jute in packaging textiles, its category-wise uses under different Technical textiles areas are: (i) Packaging textiles (Pack-tech), (ii) Geotextiles (Geo-tech), (iii) Agricultural textiles (Agro-tech), (iv) Build and structural textiles (Build-textiles), (v) Automobile-textiles (Mobil-tech), (vi) Protective textiles (Pro-tech), and (vii) Home textiles (Home-tech), i e. in seven such categories out of the 12 different categories of technical textiles. Category wise, such diversified

end-uses of jute as technical textiles are given below with specific property advantages of jute fibres suiting such technical textile applications in [Tables 2.11–2.16](#).

Suitably woven jute fabric can be conveniently coated [4] with different elastomers to have products, such as hospital sheeting (mackintosh), double texture rubberized fabric for luggage, flexible hood for automobiles, chemical resistant sheet for industrial house and many others. High strength and low extensibility, good thermal stability, irregular surface morphology of the jute fibre appears to be advantageous for producing such items.

Table 2.11 Jute packaging textiles.

Property advantages	Specific end-uses
Non-slip nature, stack stability, high strength and modulus, low extensibility, good dimensional stability, good moisture absorption and air permeability, favourable hook resistance and cut resistance, low cost and easy availability, agro-renewability, ecofriendly nature and biodegradability.	Besides conventional jute bags for packaging agricultural and industrial commodities, non-traditional jute bags includes postal bags, tea-bags, shopping bags, waste disposal bags, portfolios, carry bags, school bags, vegetable bags, collapsible/folded bags, multipurpose low-volume jute bags and soft luggages and eco-friendly food grade jute bags satisfying IJO-98/01 specifications.

Table 2.12 Jute geo-textiles.

Property advantages	Specific end-uses
High strength and modulus, good dimensional stability and ability to withstand initial stresses of road construction, heaviness and appreciable thickness, good draping quality, stiff body preventing differential settlement on soil, high permittivity and transmittivity, irregular surface morphology preventing lateral and rotational slides, high water absorption performing well in filtration and drainage and soil consolidation (caking) functions, soil friendliness and addition of nutrients to the soil after degradation, eco-compatibility, vegetation support, easy availability, low cost and agro-renewability.	Jute geo-textiles (JGT) finds its application in surface soil erosion control in slopes and plains, stability of embankments, strengthening of sub-grade soils in roads, protection of banks of rivers and waterways, sub-surface drainage, soft soil consolidation etc. Thus, JGT withstands stresses in the constructional phases, prevents intermixing of different soil layers, acting as separator, performs filtration function and also controls lateral dispersion, subsidence and slides. JGT performs five basic functions such as separation, filtration and drainage, initial reinforcement, control of surface soil detachment and vegetation or biotechnical support.

Table 2.13 Jute agro-textiles.

Property advantages	Specific end-uses
High strength and good dimensional stability, good draping quality, easy dissipation of kinetic energy of raindrops, good absorption of moisture and attenuation of wind effects, improvement of micro-climatic conditions (viz.temperature and moisture), enhancement of organic matter levels and nutrient to the soil, irregular surface morphology preventing lateral and rotational slides, high air and water permittivity and transmittivity, vegetation and bio-technical support, eco-compatibility and soil friendliness, easy availability, low cost and agro-renewability.	Jute fabrics are now being used as agricultural textiles for sun screens, plant nets, wind shield, harvesting nets, field-nets for protecting crop from birds, weed protection, mulching on seed bed, soil conservation, development of forests in semi-arid zones, nursery pots and nets etc.

Table 2.14 Jute home textiles.

Property advantages	Specific end-uses
Unique natural colour, special surface texture, hand crafted look, heaviness and smart in appearance, high strength and modulus, moderate to good draping, good moisture absorption, good bleachability, good dyeability and printability with different class of dyes, low cost and easy availability, agro-renewability, and eco-friendliness.	Natural colour/bleached, dyed,printed, and finished jute or jute/cotton unionized decorative and furnishing fabrics, wall hangings, wall decoratives, floor coverings, floor mattings, soft-luggages, aprons, hats, gloves, filecovers, footwear, tablemats, fashion accessories like laces, patchwork and braidings, gift boxes, and miscellaneous handicraft items from jute fibres, yarns and fabrics. Eco friendly jute decorative cloth and tarpaulins made out of jute or its blends.

Table 2.15 Jute protective textiles.

Property advantages	Specific end-uses
Resistance to weather and microbial attack is moderate and to some extent better than cotton due to presence of lignin.Good thermal stability and diverse chemical functionality attributes easy chemical modification on jute for protective textile finishing.	Bleached and/or dyed jute or jute/cotton union fabrics finished for fire-protection, rot-resistance, water repellancy, resistance to photo-yellowing, resistance to fibre shedding, abrasion and resistant to staining etc. are used in relevant need.

Table 2.16 Jute based build-textiles and mobil-textiles (jute-based thermoplastic and thermoset rigid and flexible composites).

Property advantages	Specific end-uses
<p>High strength, modulus and stiffness, (these parameters per unit cost are more predominantly high), heaviness (weight/unit cost is high), irregular surface morphology, moderate internal surface areas and aspect ratio (even good in elementary cell level), low specific heat and low thermal conductivity, relatively higher thermal stability and dimensional stability (prominent aromaticity and cross-linked structure of lignin provides highly rigid, isotropic, more thermally stable, non-crystalline matrix with high binding capacity through unsaturation and phenolic –OH functionality, besides highly accessible –COOH, and –OH functionality of hemicellulose and usual –OH functionality of cellulose), good resin</p> <p>Binding capacity (though higher moisture proneness poses some problems if jute is not predried at 170°C) and amenable to suitable chemical modifications to suit better compatibility with resin or thermoplastic matrix.</p>	<p>Thermoset jute rigid composites</p> <p>Rigid jute-polyester resin (thermoset) composite can be used as door and window frame for low cost house, corrugated sheet for false roof, garden canopy, garden fence, and furniture. Many product of this category are coming up to cater the need of railways and automobiles for the purpose of flooring and roofing to replace wood and plywood. Jute nonwovens and resinated felt are introduced commercially in automotive for building doors, B-pillar, A-pillar headliner, package tray, underlay carpet material, air deflector etc.</p> <p>Thermoplastic jute rigid composites</p> <p>Jute waste and recycled polyolefin composites for garden canopy/fence, street lamps etc., Jute-PP or MAPP thermo- plastic composites sheets moulded for door panels of cars. Admixed jute fibre with natural resin/adhesive like shellacs soya-resin and modified starch etc. bio-components may be produced for such applications.</p> <p>Flexible composites: Laminated/Coated flexible jute composite:</p> <p>Jute fabric may be coated with suitable polymer/elastomer to develop products such as coated tarpaulins, conveyer belt, weather resistant cover, awnings, canopy, architectural textiles, breathable aprons, mackintosh, hospital sheetings, double texture rubberized fabrics, flexible hood for automobiles etc.</p>

Jute fabric can also be lined with aluminium foil following established technique. Tea bag produced out of such jute fabric-aluminium foil laminate appears to have potential for replacement of conventionally used relatively expensive tea bag made from Kraft paper aluminium foil laminate.

Suitable woven unmodified/modified jute and/or jute-cotton and jute-polyester union fabrics may be coated with any one or a suitable blend of any two or more of

chlorinated polyethylene, chloro-sulphonated polyethylene, polyacrylates, natural rubber, ethylene-octene copolymer, aluminium foil laminate, metalized polyester etc. to develop products such as (i) coated tarpaulins, (ii) food carrying conveyer belt, (iii) awnings, canopy, (iv) compact coated textiles, (v) architectural textiles and (vi) cost effective breathable protective aprons for pesticide application (vi) bulk packaging material for any crops, tea and other dry food/agricultural commodities/products.

Coated jute products with Natural rubber latex or other materials may also be used as flexible composite materials to produce test fabrics, automobile hood/cover, canopy and tarpaulin for multipurpose uses.

In case of jute home textiles and jute diversified products, more important are its colour, surface texture, look, softness/drape and aesthetics along with its appealing or exclusive designs of the products than its functional performances. While for jute technical textiles like jute protective textiles the functional properties and performances are more important than aesthetics.

For appealing look and aesthetics of jute home textiles and diversified products and specific functional performances of jute protective textiles, jute fibres/yarns and fabrics may require specific chemical treatments/finishes to improve certain property parameter(s) as well.

2.9 Conclusions and future trends

Jute or similar nature of fibres like mesta (*Hibiscus cannabinus*), as a low cost, agro-renewable natural and biodegradable bast fibre, are abundantly grown in India, Bangladesh, Nepal, Nigeria and Kenya etc, are though majorly used as packaging textiles, but its uses as diversified technical textiles areas are growing day by day after sufficient R&D intervention to design and manufacture of Jute Woven, non-woven, braids and composites materials. Even, Manufacture of paper from Jute or Jute Stick, manufacture of activated charcoal from burnt jute, preparation of nanocrystals of cellulose from jute are newer areas of interest for further exploration of its commercialization, besides other important technical textiles of jute including Jute geotextiles, Jute agro-textiles, Jute-based build and mobil textiles, Jute home textiles etc besides its old and ancient uses as Jute packaging textiles.

Potential application of jute fibres/yarns/fabrics or its composites either woven or nonwoven or any other textile structure for its use as different technical textiles much depends on its inherent potential properties and product designs to satisfy all the end use requirement. Some of the properties of jute-based products may be improved/incorporated by proper chemical finishing and chemical modification or even by coating or laminating etc for making it suitable for better performing technical textiles.

One of the most effective potential outcomes in recent year, is development of jute-based substitute of mastic asphalt by designing and manufacturing Bituminized Jute Paving Fabric, with polymerized special grade bitumen coated multi-layered composite of jute woven and nonwoven fabric composites, which serve as an overlay as a jute-based substitute of mastic asphalt providing required reinforcement to the

road construction and enhancing thereby the life expectancy of the roads of different traffic volumes.

Design and manufacture of Jute-based agrotexile products has also facilitated a bioengineering measure for soil and water conservation and fertility enhancement of the Barren & Baid Lands, which are though less tried commercially and need to explore much in future.

Specially designed and developed Jute fabric reinforced bio-degradable geo membrane or medical disposable bags and wipes can be effectively used for pond and canal lining, municipal solid waste Management, hospital waste management, etc. Respectively. Jute fabric based combined/multi-layered Tar Felt can also be used for potential applications in civil engineering for roof treatment in particular. Use of Jute based composites for awning, false ceiling board, cover wall of railway coaches and even door panel for cars etc are of high importance now a days for diversification of jute products. So as a natural agro-renewable bast fibre, the potential of jute for all possible diversified areas are needed to be explored by suitable R&D and commercialization approaches.

2.10 Sources of further information and knowledge on jute

The following general materials for more detailed knowledge on Jute fibres and its processing and newer product designing may be consulted for further reading, besides the specific references cited at the end.

References

- AATCC report. Text. Chem. Colorist 2, 1970, 361.
- Abdullah, A.B.M., Miles, L.W.C., 1984. Text. Res. J. 54, 415.
- Abdullah, A.B.M., Miles, L.W.C., 1985. J. Text. Inst. 76, 415.
- Achwal, W.B., August, 1995. Colourage 37.
- Achwal, W.B., Sinkar, U.W., 1993. Ind. J. Fibre Text. Res. I 18, 192 and Part-II : 19, (1994) ,30.
- Achwal, W.B., Sinkar, U.W., 1994. Indian J. Fibre Text. Res. 19, 30.
- Ajgaonkar, S.B., January, 1995. Colourage 35.
- Ali, M., Mian, A.J., Islam, M.N., Rabiul Awual, M., Fazal-E-Karim, S., Sarwaruddin Chowdhury, A.M., 2001. Indian J. Fibre Text. Res. 26, 414.
- Aspinall, G.O., Dasgupta, P.C., 1958. J. Indian Chem. Soc. 724, 3627.
- Atkinson, R.R., 1965. Jute Fibre to Yarn, vol. 27. Chemical Publishing Co, New York, USA.
- A treatise on physical and chemical properties of jute. Int. Jute Council (Int. Jute Org., Dhaka, Bangladesh), IJC (X)/11 20 (24), August 1988, 30.
- Bag, S.C., Banerjee, S.K., Day, A., Sen, S.K., 1984. Cellul. Chem. Technol. 18, 149.
- Bagchi, A., Saha, S.G., Dasgupta, B., Saha, A., Mukherjee, A., 1990. Indian J. Fibre Text. Res. 15, 185–189.
- Bagchi, A., Som, N.C., April 18, 1998. Recent advancement in chemical dehairing, bleaching and dyeing of jute and jute based products. In: Proceedings of 20th Technological Conference of IIRA, Kolkata, p. f1.

- Bagchi, A., Som, N.C., February, 1999. New developments in different chemical finishing of jute based fabrics. In: Proceedings of 21st Technological Conference of IJIRA, Kolkata, p. 76.
- Bandyopadhyay, S.B., 1951. Text. Res. J. 21 (9), 659.
- Banerjee, S.K., Day, A., Bag, S.C., Sengupta, P., Debsarkar NL, N.L., 1985. Colourage 32 (3), 23.
- Banerjee, S.K., Day, A., Ray, P.K., 1986. Text. Res. J. 56, 5.
- Barkar, S.G., 1939a. J. Text. Inst. 30, 273.
- Barkar, S.G., 1939b. Moisture Relationships of Jute. Indian Jute Mills Assocn, Kolkata, India, p. 122.
- Barkar, D.M., Edward, M., Jerman, C.G., 1981. Trop. Sci. 23, 197.
- Basu, G., Chattopadhyay, S.N., 1996. Indian J. Fibre Text. Res. 21, 217.
- Basu, G., De, S.S., Samanta, A.K., 2009. Ind. Crops Prod. 29, 281–288.
- Basu, S., Mitra, B.C., February, 1993. Studies on water repellent and soil resistant jute and jute blended fabrics. In: Proceedings of 16th Technological Conference of IJIRA, Kolkata, p. k1.
- Basu, G., Samanta, A.K., Ghosh, P., 2008. J. Nat. Fibers 5 (1), 19–35.
- Bhattacharjee, H.P., Das, P.C., Roy, A., Som, N.C., 1974. J. Text. Assoc. 35, 23.
- Bhuiyan, A.M., 1986. Recent Achievement of BJRI, in International Jute Organisation (Dhaka) Report on Seminar of Experts/Specialists on Industrial (R&D) and Manufacturing Technology of Jute, Kenaf & Allied Fibres, Held at IJO (Presently IJSG). IJO/V/Industry, Dhaka, 66/5.
- Bose, R.G., Ghose, S.N., Chatterjee, B.K., 1973. Indian Text. J. 83, 153.
- BTRA's Manual on Chemical Processing of Jute and Jute-Based Textiles for Diversified End Uses, 1997. BTRA, Mumbai, pp. 9–14.
- Buschle-Diller, G., Fanter, C., Loth, E., 1999. Text. Res. J. 69 (4), 244.
- Buschle-Diller, G., Zeronian, S.H., Pan, N., Yoon, M.Y., 1994. Text. Res. J. 64 (5), 270.
- Callow, H.J., 1947. Nature 159, 309.
- Callow, H.J., Speakman, J.B., 1949. J. Soc. Dye. Colour. 65, 758.
- Carlene, P.W., 1944. J. Soc. Dye. Colour. 60, 232.
- Chakrabarti, S.K., Ghosh, B.S., Adhikari, D., Kundu, A.B., 1995. Indian J. Fibre Text. Res. 20, 156.
- Chakrabarti, S.K., Ghosh, B.S., Kundu, A.B., Ghosh, B.L., 1991. Indian J. Fibre Text. Res. 16, 154.
- Chakrabarti, S.K., Sinha, S.N., 2001. J. Inst. Eng. (India), Text. Eng. Divn. 82, 1.
- Chakraborty, A.C., 1962. Text. Res. J. 32, 525.
- Chattopadhyay, S.N., Pan, N.C., Day, A., 2002. J. Text. Inst. 93, 306–315.
- Chatterjee, H., 1954. Fibres (Natural and Synthetics), p. 343.
- Chatterjee, H., Pal, K.B., 1955. J. Soc. Dye. Colour. 71, 525.
- Chatterjee, H., Pal, K.B., May, 1952. Textile Manufacturer, p. 25.
- Chatterjee, H., Pal, K.B., Sarkar, P.B., 1954. Text. Res. J. 24, 43.
- Chattopadhyay, S.N., Day, A., Sanyal, S.K., Kundu, A.B., Pan, N.C., Mitra, B.C., 1997a. Indian Text. J. 108 (3), 64.
- Chattopadhyay, S.N., Day, A., Sanyal, S.K., Kundu, A.B., Pan, N.C., Mitra, B.C., 1997b. Indian Text. J. 107 (10), 14.
- Chattopadhyay, S.N., Sanyal, S.K., Day, A., Kundu, A.B., 2000b. J. Text. Assoc. 287. March–April, 2000.
- Chattopadhyay, S.N., Sanyal, S.K., Day, A., Kundu, A.B., 2001. Colourage 48 (7), 20.

- Chattopadhyay, S.N., Sanyal, S.K., Day, A., Kundu, A.B., May 2000a. Man-Made Text India, p. 209.
- Committee on Commodity Problems – Intergovernmental Groups on Fibres, Report on Environmental Impact Assessment of Synthetic Material Competing with Sisal, Henequen, Coir, Abaca, Jute and Kenaf, 1990. Food and Agriculture Organisation of United Nations, Rome.
- Comparative Study of Jute and Polypropylene in Respect of Their Relative Costs and Advantages, February, 2000. Report of Study Conducted by Indian Institute of Technology, New Delhi, vol. 94. Jute Manufacturers Development Council, Kolkata, India, p. 103.
- Cook, G.J., 1993. Handbook of Textile Fibres, Natural Fibres. Mellow Publishing Co.Ltd, p. 16, 5th reprint d edition.
- Daruwalla, E.H., Kangle, P.J., Nabar, G.M., 1961. Text. Res. J. 31, 712.
- Daruwalla, E.H., Subramaniam, M., 1958. J. Soc. Dye. Colour. 74, 296.
- Das, D.B., 1958. Cellulose Res. 5, 47.
- Das, N.N., Das, S.C., Dutt, A.S., Mukherjee, A.K., 1984. Text. Res. J. 54, 166.
- Das, N.N., Das, S.C., Dutt, A.S., Roy, A., 1981. Carbohydr. Res. 94, 73.
- Das, D.B., Mitra, M.K., Wareham, J.F., 1952. J. Text. Inst. 43, 449. T 443, T.
- Davidson, G.F., 1940. J. Text. Inst. 31, 81.
- Davidson, G.F., 1941. J. Text. Inst. 32, 109.
- Dickinson, K., Heathcote, D., 1972. J. Soc. Dye. Colour. 88, 137.
- Dutta, A.K., Ghosh, B.L., 1994. Indian J. Fibre Text. Res. 19, 97.
- Dutta, A.K., Ghosh, B.L., Aditya, R.N., 2000. J. Text. Inst. 91 (1), 28. Part 1.
- Ellis, J., 1995. Scouring, enzymes and softeners. In: Carr, C.M. (Ed.), Chemistry of the Textile Industry. Blackie Academic and Professional, Glasgow, UK, pp. 260–275.
- Farouqui, F.I., Hossain, I., 1990b. Text. Dyer Printer 15. Jan-10.
- Farouqui, F.I., Hossain, I., 1990a. Indian J. Fibre Text. Res. 15, 65–72.
- Farouqui, F.I., Hossain, I., February 21, 1990c. Text. Dyer Printer 23.
- Farouqui, F.I., Hossain, I., January 1990d. Text. Dyer Print. 10, 15.
- FRL process for bleaching jute. US Patent 3 (427), 1968, 609.
- Fross, K., Fremer, K.E., 1983. J. Appl. Polym. Sci. Appl. Polym. Symp. 37, 421.
- Ganguly, P.K., Chanda, S., 1994. Indian J. Fibre Text. Res. 19, 38–41.
- Ganguly, P.K., Mukherjee, A.K., Sur, D., 1995. Indian J. Fibre Text. Res. 20, 86.
- Ganguly, P.K., Samanta, A.K., Nandi, D., Dutta, R.K., Som, N.C., 1987. Colourage 32, 19.
- Ganguly, P.K., Sao, K.P., 1985. Text. Res. J. 55, 376.
- Ganguly, P.K., Sao, K.P., Ambaly, C., 1985. Text. Res. J. 55, 253.
- Govt. Gazette Notification No-SO 243(E) Dt:26th March,1997, Extraordinary Gazette No-193,part-2,sec- 3(ii) & Govt Gazette Notification No-SO 263 dt:30.1.1993. Ministry of Environment & Forests , Govt. of India.
- Ghosh, P., Das, D., 1998. J. Appl. Polym. Sci. 68, 63.
- Ghosh, P., Das, D., 2000. Eur. Polym. J. 36, 2147.
- Ghosh, P., Das, D., 2002. J. Polym. Mater. 19, 209.
- Ghosh, P., Das, D., Samanta, A.K., 1995. J. Polym. Mater. 12, p297.
- Ghosh, B.L., Dutta, A.K., 1980. J. Text. Inst. 71 (2), 108.
- Ghosh, B.L., Dutta, A.K., 1983. J. Text. Inst. 74 (2), 83.
- Ghosh, P., Dutta, C., 1987. Indian J. Technol. 25, 681.
- Ghosh, P., Dutta, C., 1988. Indian J. Technol. 26, 431.
- Ghosh, P., Ganguly, P., 1993. Plast. Rubber Compos. Process. Appl. 20 (3), 171.
- Ghosh, P., Samanta, A.K., 1996. Indian J. Fibre Text. Res. 21, 131.

- Ghosh, P., Samanta, A.K., 1997. *J. Text. Inst.* 88, 209. Part 1, No. 3.
- Ghosh, P., Samanta, A.K., Das, D., 1994. *Indian J. Fibre Text. Res.* 19, 277.
- Ghosh, P., Samanta, A.K., Dev, D., 1997. *J. Appl. Polym. Sci.* 64, 2473.
- Gopal, M., Bhaduri, S.K., Jain, A.K., 1985. *Indian Text. J.* 95, 101.
- Goswami, B.C., Martindale, I.G., Scardino, F.L., *Textile Yarns; Technology, 1977. Structure and Applications*, vol. 17. John Wiley and Sons, New York, USA), p. 26.
- Gravitise, J., Erins, P., 1983. *J. Appl. Polym. Sci. Appl. Polym. Symp.* 37, 421.
- Guha Roy, T.K., Chatterjee, S.K., Adhikari, D., Mukherjee, A.K., 1988. *J. Text. Inst.* 79, 108.
- Guha Roy, T.K., Kulkarni, A.Y., December, 1973. Technical Note No 1. Indian Jute Industries' Research Association, Kolkata, India.
- Guha Roy, T.K., Mukhopadhyay, A.K., Mukherjee, A.K., 1984. *Text. Res. J.* 54, 874.
- Guha, A.K., 1985. *J. Text. Assoc.* 46, 195.
- Gulrajani, M.L., Gupta, D., 1992. *Natural Dye and Their Application to Textiles*, pp. 20–35 (Book Published by Dept of Textile Technology, IIT Delhi).
- Gupta, N.P., Majumdar, A., Mathew, M.D., Sur, D., Roy, D., Dasgupta, P.C., 1985. *Text. Res. J.* 55, 706.
- Gupta, N.P., Mazumdar, A., Bhattacharya, G.K., Sur, D., Roy, D., 1982. *Text. Res. J.* 52, 694.
- Hard, F.S.H., 1955. *J. Text. Inst.* 46, 400.
- Indian Jute, 2005. *Jute Manufacturer Development Council*, vol. 16. Ministry of Textiles, Govt of India, Kolkata, p. 15.
- IJIRA – Monograph (Research Review): *Chemical Processing of Jute Fabrics for Decorative End Use: Part-I – Bleaching Treatment for Jute*, 1977, p. 5.
- Indian Standard: 271-1987, 1987. Bureau of Indian Standard, New Delhi.
- Iyer, K.R., Murthy, D.R., Patil, N.B., Sundaram, V., 1982. *Text. Res. J.* 52, 780.
- Jackson, E.L., Hudson, C.S., 1937. *J. Am. Chem. Soc.* 59, 2049.
- Jackson, E.L., Hudson, C.S., 1938. *J. Am. Chem. Soc.* 60, 989.
- Jute, K., Allied Fibres, FAO Statistics, September, 2003. Food and Agriculture Organisation of the United Nations, Rome.
- Kaswell, E.R., 1953. *Textile Fibres, Yarns and Fabrics*, vol. 11. Reinhold Publishing Corporation, New York, USA, p. 112.
- Klahorst, S., Kumar, A., Mullins, M.M., June 1996. *Colourage*, p. 29.
- Koo, H., Ueda, M., Wakida, T., Yoshimura, Y., Igarashi, T., 1994. *Text. Res. J.* 64 (2), 70.
- Kulkarni, A.Y., Guha Roy, T.K., 1973. *J. Text. Assoc.* 34, 59.
- Kumar, A., Yoon, M.Y., Purtell, C., April, 1997. *Text Chemist Colorist*, p. 37.
- Kundu, B.C., Basak, K.C., Sarcar, P.B., 1959. *Jute in India*, vol. 1. The Indian Central Jute Committee, Kolkata, India, p. 385.
- Kundu, A.B., Ghosh, B.S., Chakrabarti, S.K., 1993. *Text. Res. J.* 63 (8), 451.
- Kundu, A.B., Ghosh, B.S., Chakrabarti, S.K., Ghosh, B.L., 1991. *Text. Res. J.* 61 (12), 720.
- Kundu, A.B., Ghosh, B.S., Dutta, A.K., Ghosh, U.K., Sengupta, S., Ghosh, B.L., 1996. *Indian J. Fibre Text. Res.* 21, 127.
- Kundu, A.B., Ghosh, B.S., Ghosh, B.L., Ghose, S.N., 1962. *Carbohydr. Res.* 105, 288.
- Laga, S.K., Chindwade, S.S., Upadhyay, V.B., January, 1997. *Colourage* 37.
- Lewin, M., 1983. *Chemical processing of fibres and fabrics- fundamental and preparation*. In: Lewin, M., Sello, S.B. (Eds.), *Handbook of Fibre Science and Technology*, vol. 1. Marcel Dekker Inc, New York, USA. Ch 2.
- Lewin, M., Shiloh, M., Banbaji, J., 1959. *Text. Res. J.* 29, 373.
- Lokhande, H.T., Dorugade, V.A., 1998. *Colourage* 21.

- Macmillan, W.G., 1957. *Indian Text. J.* 67, 338.
- Macmillan, W.G., Bhattacharjee, H.P., 1954. *J. Text. Inst.* 45, 700.
- Macmillan, W.G., Sengupta, A.B., Majumdar, S.K., 1949. *J. Indian Chem. Soc.* 12, 105.
- Macmillan, W.G., Sengupta, A.B., Majumdar, S.K., 1950. *J. Indian Chem. Soc.* 13, 115.
- Macmillan, W.G., Sengupta, A.B., Majumdar, S.K., 1954. *J. Text. Inst.* 45, T 703.
- Majumdar, S.K., 1956. *Phil Thesis. Calcutta University*, p. 234.
- Majumdar, S., Dutta, A.K., Dey, S., Ghosh, B.L., 1996. *Indian J. Text. Res.* 21, 265.
- Majumdar, S., Ghosh, B.S., Kundu, A.B., 1987. *Indian J. Text. Res.* 12, 2.
- Majumdar, P., Sanyal, S., Dasgupta, B., Shaw, S.C., Guha Roy, T.K., 1994. *Indian J. Fibre Text. Res.* 19, 286.
- Mallick, P.K., 1988. *Fibre Reinforced Composites: Materials, Manufacturing and Design.* Marcel Dekker Inc, New York, USA.
- Marsh, J.T., 1946. *Mercerizing.* Chapman and Hall Ltd, London, UK, p. 179.
- Mazumdar, A., Samajpati, S., Ganguly, P.K., Sardar, D., Dasgupta, P.C., 1980. *Text. Res. J.* 50, 575.
- Megregor, E.A., Greenwood, C.T., 1982. *Polymers in Nature.* John Wiley, Chichester. Ch 7.
- Meredith, R., 1945. *J. Text. Inst.* 36, 107.
- Mohiuddin, G., January, 1998. *Book of Papers, Int Seminar on Jute and Allied Fibres*, vol. 55. National Institute of Research on Jute and Allied Fibre Technology, Kolkata, India.
- Mondal, S.P., Roy, A., 1981. *Silver Jubilee Monograph, No 12.* Bombay Textile Research Association, Mumbai, India).
- Monograph, 1977. *Chemical Processing of Jute Fabrics for Decorative End-Use, Part I Bleaching Treatment for Jute*, vol. 5. Indian Jute Industries' Research Association, Kolkata, India.
- Moses, J.J., Venkatachalam, A., Ramachandran, C., December 9th–11th, 1999. *Book of Papers of 1st Convention on Natural Dyes.* IIT-Delhi, p. 190.
- Mukherjee, A.C., Mukhopadhyay, A.K., Dutt, A.S., Mukhopadhyay, U., 1981a. *Text. Res. J.* 51, 574.
- Mukherjee, A.C., Mukhopadhyay, A.K., Sardar, B.K., Dutt, A.S., Mukhopadhyay, U., 1981b. *Text. Res. J.* 51, 40.
- Mukhopadhyay, U., 1976. *Text. Res. J.* 46, 153.
- Nevell, T.P., Zeronian, S.H. (Eds.), 1985. *Cellulose Chemistry and its Application.* Ellis Harwood Ltd., Chichester.
- Nodder, C.R., 1942. *Jute Bull* 5, 369.
- Pal, S.K., 1952. *A Practical Treatise on Jute Cultivation and Jute Spinning.* M/S Dasgupta & Co Ltd, Calcutta.
- Pal, P.N., Ghosh, B.L., Macmilan, W.G., 1964. *Indian J. Technol.* 2, 311.
- Pan, N.C., Day, A., Mahalanabis, K.K., 2003. *Cellul. Chem. Technol.* 37 (3–4), 265–271.
- Pandey, S.N., Chattopadhyay, S.N., Basu, G., 1995. *Indian J. Fibre Text. Res.* 20, 102.
- Parsons, H.L., 1939. *J. Text. Inst.* 30, 320.
- Patil P R and Samanta A K, *Man-Made Text. Res. Assoc. Bull.*, March (19) 3.
- Patro, P.S., 1971. *Text. Dyers Printers* 4, 57.
- Preston, J.M., 1933. *Modern Textile Microscopy*, vol. 40. Emmot and Co., Ltd., London, UK).
- Preston, J.M., Nimkar, M.V., 1949. *J. Text. Inst.* 40, 674.
- Pringle, A.V., 1949. *The Theory of Flax Spinning*, vol. 43. H R Carter Publications Ltd., Belfast UK.
- Rahaman, M.M.M., 1978. *J. Text. Inst.* 69, 287.
- Rahman, M.A., Siddiqueullah, M., Mian, J., 1996a. *J. Text. Inst.* 87, 258. Part I (3).

- Rahman, M.A., Siddiqueullah, M., Mian, J., 1996b. *J. Text. Inst.* 87 (3), 600. Part I.
- Rajadhyaksha, P.B., Keskar, V.H., 2002. *J. Text. Assoc.* 63 (4), 195.
- Ranjan, T.C., *Handbook on Jute*, vol. 1–3 (Oxford and IBH Publishing Co, Kolkata, India).
- Ridge, B.P., Little, A.H., 1942. *J. Text. Inst.* 33. T36 and T59.
- Ridge, B.P., Little, A.H., Wharton, J., 1944. *J. Text. Inst.* 35, 93.
- Roy, M.M., 1953. *J. Text. Inst.* 44, T44.
- Roy, P.K., 1967. *Text. Res. J.* 37, 434.
- Roy, A., 1968. *Jute Chronicle* 3, 134.
- Roy, P.K., 1976. *J. Appl. Polym. Sci.* 20, 1765.
- Roy, A., Chatterjee, S.K., Ganguli, A.K., October/December, 1974. *J. Text. Assoc.* 156.
- Roy, P.K., Das, B.K., Banerjee, S.K., Sen, S.K., 1983. *J. Appl. Polym. Sci.* 21, 263.
- Roy, P.K., Das, B.K., Sen, S.K., Dasgupta, P.C., 1976. *Indian J. Text. Res.* 1, 88.
- Roy, S., Lutfar, L.B., 2012. Chapter-3 on bast fibres: jute. In: Kozolowsky, R. (Ed.), *Hand Book on Natural Fibres: Types, Properties and Factors Affecting Breeding and Cultivation*, first ed. vol. 1, pp. 24–45. Woodhead Publishing Series in Textiles.
- Saha, P.K., Chatterjee, K.K., Sarkar, P.B., 1961. *Woolenized Jute as Wool Substitute Indian Central Jute Committee. Technological research Laboratory, Kolkata, India.*
- Samajpati, S., Majumdar, A., Dasgupta, P.C., 1979. *Text. Res. J.* 49, 8.
- Samanta AK, A.K., Mahalanabis, K.K., Singhee, D., August, 2004. *J. Inst. Eng., Text. Eng.* 85, 1–17.
- Samanta, A.K., 2014. *Stand. India J. BIS, India* 28, 22–40. ISSN 0970-2628.
- Samanta, A.K., Agarwal, P., 2009a. *Indian J. Fibre Text. Res.* 34, 384–399.
- Samanta, A.K., Agarwal, P., 2009b. *J. Polym. Mater.* 26 (3), 293–313.
- Samanta, A.K., Agarwal, P., 2009c. *J. Polym. Mater.* 26 (3), 315–329.
- Samanta, A.K., Agarwal, P., Datta, S., 2006. *J. Inst. Eng. (I) Text. Eng.* 87, 16–26.
- Samanta, A.K., Agarwal, P., Datta, S., 2007. *Indian J. Fibre Text. Res.* 32, 466–476.
- Samanta, A.K., Agarwal, P., Datta, S., 2008c. *Indian J. Fibre Text. Res.* 32, 66–72.
- Samanta, A.K., Agarwal, P., Datta, S., 2008d. *Indian J. Fibre Text. Res.* 33, 171–180.
- Samanta, A.K., Agarwal, P., March, 2008. *Int. Dyers* 37–42.
- Samanta, A.K., Bagchi, A., 2012. Eco-friendly rot and crease resistance finishing of jute fabric using citric acid and poly ethylene glycol. *J. Polym. Mater.* 29 (3), 349–359.
- Samanta, A.K., Bagchi, A., 2013. *J. Inst. Eng. (India)-Ser-E* 94 (1), 7–13.
- Samanta, A.K., Bagchi, A., 2017. *J. Inst. Eng. (India) –Ser-E* 98 (1), 25–31.
- Samanta, A.K., Bagchi, A., Biswas, S.K., 2011. *J. Polym. Mater.* 28 (2), 149–169.
- Samanta, A.K., Basu, G., Ghosh, P., 2004. *Indian J. Fibre Text. Res.* 29, 85–99.
- Samanta, A.K., Basu, G., Ghosh, P., 2007. *J. Nat. Fibers* 4 (4), 59–72.
- Samanta, A.K., Basu, G., Ghosh, P., 2008a. *J. Text. Inst.* 99 (4), 295–306.
- Samanta, A.K., Basu, G., Ghosh, P., 2008b. *J. Text. Inst.* 99 (4), 307–316.
- Samanta, A.K., Bhattacharya, K., 2015a. *AASCIT- J. Mater. Sci. Appl.* 1 (4), 174–184.
- Samanta, A.K., Bhattacharya, K., 2015b. *TLIST J.* 4, 1–16.
- Samanta, A.K., Bhattacharya, K., Hossain, A., 2016. *AASCIT- J. Mater. Sci. Appl.* 2 (4), 25–34.
- Samanta, A.K., Bhattacharyay, R., Chowdhury, R., 2015. *ASSICT J. Mater.* 1 (4), 98–110.
- Samanta, A.K., Bhattacharyya, R., Jose, S., Basu, G., Chowdhury, R., 2017c. *Cellulose* 24 (2), 1143–1157.
- Samanta, A.K., Das, J., 1992. *Inst. Eng. (India), Text. Eng.* 73, 52.
- Samanta, A.K., Das, D., Sett, S.K., 1995. *J. Inst. Eng. Text. Engg. Div.* 76, 12.

- Samanta, A.K., February, 1995. *Colourage*, (XLII), p. 37.
- Samanta, A.K., Ghosh, P., 1996. *Indian J. Fiber Text. Res.* 21, 131.
- Samanta, A.K., Konar, A., Agarwal, P., Datta, S., 2010. *J. Polym. Mater.* 27 (3), 203–236.
- Samanta, A.K., Konar, A., Bhoumick, N.S., Ray, A.N., 2017a. *J. Inst. Eng. (India) –Ser-E* 98 (2), 121–133.
- Samanta, A.K., Konar, A., Ray, A.N., Bhaumik, N.S., 2017b. *Indian J. Nat. Fibres* 4 (1), 59–76.
- Samanta, A.K., Konar, A., Tapas Ranajan Kar & Sarmishtha Chakraborty International, 2014. *Review of applied engineering research*, 4 (1), 51–67. ISSN 2248-9967.
- Samanta, A.K., Ray, D., February, 2000. *Text. Trends* 38.
- Samanta, A.K., Singhee, D., Agarwal, P., Datta, S., 2009. *J. Text. Inst.* 100, 565–587.
- Samanta, A.K., Singhee, D., Basu, G., Mahalanabis, K.K., 2005. *Indian J. Fibre Text. Res.* 30, 451–467.
- Samanta, A.K., Singhee, D., Mahalanabis, K.K., 2007. *Indian J. Fibre Text. Res.* 32, 221–231.
- Samanta, A.K., Singhee, D., Mahalanabis, K.K., 2008e. *J. Inst. Eng. India* 88, 17–26.
- Samanta, A.K., Singhee, D., Sengupta, A., Rahim, S.K., February, 2003b. *J. Inst. Eng. (I) Text. Eng.* 83, 22–33.
- Sao, K.P., Jain, A.K., 1984. *J. Text. Assoc.* 45, 155.
- Sarkar, P.B., 1931. *J. Indian Chem. Soc.* 8, 397.
- Sarkar, P.B., 1934. *J. Indian Chem. Soc.* 11, 407, 5, 8.
- Sarkar, P.B., 1935. *J. Indian Chem. Soc.* 12 (23), 470, 542, 547.
- Sarkar, P.B., 1937. *Sci Cult. (India)* 3, 551, 411, 485.
- Sarkar, P.B., Chatterjee, H., 1948a. *J. Soc. Dye. Colour.* 64, 218.
- Sarkar, P.B., Chatterjee, H., 1948b. *J. Text. Inst.* 39, 274.
- Sarkar, P.B., Chatterjee, H., Mazumdar, A.K., 1947. *J. Text. Inst.* 38, 318.
- Sarkar, P.B., Chatterjee, H., Mazumdar, A.K., Pal, K.P., 1948. *J. Text. Inst.* 39, TI.
- Sarkar, P.B., Mazumdar, A.K., 1955. *Text. Res. J.* 25, 1016.
- Sarkar, P.B., Mazumdar, A.K., Pal, K.B., 1948. *J. Text. Inst.* 39, T44.
- Sen, S.K., Dasgupta, P.C., 1974. *J. Text. Assoc.* 35, 85.
- Sengupta, S.R., 1961. *Jute Gunny Rev.* 12, 169.
- Sengupta, A.B., Dutt, A.S., 1958. *Cellulose Research – a Symposium. Council of Scientific and Industrial Research, India*, p. 112.
- Sengupta, A.B., Majumdar, S.K., 1967. *IJIRA process of bleaching jute. Indian Patent* 110, 628. *British Patent* 1, 221, 527 (1968); *US Patent* 3, 521, 991 1969.
- Sengupta, A.B., Majumdar, S.K., Macmillan, W.G., 1958. *Indian J. Appl. Chem.* 21, 105.
- Sengupta, A.B., Majumdar, S.K., Macmillan, W.G., 1960. *Sci. Cult.* 25, 443.
- Sengupta, A.B., Radhakrishnan, T., 1972a. *New Ways to Produce Textiles. The Textile Institute, Manchester, UK*, p. 112.
- Sengupta, A.B., Radhakrishnan, T., 1972b. *The Diversification of Jute: Decorative Fabrics. Textile Inst, Bulletin , Manchester*, p. 114.
- Shade Card on Jute for Value Added Products, August, 1990. *IJIRA, Kolkata*.
- Sharma, U., 1986. *Colourage* 33, 17.
- Sharma, M., January, 1993. *Colourage* 40, 13.
- Shukla, S.R., Sharma, U., Kulkarni, K.S., February, 2000. *Colourage* 19.
- Sikdar, B., Adhikari, D., Das, N.N., 1973. *Indian J. Text. Res.* 11, 153.
- Sikdar, B., Mukhopadhyay, A.K., Mitra, B.C., 1993. *Indian J. Fibre Text. Res.* 18, 139.
- Sinha, A.K., Gupta, N.P., 1986. *Indian J. Text. Res.* 11, 35.
- Sinha, A.K., Mathew, M.D., Roy, D., 1988. *Indian J. Fibre Text. Res.* 13, 26.

- Sinha, D.K., Raymallick, S., 2002. Text. Trends 45 (7), 25.
- Sinha, M.K., Sanyal, A.K., Day, A., Ghosh, S.K., 1977. Annual Report, vol. 15. Jute Technological Research Laboratory, Calcutta, India.
- Smith, H.D., 1944. Textile fibres: an engineering approach to their properties and utilisation. ASTM Proc. 19th Edgar Marburg Lect. 44, 543.
- Som, N.C., Bagchi, A., Mukherjee, A.K., 1987a. Indian J. Text. Res. 12, 78 (Part I) and 126 (Part II).
- Som, N.C., Bagchi, A., Mukherjee, A.K., 1987b. Indian J. Technol. 25, 674.
- Stout, H.P., 1985. In: Lewin, M., Pearce, E.M. (Eds.), Handbook of Fibre Science and Technology, vol. IV. Marcel Dekker Inc, New York, USA, p. 701.
- Sur, D., Bhattacharyya, S.K., Basu, M.K., July 1983. J. Text. Assoc. 128.
- Tendulkar, S.R., Mandavawalla, A.K., 1991. Text. Dyer Print. 24 (2), 27.
- Textile Terms and Definitions, 1995. The Textile Institute, Manchester, UK, p. 340.
- Warwicker, J.O., Jeffries, R., Colbran, R.I., Robinson, P.N., 1966. A Review of Literature on the Effect of Caustic Soda and Other Swelling Agents on Fine Structure of Cotton. Shirley Institute, Manchester, UK. Pamphlet No 3.
- Wilson, M., 1962. Bull British Jute Trade Res Assoc, 9 Bull (Part A & B), vol. 56, pp. 14–26.
- Zahn, H., Das, P.C., 1965. Text. Ind. 67, 353.

Further reading

- Impact of synthetics on jute and allied fibres. Commodity Bull. Ser. (Food and Agric. Org. United Nations, Rome) vol. 89, 1969, 91.
- IJSG Publication –Jute Basics, first ed., 2010
- Abdul Jabbar, 2017. Sustainable Jute-Based Composite Materials: Mechanical and Thermo-mechanical Behaviour. Springer Publication.
- Atkinson, R.R., 1965. Jute-Fibre to Yarn. Chemical Pub. Co., New York. ISBN-13: 978-0820600949.
- Carter, H.R., August, 2016. Modern flax, hemp and jute spinning and twisting; a practical handbook for the use of flax, hemp, and jute spinners, thread, twine, and rope makers, 28.
- Chavan, R.B., 1999. Chemical Processing of Handloom Yarns and Fabric, vol. 7. Dept. of Textiles Technology, (I.I.T.Delhi).
- Dedhia, E.M., 1998. Natural dyes. Colourage 16 (3), 45.
- Ghosh, S.K., April 1, 2016. A Technical Handbook on Bituminized Jute Paving Fabric (BJPF): A Partial Substitute and Reinforcement of Bitumen Mastic, first ed. Woodhead Publishing India in Textiles. ISBN 9789385059193 - CAT# N11809.
- Kirby, R.H., 1963. Vegetable Fibres.
- Kozlowski, R., Baraniecki, P., Barriga-Bedoya, J., 2005. Chapter -2: Bast Fibres (flax, hemp, jute, ramie, kenaf, abaca). In: Biodegradable and Sustainable Fibres. Woodhead publishing in Textiles, pp. 36–110. ISBN 13:978-1-85573-916-1 (Book).
- Krishnan, K.B., Doraiswami, I., Chellamani, K.P., 2005. Chapter -2: “Jute”: in Book on Bast and Other Plant fibres. In: Franck, R.R. (Ed.). Woodhaed Publishing in Textiles Series, pp. 24–93. ISBN - 978-1-85573-684-9.
- Kundu, B.D., 1959. Jute in India. Indian Central Jute Committee, Calcutta.
- Neogi, S.K., Jute, W., Neogi, D., 2009. Kolkata.

- Rahaman, M.D.S., 2010. In: Müssig, J. (Ed.), *Jute –A Versatile Natural Fibres, Cultivation, Extraction and Processing in Book on Industrial Applications of Natural Fibres: Structure, Properties and Technical applications*. John Wiley & Sons (Wiley series in renewable resources), pp. p135–162.
- Roy, S., Lutfar, L.B., 2012. Chapter -3 Bast fibres: Jute. In: Kozlowski, R. (Ed.), *Handbook on Natural Fibres: Types, Properties and Factors Affecting Breeding and Cultivation*, first ed.vol-1. Woodhead Publishing Series in Textiles, pp. p. 24–45.
- Samanta, A.K., Singhee, D., Sethia, M., 2003a. *Colourage* 50 (10), 29.
- Stout, H.P., 1988. *Fibre and ran Quality in Jute Spinning*. The Textile Institute, Manchester.
- Stout, H.P., *Fibre and Yarn Quality in Jute Spinning; an Account of Fibres on Machinery Research Work; Manual of Textile Technology*, Ed by P W Harrisor (The Textile Institute, Manchester), vol. 2, 20.
- Sur, D., 2005. *Understanding Jute Yarn*. Institute of Jute Technology, Anindita Sur, Kolkata, p. 254.
- Woodhouse, T., Kilgour, P., November 4, 2014. *The Jute Industry: From Seed to Finished Cloth*. Macmillan and Co. Ltd, London. Original 1st Ed March -1921, Reprinted in paperback.

Silk – production and future trends

3

K. Murugesh Babu

Department of Textile Technology, Bapuji Institute of Engineering and Technology, Davangere, Karnataka, India

3.1 Introduction to silk and silk industry

Silks belong to a group of high molecular weight organic polymers characterized by repetitive hydrophobic and hydrophilic peptide sequences (Altman et al., 2003). Silks are fibrous protein polymers that are spun into fibres by some arthropods such as silkworms, spiders, scorpions, mites and fleas (Altman et al., 2003; Craig, 1997). There are thousands of silk-spinning insects and spiders, yet only a few have been investigated in detail. Silks differ in composition, structure and properties depending on their specific source and function (Altman et al., 2003; Craig et al., 1999; Sheu et al., 2004). They are naturally produced by spiders or insects, such as *Nephila clavipes* and *Bombyx mori*, respectively (Becker et al., 2003; Bell et al., 2002). Silkworm fibres are classified as domestic silk and wild silk. Wild silks are produced by caterpillars other than the mulberry silkworm and they differ from the domesticated varieties in colour, size and texture. The cocoons gathered in the wild usually have been damaged by the emerging moth before the cocoons are gathered, so the silk thread that makes up the cocoon has been torn into shorter lengths. Domestic silkworm like '*Bombyx mori*' are commercially reared and the pupae are killed by dipping them in boiling water before the adult moths emerge allowing the whole cocoon to be unravelled as one continuous thread. There are other commercially exploited silk worms other than '*Bombyx mori*' which can be used to rear the silk which are known as non-mulberry silkworms like *Antheraea mylitta* (tasar), *Phylisamia ricini* (eri) and *Antheraea assama* (muga). Silks are also produced by spiders and insects which secrete glycine-rich silks characterized by their unique synthesis and processing features, as well as strength and extensibility.

The silk filament contains 72%–81% fibroin, 19%–28% sericin, 0.8%–1.0% fat and wax and 1.0%–1.4% colouring matter and ash of the total weight. The silkworm extrudes the liquid fibre from the two excretory canals of sericteries which unite in the spinneret in its head, each of them termed as brin. The two brins cemented together in the spinneret by sericin become a single continuous fibre called the bave or filament. The seric bave is thus made by the union of two brins held together by sericin (Paolo Carboni, 1952). Fibroin is a valuable protein along with sericin, sericin acts as a glue to fix fibroin fibre together in a cocoon. Sericin and fibroin protein is useful because of its properties and has been found to possess various biological functions.

Molecular weight of the sericin ranges from 10 to 310kDa and fibroin ranges from 300 to 450kDa (Tanaka et al., 1999; Zhou et al., 2000), but silk produced by spiders is mechanically superior to any insect silk. However, spider silk differ in many aspects from those produced by mulberry silkworms. The fibroin is a protein dominated in composition by the amino acids glycine, alanine and serine, which form antiparallel β sheets in the spun fibres (Asakura and Kaplan, 1994; He et al., 1999; Asakura et al., 2002). But only the silk of moth caterpillars has been used widely for textile manufacture and other applications. The main differences between spider and mulberry silkworm silks is that dragline spider silks are mechanically superior, but the better water resistance and availability characters makes the silkworm silks more prominent. The choice of silk for a particular application must therefore include careful consideration of the desired properties.

Genetically, silks are characterized by a combination of highly repetitive primary sequences that lead to significance in secondary structure, which provides unique mechanical properties. Because of these impressive properties, combined with their biocompatibility and relative environmental stability, silks have been used as an important set of material options in the fields of controlled release, biomaterials, in addition to their uses as textile materials (Juming Yao and Tetsuo Asakura, 2004).

The structure of silk is shown in Fig. 3.1. Silk of *Bombyx mori* is composed of the proteins fibroin and sericin, matters such as fats, wax, sand pigments and minerals.

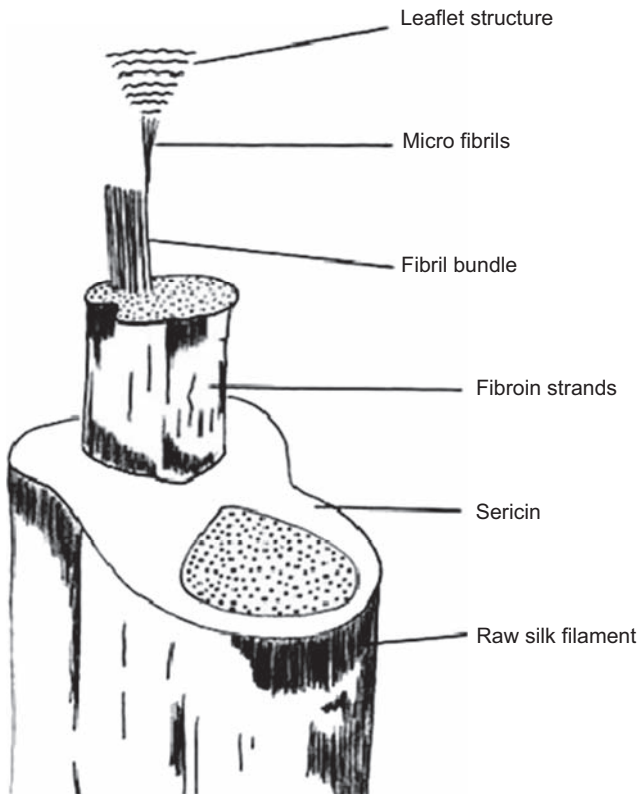

Figure 3.1 Structure of silk.

Table 3.1 Amino acid composition of Fibroin and Sericin.

Amino acids	Fibroin	Sericin	Amino acids	Fibroin	Sericin
Glycine	42.8	8.8	Glutamic acid	1.7	10.1
Alanine	32.4	4.0	Serine	14.7	30.1
Leucine	0.7	0.9	Threonine	1.2	8.5
Isoleucine	0.9	0.6	Phenylalanine	1.2	0.6
Valine	3.0	3.1	Tyrosine	11.8	4.9
Arginine	0.9	4.2	Proline	0.6	0.5
Histidine	0.3	1.4	Methionine	0.2	0.1
Lysine	0.5	5.5	Tryptophan	0.5	0.5
Aspartic acid	1.9	16.8	Cystine	0.1	0.3

Values are given as gram of amino acid per 100 g of protein (Tanaka K et al., 1999).

Fibroin in the *Bombyx mori* comprises a high content of the amino acids glycine and alanine, 42.8 and 32.4g, respectively as shown in Table 3.1. The key amino acids in sericin are serine (30.1g), threonine (8.5g), aspartic acid (16.8g) and glutamic acid (10.1g).

Table 3.1 shows that there are different proportions of amino acid residues in fibroin. Fibroin has high proportion of alanine, glycine, and serine. A small amount of cystine residues give a very small amount of sulphur in the fibre. Fibroin contains only a small amount of amino acid side chains. The amounts of acid and alkali that can be absorbed by silk are relatively lower than those absorbed by wool (ca 0.2 equivalents per kg of silk). The isoelectric point of silk fibre is around pH 5. There is a low proportion of amino acid residue with large side chain. In silk hydrogen bonding is important in fibroin. X-ray structure analysis of the crystalline domain of fibroin shows that the peptide chains pack in fully extended forms (Apichart Sonthisombat and Peter, 2004) (Fig. 3.2).

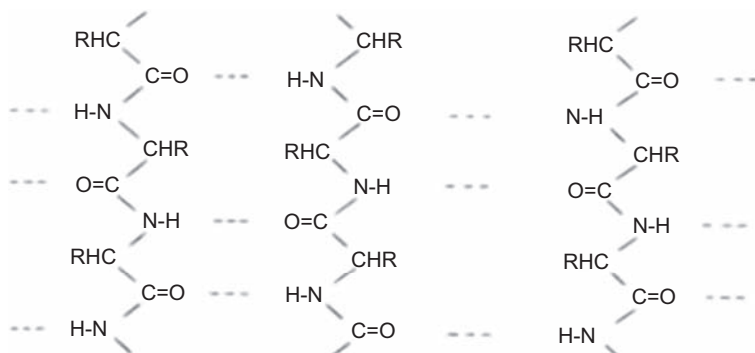
**Figure 3.2** Crystal structure of the poly peptide bond in the silk fibroin (Guljarni, 1992).

3.2 Types of silk and their importance

Silk is mainly divided into two types they are

- Mulberry silk (*Bombyx mori*) also called cultivated silk and
- Non-mulberry silk.

3.2.1 Mulberry

Mulberry silk is also known as cultivated silk and *Bombyx* silk, but mulberry silk is the most commonly used term. It is also sometimes referred to it by its type which is thrown or reeled silk (Mahadevappa et al., 2001). Fig. 3.3 shows the mulberry worm and the cocoons.

The bulk of the commercial silk produced in the world comes from mulberry silk. Mulberry silk comes from the silkworm, *Bombyx mori* which solely feeds on the leaves of mulberry plant. These silkworms are completely domesticated and reared indoors. In India, the major mulberry silk producing states are Karnataka, Andhra Pradesh, West Bengal, Tamil Nadu and Jammu Kashmir which together accounts for 92% of country's total mulberry raw silk production (Mahadevappa et al., 2001). World raw silk production is shown in Table 3.2.

3.2.1.1 Types of mulberry silk

Bombyx mori, the domesticated silk worm, has been reared for over 2000 years. During this long history many mutations have occurred. The mutants have been further classified with each other resulting in a combination of various genes producing a large number of silk worm races. The silk worm races are classified on the basis of their

1. Place of origin
2. Voltinism and
3. Moulting



Figure 3.3 Mulberry silk worm and cocoons.

Table 3.2 Global raw silk production (in metric Tonnes).

#	Countries	2013	2014	2015	2016	2017
1	Bangladesh	43	44.5	44	44	41
2	Brazil	550	560	600	650	600
3	Bulgaria	8.5	8	8	9	10
4	China	1,30,000	1,46,000	1,70,000	1,58,400	1,42,000
5	Colombia	0.6	0.5	0.5	-	-
6	Egypt	0.7	0.8	0.8	1.2	1.1
7	India	26,480	28,708	28,523	30,348	31,906
8	Indonesia	16	10	8	4	2.5
9	Iran	123	110	120	125	120
10	Japan	30	30	30	32	20
11	North Korea	300	320	350	365	365
12	South Korea	1.6	1.2	1	1	1
13	Philippines	1	1.1	1.2	1.82	1.5
14	Syria	0.7	0.5	0.3	0.25	0.25
15	Thailand	680	692	698	712	680
16	Tunisia	4	4	3	2	2
17	Turkey	25	32	30	32	30
18	Uzbekistan	980	1100	1200	1256	1200
19	Vietnam	475	420	450	523	520
20	Madagascar	18	15	5	6	7
	Total	159,737.10	178,057.62	202,072.83	192,512.27	177,507.35

3.2.2 Place of origin

3.2.2.1 Indian races

These races are aboriginal in India and south East Asia. The larval stage is longer and they are robust against high temperature and humidity. The size of the cocoon and larvae is small. In many cases, the cocoon is spindle shaped and the cocoon colour is green, yellow or white. The cocoon shell is thin with less shell percentage. They are mainly multivoltine.

3.2.2.2 Japanese races

These races are aboriginal in Japan. The larvae are robust. The cocoon is in peanut shape. The sizes of the larvae do not correspond with the long larval duration. The

cocoon colour is usually white but few are also green or yellow in colour. The ratio of double cocoons is more. The quality of the silk filament is inferior and it is thick and short. They are univoltine or bivoltine.

3.2.2.3 Chinese races

These races are aboriginal in China. The larvae are robust against high temperature but weak against high humidity. The larvae are plain and active. They voraciously eat mulberry leaves and grow quickly. The cocoon shape is, in many cases, elliptical spherical and spindle shaped in few cases. The cocoon colour is white, golden yellow, green, red or beige. The cocoon filament is fine and reelability is good. They are univoltine, bivoltine and multivoltine.

3.2.2.4 European races

These races are aboriginal in Europe and Central Asia. Larval duration is long and they actively eat mulberry leaves. Larvae are weak against high temperature and high humidity. The cocoon size is big with a little constriction. The cocoon reelability is good.

3.2.3 Voltinism

According to voltinism, silkworms are classified into (a) Univoltines, (b) Bivoltines and (c) Multi- or polyvoltines.

3.2.3.1 Univoltines

These races have only one generation in a year. The larvae body size is large. The cocoon weight, shell weight, shell ratio and cocoon filament weight are high. The cocoon filament quality is good.

3.2.3.2 Bivoltines

These races have two generations in a year; the silk worms are more uniform and strong. The cocoon weight, cocoon shell weight, shell ratio and cocoon filament weight are less compared to univoltines. Larvae are robust compared to univoltines.

3.2.3.3 Multivoltines

The life cycle is short. They have many generations in a year. Larvae are robust and can withstand high temperature. The cocoons size is small. The cocoon weight, shell ratio and cocoon filament weight are less than bivoltines. Cocoon filament is fine.

3.2.3.4 Moulting

Based on moulting, silkworms are classified into (a) trimoulters, (b) tetra-moulters, (c) pentamoulters, rarely bimoulters and hexamoulters. Tetramoulters are mainly reared for commercial purposes.

Thai silk is only one of the mulberry silk worm (*Bombyx mori*) silks but it differs somewhat in appearance, and is yellower in colour. The filament is coarser and has more silk gum (e.g. up to 37%) than normal mulberry silk (e.g. 20%–25%) (Zhou et al., 2000; Dhavalikar, 1962). These characteristics cause Thai silk to have its own style after weaving. Thai silk products are mainly produced by domestic industries in the northern and north east part of Thailand.

3.2.4 Non-mulberry

A large number of species (400–500) are used in the production of non-mulberry silks, but only about 80 have been commercially exploited in Asia and Africa, chiefly in tribal communities. The major varieties of non-mulberry silk are described below (Jolly et al., 1979).

3.2.4.1 Tasar

Tasar silk popularly known as ‘Dasali Pattu’ is a wild silk reeled from Tasar cocoons. Tasar (Tussah) is copperish colour, coarse silk mainly used for furnishings and interiors. It is less lustrous than mulberry silk, but has its own feel and appeal. Tasar silk is generated by the silkworm, *Antheraea mylitta* which mainly thrive on the food plants asna (*Terminalia tomentosa*) and arjun (*Terminalia arjuna*). The rearing is conducted in nature on the trees in the open areas. In India, tasar silk is mainly produced in the states of Bihar, Jharkhand, Chhattisgarh and Orissa, besides Maharashtra, West Bengal and Andhra Pradesh. Tasar culture is the main stay for many a tribal community in India (Jolly et al., 1979). Fig. 3.4 shows the tasar worm and the cocoons.

3.2.4.2 Oak tasar

It is a finer variety of tasar generated by the silkworm, *Antheraea proylei* J, in India which feeds on natural food plants of oak, found in abundance in the sub-Himalayan belt of India, covering the states of Manipur, Himachal Pradesh, Uttar Pradesh, Assam, Meghalaya, and Jammu and Kashmir. China is the major producer of oak tasar in the world and this comes from another silkworm which is known as *Antheraea pernyi*.

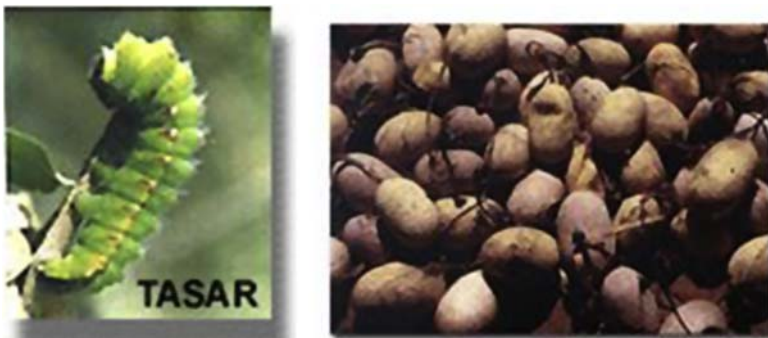

Figure 3.4 Tasar silk worm and cocoons.

3.2.4.3 Eri

Eri silk is known as ‘Ahimsa Silk’. Also known as Endi or Errandi, Eri is a multivoltine silk spun from open-ended cocoons, unlike other varieties of silk. Eri silk is the product of the domesticated silkworm, *Philosamia ricini* which, mainly thrive on food plants Castor and Tapioca, Kessera, Papaya etc. Eri cocoon is open-mouthed; the filament is discontinuous and thus can be used only for spinning. Like tasar, the cocoon varies in colour, size and softness. The soft cocoons are better for mechanical spinning and slightly hard and bigger cocoons for hand spinning (Sonwalker, 1969). The picture of the worm and the cocoons is presented in Fig. 3.5.

Eri silk is having the unique dual characteristics of the softness of silk as the warmth of the wool and holds a lot of promise as commercial venture. Ericulture is a household activity practiced mainly for protein rich pupae, a delicacy for the tribal. Resultantly, the eri cocoons are open-mouthed and are spun. The silk is used indigenously for preparation of chaddars (wraps) for own use by these tribals. In India, this culture is practiced mainly in the north-eastern states and Assam. It is also found in Bihar, West Bengal and Orissa (Dhavalikar, 1962).

The Eri silk production in India is 1483 MTs (metric tons) per annum mainly with 90% from Northeast states. It provides gainful employment to the people with emphasis on women folk in rural areas where poverty and unemployment is concentrated.

3.2.4.4 Muga

This golden yellow coloured silk is prerogative of India and the pride of Assam state. It is obtained from semi-domesticated multivoltine silkworm, *Antheraea assamensis*. These silkworms feed on the aromatic leaves of Som and Soalu plants and are reared on trees similar to that of tasar. Muga culture is specific to the state of Assam and an integral tradition and culture of that state. The Muga silk and high value product is used in products like sarees, mekhalas, chaddars, etc. Fig. 3.6 shows the Muga silk worm and the cocoons.



Figure 3.5 Eri silk worm and cocoons.

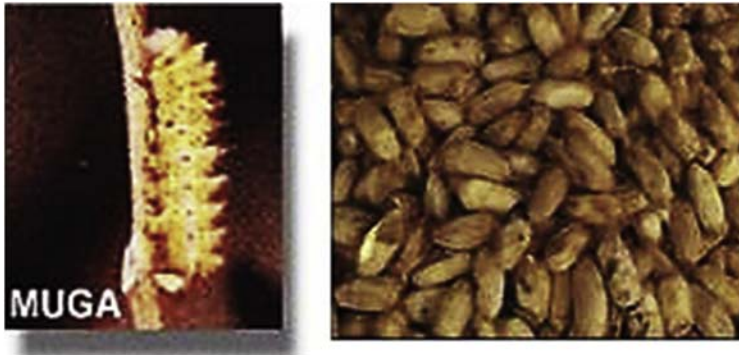

Figure 3.6 Muga silk worm and cocoons.

3.2.4.5 *Anaphe silk*

This silk of southern and central Africa is produced by silkworms of the genus *Anaphe*: *A. moloneyi druce*, *A. Panda Boisduval*, *A. reticulate walker*, *A. carteri walsingham*, *A. venta butler* and *A. infracta walsingham*. They spin cocoons in communities, all enclosed by a thin layer of silk. The tribal people collect them from the forest and spin the fluff into a raw silk that is soft and fairly lustrous. The silk obtained from *A. infracta* is known locally as ‘book’, and those from *A. moloneyi* as ‘tissniantsamia’ and ‘koko’. The fabric is elastic and stronger than that of mulberry silk. *Anaphe* silk is used in velvet and plush.

3.2.4.6 *Fagara silk*

Fagar is obtained from the giant silk moth *Attacus atlas L* and a few other related species or races inhabiting the Indo-Australian biographic region, China and the Sudan. They spin light-brown cocoons nearly 6 cm long with peduncles of varying lengths (2–10 cm).

3.2.4.7 *Coan silk*

The larvae of *Pachypasa otus D*, from the Mediterranean biographic region (southern Italy, Greece, Romania, Turkey, etc.), feed primarily on trees such as pine, ash, cypress, juniper and oak. They spin white cocoons measuring about 8.9×7.6 cm. In ancient times this silk was used to make the crimson-dyed apparel worn by the dignitaries of Rome; however, commercial production came to an end long ago because of the limited output and the emergence of superior varieties of silk.

3.2.4.8 *Mussel silk*

Where the non-mulberry silks previously described are of insect origin, mussel silk is obtained from a bivalve, *Pinna squamosa*, found in the shallow waters along the Italian and Dalmatian shores of the Adriatic. The strong brown filament or byssus is combed and then spun into a silk popularly known as ‘fish wool’. Its production is largely confined to Taranto, Italy.

3.2.4.9 Spider silk

Spider silk is another non-insect variety. It is soft and fine, but also strong and elastic. The commercial production of this silk comes from certain madagascan species, including *Nephila madagascariensis*, *Miranda aurentia* and *Eperia*. As the spinning tubes (spinnerules) are in the fourth and fifth abdominal part to a frame, from which the accumulated fibre is reeled out four or five times a month.

Because of the high cost of production, spider silk is not used in the textile industry; however, durability, resistance to extremes of temperature and humidity make it indispensable for cross hairs in optical instruments (Jolly et al., 1979).

3.3 Silk industry

There are many steps involved in silk manufacturing

- Cultivation of Cocoons (Sericulture)
- Reeling Operations.
- Production of Silk Yarns and fabrics.

3.3.1 Sericulture

Sericulture is the cultivation of cocoons for their filaments. The best raw silk is obtained from the species of moth called *Bombyx mori*. Breeding of silkworm occurs once in a year but under scientific conditions, they may be hatched three times a year. The female moth lays around 350 to 400 eggs and the moths die soon after. As they are subject to hereditary infection, the eggs from infected moths are destroyed which results into production of fine silk. Larvae of about 3 mm are hatched from the eggs. For about 20–30 days, they are carefully nurtured and are fed five times a day on chopped mulberry leaves. In the meantime, the larvae change their skin for four times and are formed into caterpillar of about 9 cm long. Now they are ready to spin cocoon for which racks, clusters of twigs or straw are provided.

3.3.1.1 Artificial feeding of silkworm larvae

One of the alternatives for improving larval feeding is enrichment of mulberry leaves with different supplementary nutrients such as vitamins. Although the Mulberry (*Morus* sp.) leaf is considered as the traditional food for silkworm, but now a day's many attempts has been made to establish artificial diet. The practical application of artificial diets in sericulture which has enabled to save an enormous deal of labour for the rearing and the rearing young healthy larvae has rapidly expanded. It has been reported that after continued research, the substances involved in three step feeding behaviour of *Bombyx mori* silkworm which are found in mulberry leaves as attracting factor (Citral), biting factor (β -sitosterol, morin or isoquercitrin) and swallowing factor (cellulose powder) and supplementary factors (potassium diphosphate,

sucrose, inositol and silicasol) in agar-agar jelly pure form were prepared (Hamamura, 1959). In addition to the fresh leaf alcohol, the fresh leaf aldehyde also attracted *Bombyx mori* silkworm (Wannabe, 1958).

Yamada and Kato (1966) worked on chlorogenic acid, found in water soluble part of mulberry leaves and Hamamura et al. (1966) worked on the role of polyphenolic acid in growth of silkworm. According to Arai and Ito², amino acid present in the mulberry leaves protein was analyzed and mixture of the same was included in the artificial diet in place of soybean powder.

Recently, two kinds of artificial diets have been used to simplify the process for the manufacturing of the prepared diets from the dried diets. One is the 'Pellet diet', is produced by using a twin-spindle extruder and can be fed to the silkworms by soaking with a suitable amount of water just before use. Another one is namely 'Yuneri diet' can be fed to the silkworms by mixing with hot water at around 80°C without steaming (Hiroshi and Hiro-aki, 1994).

The caterpillar have small openings under their jaws called spinnerets through which they secrete a protein like substance. This substance solidifies when it comes in contact with air and the filament thus formed is spun around the silkworm in the figure resembling the digit 8. In 3 days the cocoon gets completed which is about a peanut shell's size. The filament is held together by sericin or silk gum. The life of the worm is ended by the process of 'stoving' or 'stifling' in which the cocoons are heated. Some of the cocoons are preserved so that the pupa or chrysalis inside them develops into moths for further breeding.

3.3.2 Reeling Operations

The raw silk is unwound from cocoons and is collected into skeins in the factories known as filature. Here the cocoons are sorted based on their colour, size, shape and texture. Then they are immersed in hot and cold water to soften the sericin so that filament could be unwound into one continuous thread. The whole of the sericin is not removed at this stage as it protects the delicate filament in further operations. 'Reeling' is the process of unwinding the filament from the cocoon. Three to 10 filaments are together reeled for producing the desired diameter of raw silk thread.

3.3.2.1 Production of silk yarns

The reeled silk is formed into silk yarn or silk thread through the process called 'Throwing'. The spinning process of other natural fibres corresponds to it. The raw silk skeins are sorted according to their colour, size, and quantity and washed in warm water with soap or oil for softening the sericin. After drying the skeins, they are placed on reels from where the silk is wound on bobbins. During winding, the silk strands are given desired amount of twist. The strands may be doubled and then given twist in similar or opposite directions. To get equal diameter throughout the length, the yarn is run through rollers. Many kinds of silk yarns are manufactured by giving different amount of twists. Still remaining sericin is removed from silk yarn by the process of 'Degumming' in which the yarn is washed with soap and water for bringing out its natural shine and the soft feel.

3.4 Post-cocoon technology

3.4.1 Stages in silk filament production

3.4.1.1 Cocoon sorting

Cocoon sorting is a process of sorting out defective cocoons from a lot of good cocoons. The process also includes segregating cocoons according to their size. The defective cocoons can be classified as:

- (a) Double cocoons
- (b) Pierced cocoons
- (c) Urinated cocoons
- (d) Flimsy cocoons
- (e) Pointed or constricted cocoons
- (f) Mould attacked cocoons
- (g) Immature cocoons

The process of sorting according to the size is carried with a special equipment known as riddling machine. The segregation of uniform sized cocoons is extremely important since size has influence on cooking and reeling properties.

3.4.1.2 Cocoon stifling

The main purpose of stifling is to kill the pupa inside the cocoon so as to avoid its emergence as a moth and thereby preserving the continuity of the filament. In addition, this operation enables the cocoons to get dried so that the cocoon can be stored for a long period. Cocoon stifling is generally done by the following methods:

- (a) **Sun drying:** In this method the pupa is killed by prolonged exposure (2–3 days depending upon the intensity of sun light) of freshly harvested cocoons to hot sun. The disadvantage of this process is that, continuous exposure to sun hardens the cocoon shell and thereby affects the reelability.
- (b) **Steam stifling:** In this process the pupa in the cocoon is killed by exposing the fresh cocoons to the action of steam for a short time of about 25 min. The process can be done by either basket steaming or chamber steaming.
- (c) **Hot air drying:** The best way to kill pupa is to use hot air. This method is highly useful for good quality cocoons such as bivoltine varieties and facilitates complete driage of cocoons and easy storing.

Other methods of killing the pupa include the use of infrared rays, cold air killing, use of poisonous gases, etc.

3.4.1.3 Cocoon cooking

The object of cocoon cooking is to soften the sericin so that the cocoon shell is loosened enabling the filament unwind smoothly during reeling. Different methods of cooking are adapted such as open pan cooking, three-pan cooking, pressurized cooking, conveyor cooking, etc.

3.5 Silk reeling technology

Silk reeling is the process by which a number of cocoon baves are reeled together to produce a single thread. This is achieved by unwinding filaments collectively from a group of cooked cocoons at one end in a warm water bath and winding the resultant thread onto a fast moving reel. Raw silk reeling may be classified by direct reeling method on a standard sized reel, indirect method of reeling on small reels, and the transfer of reeled silk from small reels onto standard sized reels on a re-reeling machine. The last technique is primarily applied in modern silk reeling processes. Reeling of mulberry cocoons is much more organized in the industry as compared to non-mulberry silk reeling (Sonwalker, 1993). Seri-culturally advanced countries like China have adapted very sophisticated reeling processes with fully automatic reeling machines.

3.5.1 Types of silk reeling machines

3.5.1.1 Country charka

This is a traditional type of reeling machine with crude way of unwinding the filaments from the cocoons. The silk produced from this machine mainly is utilized in the handloom sectors wherein the cost factor of the raw material has to be kept low to enable the rate of the finished product saleable. In addition, the establishment of charka unit does not need any big investment or special skill. This enables charka silk to be sold at a minimum price which is very much wanted by the handloom industry. Also, inferior quality multivoltine and defective cocoons available at lower prices can be reeled more economically on charka than on cottage basin or multi-end basins.

The charka reeling system is an Italian version or floating system of reeling. This version of reeling will improve the reelability of inferior and defective cocoons without considering the quality of silk. Charka (Fig. 3.7), which is a simple device, consists of a large cooking cum reeling pan where boiling water is kept. The cocoons are cooked in it and filaments collected in a bunch after brushing are passed through a hole on an ordinary thread guide device. Later, the thread is crossed with another co-thread for



Figure 3.7. Country charka.

forming a chambon-type croissure in order to agglutinate the filaments and remove the water from body of the thread. Then it is passed through a distributor before it is wound on to a large wooden reel. Four threads are maintained in this device. One person rotates the reel by hand and another person sitting near the cooking pan manipulates the cocoon cooking and reeling.

Charka silk is generally coarse and suffers from many defects since no improved devices such as button/slub catcher and standard croissure system in reeling are used. Charka silk is not re-reeled. Production of silk per charka per day is about a kilogram with coarse denier.

3.5.1.2 Cottage basin

This reeling device (Fig. 3.8) is an improved version over charka and it is designed on the principle of Japanese multi-end reeling machine. Here, cocoon cooking is done separately in a boiling water basin and reeling is done in a hot water basin. Each basin has six ends and each thread is first passed through a button to clean the slubs, waste, etc. Later on, it is independently passed through a travellette-type croissure, which is more efficient than that in charka. After the croissure, the thread passes through a traverse guide and finally on to a small reel.

Since re-reeling is done to prepare standard sized hanks from small reels, the quality of silk produced on this machine is superior to charka silk. Production of silk per day per basin is about 800 g. Superior quality cocoons like bivoltine can be reeled on this device.

3.5.1.3 Multi-end basin

This reeling device is a further improved version over the cottage basin and it is power driven. In multi-end basins, there are some additional attachments such as Jetteboute which picks up the filaments to increase the efficiency of feeding. The distribution system is further improved and individual brake motion for each reel is also provided so that the overall working efficiency of the basin is enhanced. Normally each basin consists of 10 ends.



Figure 3.8. Cottage basin.



Figure 3.9 Multi-end silk reeling machine.

In principle, the multi-end reeling machine (Fig. 3.9) is supposed to be a modern reeling device and it is possible to use superior quality cocoons like bivoltines on these machines with better performance. Raw silk production per day per basin is varying from 600 to 800 g in the above machines and quality of silk is superior compared to that of cottage basin/domestic basin.

3.5.1.4 Automatic reeling

The automatic reeling technique has as its components pressurized cocoon boiling machine, automatic cocoon feeder and a mechanical brushing unit. In addition, it is equipped with automatic denier control device, wherein human error in maintaining the uniformity of denier is avoided to a large extent and thereby ensuring minimum size deviation. Automatic reeling is the improved version over the multi-end reeling method designed and extensively used in Japan for reeling univoltine and bivoltine cocoons. It is a Japanese version or sunken system, which is suitable for better quality cocoons in producing quality raw silk.

In automatic reeling machine (Fig. 3.10), the collective cocoon filaments are initially drawn through Jetteboute, slub catcher or button on to the top croissure pulley, guide pulley, indicator device, lower croissure pulley, croissure guide pulley, tension pulley, brake lever and finally on to the reel, through the ring attached to the traveller bar. Automatic reeling technique is generally suitable only for bivoltine cocoons and is not commercially viable for multivoltine hybrid cocoons (Sonwalker and Krishnaswami, 1980).



Figure 3.10. Automatic silk reeling machine.

3.6 Silk fabric manufacture

Silk seems to have played an important role in the development of loom and weaving technology. Traces of primitive looms and woven fabrics are found in excavations in Egypt, China, India and Peru, but these tribal two-bar bamboo devices including later improved shaft looms – horizontal and vertical – were suitable only for plain or simple patterned coarse weaving or for carpets, tapestry or floor coverings. The silk weavers of China innovated the use of heddle and draw loom, a revolutionary development over traditional primitive loom. India invented a foot treadle for silk weaving, a technical innovation over the ancient loom (Datta and Nanavaty, 2005).

Specialization is necessary for the silk weaving to achieve the required standards of fabrics commercially. Because of the high denier variation in the yarn, it would be better to mix up using box looms.

1. Use of dobby is the minimum requirement in silk weaving.
2. Use of under pick looms for silk weaving provides gentle weaving conditions and permit mixing up of weft by the use of box mechanism.
3. The distance between reed and the backrest is suggested.
4. Abrasion free surface on race board, smooth shuttle surface, rubber covered and porcelain eyes set in heald wires should be used.

In order to manufacture quality fabric and with widths that are acceptable in the international markets, it is desirable that looms for silk weaving are standardized. A standard silk loom should be of under pick type with box mechanism with metallic reed, dobby or jacquard, highly polished rotating type back rest with warp and weft motions. Shuttle looms can be efficient to weave silk fabrics. Quality warp and weft meets the requirements of high speed machine. The number of knots, cleanness and cohesion are also important.

In recent years, silk weaving has seen drastic changes both in the use of sophisticated looms and weaving technology. Today silk fabrics are being successfully woven on most modern shuttleless looms such as Rapier and Air jet with electronic Jaquard and Dobby attachments for producing intricate designs. Despite such developed weaving technology, sophisticated silk brocades and other intricate silks can be produced only on traditional hand looms which even today are operated by master weavers in China, India and other ancient silk weaving countries.

3.6.1 Stages in the silk fabric manufacture

The flow chart representing the stages in the manufacture of silk fabric is shown in Fig. 3.11.

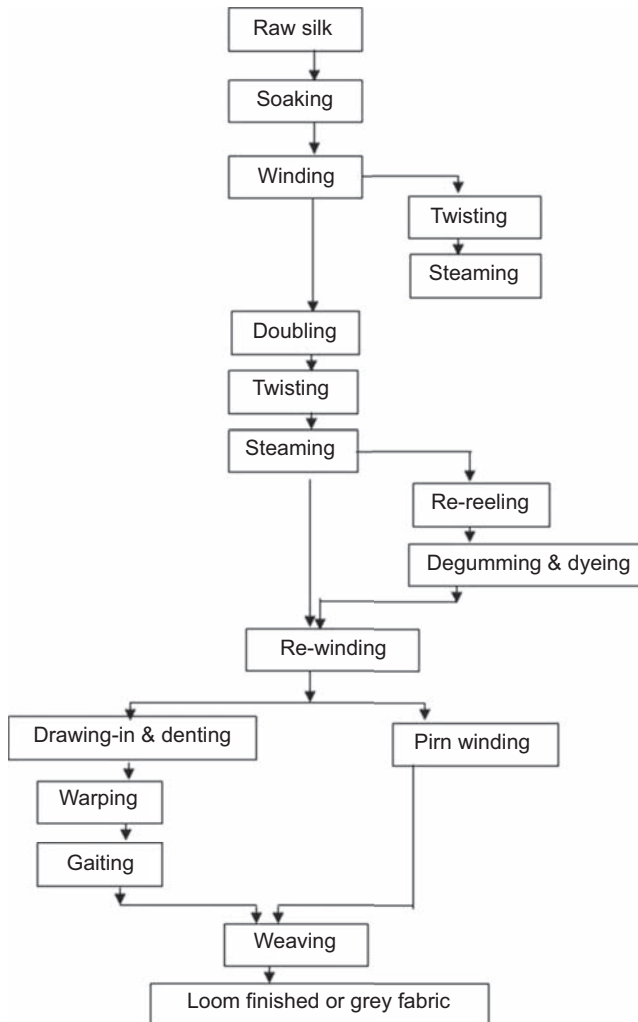

Figure 3.11 Process flow chart for silk fabric manufacture.

3.6.1.1 Soaking of silk

The raw silk hanks meant for weaving are first subjected to soaking process before taking it up for further processing. The main objects of soaking are

1. To soften and slacken the gum.
2. To lubricate the thread and make it more pliable.

The materials used for soaking are soap, oil, water and sometimes salt. Soap is used to soften; oil is to lubricate the thread. Water used for soaking should be neutral and soft. Borax is the popular solvent used for the purpose of soaking.

Conditions: Duration – 12–14 h.

Temperature is around 40°C

The following recipe is recommended for soaking:

Soap: 3%

Oil: 4%

Water: 1: 9.

Borax: Very small quantity.

3.6.1.2 Winding

Winding is the process of putting the raw silk in the form of hanks on to the bobbins. Hard gum spots, loose ends, defective knots are removed in the winding operation. Double flanged bobbins are used in winding machine. It consists of 50–100 bobbin units. Winding should be carried out at $65\% \pm 2\%$ RH. Production per day per drum is nearly 100–150 g.

3.6.1.3 Doubling

Doubling is the process whereby two or more threads from the winding bobbins placed paralleled and wound on to bobbins in order to facilitate twisting together of these yarns. Doubling reduces the irregularities in the yarn improve the strength by overcoming the weak spots.

The doubling machine is more or less like winding machine. Winding bobbins are placed on the creel and the yarn from these bobbins are passed through an individual thread stop motion device, tensioner and thread guide and on to the double flanged bobbin which is mounted horizontally. The doubling tension should be in the range of 0.2–0.3 g/denier. Cover factor of fabric is better for doubled yarns. Doubling takes place in 2, 3, 4 ply or more. Machine capacity is 50–100 bobbins and double sided. Production capacity is 2–4 times that of winding machine.

3.6.1.4 Twisting

Silk is rarely used directly for weaving. It undergoes the process of twisting and the twisting depends upon the type of fabric being produced. The twisting machines used for silk are uptwisters. The doubling bobbins are placed on spindles vertically which are rotating at very high speeds of about 8000 to 10,000 rpm. The twist applied to the thread depends upon the relation between the speed of rotation of the spindle and the winding speed of the take up roller.

$$\text{TPM} = \frac{\text{Spindle speed (RPM)}}{\text{Front roller speed (MPM)}}$$

Twisting affects the brilliancy of a thread. As the twist increases, the lustre of the thread decreases and the thread becomes opaque.

Twisting machine has normally two or three rows of spindles in order to save the spacing. Silk twisting machines are normally double sided. Twist in the silk yarn depends upon the end use of the fabric. Yarns like crepes and georgettes require high rate of twisting. The production of twisting machine/spindle/day is about 25–30 g for 2 ply (20/22 d) yarns.

Types of twisted yarn:

Poil: A silk yarn formed by twisting raw silk. The twist may be very slight or exceed 3000/ mtr.

Tram: A silk yarn formed by doubling two or more silk threads and then twisting them slightly, generally to 80 to 150 TPM.

Crepe: Silk yarn made by doubling several raw silk threads and twisting them to very high levels in the range of 2000–4000 TPM.

Organzine: A silk yarn formed by doubling two or more yarn and twisting them in the opposite direction to that of the twist of the individual ends.

Grenadine: A silk thread formed by doubling two or more ends of poil, and then twisting them in a direction opposite to that of the individual poil ends. Grenadine is 3–4 times more tightly twisted.

Cordonnet: A thick silk thread obtained by doubling and throwing several tram ends in the direction opposite to the twist of the individual tram ends.

Steaming: The twisted yarn has to be subjected to steaming in an autoclave. The steaming process serves to fix the twist given to a thread. The steam makes the thread more ductile. The duration of steaming depends on the depth of the layers of thread on the bobbins and the twist level of the thread. Ten minutes is usually sufficient for organzines while more highly twisted crepes require considerably more time around 2 h.

3.6.1.5 Warping

Warping is the process of collecting individual ends from the creel and transfer on to a beam. Depending on the density of warp ends and the width of the fabric, the number of ends required for the fabric is divided and accordingly the number of sections required for the given sort is decided.

Three different methods of warping i.e. Sectional, Beam and Ball warping are in practice. But sectional warping is more preferred for silk warp because of fine denier and higher number of ends required. Ball warping is in vogue in hand loom weaving sector.

3.6.1.6 Pirn winding

Pirn winding is necessary to prepare weft yarn. Generally the pirns used for power loom are larger and the yarn content will also be more. Pirn winding machine may be automatic or non-automatic. The handloom pirns are smaller size and thus hand operated charkha is used for preparing the pirns.

3.7 Spun silk production

In all the selectors of the silk industry mainly silk worm rearing, reeling, twisting and weaving certain amount of waste is generated. Different types of material wastes are generated during the production of silk goods. An average of (Sonwalker, 1993) 35% of silk waste on the weight of raw silk reeling is being produced in the reeling industry both from mulberry and non-mulberry sector.

3.7.1 Stages in spun silk manufacture

3.7.1.1 Classification of waste

During the process of mulberry silk reeling the different qualities of mulberry silk obtained as bye-products are (Sonwalker, 1993)

1. **Waste from cocoons:** Floss, Spelaia (Italian), discarded cocoons, pierced cocoons, double, stained cocoons, etc.
2. **Reeling waste:** Cooker's waste, reelers waste, Basin reuse or boiling off waste.
3. **Thread waste:** Re-reeling, winding or throwster's waste, weaving waste (Hard waste).

The silk waste is normally collected by the trading agencies from silk filatures and supplied to spun silk manufacturing units. A spun silk mill can be broadly divided into five main divisions, namely,

1. Degumming
2. Dressing and combing
3. Preparatory
4. Spinning
5. Finishing

3.7.1.2 Degumming of waste silk

The purpose is to eliminate sericin to prepare the fibres for subsequent mechanical process. There are two methods.

1. Soap and soda boil method
2. Enzymatic degumming

Soap and soda boil method

It involves treating different qualities of waste silk with slightly alkaline soap solution at boil for about 1 h. The liquor is heated by steam coils from the bottom. The material is worked either manually or mechanically in the vat where liquor ratio is about 1:30, 25% soda is prepared and the material is worked for 45 min and the liquor is discharged out. A second boil is given with 25% of soap solution and washed twice in the same vat.

The degummed material is hydro extracted in order to squeeze out water. After squeezing, the material is dried in open air during summer and heated in closed chambers during winter.

3.7.1.3 Dressing or combing

Degummed waste is processed in the ‘opening’ machine; in order to transform the material from a tangled mass of fibre into a ribbon in which the filaments will be more or less parallel. This is done on a machine known as opener. The opener has two feeding rollers of small diameter armed with small metallic points and another drum with larger diameter. The material is fed to the roller on a belt and passed by them to the teeth of the rotating drum. The fibres deposited on the drum are more or less parallel and removed when it reaches certain weight.

The drum of the combing frame or circular dressing frame has a diameter of 1.7 m and turns slowly. The combing mechanism consists of two rollers, studded with metallic points as wide as the drum, but of much smaller diameter, one at each side of the lower part of the drum and turning in opposite directions, so that the material is combed first in one direction and then in the other.

3.7.1.4 Preparatory

After the dressing process, the first preparatory state is the cleaning of slivers. They are inspected by transparency on a glass panel, defects being corrected and remaining foreign matter removed by hand.

Spreader

The spreader first simply couples the slivers, and then gradually draws out the ribbon until it is of regular size. The degree of stretching by the spreader is from 1:6 to 1:12 (draft) according to the quality of the material. The ribbon is gathered on the surface of a large drum and then proceeds to a whole series of drawing operations.

Drafting principle

Material is fed into a back set of rollers and delivered from the front set of rollers. Rate of delivery always is faster than the rate of feed. Suppose front roller delivery (surface speed) is 10 times the surface speed of back rollers, then the draft would be 10. If the fibres are fine and long, the drafting is easier and hence higher drafts can be employed as compared to short and coarse fibres.

Drawing

This series of preparatory drawing operation takes the ribbon or sliver through six different drawing machines in each of which, it is submitted to extension, varying from 1:6 to 1:10.

Roving

Here, the preparatory stages are concluded with a final extension of about 1:8. The completed yarn or roving, which the final operation has also been given a slight twist, is now ready to be spun on the ring spindle machine.

Twist

As the drafted material from roving stage becomes finer and finer, there will be few number of fibres in the cross-section and also the fibres are parallelized. In order to bind the fibres to give sufficient amount of strength to the material, twist is necessary. Twist in the yarn increases the strength to a certain extent. So, for selecting the appropriate amount of twist for a particular material, there are twist constants,

$$\text{TPI} = \text{Twist factor} \times \sqrt{\text{Count}}$$

$$\text{Also, TPI} = \frac{\text{Spindle speed (RPM)}}{\text{Front roller delivery in inches}}$$

Production/spindle for 8 h. (g)

$$= \frac{\text{F.R.D in inches} \times 60 \times 8 \times 453.6}{36 \times 840 \times \text{Cotton English count}}$$

3.7.1.5 Spinning

Ring Frame: The ring spindle has a spindle surrounded by a teel wheel which rotates a small metal ring attached to it. The spindle rotates at a speed of about 6000–7000 rpm. The yarn is drafted to an extent of 1:15 or 1:30 (drafting) as it passes through the small ring (traveller), which is also rotating swiftly.

Principle of Spinning:

In ring spinning, all three operations i.e. drafting, twisting and winding take place simultaneously.

Drafting — Takes place by means of a set of rollers which are called drafting rollers.

Twisting — Takes place due to the difference in speed of spindle or traveller and the front roller delivery.

Winding — Takes place due to the traveller which slightly lags behind the spindle speed, as there is a yarn drag.

3.7.1.6 Finishing

Doubling

Two or more threads will be combined to make weaving thread or sewing thread respectively. After doubling, the second twist is given on the throwing machine, the number of turns varying with the desired property of the thread.

Gassing

The twisted yarn is next passed on to the cleaning and gassing frame in which the yarn is made to pass through a burning gas flame in great friction which is obtained by the yarn being wound round a number of runners, both before and after the flame, thus making the yarn repeatedly pass through the flame. The thread will be passed at a speed of 500–600 mpm. The friction given by the runners further helps to eliminate

any weak portion in the thread and also neps and other impurities and the flame helps to burn away the loose hairy protruding fibres and small neps and imparts a gloss to the silk. The adhering burnt particles are removed from the thread by passing the singed thread between rotating steel rollers, the process being termed as cleaning. These gassing and cleaning operations are performed by a single machine.

Reeling

The gassed yarn is then reeled on reeling frames (straight reel or cross reel) to transfer it into hank form. The hanks are then dressed and folded and packed in bundles which are then press packed in bundles and into bales ready for the market. The usual count (Metric) of the yarn spun in Indian spun silk mills are 60s, 140s and 210s (two fold).

3.8 Future trends in natural silk production

Silk is considered as one of the finest natural fibres in the world. This beautiful fibre exhibits excellent properties such as enormous tensile strength, extensibility combined with very good comfort and dyeing behaviour. The fibre cannot be ignored in the global context as it is the only natural fibre available in continuous filament form. It is synonymous with luxury, beauty, sensuality and elegance. Its qualities are unrivalled by any other fibre. It is light but strong, smooth, soft and versatile and as a natural fibre it 'breathes' and is more comfortable to the skin. Silk, which used to be perceived as a luxury fibre worn only by the rich, but in the early 1990s silk became 'democratized' with the rising popularity of machine washable sandwashed silks.

Silk accounts for less than 1% of the world fibre market by volume but its importance in value terms is several times greater. Exports of silk goods from major silk producing countries like China have exceeded more than US\$3 billion in recent years. The United States has been a major importer of silk from China and India. India being the second largest producer of silk has a major potential in improving its production capacity. Product Development and Diversification for exclusive silk goods has been a pressing need of the Indian Silk Industry. In the emerging silk scenario where India is consolidating its position as the second largest silk producer in terms of quality as well as quantity, diversification of products to address market needs is critically important. Indian silk industry has certain inherent strength that need to be projected in the right perspective and at the same time harnessed effectively. Export market base needs to be widened and the range of products has to be broad based. At the same time quality products should meet the customer's expectations.

The domestic market for silk is quite substantial. Product diversification into casual wear and alternate end uses and focus on bringing the growing upper middle-income group in addition to the high-income group into the fold of silk products would lead to greater value addition in domestic silk production.

Growing market awareness has been evidenced in the recent years for the non-mulberry or so called 'Vanya' silk products especially Tasar and Eri silk in the domestic markets of China and India. Product development and diversification in Tasar, Eri and Muga has been almost a virgin area in India. Importance of new designs,

motifs and products has of late been recognized in Vanya sector and thrust is being given to product development, which will not only contribute in diversification of the product but also enlarge the market share. Nevertheless Mulberry silk which constitutes the bulk of the silk production in India and China is also being targeted for a higher clientele and product range.

The future of silk through 21st century seems quite bright. Though consumption is likely to rise despite its high prices, the question mark is whether the silk production will keep pace with the shooting demand. Japan is foremost in silk consumption; Chinese enjoying high standard of living are also boosting demand for silk within the country and almost 85% of rising silk production in India is consumed within the country and has to import more than 5000 MT every year to meet shortfall in demand. The ecology factor is pushing demand for silk in Europe and the United States.

3.9 Sources of further information and advice

Recommended text books are mentioned in the references. The periodicals such as *Indian Silk*, *Indian Journal of Sericulture*, *Sericologia* can be referred for information on Indian sericulture, silk technology and other related topics. Text book on Handbook of Natural Fibres 1st Edition published by Woodhead Publishing (2012) can be referred for various aspects of silk and other natural fibres. Occasional articles are found in *Journal of Applied Polymer Science*, *Journal of Textile Institute*, *Textile Research Journal* and *Indian Journal of Fibre and Textile Research*, *Journal of Natural Fibres (Taylor and Francis Group)*. Additional information on sericultural aspects of silk, silk fabric manufacture, dyeing, printing and processing aspects are available online on www.indiansilk.kar.nic.in, www.fao.org.

Acknowledgements

I would like to acknowledge the assistance and contribution rendered by my colleagues Mr. S.M. Chandrashekar, Senior Lecturer and Mr. Y.N. Dinesh, Assistant Professor, Department of Textile Technology, BIET, Davangere for timely completion of this chapter.

In addition, I would like to express my appreciation to the Editor of this book and Woodhead Publishing Limited for giving me the opportunity to contribute this chapter.

References

- Altman, G.H., Diaz, F., Jakuba, C., Calabro, T., Horan, R.L., Chen, J., et al., 2003. Silk-based biomaterials. *Biomaterials* 24, 401–416.
- Asakura, T., Kaplan, D.L., 1994. Silk production and processing. In: Arntzen, C.J., Ritter, E.M. (Eds.), *Encyclopedia of Agricultural Science*, vol. 4. Academic Press, New York, pp. 1–11.
- Asakura, T., Yao, J., Yamane, T., Umemura, K., Ulrich, A.S., 2002. Heterogeneous structure of silk fibers from *Bombyx mori* resolved by ¹³C solid-state NMR spectroscopy. *J. Am. Chem. Soc.* 124, 8794–8795.

- Becker, N., Oroudjev, E., Mutz, S., Cleveland, J.P., Hansma, P.K., Hayashi, C.Y., et al., 2003. Molecular nanosprings in spider capture-silk threads. *Nat. Mat.* 2, 278–283.
- Bell, F.I., McEwen, I.J., Viney, C., 2002. Fibre science: supercontraction stress in wet spider Dragline. *Nature* 416, 37.
- Craig, C.L., Hsu, M., Kaplan, D., Pierce, N.E., 1999. A comparison of the composition of silk proteins produced by spiders and insects. *Int. J. Biol. Macromol.* 24, 109–181.
- Craig, C.L., 1997. Evolution of arthropod silks. *Annu. Rev. Entomol.* 42, 231–267.
- Datta, Rajat K., Nanavaty, M., 2005. *Global Silk Industry: A Complete Source Book*. Universal Publishers, USA, p. 171.
- Dhavalikar, R.S., 1962. *J. Sci. Indus. Res.* 21 (C), 261–263.
- Guljarni, M.L., 1992. Degumming of silk. *Rev. Prog. Colour.* 22, 79–89.
- Hamamura, Y., Kuwata, K., Masuda, H., 1966. Effect of gallic acid on the growth of the silkworm larvae *Bombyx mori* L. leaf. *Nature* 212, 1386–1387.
- Hamamura, Y., 1959. Food selection by silkworm larvae *Bombyx mori*. *Nature* 183, 1746–1747.
- He, S.J., Valluzzi, R., Gido, S.P., 1999. Silk I structure in *Bombyx mori* silk foams. *Int. J. Biol. Macromol.* 24, 187–195.
- Hiroshi, S., Hiro-aki, Y., 1994. Low-cost artificial diets for polyphagous silkworms. *Jpn. Agric. Res. Q.* 28, 262–267.
- Jolly, M.S., Sen, S.K., Sonwalker, T.N., Prasad, G.K., 1979. Non-mulberry silks. In: Rangaswami, G., Narasimhanna, M.N., Kashivishwanathan, K., Sastri, C.R., Jolly, M.S. (Eds.), *Manual on Sericulture*. Food and Agriculture Organization of the United Nations, Rome, pp. 1–178.
- Juming Yao, Asakura, T., 2004. Silks, *Encyclopedia of Biomaterials and Biomedical Engineering*. Marcel Dekker Inc., pp. 1363–1370
- Mahadevappa, D., Halliyal, V.G., Shankar, D.G., Bhandiwad, R., *Mulberry Silk Reeling Technology*, 2001. Oxford and IBH publication Co., India.
- Paulo Carboni, 1952. *Silk, Biology, Chemistry and Technology*. Chapman & Hall Ltd, London.
- Sheu, H.S., Phyu, K.W., Jean, Y.C., Chiang, Y.P., Tso, I.M., Wu, H.C., et al., 2004. Lattice deformation and thermal stability of crystals in spider silk. *Int. J. Biol. Macromol.* 34, 325–331.
- Sonthisombat, A., Peter, T., 2004. *Silk: Queen of Fibres - the Concise Story* by. Speakman, Department of Textile Engineering, Faculty of Engineering, Rajamangala University of Technology Thanyaburi (RMUTT).
- Sonwalker, T.N., Krishnaswamy, S., 1980. Working of an Automatic Reeling Machine in CSR&TI, Mysore. *Indian Silk*, November.
- Sonwalker, T.N., 1969. Investigations on degumming loss and spinning performance of pierced and cut cocoons in silk worm Mori-L. *Indian J. Seric.* 7 (1), p61.
- Sonwalker, Tammanna N., 1993. *Hand Book of Silk Technology*. Wiley Eastern Limited, New Delhi, p. 181.
- Tanaka, K., Kajiyama, N., Ishikura, K., Waga, S., Kikuchi, A., Ohtomo, K., Takagi, T., Mizuno, S., 1999. Protein structure M. *Biochem. Biophys. Acta* 1432, 92–103.
- Watanabe, T., 1958. Substances in mulberry leaves which attract silkworm larvae. *Nature* 182, 325–326.
- Yamada, H., Kato, Y., 1966. Chlorogenic acid as an indispensable component of the synthetic diet for the silkworm. *Proc. Jpn. Acad.* 42, 399–403.
- Zhou, C.Z., Confalonieri, F., Medina, N., Zivanovic, Y., Esnault, C., Yang, T., Jacquet, M., Janin, J., Duguet, M., Perasso, R., Li, Z.G., 2000. *Nucleic Acids Res.* 28, 2413–2419.

This page intentionally left blank

The use of flax and hemp for textile applications

4

Małgorzata Muzyczek

Journal of Natural Fibers, Taylor & Francis Group, Poznan, Poland

4.1 Introduction

The dominance of natural fibres in the textile industry came to an end at the beginning of the 20th century, in the 1920s. By the end of the 1990s only about 50% of world textile production originated from natural raw materials. In the 1960 and 1970s, a time of fascination with chemical fibres, the advantages of natural fibres were denigrated. Today, we can observe a reversed trend: the importance of natural fibres is being recognized once again and modern man-made fibres emulate the properties of natural ones. Due to properties connected with their microstructures, natural fibres meet the high requirements for everyday comfort and leisure apparel. Nowadays, a balance of coexistence and competition between natural and man-made fibres is maintained.

The largest sector of the global apparel market is casual leisurewear. The sportswear sector is growing the fastest; its global apparel expenditure increased from 7% in 1996 to 13% by 2010 (Muzyczek, 2000).

Quality is among the most important attributes in selecting a garment for purchase; nine out of ten consumers say that knowing the quality of a garment is one of the most important considerations. It is worth mentioning that consumers worldwide closely associate quality with content. Like US consumers, the majority of global consumers (52%) regarded natural fibres as being of higher quality than synthetic ones (Ulrich, 2007).

Natural fibres cannot be replaced by synthetic fibres due to their intrinsic biodegradable and wear comfort properties. Renewed enthusiasm for natural fibres is likely to increase their presence in the marketplace. It is predicted that natural fibres will mostly be used in the production of underwear and other apparel worn close to the body, especially for higher level products, while man-made fibres will find different applications. Blends will be of particular importance, including so-called composites, and new fabric and apparel designs, such as multi-layer fabrics. These will have man-made outer layers, while natural fibres will make up the inner layers, which are in contact with the skin. This will hide some unfavourable features of man-made fibres while fully utilizing the advantages of natural fibres.

Among the most important advantages of natural fibres are

- air permeability,
- hygroscopicity,
- no emission of harmful substances,

- no allergenic effect (except wool),
- no electrostatic charge accumulation (except wool),
- biodegradability,
- renewability,
- in some cases, medicinal properties.

Cotton, wool, flax and silk are the main natural fibres used in the clothing industry. Cotton holds the main share; approximately 80%, while the remaining 20% encompasses fibres such as jute, wool, flax, silk, ramie, hemp, sisal and kenaf. But the potential for further growth in cotton production is limited.

Climate change is one of the major concerns of 21st century. Tremendous efforts are being made to tackle the climate change issue of the globe. Many stakeholders are therefore optimistic about the market for fibres from crops such as flax and hemp.

In contrast to the refined, lightweight sophistication of man-made products, there is new emphasis on natural fibres because as is known, flax and hemp fibres are green by nature. But, as a 100% renewable raw material, these sustainable fibres are also perfectly recyclable, biodegradable and compostable.

4.2 Types of flax used for textile applications

Flax, which is one of nature's strongest vegetable fibres, was also one of the first to be extracted, spun and woven into textiles. Linen fabrics are valued both by designers and users for their smoothness, silky gloss, durability, comfort, and easily recognizable, specific appearance that denotes their natural origins. The secret of the happy and enduring alliance is linen's great capacity to absorb — a hollow fibre, it holds dyes wonderfully, a perfect affinity to inspire designers. Even after a long pre-washing, flax fibres remain sturdy and are unrivalled in softness and suppleness.

Using the proper fibre, suitable for final use of the textile product, as well as using selected technological process determines properties of the ready-made product.

4.2.1 *A review of the types of flax used in the production of textiles*

Industrial processing of fibres, especially for textiles, demands homogeneous and high quality raw material. The expectations regarding flax and hemp quality depend on the final destination of the fibres.

At the INF&MP the quality parameters were elaborated for the following raw materials:³

- Long flax for hackled yarns.
- Short flax for carded yarns.
- Wool-like homomorphic flax for blended yarns.
- Cotton-like flax for blended yarns
- Green decorticated flax.

4.2.1.1 Long flax fibre for hackled yarns

Scutched long flax is subjected to a hackling process. During this process the fibre is divided into long hackled and short – machine noils (Table 4.1).

Hackled long flax is for traditional flax and is a wet or dry spinning system for yarn production. The wet spinning system with boiling is used in producing thinner worsted yarns, while the dry spinning system yields yarns of higher linear density. For example, the Linificio company offers linen and hemp yarns. These raw yarns are the classical wet long and short staple linen, semi-wet long or mixed with tows linen, bleached or natural, available from 3.5 to 90 Nm.

4.2.1.2 Short flax for carded yarns

Short flax, scutching noils and matted tow are processed in carding wet (including boiled and bleached roving) and dry spinning systems. The linear density of carded yarn results from the grade and spinning system applied (Table 4.2).

Flax homomorphic wool-like fibre for blended yarns.

The main raw material for producing flax homomorphic wool-like fibre is flax dew-retted homomorphic fibre, which is obtained from processing dew-retted straw.

Short flax dew-retted noils can be substituted for the above; these are obtained through mechanical hackling of long flax dew-retted fibre.

Flax wool-like fibre should meet the following quality parameters:

- average length of fibres should be about 60–90 mm,
- linear density maximum should be 2.3 tex,
- impurities content should be no more than 0.4%,
- maximum length of fibres should be 130 mm, with a long-fibre content not higher than 5%,
- average thickness of fibres should be 40–50 μm .

Table 4.1 Parameters of flax scutched and hackled fibres.

Raw material	Length (mm)	Thinness (tex)
Flax long scutched	300–1400	4.0–6.0
Flax hackled scutched	350–700	1.4–3.3

Heller, K., The team of INF&MP, 2010. Non-food Crops-To-Industry Schemes in EU27, Progress Report of Project Crops2 Industry.

Table 4.2 Parameters of flax tow.

Raw material	Length (mm)	Thinness (tex)
Scutched tow	80–140	3.5–5.5
Matted tow	140–250	4.5–6.5

Heller, K., The team of INF&MP, 2010. Non-food Crops-To-Industry Schemes in EU27, Progress Report of Project Crops2 Industry.

4.2.1.3 *Flax cotton-like fibre for blended yarns*

The types of fibre mentioned above should be mechanically or chemically processed to meet the technological requirements of cotton-like fibre. When manufacturing cottonized fibre from flax fibre, the homogeneity and quality of the product in terms of its length, linear density and impurities content, are important.

So-called cottonization can be conducted by chemical means, by enzymatic methods, by using ultrasound, or by the steam explosion method.

4.2.1.4 *Green decorticated fibre*

Raw material obtained from the following sources can be used to produce decorticated fibre:

- oil flax, the straw of which contains low quality fibre;
- fibrous flax plantations, which produce fibre unsuitable for processing into yarn, namely:
 - heavily weeded plantations,
 - seed plantations,
 - plantations infected with diseases,
 - plantations yielding short and insufficiently retted straw.

Because of its length (over 15 cm) and chemical composition, green decorticated fibre is a good material for producing long fibrous pulp, which is used for manufacturing high quality paper and as fillers in composite materials.

4.2.2 *The technical properties of flax fibres*

Moisture absorption is very high. Flax fibre, like cotton, is mainly a lignocellulosic polymer, but its structure is more crystalline, making it stronger, crisper and stiffer to handle, and more easily wrinkled. It absorbs and releases water quickly, making linen comfortable to wear in hot weather.

Linen swells considerably when wet and is very absorbent. At a relative humidity of 65%, moisture absorption is around 8%–10%. At 100% relative humidity, absorption is approximately 20% but the fabric does not feel moist. Due to the fibres' constant humidity, the electrostatic charge is very low. This principle was confirmed by research results from the INF&MP (Figs. 4.1 and 4.2). (Zimniewska et al., 2004a, 2004b).

Heat retention is low. Linen conducts heat well. Pectin present in the fibres creates a smooth surface, and strong cohesion between the ligaments within a bundle, without capturing any air bubbles. This results in the low heat retention and 'cool' feel that are very much characteristics of linen. If the fabric density is low, the air permeability is also very low. For these reasons, linen is used predominately for summer clothing, because it assists with the regulation of body heat. Linen has the lowest *stretchability* and elasticity of all spinnable textile raw materials: 1.5%–3% stretch at break.

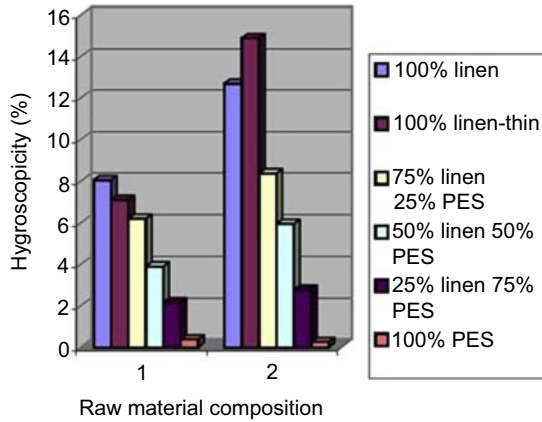

Figure 4.1 Hygroscopicity of linen, polyester and blended fabrics in different humidity conditions; 1. at 65% relative humidity of air, 2. at 100% relative humidity of air (Polish Standard PN-80/P-04635) (Zimmiewska et al., 2004a).

This makes the processing of flax more difficult, but is an advantage when manufacturing belts, straps, cords and threads. Other characteristics include:

Tensile strength. Dry: approximately 27–73 cN/tex with long flax. Approximately 18–35 cN/tex with tow yarns. Wet: approximately 130%–140% of tear test dry. During the production of linen yarns and threads, advantage is taken of the high tensile strength of flax fibres. Compared to cotton, flax fibres have a high crystalline proportion, and their resistance to chaffing is low.

Resistance to creasing: very low, therefore prone to wrinkling. Due to the low elasticity of linen (fabrics do not deform), its resistance to creasing is also very low (in dry and wet

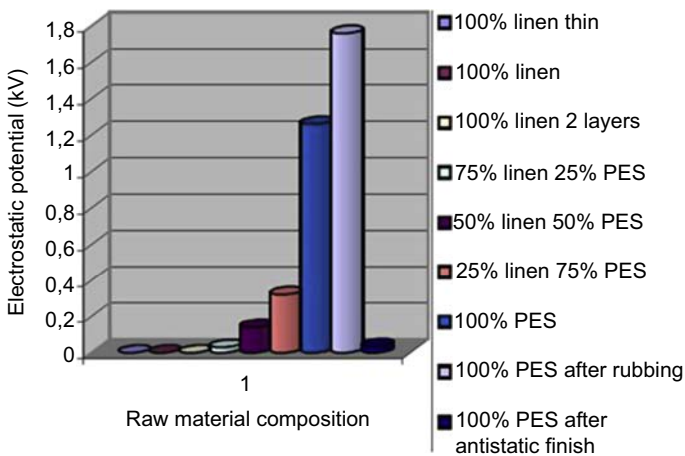

Figure 4.2 The electrostatic potential on the surface of tested clothes (Zimmiewska et al., 2004a).

conditions). This can be reduced through processing, finishing and blending with other types of fibres.

Temperature/ironing: max. 120°C. Linen can be washed, even at elevated temperatures. Linen aids restful sleep. Research has shown that people sleeping on linen bedding had a high immunoglobulin- α level and, because of this, they were sound sleepers and their immune systems were stronger. (Kozłowski and Manys, 1999)

Linen sheets are the epitome of coolness and, due to the fabric's temperature-regulating properties, nothing matches the way they feel. Linen breathes, just like skin. It feels as light as a feather on the body. In hot weather, it absorbs moisture and excessive heat; in cool weather it retains body heat. Linen is healthy, and it is a perfect pampering product (Bowerman, 2005). It is anti-static, anallergic, and can help to soften and preserve the skin due to its natural pH balance.

The smoothness of linen fibres, together with the small hollows in their structure, ensures that products made of linen are highly resistant to soiling and are bacteriostatic.

The sheen of linen depends on the type of applied retting and the extracting method. Dew and water-retted flax has a pleasantly mild and natural sheen because the majority of its fat and wax contents are retained during processing.

Products made of flax fibre offer efficient protection from ultraviolet (UV) radiation, due to the lignin content of its chemical composition. It is therefore especially suitable for creating summer collections of clothes worn in warm climates.

4.2.3 The processing (spinning, weaving, knitting, etc.) of flax and hemp fibres for textiles

The linen and hemp manufacturing process is complicated and requires great skill at each stage of production.

Hemp and flax textile processing technologies are very similar, because the textile properties of hemp are very close to those of flax. Without a deoxyribonucleic acid (DNA) check, even the most experienced textile expert cannot tell the difference between flax fabric and hemp fabric. The scheme of production from fibre to fabric is presented below:

4.2.3.1 Fibre processing

The steps involved in fibre processing are

- softening/lubricating,
- hackling/carding/drawing,
- spinning,
- weaving,
- finishing/dyeing/bleaching.

Recent developments in finishing include softwash and aero finishes for a relaxed look. New easy-care finishes cut down creasability, making the fabric fully washable and tumble-dry friendly (Irish Linen Guild, 2010).

4.2.3.2 Linen

Linen is manufactured as open-end and ring, single and twisted, wet and dry spun boiled, bleached and dyed yarns on cones, bobbins and hanks, for knitting and weaving applications, from flax and flax-rich blends.

4.2.3.3 Hemp

The most important advantages of hemp are: (Muzyczek and Kozlowski, 2004)

- high hygroscopicity and fast moisture transport;
- high heat absorption, allowing for adaptation in changing environmental conditions (The porous nature of hemp allows the fabric to breathe making it cool in warm weather. The same principal applies to cooler weather. Air trapped in the fibres is naturally warmed by the body keeping you warm in the garment);
- its strength does not collect electrostatic charges, which is especially important when working with electronic devices;
- ability to protect against UV radiation (due to lignin content). Fabrics with at least 50% hemp content block the sun's UV rays more effectively than other fabrics;
- very high adsorbability to toxic gases, which is an advantage in household textiles;
- it is more mildew resistant than cotton, it is also naturally resistant to mould;
- is porous and absorbs well therefore when dyed it retains its vibrant colour;
- hemp fibre is strong and will hold its shape, stretching less than other natural fibre. This keeps the garment from stretching out or distorting with use.

Hemp is, however, characterized by a number of unfavourable features for spinning, such as

- thickness and low uniformity,
- stiffness,
- low elongation.

These features decrease the speed of spinning and make it more difficult. *Points on Spinning and weaving.*

Hemp, like flax, will produce a finer yarn when wet spun, although hemp can be both dry and wet spun. Linen spinning machinery can sometimes be adapted for hemp. Today, high-speed, computer-controlled looms are operated under the watchful eye of an experienced weaver, giving the industry an ideal mix of automation and skill.

A hackled hemp fibre of reasonable quality has a decitex count of approximately 40, compared to 25 for flax.

Hemp yarn is currently produced in various weights, for example from 2.6 to 54 Nm. Fabric is available in a range of weights, with 270–540 gsm. Hemp fabric blends with wool, cotton, silk or synthetics are also being produced (Riddlestone et al., 1996).

4.2.3.4 Cottonization of hemp fibres

Using specially developed machines and an array of degumming technologies, Chinese scientists have successfully reduced the lignin content in hemp fibres from 8% to 10% to as little as 0.2%. As a result, it is possible to cottonize hemp fibre

into fine, soft and workable textile fibres for cotton and wool systems, and for blending with man-made fibres.

This technology is now being used in China's first commercial-scale hemp processing mill, in Xishuangbanna, Yunnan Province, which has the capacity to process 50,000 tonnes of hemp fibres a year. The fibres manufactured in Xishuangbanna are mainly used in cotton-hemp blends (Zhang, 2008).

4.2.3.5 Hemp viscose fibre

Chinese scientists have also successfully made viscose fibres (both filament yarn and staple fibres) from hemp core hurd (shive). Hemp rayon staple is ideal for cotton textiles. Hemp viscose fibre has excellent antibacterial properties, just like natural hemp. This has been established in the laboratory of the Japanese company Asahi Kasei (Zhang, 2008).

4.2.3.6 Knitting

In the past few years, European linen has made inroads into the knitting sector. Pure linen, and minimum 50% linen mixes, abounds in the full gamut of styles, from casual to city chic. Linen yarn intended for knitting has a lower twist than that intended for weaving purposes. Knits are essential items in fashion today for both men and women. Linen has carved out a significant market share, thanks to the efforts of flax spinners, who produce smooth, fine yarn to meet the technical requirements of industrial machinery. Circular and flatbed knitting produce high-end jerseys with a distinctive handle and sheen. Their fluid drape gives the measure of their crease-resistance.

Like wovens, linen knits have all of the natural qualities of the fibre, plus they do not wrinkle. Thanks to their easy-care qualities, they are ideal for travelling.

Flat or circular knits play up openworks, 3D effects or Jacquards for light materials worn next to the skin. For example, the Petit Bateau Company (France) uses linen knits, offering a collection of tops, T-shirts, tank tops and nightshirts in 100% linen, also for children.

Similarly, lacemakers have rediscovered linen yarns, which can be used in creating underwear.

4.2.4 Textile fibres for reasonable blends

Textiles nowadays are often made from blended yarns (with synthetic or other natural yarns such as cotton, cashmere, viscose, silk, polyester, elastan and acrylic) to improve wear comfort or appearance of the end product (gloss, elasticity, linen-silk, linen-leather, linen jersey and coated, technical or quilted linens).

Innovative proposals for blends include linen/crêpe silk, linen/silk, linen/lurex, linen/bamboo, and linen/Tencel, developed in cooperation with Lenzing AG and Hungaro Len Kft (Kft, 2010; Kati, 2002). Blended yarns are produced on traditional ring spinning systems, and are wet spun

- raw,
- pre-bleached on rove,
- pre-boiled on rove.

The Modal or Tencel blended yarns, in comparison with 100% linen, are softer to the touch, shinier, and have fewer thickness irregularities and neps. The elongation of 100% linen yarn is less than 2%, but blends have a higher elongation, and so a better weaving performance is expected.

- Linen yarns are used as plain colours and are resin-treated.
- Linen fabrics can be resin or metallic coated, printed, or dyed.

4.3 Applications and examples

Textile applications of linen are shown in Fig. 4.3, while Fig. 4.4 shows world consumption by geographical region. The main consumers of textile linen products are the United States and west European countries.

According to information provided by CECLinen textile consumption in Europe is <1% of textile fibres consumed worldwide (<http://www.mastersoflinen>).

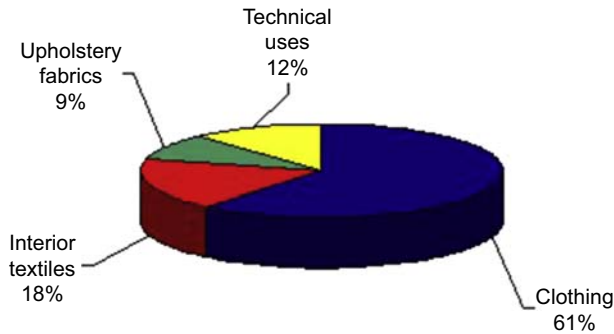

Figure 4.3 Textile linen area of application (<http://www.mastersoflinen>).

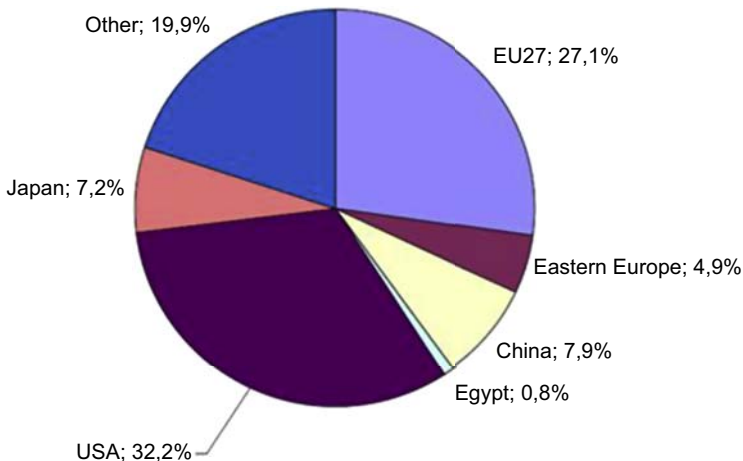

Figure 4.4 World linen consumption in 2007 (<http://www.mastersoflinen>).

4.3.1 Textile products end uses containing flax and hemp

Fine and regular long flax fibres can be spun into yarns for linen textiles. More than 60% of linen goes to clothing manufacturers, who value its exceptional coolness in hot weather. The legendary linen suit is a symbol of breezy summer elegance.

Because linen is natural, healthy, fresh and protective, it plays a leading role in the fashion scene, both traditional and modern. Since clothing trends are mainly based on comfort, leisure and relaxation, linen plays a decisive part today. Linen lets skin breathe freely and quickly absorbs perspiration. Bedclothes made of pure linen provide the best sleeping comfort, and have healthy and curative properties. Linen has also taken on a leading role in the knitwear sector, thanks to new technology (Kozłowski et al., 2009).

Linen fabric maintains a strong traditional niche among high quality household textiles, including bed linen, furnishing fabrics and interior decoration accessories. Linen also has a wide variety of applications in interiors, from upholstery fabrics to curtains. Its natural qualities make it suitable for wall coverings: linen does not slacken whatever the humidity or temperature of the room. Its colours are fast to sun or artificial light. Linen is resistant to shocks and scratches. Because it is natural, it does not catch dust. A linen wall covering provides good thermal and sound insulation (Athane, 2009) and is safer in fire conditions than man-made fibres.

Shorter flax fibres produce heavier yarns, which are suitable for kitchen towels, sails, tents and canvas. Because linen fabric is soft, does not lint, can be washed at high temperatures, and has a great capacity for absorbing moisture, it is a suitable fabric for bathrooms and table linen. Linen's softness increases with time and use.

Traditional hemp textiles were too coarse for apparel, but improved techniques allow the creation of lighter and softer textures, and thus enhance utility. Hemp makes an excellent furnishing fabric, especially for drapes. It is also used as 'bottom weights' in clothing, including jeans and sportswear, either in the form of 100% hemp fabric or blended with cotton, wool, flax or synthetics.

The CRAILAR process for enzymatic degumming of hemp, developed by Naturally Advanced Technologies Inc. (Canada) in collaboration with the National Research Council of Canada, involves the processing of bast fibres such as flax and hemp using a proprietary enzyme wash. This gives them an organic cotton-like texture, while retaining durability and strength (Jones, 2009).

Different grades of flax and hemp tow and short fibres are released during the scutching and hackling processes. Some are better suited to staple fibre spinning and rope making, for nonwovens and fibre composites, and in non-wood speciality paper pulp production.

Lower fibre grades are used as reinforcement and filler in thermoplastic composites and thermoset resins, which are employed in automotive interior substrates, furniture and other consumer products. There is also research underway to replace graphene in industrial batteries with hemp filaments (<http://hempalliance.org.a>).

Textiles are widely preferred for anything that moves: less weight requires less energy!

True to the philosophy of "take steel out, put textile in", the textile material combines many positive properties in one: it does not rust, it lasts longer, is lighter

and requires less maintenance — say Ingeborg Neumann, President of the German Textile and Fashion Industry ([Aishwarya Anand et al., 2018](#)).

4.3.2 A brief overview of the financial and economic value of hemp fibres

Hemp fabrics are similar in appearance, handle and other properties to flax, and there would be little to be gained in producing hemp unless it had some advantageous unique selling point ([Riddlestone et al., 1996](#)).

Historically, hemp fabrics have been used as lugsails, sacks, ropes and canvas, because hemp swells more in water than linen. Indeed, in certain respects, hemp has some disadvantages when compared to flax. A reasonable quality hackled hemp fibre has a decitex count of approximately 40 compared to 25 in the case of flax. Its spinning limit (fineness) would seem to be lower, about 12 Nm compared to 35 Nm or more for flax, though extremely fine hemp yarn at 30 Nm is apparently produced in China ([Daenekindt, 2004](#)). Bearing in mind hemp's similarity to flax and its likely lower spinning limit, it would seem that hemp would only be successful if it was cheaper; say in the \$7–10/kg range (for long fibre). If sold at the same price as flax, the market for hemp would be small.

It is not possible to estimate the size of the potential hemp market except to say that it seems large, being somewhere, depending on price, between cotton's 50% of total world fibre consumption and flax's 3% ([UK Cannabis Internet Activist \(UKCIA\), 2010](#)). It is possible to grow hemp organically, which is difficult with flax, and this could help hemp gain a place in the small but growing market for eco-friendly products.

Approximately 30 countries in Europe, Asia, and North and South America currently (2018) permit farmers to grow hemp. Leading global hemp producers include Europe, China, South Korea, Russia, the United States and Canada. Some countries never outlawed production; other countries banned production for certain periods in the past and later lifted these restrictions. According to the Food and Agriculture Organization (FAO) of the United Nations data, Europe is the world's single largest hemp producing market. The EU has an active hemp market, with production in most member nations. Production is centred in France, the Netherlands, Lithuania, and Romania. Many EU countries lifted their bans on hemp production in the 1990s and, until recently, also subsidized the production of “flax and hemp” under the EU's Common Agricultural Policy. Other non-EU European countries with reported hemp production include Russia, Ukraine, and Switzerland. The FAO data also report hemp production in Chile, Colombia, China, Iran, Japan, South and North Korea, Pakistan, Russia, Syria, and Turkey. Other countries with active hemp grower and/or consumer markets not included in FAO's annual compilation are New Zealand, India, Egypt, South Africa, Thailand, Malawi, and Uruguay ([Johnson, 2018](#)).

On the other hand, it might well be possible for the textile industry to produce a satisfactory, even if limited, range of good quality hemp fabrics at reasonable prices. This would give flax spinners, particularly wet spinners, the advantage of being able to

produce a range of yarns based on a different fibre and aimed at a different market, which in turn should provide greater security.

China is currently the prime producer of hemp textiles and related products, as well as a major supplier to the United States, and other countries are now manufacturing them to a lesser extent. The United States remains the largest global importer of hemp products, which includes textiles from China, food and seed from Canada and industrials from Europe.

A small but growing market for hemp fabrics and garments is developing in Germany, the United Kingdom, Canada, United States and Australia. Demand is met by imports mainly from Hungary and China. The main selling points are novelty and hemp's environmental credentials. Garments currently available are a little heavy for their purpose and overpriced; these issues will need to be resolved if larger markets are tackled.

In December 2018, the federal Farm Bill in the United States removed hemp from the list of federally controlled substances, effectively making hemp legal to grow like any other agricultural crop.

"This is a monumental bill for hemp farming and gives hemp farmers access to banking, crop insurance and federal grants", said Lauren Stansbury, communications director for Vote Hemp, a national lobbying organization for hemp producers.

That open the industry, which produces therapeutic cannabidiol (CBD), fabrics, ropes to a wave of investment (Romero, 2018).

Just as iron ore is a primary product, and steel is a secondary product, seed and CBD outputs are strictly primary – while in hemp only the fibre is secondary.

Over the long run hemp fibre will become the most relevant part of the hemp plant, and the most valuable of its outputs.

However fibre will respond to changing market needs as a secondary "feedstock" product for many years because of the huge gap between the existing supply and demand in the marketplace.

Growing demand will cause growing supply – not lower prices. Of course, this does not mean that fibre prices will never go down. It is just that a supply/demand equilibrium won't happen for at least the next 20 years.

The fibre market will grow substantially over that time – bringing scale opportunities and financial success to the innovators. Whether from the perspective of a farmer, a large-scale decorticator, or a major end user of fibre, the hemp plant's fibre will end up being the long-term, dependable and most profitable output of the hemp industry.

As primary commodities, hemp seed and CBD outputs react swiftly to the reality of the world's quick changing market dynamics, driven by inevitable and often unpredictable pricing fluctuations (Ziner, 2019).

Meanwhile, in 2017 the total sales for the US Hemp Industry were US\$820 million among others for hemp-Derived CBD products - US\$190 million and consumer textiles – US\$105 million. The hemp industry was bolstered by explosive growth in the hemp-derived CBD category that grew from a market category that did not exist 5 years ago to \$190 mm in sales in 2017 (State of Hemp, 2017).

One estimate put the US CBD market at \$2.3–\$23 billion by the 2020s, enabled by the 2018 farm bill.

When the price of seed or CBD retreats, the fibre will always be there to stabilize the opportunity for the farmer. Even before the price of CBD falls in the future, farmers should look into the unique opportunity of growing hemp for fibre (Ziner, 2019).

Hemp fabric prices are currently high, in the range of £4–7/meter (150 cm width) wholesale (ex-works). Hemp will not be able to break into mass markets unless the price is lower than an equivalent linen fabric, at the same time as addressing quality control.

4.3.3 Statistics of flax production, including locations and production tonnages

In 2018, the world production of all fibres rose to approximately 111 million tons, a 1-year increase of four million tons, and a rise over the past decade of 35 million tons.

Of the world total, natural fibres accounted for 32 million tons of production during 2018, an increase of less than two million tons in 10 years. The share of natural fibres in world fibre production fell from 41% in 2008 to less than 30% in 2018.

Among the natural fibres, cotton production accounted for 26 million tons in 2018, hemp fibre and tow – 70,000 tons. Production of Jute, Kenaf and allied fibres fell to less than three million tons because of poor weather in the Ganges River Delta of India and Bangladesh (DNFI Steering Committee Meeting, 2019).

The farm value of natural fibre production in 2019 was around US\$ 51 billion. A reasonable estimate of total employment in natural fibre industries, including family labour, hired labour and employment in industries providing services to agriculture, and including both full time year round employment and part time or seasonal employment is around 60 million households or 290 million people, or about 4% of the world's population (DNFI Steering Committee Meeting, 2019; Townsend and Sette, 2016).

Global flax fibres and tow production quantity (tons) in the years 1961–2017 is show in Fig. 4.5 and in recent 7 years in Table 4.3 (T and <http://www.factf>)

In the last period of about 50 years, the production of flax fibres and tow is stable and did not exceed one million tons, except for the short period between 2002 and 2006, when China showed a huge demand for this raw material.

Top 10 countries in the world, flax fibres and tow production quantity (tons) in 2017 are presented in Table 4.4.

Five major countries producing flax fibres and tow in 2017 are show also in Fig. 4.6 (T and <http://www.factf>)

In 2017, as this table and Fig. 4.6 indicate, France producing 578,645 tonnes flax fibres and tow, making it the world's biggest producer followed by Belgium, Belarus and Russia.

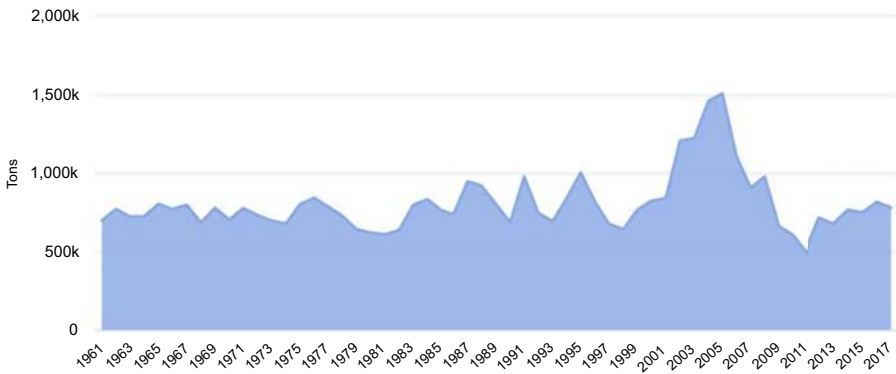

Figure 4.5 Global flax fibres and tow production quantity (tons) in the years 1961–2017 (T and <http://www.factf>).

Table 4.3 Global flax fibres and tow production quantity (tons) in recent 7 years (T and <http://www.factf>).

Year	Value
2017	780,554
2016	815,435
2015	749,418
2014	765,674
2013	678,214
2012	715,739
2011	486,634
2010	604,197

Table 4.4 Top 10 countries in the world, flax fibres and tow production quantity (tons) in 2017 (T and <http://www.factf>).

Country	Rank	Value as number
World		780,554
France	1	578,645
Belgium	2	69,341
Belarus	3	42,327
Russia	4	38,795
United Kingdom	5	12,452
China	6	12,140
Netherlands	7	10,224
Egypt	8	8123
Chile	9	3139
Argentina	10	2609

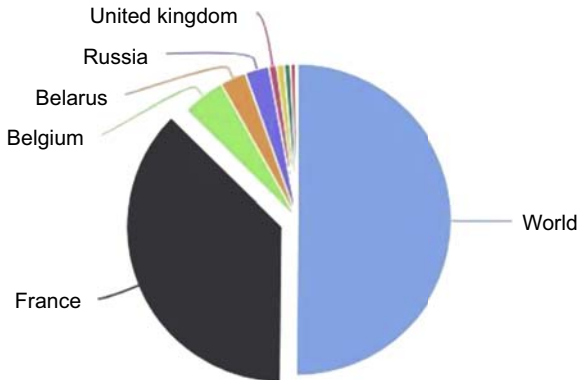

Figure 4.6 Five major countries producing flax fibres and tow in 2017 (T and <http://www.factf>).

4.4 Future trends and conclusions

To meet the demands of a new industrial market, fibre flax must preserve its image as a high quality natural product, grown traditionally. Industrial flax, however, must meet the challenges of excessively rigorous agricultural constraints and risks related to its cultivation and retting.

Pure, classic linen will always have a place in the fashion world (Fig. 4.7), but the development of new blends and finishes has expanded the market for linen fabrics.

Synthetic fibre blends can give good crease recovery, while blends with microfibers such as Tencel result in new textures. Linen/silk and linen/mohair are luxurious natural

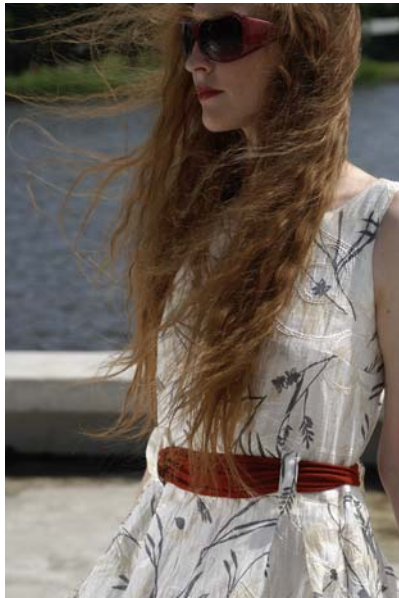

Figure 4.7 Linen collection from INF&MP.

Source: From the archive of INF&MP.

blends, while linen/wool is great as a trans-seasonal fabric. A range of finishing techniques can either crisp up or soften a linen fabric, depending on the desired end look, and new easy-care treatments make linen easy to launder at home.

Fabric finishing includes treatments such as bleaching, dyeing, coating, bonding, printing, texturizing and calendaring. These treatments can change the nature, feel, performance, look and texture of a fabric. New techniques can give the final fabric new properties and handles. Different finishing treatments can produce, for example, the crisp elegance of a fine damask tablecloth, or the cool comfort of linen sheets, and meet the demands of the fashion industry for new textures and performance. Recent developments in finishing include softwash and aero finishes for a relaxed look, and easy-care finishes, which cut down linen's creasability and allow the fabric to be fully washable and tumble-dry friendly ([Irish Linen Guild, 2010](#)).

New trends in flax fabrics: ([Borland, 2014](#))

France-based Safilin introduced in 2014 ultrafine linen yarns measuring up to 50 Nm. There is less twist in these fine yarns, and they are waxed after spinning and before winding.

Giemme and Mario Bellucci(Italy) are starting to develop fabrics using these ultra-fine linen yarns as sheer knits in blends with spandex.

Italy-based Marioboselli Jersey introduced new collections of linen/Lycra stretch knits and a Bio Line of 20 fabrics, all made using natural fibres, and dyed and processed using natural dyes and eco-friendly treatments. Linen mesh is popular.

Libeco Lagae S.A., Belgium, prepared extensive linen collections, pointing up the earth-friendliness of linen and hemp. Other fabrics include yarn-dyed crinkled crepes, double-sided colour-reverse washable linens, linen/metal blends, glitter-coated linens and chintz finishes.

Translucent mesh, foil prints and laminated linen denim are in production at John England Textile Ltd, Northern Ireland.

Further examples of innovations in the production of new types of linen fabrics are presented in [Table 4.5](#).

In addition to European innovation, China is also working on new solutions, mainly with hemp. China's Heilongjiang Province massively steps up its research and development efforts to make fine, environmentally friendly hemp fibres a large-scale alternative to cotton.

A comprehensive research programme involving universities from Heilongjiang Province and partners from the Ukraine and Canada, served to develop new, high-yield hemp varieties, to optimize combine harvesters for stalks and seeds and to introduce biotechnological procedures allowing for the production of fine hemp fibres in an environmentally friendly way using enzymes. Experts refer to this procedure as the enzymatic cottonization of hemp fibres, which may then be processed alone or together with other fibres by cotton machines ([Carus, 2017](#); [Batog et al., 2006](#)).

Very fine hemp fabrics already introduced to the market by 'Chinese Hemp Alliance' companies. The first bulk purchaser is the Chinese army, which buys hemp uniforms and socks for their soldiers ([Carus, 2017](#)).

In conclusion, attention should be paid to the trend of ecological consumerism, which has been extended to textile and clothing products. In recent times sustainability

is a leading characteristic of textile fashion products. Textile fashion companies are focussing more on sustainable products these days, so that they can meet the environmental and social aspects (Saravanan, 2015).

Relying on polluting textile materials like cotton and polyester may become a thing of the past as a new range of eco-fabrics emerge, often made from materials that would otherwise go to waste. Some of these environmentally friendly fabrics are already in use, like those made of coconut husks, recycled plastic bottles, wood pulp and corn, while others are strange and futuristic, sourced from hagfish slime, fermented wine, spoiled milk and genetically engineered bacteria (<http://www.teonline.com/a>, 2008).

Advances in biotechnology and enzymology have brought new lines of research and have accelerated the development of enzymatic applications in textile wet processing in the near future. Enzyme technology can be used to develop useable, more environmental friendly, economically competitive processes (Batog et al., 2006).

4.5 Sources of further information and advice

CELC – La Confédération Européenne du Lin et du Chanvre (European Confederation of Flax and Hemp) – <http://www.mastersoflinen.com> – is the agro-industrial European organization federating every stage of production and transformation of linen and hemp. Created in 1951, it comprises 10,000 member companies from 14 countries. Through the Textile Pole and the MASTERS OF LINEN brand, it promotes the European linen and hemp industries in the areas of clothing and art of living. Linen Dream Lab Paris and Milan are the CELC showrooms for expression, dedicated to creation and innovation for fabrics and techniques.

BE LINEN MOVIE: The first communication tool of the 3-year promotional program BE LINEN, co-financed by the European Union, the French government and the linen industry.

The FAO/SCORENA European Cooperative Research Network on Flax and other Bast Plants – <http://www.scorena.net> – is an umbrella organization for cooperation between research institutions focused on food, agriculture and related fields. It promotes research cooperation, exchange of information, and transfer of know-how and methodology advances, with clear sustainable development and socio-economic implications. The whole Network brings together 355 experts from 51 countries in the fields of research, economics, marketing and industry.

DNFI - DISCOVER NATURAL FIBRES INITIATIVE)- <http://dnfi.org/#about-a> platform for the natural fibres stakeholder community, to facilitate the exchange of knowledge and experience among members, to advance common interests.

Euroflax Newsletter – www.iwnirz.pl – contains reports from the Network's activity, articles on breeding, growing, processing of bast fibrous plants, use of natural fibres, reports from scientific events, calendar of events and statistical data (published twice a year in English).

The *Information Bulletin Euroflax Newsletter* – 32 issues since 1994 (200 printed copies) – reaches subscribers and Network members in 52 countries.

Table 4.5 Different types of linen fabrics and their producers in the European Union (<http://www.mastersoflinen>).

Type of linen fabric	Innovation, destination	Compositions	Weavers, knitters
DENIM	Renew classic denim through the use of linen yarns, crossed in typical white and blue, in a twill weave. Jeans, ready-to-wear	100% linen, linen/cotton, linen/elasthane, linen/silk, linen/wool	Deren, John England, Libeco-Lagae, Penta Servizi Tessili, Tessitura Monti
NON-WRINKLE FABRICS	Special finishing enable wrinkle reduction by 60%. Ready-to-wear		Seidra
STRETCH	Blend linen and elastomer; in yarn (core-spun); in weft-and-warp blend (mono-stretch). Ready-to-wear		
OUTDOOR	High-performance treatments: <ul style="list-style-type: none"> • water-repellent and/or waterproof • UV resistant • pool-and sea water resistant • mould resistant, • anti-bacterial 	100% lin, lin-PU, lin-PVC	End uses: <ul style="list-style-type: none"> • Fashion: • Albini, John England, Libeco- Lagae • Furniture & outdoor accessories: • deltracon, • Enrico Sironi, Libeco-Lagae, • Lemaitre-Demeestere, • Easy-care table linen; shower curtain: Libeco-Lagae
ECO-FINISHINGS	Low-impact dyes, accredited organic dyes, vegetable dyes, mechanical softening techniques, organic softeners, organic stonewashing with polished stones. The +: Colour, softness, equal performances, reduced environmental impact		Deltracon, Klasikine, Libeco-Lagae, Tessitura Monti

ECO-LABELS	Oekotex: Guarantee of non-toxicity and environmental + human criteria GOTS - global organic trade standard: Guarantee of organic fibre & eco-friendly transformation		LibecoLagae, Seidra, Vieböck, Albini, Deltracon, Eurtex, Lemaitre Demeestere, Libeco-Lagae, O.J.Van Maele, Pannonflax Textil, Rivolta Carmignani
DOUBLE FABRICS	Double weaves, bondings, two-tones, reversibles		Albini, Deltracon, John England, Klasikine, Libeco Lagae, Ormezzano, Tessitura Monti, Seidra, Solbiati
FLAME RESISTANT	Linens are made incombustible by a special treatment after weaving. Destination: Furniture, hotel decoration, public spaces The +: Ecological treatments are available that can be dry-cleaned		The first tests were made by Enrico Sironi and Solbiati. For more information: textile@mastersoffinen.com
WINTER FABRICS	Warm fabrics in linen blends or with brushed and mellow finishes Destination: Winter or mid-season ready-to-wear, accessories, throws, suiting ... The +: Linen's heat-regulating properties offer optimal comfort	100% linen, linen-wool, linen-cashmere, linen-alpaca,	Botto Giuseppe, Camillatex, Graziano, Inseta, Italtessil, John England, Klasikine, Libeco Lagae, Ormezzano, Penta, Seidra, Solbiati, Tessuti di Sondrio, Verilin
TAILORING	Collections specially destined for custom-made suits, in-stock deliveries		John England, Michele Solbiati
SHIRTING	Collections specially destined for custom-made shirts, in-stock deliveries		Albini, John England, Michele Solbiati

The *Journal of Natural Fibres* – <http://www.tandf.co.uk/journals/WJNF> – presents new achievements in basic research and the development of multi-purpose applications, which further the economical and ecological production of hard fibres, protein fibres, seed, bast, leaf and cellulosic fibres.

Other sources of information include

- ITL – Institut Technique du Lin (Institute of Flax Technology) – <http://www.lin-itl.com>
- CBLFTA – China Bast and Leaf Fibres Textile Association – www.chinalinen.cn
- The Irish Linen Guild – <http://www.irishlinen.com> – is the official promotional organization of the Irish linen industry. The main role is to promote Irish linen in national and international markets through the Guild website, and to provide a networking opportunity for members.
- IHA – International Hemp Association – www.internationalhempassociation.org – is dedicated to the advancement of hemp through the dissemination of information. Until 2009, the IHA published a peer-reviewed scientific journal entitled the *Journal of Industrial Hemp*.
- EIHA – European Industrial Hemp Association – <http://www.eiha.org> – is a not-for-profit association with the following objectives: to support the cultivation, processing and use of industrial hemp; to collect important information on industrial hemp and industrial hemp policy; to publish data about the European natural fibres industry; and to establish market figures and trends.
- HEMPTECH – The Hemp Information Network – <http://www.hemptech.com> – is a worldwide network of hemp professionals who are working to reintroduce industrial hemp. HEMPTECH publishes books and reports, as well as providing consulting and other information services to the growing hemp industry.
- Bastfibres, other, Fibre Crops not specified elsewhere, Hemp tow waste, Kapok, Ramie and Silk: <http://faostat3.fao.org/>
- ICAC – Cotton: International Cotton Advisory Committee www.ICAC.org
- IWTO – Wool and Other Natural Fibres, Animal Origin: International Wool Textile Organization www.IWTO.org

References

- Aishwarya Anand, A.S., Ramakrishnan, G., Srinivasan, J., Zakriya, M., 2018. Characterization of the raw hemp fibres for various properties for the development of Knitwear. *Colourage* 41–43. July 2018.
- Athane, S., 2009. ‘Safilin ouvre l’univers de la maille au lin’. In: *Journal de Textile*, No. 1992. Commercial Information: Safilin, France, p. 42.
- Batog, J., Konczewicz, W., Kozłowski, R., Muzyczek, M., Sedelnik, N., Tanska, B., 2006. Survey and recent report on enzymatic processing of bast fibres. *J. Nat. Fibers* 3 (2/3), 113–129.
- Borland, V.S., 2014. *Textile World Tracks New Developments at Textile Trade*.
- Bowerman, B., 2005. Oxidative stress and cancer: a β -catenin convergence. *Science* 308, 1119–1120.
- Carus, M., 2017. China Rediscovered Hemp, 10 August 2017. <http://news.bio-based.eu/china-rediscovered-hemp/>.
- Daenekindt, A., 2004. ‘Flax hemp and allied fibres in the world: flax and linen industry in China – present situation and perspectives’. *Euroflax Newsletter* 21 (1), 6–9.
- DNFI Steering Committee Meeting, 2019. posted on 22nd January 2019 by dnfi-secretariat. <http://dnfi.org>.

- Heller, K., The team of INF&MP, 2010. Non-food Crops-To-Industry Schemes in EU27, Progress Report of Project Crops2 Industry.
<http://hempalliance.org.au/>.
- Irish Linen Guild, 2010. What Is Linen? Available from: <http://www.irishlinen.co.uk/whatislinen/>. (Accessed 30 October 2010).
- Johnson, R., 2018. Hemp as an Agriculture Commodity. <https://www.fas.org/sgp/crs/misc/RL32725.pdf>. (Accessed 22 June 2018).
- Jones, J.K., 2009. Annual General Meeting of Shareholders – NAT (Naturally Advanced Technologies), vol. 5. August 2009.
- Kati, R., 2002–2004. ‘Report from the Republic of Hungary’, IENICA INFORRM Project. Department of Agricultural Chemical Technology, University of Technology and Economics, Budapest.
- Kft H.L. Available from: <http://www.hungarolen.hu>. (Accessed 4 May 2010).
- Kozlowski, R., Manys, S., 1999. Green fibres. In: Proceedings of the 79th World Conference of the Textile Institute, Chennai, India.
- Kozlowski, R., Kicińska-Jakubowska, A., Muzyczek, M., 2009. Natural fibres for interior textiles. In: Rowe, T. (Ed.), *Interior Textiles: Design and Developments*. Woodhead Publishing, Cambridge (Chapter 1).
<http://www.mastersoffinen.com>.
- Muzyczek, M., 2000. Natural fibres in clothing viewed against the background of globalisation and as response to new challenges of the 21st century. In: Proceedings of the Third International Symposium on Natural Polymers and Composites – ISNaPol/2000, San Pedro, Brazil.
- Muzyczek, M., Kozlowski, R., 2004. ‘Industrial Softening of Hemp Apparel Fabrics by Enzymatic Treatment’, COST 847 Meetings WG2 and WG3, Maribor, Slovenia.
- Riddlestone, S., Franck, B., Wright, J., 1996. *Hemp for textiles: growing our own clothes*. Sutton ecology centre, bioregional development group. In: Desai, P. (Ed.), *The Apparel Trust, Bioregional Development Group*, Carshalton, Surrey, UK.
- Romero, D., 2018. Hemp Industry Expected to Blossom under New Farm Bill. NBC News. December 16, 2018.
- Saravanan, M., 2015. Eco friendly textiles’. *Colourage* January 29–32.
- State of Hemp Report : 2014-2022 , Hemp Business Journal, 2017. www.hempbizjournal.com/size-of-us-hemp-industry.
<http://www.teonline.com/articles/2008/11/herbal-textile-theeco-friendl.html>.
- Townsend, T., Sette, J., 2016. Natural fibres: advances in science and technology towards industrial applications. In: Proceedings from Conference Natural Fibres and the World Economy, vol. 11, pp. 381–390. February 2016.
- FAOSTAT, <http://www.factfish.com/statistic>.
- UK Cannabis Internet Activist (UKCIA), 2010. Hemp Textiles in Britain. Available from: <http://www.ukcia.org/industrial/hemptextilesinbritain.php>. (Accessed 30 October 2010).
- Ulrich, D., March 2007. Emerging Markets: Growing the Cotton Business. *Cotton International Magazine*.
- Zhang, J., 2008. Natural fibres in China. In: Proceedings of the Symposium on Natural Fibres, Rome.
- Zimniewska, M., Kozlowski, R., Muzyczek, M., Florysiak, M., 2004a. In: Towards more physiological friendly apparels Made of naturals ‘bast fibrous plants for healthy life’. Institute of Natural Fibres, Poznan, Poland. Banja Luka.
- Zimniewska, M., Kozlowski, R., Pawluk, M., 2004b. Natural vs. Man made fibres- physiological viewpoint. *J. Nat. Fibers* 1 (2), 69–81. Shows, *Textile World Magazine*, GA May/June 2014.
- Ziner, R., 2019. For long-term value from the hemp plant, look to the fibre’. *HempToday™* 1–2. March 7, 2019.

This page intentionally left blank

Use of bast fibres including flax fibres for high challenge technical textile applications. Extraction, preparation and requirements for the manufacturing of composite reinforcement fabrics and for geotextiles

Pierre Ouagne¹, Damien Soulat², Philippe Evon³, Sullivan Renouard⁴, Manuela Ferreira², Laurent Labonne³, Ahmad Rashed Labanieh², Eric Laine⁵, Emmanuel De Luycker¹

¹ENIT, LGP, EA 1905, Tarbes Cedex, France; ²University of Lille, GEMTEX, ENSAIT, Roubaix, France; ³Laboratoire de Chimie Agro-industrielle (LCA), Université de Toulouse, INRA, INPT, Toulouse, France; ⁴University Orléans, LBLGC EA1207, Antenne scientifique de Chartres, Chartres, France; ⁵Institut de Chimie et de Biologie des Membranes et des nano-objets, CNRS UMR 5248, Bordeaux University, Pessac, France

5.1 Introduction

Natural fibres such as flax have long been considered as potential reinforcing materials or fillers in thermoplastic or thermoset composites. Numerous studies deal with the subject (La Mantia and Morreale, 2011; Satyanarayana et al., 2009; Biagiotti et al., 2004; Puglia et al., 2005; Pandey et al., 2010; Ouagne et al., 2010a). Natural fibres are particularly interesting because they are renewable, have low density and exhibit high specific mechanical properties. They also show non-abrasiveness during processing, and more importantly biodegradability. A large amount of work has been devoted to identify the tensile behaviour of individual fibres or group of few fibres of different nature and origin (Baley, 2002; Bodros and Baley, 2008; Alawar et al., 2009; Kim and Netravili, 2010) to prove their interest in technical applications such as load bearing composites or geotextiles.

However, in a lot of these studies, the fibres are often extracted manually and in the frame of industrial applications, the impact of fibre extraction processes is not always taken into account. It is therefore important to investigate the different stages and their impact on the mechanical and morphological properties from different processes that can be used.

To manufacture composite parts, one can decide to use non-woven structures as a reinforcement if the application does not need to resist to high loads. If high load bearing applications are targeted, it is necessary to organise and to align the fibres. As a consequence, aligned fibres architectures such as unidirectional sheets, non-crimped fabrics and woven fabrics (bidirectional) are usually used as reinforcement. This work proposes to briefly review the different textile techniques used to manufacture from vegetal fibres non-woven structures, yarns and architecture fabrics (woven, braided).

In the Liquid Composite Moulding (LCM) family, the Resin Transfer Moulding, (RTM) process has received a large attention in the literature (Buntain and Bickerton, 2007) and particularly the second stage of the process dealing with the injection of resin in preformed dry shapes and the permeability of the reinforcements (Lekakou et al., 1996; Ouagne and Bréard, 2010). However, few studies deal with the subject of the mechanical behaviour (particularly the deformability) of fibre assemblies dedicated to technical applications and particularly to reinforcement applications such as composite materials or soil reinforcement. The first stage of this process consists in forming dry reinforcements. In case of specific double curved shapes, woven fabrics are generally used to allow in plane strain necessary for forming without dissociation of the tows.

The modification of the tow orientation and local variations of fibre volume fraction have a significant impact on the resin impregnation step as the local permeabilities (in-plane and transverse) of the reinforcement may be affected (Hammani et al., 1996; Loix et al., 2008). In the most severe cases, the ply of fabric can wrinkle or lose contact with the mould, hence severely reducing the quality of the finished product (Sharma et al., 2003). Another defect called tow buckling has also been reported for flax woven fabrics (Ouagne et al., 2010b, 2011a, 2012a). As the quality of the preform is of vital importance for the final properties of the composite parts, it is important when forming of complex shape is considered to prevent the appearance of such defects. Several experimental devices have been set up to investigate the deformation modes and the possible occurrence of defects during forming of textile reinforcements. Hemispherical punch and die systems were particularly studied because the shape is rather simple, it is doubled curved and because it leads to large shear angles between the tows (Molnar et al., 2007; Li and Bai, 2009; Vanclooster and Lomov, 2009). Solutions to prevent defects were also studied and proposed so that to form complex shapes from reinforcement textiles (non-wovens and architected woven and braided structures).

Geotextiles are another families of technical textiles that can be manufacture from vegetal fibres such as flax. These products still under development should not use the long fibres used to manufacture the fine flax fabrics for clothes, or the long fibres used to manufacture load bearing composite materials. Instead of this, the flax tows which are by-products of the textile flax industry, or the fibres extracted from the linseed flax straw which is mainly not valued could be used advantageously after classical textile architecturation into widely open woven or knitted structures and after a preparation to confer the fibres a good resistance to bacterial and fungi attacks during their service life before disappearing after bio-degradation.

5.2 Impact of extraction and preparation of flax fibres for technical applications for differently harvested stems

In most of the scientific papers or reviews dealing with the subject of flax used for technical textiles for load bearing applications, the considered fibres are generally coming from textile flax cultivated for their fibres and extracted from classical scutching combing and preparation units initially used for the textile industry (for clothes purposes). The cultivation of flax and the techniques associated are well documented and were deeply reviewed in numerous papers or book chapters from which it is possible to cite the contributions of Salmon Minotte (FlaxFranck, 2005), and Mussig and Haag (2015). In the same references, the fibre extraction techniques are also well described.

At the present time, the flax marked price is high and the textile industry (for clothes purposes) can absorb the totality of the production of long scutched fibres. It would therefore be interesting to consider other sources of fibres for the technical applications that do not necessarily require the use of the long scutched fibres from textile flax. An alternative to the textile flax long fibres are the textile flax tows also already described as a possible source of fibres for composite applications by Martin et al. (2014). Another alternative is the use of linseed flax fibres extracted from randomly aligned straws that are generally not valued or valued with low added value.

5.2.1 Randomly orientated flax stems (linseed flax): all fibre extraction

Oleaginous flax is cultivated primarily for its seeds which can contain up to 45% of vegetal oil. It is an important vegetal source of omega-3 and omega-6 fatty acids, and it is therefore widely recommended for human consumption. Secondly, thanks to its nourishing properties, linseed oil is also used for the formulation of many cosmetic products. Lastly, linseed oil is a drying oil which spontaneously cures in air. It is therefore frequently used as a siccative for vegetable inks, as well as in the formulation of oil paints, floor cleaners and wood preservatives. Beyond this the straws contain fibres that were shown to possess mechanical properties that can be before extraction from the stems equivalent to the ones of the textile flax (Pillin et al., 2011). In a study published in 2011 by the French National Environment Agency (ADEME) (ADEME Report, 2011), it appears that 11,000 ha of oleaginous flax are cultivated in France each year. This is a small fraction of the worldwide production which was identified in 2009 to be of about 1.7 Mha from which Canada is the main producer with 650,000 ha. The amount of straw is generally considered to be about 2 tons/ha for oleaginous flax. However, it has to be mentioned here that the size of the flax stem is prevented to grow so that to avoid falls of the plant in the field, thus associated to troubles for the harvesting. In their study reporting the influence of the genotype of 11 varieties, Rennebaum et al. (2002) showed that up to 5.5 t/ha of straw can be harvested without compromising the amount of seeds. If seeds of oleaginous flax are well valued, the rest of the plant, and particularly the straw, is most of the

time not used at all. It is shredded simultaneously during the seed harvesting. This explains mainly why technical textiles from oleaginous flax are not available on the market even if the mechanical properties of the linseed individual fibres reported in relatively few studies (Rennebaum et al., 2002; Tomljenovic and Erceg, 2016) indicate that they are situated in the lower range of the textile flax fibre mechanical properties.

The harvesting of oleaginous flax does not allow the straw to be processed with the same techniques than the ones used for textile flax. The straws are mown and directly absorbed by the combine harvesting machine which separates the seeds from the straws with its integrated threshers. The straws are therefore submitted to mechanical loadings during the beating phase. At the end of the threshing phase, the straws fall regularly from the combine harvesting machine and form a windrow of randomly oriented stems. The straws can then be left in the field so that a dew-retting performed by soil microorganisms can take place. This pre-processing stage, which is well known and documented for textile flax cannot be performed with the same protocol for linseed flax as the straws are not aligned and well distributed on the ground. During the dew-retting, the contact with the soil and therefore the microorganisms are not similar for all the pieces of straws. Even if it would be possible to return the windrow during time, the evenness of the dew-retting may be questionable. Moreover, as the fibres are not aligned within the windrow, the linseed flax stems are packed with random orientations in large balls each of about 200 kg, and the stems cannot be aligned as it is the case in the traditional scutching and hackling route usually employed to separate the different vegetal fractions of the plant for the textile flax. As a consequence, an “all fibre” device has to be used. Different devices, inspired from the paper industry are generally used. However, these devices are often very aggressive to the fibres, and they may lead to the appearance of defects such as dislocations within the fibres as it is the case during the extraction of hemp fibres (Hernandez-Estrada et al., 2016).

It is proposed here to study the potential of linseed flax fibres after extraction using a “all fibre” extraction device, supposedly less aggressive than the hammer mills used in the hemp industry. A Laroche (France) Cadette 1000 “All Fibre” extraction equipment was used to separate the different vegetal fractions from all the oleaginous flax straw batches considered in this work. A schematic diagram of the device is presented in Fig. 5.1.

With a 1 m width, this tearing machine has the capacity to both perform the opening and the cleaning of natural fibres, as well as the realization of laps. It is equipped with three modules. At the inlet of each of them, the feeding of the raw material is ensured by a pair of rollers, one smooth and the other grooved (made of rubber). Then, each module has a cylinder equipped with nails, i.e., the extracting roller (or fibre extraction roller). Its rotation speed is adjustable (from 750 to 1800 rpm). Under the extracting roller, a trap door allows the flax shives to be evacuated by gravity. This device is capable to process 175 kg of randomly aligned straw per hour. Of course, this value depends on the size of the equipment. This one is a middle size equipment having a 1 m wide belt. Larger equipment exists for industrial production applications. The straw used in this study was balled dry after a moderate dew retting.

At the end of each module, there is also a perforated cylinder at which ventilation is applied. The perforated cylinder has three functions: extracting the vegetal dust from

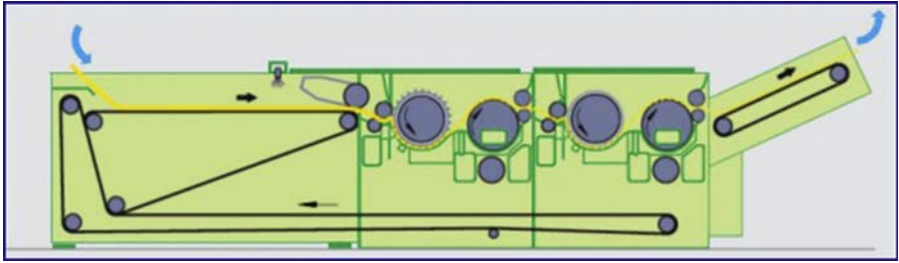

Figure 5.1 Laroche (France) Cadette 1000 fibre extraction device. From Laroche company website.

the material, forming the lap, and transferring it to the next module or the outlet. Each de-dusting fan is equipped with a motor with a maximum rotation speed of 2865 rpm.

At the end of the processing procedure randomly aligned linseed flax fibres can be obtained in the form of a fibre lap as shown in Fig. 5.2.

Then, the residual flax shives still trapped were collected manually. Fig. 5.2 shows photographs of the three obtained vegetal fractions.

The proportion of fibres extracted from the oleaginous flax stems (deseeded) was found to be in the range [38%–40%] which is very much larger than what was reported in the very few studies found in the literature. In a study from the French National Environment Agency (ADEME) (ADEME Report, 2011), the respective amounts of fibre, shives and dust were 25%, 65% and 10%. In their study, Rennebaum et al. (2002) found an average fibre yield of 23% for 11 different varieties with a peak value at 29%. Our results therefore show that a greater proportion of fibres are extracted, in combination with an equivalent amount of shives. The lap at the time of the fibre proportion evaluation were very cleaned following a sieving and final shive



Figure 5.2 Linseed flax fibre lap after all the extraction operations.

extractions procedures. One can argue here that some fibres in the other studies may be lost during the extraction, and that some of them may also be transformed into a larger proportion in vegetal dusts. The global amount of fibre extracted from the oleaginous stems is comparable to the percentage of fibre extracted from textile flax (i.e., 25% of long fibres plus 15% of short fibres (tows), corresponding to a 40% total amount of fibres) (ADEME Report, 2011).

The results presented (Ouagne et al., 2017a) indicate that the relative percentage of fibres that can be extracted from oleaginous flax is much higher than for the previous studies. This large proportion of fibre could increase the economic interest of harvesting the flax stems instead of shredding them during the seed harvesting.

Morphological properties of linseed flax were also investigated in the frame of the extraction performed with the Laroche Cadette 1000 “all fibre extraction device”. The mean fibre length of the extracted technical fibres is on average equal to 5.3 ± 2.9 mm. The extraction procedure has therefore for consequence to drastically reduce the length of the technical fibres as the rotating cylinders equipped with the teeth are still quite aggressive. This length of fibre is still however convenient for different textile preparations including some of the different spinning techniques and particularly the ones where thermoplastic fibres can be mixed with the linseed flax fibres (Part 3 of this paper).

The impact of the extraction process on the mechanical properties of the individual linseed flax fibres is presented in Table 5.1.

The results presented in Table 5.1 show that the “all fibre extraction” has a significant impact (tested by a statistical Student t-test) on both the tensile strength. It is not significant on the tensile modulus even though one can observe a decrease. The decrease of about 45% of the tensile strength is probably due to damages conferred to the fibres during the extraction procedure that act as zones of weakness and favoured zones for crack initiation. These defects are on the contrary less impactful on the tensile modulus. The values of the tensile properties of the tested linseed flax are much higher than the values reported in the literature by Remebaum et al. (2002). This is probably due to the fact that the fibre extraction technique used in their study was probably more aggressive than the Laroche Cadette 1000 used in this study. The values of the individual fibres tensile properties, even if they are much lower than the ones measured on fibres manually extracted are still within a range of properties acceptable for semi-structural composite materials or for a geotextile use. It is therefore possible to conclude in favour of the use of linseed flax fibres extracted with a “all fibre” device such as the Laroche Cadette 1000 for semi-structural applications. However, even if it

Table 5.1 Tensile properties of linseed flax fibres after “all fibre”.

	Tensile strength (MPa)	Tensile modulus (GPa)
Manual extraction	1110 ± 707	46 ± 29
All fibre extraction	606 ± 415	39 ± 20
Remebaum et al. [ref]	445	—

is possible to consider linseed flax fibres in semi-structural reinforcement applications, the potential of linseed flax is not completely used. As a consequence, it would be good to optimise the all fibre extraction technique presented in Fig. 5.1 or to design a set of apparatus that would be still convenient for the extraction of randomly aligned straws but less damaging for the fibres.

5.2.2 *Aligned stems: scutching and hackling*

Traditionnally, the cultivation of textile flax in Normandy (France) or Belgium is associated to dew retted and the retted straws are then processed in extraction plants that consist as described by Salmon-Minotte (FlaxFranck, 2005) and Mussig and Haag (2015) as a serie of breaking rollers to break the ligneous part of the stems without breaking the fibres. As the stems are retted, the link between the ligneous part of the stem (shives) is degraded and the broken woody part can be separated from the bast fibres by using a beating stage called scutching. This process is perfectly well industrialised and used by specialised companies in direct link with farmers. The quality of the fibres extracted using such devices is generally accessed by the degree of fineness of the fibres and its softness which are crucial point when considering these fibres for high added values textiles for the luxury clothe industry. The mechanical property aspect is not the essential point. On the contrary, for composite materials it is important to maximise the properties of the reinforcement fibres. Most of the reinforcement textiles proposed for the reinforcement of composite materials are manufactured from textile flax processed in equipments dedicated to the clothe industry. The impact of the different processing steps on the mechanical properties of technical or individual fibres is not very well reported in the open literature. In a preliminary study a laboratory scutching device presented in Fig. 5.3 was used to study the impact of scutching and hackling on the tensile properties of individual textile flax fibres. This device can process both un-retted and retted aligned straws. In the case of textile



Figure 5.3 Laboratory scutching and hackling device from TAP-ROOT FIBRE LAB (ENI of Tarbes-France).

flax, the straws are well due retted so that to ease the extraction and favour thinner technical fibres. In the case of linned flax, the fibres are generally less retted.

The results of the influence of the breaking, scutching and hackling steps are reported in [Table 5.2](#).

The analysis performed on textile flax samples shows that the different extraction parts of the device do not significantly (Student's test performed) impact the tensile strength of the single fibres. However, hackling has a negative effect on the tensile modulus of the individual fibres but it improves the fineness of the fibres (by a factor three at least) and this is particularly important at the composite scale because using coarse fibres with poor fineness has for tendency to reduce the tensile strength of part. The decrease of the modulus could be linked to an increase in the number of defects (kink bands) observed at the surface of the fibres.

This study shows that a scutching/hackling device can be advantageously used to extract long fibre technical fibres for composite reinforcement from well dew retted flax straws. It is however very important to pay attention to the severity of the hackling as this process step may have for tendency to reduce the value of the fibre rigidity and therefore a compromise needs to be found because hackling favours a good separation of the fibres and removes the lasts pieces of bark that could be places of weakness at the composite scale ([Derbali et al., 2018](#)).

5.3 Composite reinforcement textiles: use of processes that can maximise the mechanical and the deformability of textile reinforcement structures

To manufacture structural composite parts, long aligned and continuous fibre reinforcements are used, as shown by numerous applications based on E-glass or carbon raw material. With these synthetic materials, yarns are constituted of a large number of multifilament, highly aligned with no (or low) twist. From these yarns, fabrics can be manufactured by classical textile technologies. Due to the high added value of the applications in which composite parts can be encountered, low production speeds can be accepted, to limit or prevent the appearance of manufacturing defects and

Table 5.2 Tensile properties of single flax fibres: Batch 1: manually extracted; Batch 2: After crushing on the machine rollers; Batch 3: After Crushing and scutching with the machine; Batch 4: After crushing, scutching and hackling with the machine; Batch 5: After crushing, scutching, hackling and a supplementary manual hackling.

	Batch 1	Batch 2	Batch 3	Batch 4	Batch 5
Strength (MPa)	1240 ± 515	1341 ± 637	1393 ± 460	1198 ± 502	1292 ± 376
Modulus (GPa)	61 ± 19	54 ± 16	56 ± 18	47 ± 21	44 ± 13

material losses on these twist-less yarns which tend to fibrillate during the preform manufacturing, as illustrated on Fig. 5.4 (Decrette et al., 2016; Turlonias and Bueno, 2016).

On the contrary, for lower added value textiles (clothing), the use of yarns with lower linear density, strongly twisted (Ramachandran et al., 2009), if it is not doubly twisted, allows higher manufacturing production rates (higher weaving speeds for example) to be achieved, and fabrics without defects, but with performance that is sufficient for these applications. Particularly, these yarns are not designed to be impregnated by a resin as in the case of composite reinforcements. Manufacturing optimised composite reinforcements for load bearing applications requires the optimisation of several manufacturing steps, which may be challenging as the goal consists of manufacturing preforms as well-aligned as possible from yarns composed of fibres of finite and highly variable length. Yarns also need to be highly permeable to ensure a good penetration of the resin between the fibres or bundles, which is a significant challenge.

With these objectives, we will dissociate in this section the technologies associated with non-woven products from those concerning the alignment of fibres that require the manufacturing of yarns. The deformability of these preforms will be also addressed, especially during the first step of the LCM process, the preforming stage of dry preform.

5.3.1 A. non-woven reinforcement for composites

Although researchers have recently focused on highly aligned plant fibre-reinforcement structures (Baghaei et al., 2013; Goutianos et al., 2006; Shah et al., 2016; Shah, 2016) for the manufacture of load-bearing composites components, Shah (2014) has used an Ashby approach to show that non-woven fabrics can be

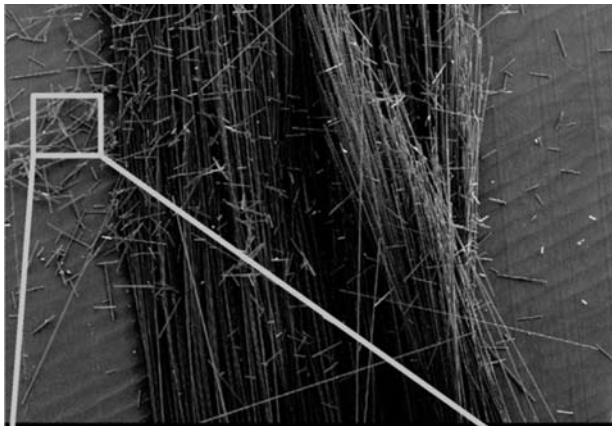

Figure 5.4 Defects during the weaving process: broken carbon monofilament (Turlonias and Bueno, 2016).

very attractive in terms of tensile properties per unit cost. Non-woven fabrics or mats are the most common form of reinforcement used in natural-fibre composites (Xue et al., 2011) due to the costs involved and also to their ability to combine a good acoustic absorption with higher mechanical properties (Merotte et al., 2016) in only one product, compared with loose fibres. Thanks to these properties, non-woven bio-composites are becoming a major asset to the automotive industry for a variety of applications. This is due to their light weight, sound efficiency, flexibility, versatility and easily tailored properties, together with low process and materials costs and an attractive cost/performance ratio.

5.3.1.1 *Manufacturing processes of non-woven reinforcements*

Das et al. (2012, 2014) have described several technologies to manufacture non-woven fabrics, defined (INDA) as sheet or web structures bonded together by entangling fibres (and by perforating films) mechanically, thermally or chemically. Short fibres extracted from flax straw have great variations in length and linear density and are the main raw material of non-woven reinforcements. They may have high dust content and are either smooth or stiff. Some pieces of shives may also remain but this should be avoided. They have relatively little cohesion when formed into a web in contrast to fibres such as wool or cotton for example. Webs are formed either mechanically by carding or aerodynamically. Bonding of webs can be achieved by water jet, needle punching, stitch bonding, adhesive bonding, etc (Mosca, 1986; Boettcher and Schmalz, 1993; Maity et al., 2014). The needle-punching method is probably the most suitable method for producing thick non-wovens from flax fibres. The retted, scutched or opened, flax fibres can be used without any chemical treatment. The flax fibres are then carded to form a thin web. The carded web is then made into a thicker batt by the cross-laying or parallel-laying methods. This fibre batt is then consolidated on a needle-punching machine to form the final flax non-woven mat (Mosca, 1986; Boettcher and Schmalz, 1993; Maity et al., 2014) as shown by Fig. 5.5. Hybrid non-woven composites have been prepared by researchers by using blends of synthetic fibres, which provided a good basis for high product quality. By mixing the two composite components before the consolidation, a proportional distribution and a good wetting of the reinforcing fibres can be ensured. Short fibre reinforced and non-woven flax/PP blend composites were prepared by carding and needle punching and analyzed in (Merotte et al., 2016; Moryganov et al., 2008; Eco-technilin; Merotte et al., 2018; Gnaba et al., 2018).

5.3.1.2 *Mechanical properties of flax non-woven fabrics*

Physical properties such as surface mass, density, and thickness play an important role for different potential applications of non-woven materials. Ultimately, these characteristics govern many functional properties of non-wovens such as thermal and noise insulation, water absorbance, resilience, compressibility, filtration, etc. So, we should have knowledge of the processes which are suitable for obtaining a given level of surface mass, density and thickness of non-wovens. The most important characteristic of



Figure 5.5 Sample of flax non-woven fabrics (areal density of 330 g/m^2) (Omrani, 2017).

all non-woven materials is the tensile strength. The tensile properties of needle-punched non-woven fabrics are influenced by the fabric structural parameters, such as the fabric density, the amount, and depth of fibre entanglement resulting from the fabric formation process and fibre properties (Maity et al., 2014). The increase of the tensile strength as a function of the areal density of needle-punched flax non-woven was shown by Anandjiwala and Boguslavsky (2008) and Gnaba et al. (2018). The tensile properties of non-woven fabrics are different in both directions of the fabric due to structural anisotropy resulting from the process of fabric formation. The practice of producing non-wovens, by web formation and cross-lapping, results in different strengths in the machine direction (MD) and cross directions (CDs), respectively. Fages et al. (2011) have studied the tensile properties of flax/PP blend needle-punched heat bonded fabric and they showed that when the proportion of PP fibre increased, the tensile strength increased in the MD and elongation increased. The tensile properties are mainly influenced by needle-punching parameters (depth of needle-punching and needle-punching density). Gnaba et al. (2018) have recently demonstrated for Flax/PP non-woven that an increase of the maximum tensile strain can be related to the increase in the needle-punching density. In addition, increasing the needle-punching density leads to a decrease of the anisotropy ratio of the tensile behaviour between the MD and the CD.

5.3.1.3 Formability potential of flax-nonwoven fabrics

The high deformation potential of the non-woven fabrics can be an advantage for the preforming step and especially for the deformability. Associated to the global mechanical responses, local analyses were performed on samples where local zones were marked to measure the evolution of their surfaces during the tensile tests (Omrani et al., 2017a). This study has shown that the flax non-woven fabrics do not deform homogeneously. Consequent variation of area density in each local zone during the tensile tests may be observed (Figure 5.6). The deformability of non-woven reinforcements during the preforming step was not studied on the contrary to the resin flow



Figure 5.6 Hemispherical and square shapes preforming of Flax/PP non-woven fabrics. Homogeneity defects by loss of density (Omrani et al., 2017a).

characteristics (permeability) of non-woven during the injection step (Xue et al., 2011, Zhang et al., 2012, Xue and Miao, 2012). Criteria to define the formability of fabrics were established for aligned reinforcements, such as the locking angle (Boisse et al., 2011, Prodromou and Chen 1997) for the in-plane shear behaviour. Resulting of their manufacturing processes without a yarn spinning step criteria characterizing the deformability of non-wovens during the preforming stage cannot be the same to the ones of highly aligned reinforcements. As shown on figure 5.7, experimental preforming tests with non-woven of 300g/m^2 and 450g/m^2 were described in Omrani et al. (2017a) with hemispherical and square shapes. With hemispherical shape, these first results have shown that draw-in obtained is very weak, depending on the blank-holder pressure and the areal density, and that the deformability of non-woven fabrics is characterized by a slippage of fibres, which was estimated by measurement of area density in each local zone of the preform. With an increasing blank-holder pressure, the preforming of lightest non-woven fabrics can lead to defects as zones with very low fibre density. With square box punch, resulting in higher preforming load, the damage of the non-woven preform can be obtained. Additional preforming tests with both punch shapes were realized with heavier flax non-woven fabric of 600g/m^2 . Final shapes are presented on Fig. 5.7. With hemispherical punch, draw-in, depending on initial orientation of the blank (MD/CD), remains very weak and no defects appear. Markers applied on preform are useful to measure local area density. With square box punch, significant draw-in can be obtained; preforming loads applied are more important and allow having tension deformation. Thanks to markers, for example, on lateral surfaces of the preform, local orientation of fibrous material can be followed during the preforming test.

Additional preforming tests with both punch shapes were realized with heavier flax nonwoven fabric of 600g/m^2 . Final shapes are presented on Fig. 5.7. With hemispherical punch, draw-in, depending on initial orientation of the blank (MD/CD), remains very weak and no defects appear. Markers applied on preform are useful to measure local area density. With square box punch, significant draw-in can be obtained; preforming loads applied are more important and allows having tension deformation. Thanks to markers, for example on lateral surfaces of the preform, local orientation of fibrous material can be followed during the preforming test.

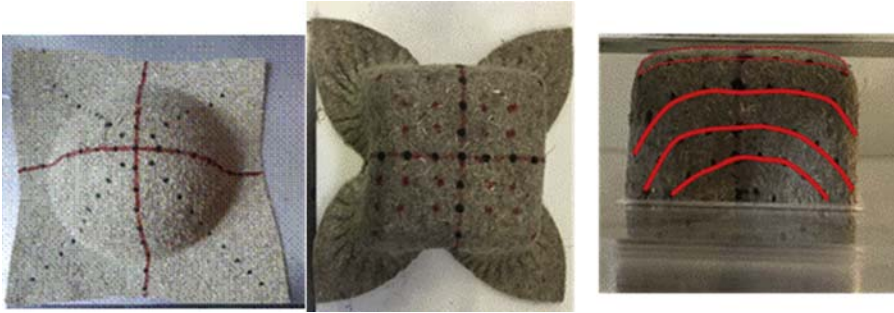

Figure 5.7 Hemispherical and square shapes preforming of Flax/PP non-woven fabric of 600g/m^2 . Draw-in and evolutions of local fibers orientation.

5.3.2 *Manufacture of woven fabrics for composites*

5.3.2.1 *Manufacture of different families of yarns*

Yarn strength is the main property for yarn quality evaluation. Sufficient yarn strength is necessary to manufacture fabrics by weaving or braiding. For natural fibre yarns with too many short fibres with a low (or null) twist level, the tensile failure mechanism of the yarn is dominated by fibre slippage (Zhang and Miao, 2010; Jiang et al., 2017). Many studies have been performed (Hearle et al., 1969; Pan, 1992, 1993a, 1993b, 1993c; Frydrych, 1992; Pan et al., 2001; Gregory, 1953) to improve the understanding of yarn failure. Parameters at the fibre scale such as the length, distribution of fibres lengths in yarns, and fibre linear density have received particular attention. It is well known that when yarn breaks, fibres may also break or slip in the yarn breaking section. This depends on the critical slipping length of the fibres (Gregory, 1953; Jiang et al., 2014; Yan and Yu, 2007). These studies, essentially performed by mechanical modelling (Hearle et al., 1969; Pan, 1992, 1993b; Frydrych, 1992, 1995), do not take into account any twist, and assume that all the constituent fibres are completely straight and parallel to the yarn axis. Without a strong cohesion between these staple fibre bundles, slipping occurs and the yarn strength remains low. The variability of tensile properties without a real cohesion between fibres is very high, as shown in (Omrani et al., 2017b; Belaadi et al., 2016; Blanchard et al., 2016). In this section, three technologies to increase this cohesion are described: twisting by using conventional ring spinning; addition of a binding agent and cohesion by wrapping/comingling/or micro-braiding.

- Twisted yarns

Spinning is the process that is the most commonly used to produce continuous twisted yarns of a desired size from fibrous materials. Long and short staple spinning can be distinguished. Short staple spinning machine processes fibres such as natural fibre (Kumar and Das, 2017). An extensive range of spinning techniques were developed during the twentieth century and their classification was described in (Lawrence, 2010). At a high twist level, fibre slippage in the yarn is prevented by the high

frictional force between the fibres. In this case, the yarn failure is mainly due to fibre breakage. Yarns are characterized by the direction of twist (S or Z-directions), by the twist level (expressed in turns by meter (TPM) or with the twist angle), and by their linear density. The level of fibre alignment as a function of twist level can be estimated by the Krenchel fibre orientation factor (Shah et al., 2013a; Gu and Miao, 2014). Clearly, the fibre alignment in a single yarn reduces when the yarn twist increases, as shown by Gu and Miao (2014). Yarns manufactured from short fibres do not have adequate strength for handling unless a sufficient level of twist is applied. The twist required for achieving sufficient yarn strength for processing determines the level of fibre alignment of the single yarns. The influence of twist level on the strength of natural fibre yarns was studied by several authors (Fig. 5.8) (identified at the dry scale) but also on the strength of composites manufactured from these yarns. At the scale of the composite the influence of twist has for effect to decrease the tensile strength as described in (Goutianos and Peijs, 2003; Baets et al., 2014; Bensadoun et al., 2015; Bensadoun, 2016). However, it is very difficult to dissociate the influence of twist level during the process of impregnation (for example on the permeability) and the influence on composites characteristics. At the dry scale, on flax yarns of 210 tex, Goutianos and Peijs (2003) showed that very low twisted yarns exhibit a very low strength. Ma et al. (2014) have studied the effect of different twist levels (20, 60 and 150 turns per meter, tpm) on the tensile strength of un-impregnated sisal yarns (with a linear density of 1250 tex) which first increased and then started to decrease when a critical twist level (90 tpm) was reached.

The effect of twist on the yarn tensile strength was also described by Shah in (Shah et al., 2013b), results from an analytical model were compared with experimental data given by Goutianos and Baets (Goutianos and Peijs, 2003; Baets et al., 2014).

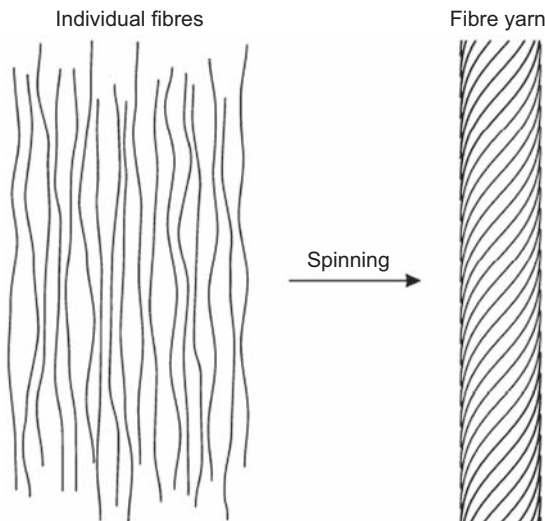

Figure 5.8 Fibre spinning (Rask and Madsen, 2011).

Few experimental data that take into account significant variations of twist levels or linear densities are given in the literature. On Fig. 5.9, the effect of twist level is shown on the tenacity and the deformation at break identified during tensile tests of 500 and 100 tex flax yarns at the GEMTEX Lab (Lansiaux et al., 2019). The influence of the twist level on the tenacity follows the typical effect described in Fig. 5.8, but also depends on the linear density. An increase of the twist level results in an increase of the deformation at break which can be significant.

- Wrapping/comingling/micro-braiding Yarns

The wrap spun yarn consists of twist-less staple fibres wrapped by a filament or a fine thread (Fig. 5.11, left). The wrapping filament applies the fibre-to-fibre pressure that is required to create the friction between the fibres and thus the yarn strength (Xie et al., 1986a,b,c). Because of the lower fibre-to-fibre pressure generated by the wrapping filament in comparison to the one generated by the twist, wrap spun yarns generally exhibit lower tensile strength and are less compact than the ring spun yarns at their optimal twist level (Zhang and Miao, 2010). Zhang et al applied this technology with flax and hemp staple fibres wrapped by a PP multifilament yarn (Zhang and Miao, 2010). This co-wrapping technology was also presented in (Baghaei et al., 2013) with Hemp/PLA or by Jiang and Chen (2012) for flax/PP commingled yarns.

Micro-braiding, another technique to assemble staple fibres can also be considered. Jute and sisal micro-braids were manufactured and described in (Khondker et al., 2006; Jayaraman, 2003). A tubular braiding machine was used to produce micro-braid yarn using a continuous jute yarn inserted axially and a polymer yarn as the matrix material braided around the reinforcing jute thread (Khondker et al., 2006). This technology, illustrated in Fig. 5.10 (right), has also been used for hemp/PLA micro-braided yarn by Kobayashi and Takada (2013).

To manufacture natural hybrid yarns, the third possibility described in this section deals with comingled yarns by the friction spinning system, DREF-3 (Fig. 5.10, below). Natural fibres can be fed in a rectilinear way, via a tensioning unit, into a spinning device. The straight path of the yarn ensures that no filament damage occurs. Above the friction drums there is a drafting device with an opening unit. After feeding, slivers are opened-up into individual elements by a pinned beater and then transferred to the yarn forming zone to wrap over the core flax yarn.

These technologies are used intensively to manufacture hybrid yarns with thermoplastic polymer. In these hybrid yarns, the reinforcing components based on natural fibres form the core of the structure and thermoplastic polymers are wrapped (by wrapping, micro-braiding or DREF-spinning) over the core flax yarn. Bar et al. (2017, 2018) have used this technology with Flax/PP materials. These comingled yarns with thermoplastic polymers improve the quality of impregnation of the composite material during the thermo-compression step. Alagirusamy et al. (2006) summarized various techniques of hybrid yarn manufacturing and explained their effectiveness as thermoplastic composite reinforcing materials. These technologies are also used for synthetic fibres as described in (Selver et al., 2017; Sathishkumar et al., 2014).

- Bound by an adhesive yarns

Long natural technical fibres that are generally considered for reinforcing structural composite parts possess an average length of about 300 mm. Because of their finite

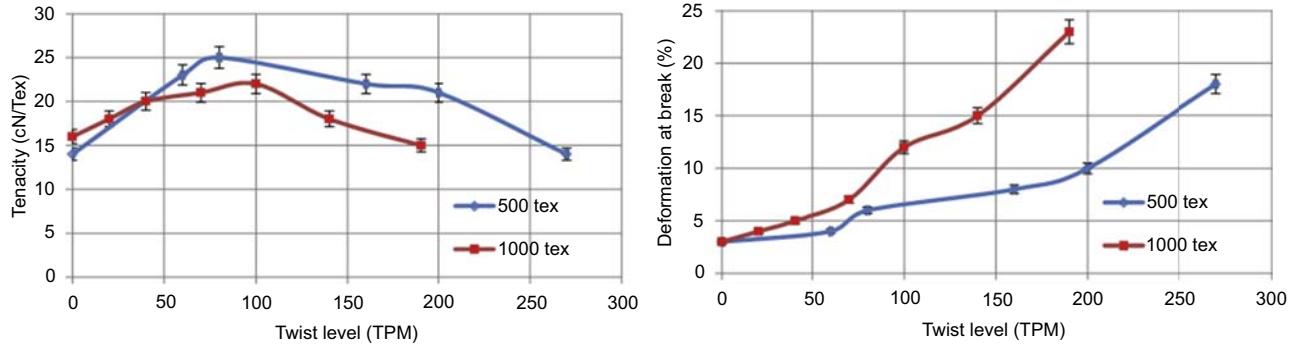

Figure 5.9 Tenacity (Left) and deformation at break (right) of flax yarns as a function of twist level.

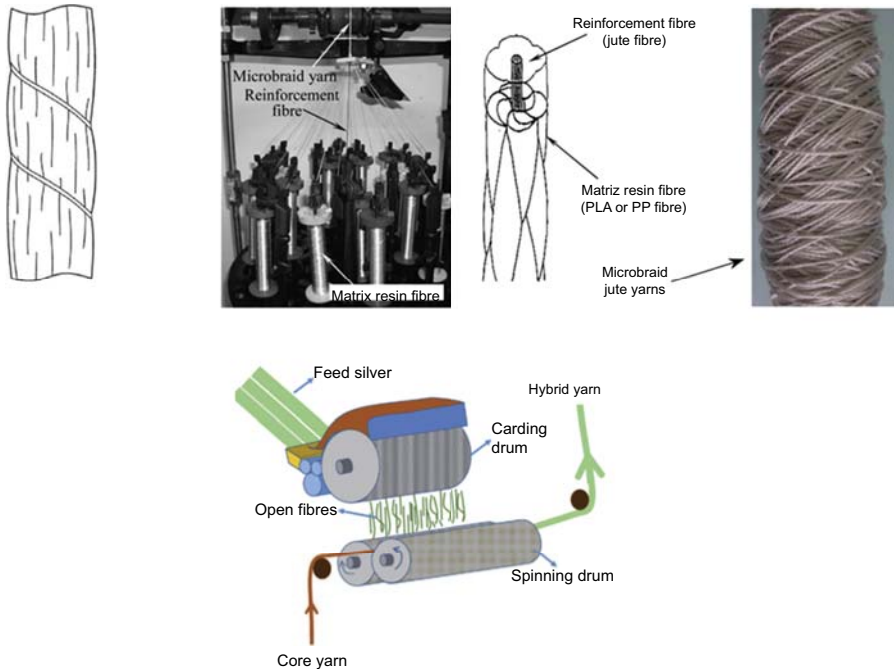

Figure 5.10 Left: warping staple natural fibres with a thread (Zhang and Miao, 2010). Right: Micro-braiding technology (Kobayashi and Takada, 2013). Below: DREF-3 spinning system (Bar et al., 2018).

length, the technical fibres (flax, hemp), cannot be treated in the same way as synthetic fibres of infinite length such as glass or carbon.

After the different preparation steps described in the previous section leading to slivers of calibrated linear mass, a spinning step giving cohesion to the technical fibres is performed, because the slivers cannot sustain the different loads applied to them during the textile construction processes such as weaving, braiding or knitting. This increases the level of torsion of the fibres and as a consequence the level of tensile resistance of the yarn. However, providing torsion to the fibres within the yarn may lead to difficulties of impregnation of the core of the yarn and to a reduction of the tensile properties at the composite scale (Goutianos and Peijs, 2003; Shah et al., 2013b). Spinning is also a step that consumes a large amount of energy (23 GJ/T) in comparison to scutching and hackling (9.39 and 2.23 GJ/T respectively). As a consequence, the amount of energy required to produce a reinforcement fabric with such yarns (86 GJ/T) is higher than that needed to produce an equivalent product from glass fibres (55 GJ) (Dissanayake et al., 2009).

To maximise the high potential of natural fibres for the reinforcement of composite materials, it is therefore recommended to keep the fibre bundles as aligned as possible and to maximise the fibre volume fraction. In the case of woven fabrics or braids, the use of flat yarns such as the ones that are generally used for synthetic products should be promoted to reach high covering factors and therefore high fibre volume fractions.

To achieve this goal, the technical fibres need to be bound together so that they can sustain the loads they are subjected to during the textile construction process. Fig. 5.11 shows a detailed view of flax bonded by an adhesive yarn. Different types of adhesive may be employed. Generally, the manufacturers do not indicate the type of adhesive they use. Several solutions are already used in the textile industry to bind the fibres and avoid any fibrillation. They are based on techniques already used to apply sizing to glass or carbon roving type yarns. This consists of pulling the roving or the sliver through a bath of an adhesive solution and pressing out the excess between compressive rollers. The adhesive solutions can either be synthetic or bio-based. Ideally, the adhesive should be removed at the end of the textile construction process with a minimum impact on the environment. Different commercial alternatives can be encountered. Of course epoxy based solutions (that can be partially bio-based), potentially of the same nature as the epoxy that could be used to manufacture the composite part, can be considered (Sicomina. <http://www.sicomina.com>). It is also possible to use products such as the ones currently used by the textile industry to prepare the warp yarns. PVA adhesives are widely used in the textile industry, particularly in North America as a warp sizing agent. PVA based formulas are also available in large quantities on the market (Kuraray. www.kuraray.com). Natural polymers can also be considered as adhesives. As an example, formulated potato starches are used and could be considered to bind natural fibre bundles (Avebe. www.avebe.com/text) (Suedstaerke. <http://www.suedstaerke.com>). Other substances called gums have adhesive properties and can also be considered (Imam et al., 2013). They are extracted from the bark of trees or shrubs such as the ones of the pea family (Britannica. www.britannica.com). One can cite as an example gum tamarind (Parija et al., 2001) which was used as a binder with sisal fibres (Veluraja et al., 1997), or locust bean gum and Arabic gum which are used as sizing agents for textiles (Oswamani et al., 2004).

Ideally, it is important to remove the binding agent applied to the yarn for the textile construction process. The removal of the agent depends on its nature. As an example, starch based adhesives can be removed by using catalytic action of enzymes. For water soluble sizes such as PVA or certain gums such as Arabic gum, it is possible to wash



Figure 5.11 Flat binding-by-an-adhesive yarn.

the textile with high amounts of hot water. However, the water becomes polluted by the sizing agents and needs to be treated, recycled or used for gas generation (Opwis et al., 2012).

5.3.2.2 *Textile architecturation techniques for 2D and 3D fabrics*

The definition and properties of textile reinforcements are essential factors during composite manufacturing and for the performance of composite materials. The architecture of the reinforcement controls the deformability of the preform during the first step of the RTM process (Wang et al., 2017). The porosities (size and distribution) are also key parameters that control the injection process. For the specification of composite materials, load transfer from the matrix to the reinforcement is governed by the fibre orientation, which plays a main role in the composite stiffness. Fibre direction and fibre volume fraction can be managed during the manufacturing process of the reinforcement by textile technologies such as weaving, knitting or braiding. Yarn is converted into fabrics by using these textile technologies. The processes of interlacing, interlooping, braiding, fitting, laminating, and bonding involving usage of yarns is called fabric construction and the resultant material is called the fabric.

The fabrics obtained by these technologies are considered as 2D as the fibres are almost oriented in one plane. At the level of un-impregnated fabrics, weaving yarns into fabrics for easier handling, for example, introduces fibre crimp which reduces the mechanical properties of the reinforcements. Other textile variabilities such as yarn spacing, yarn path waviness, and wrinkling can also significantly influence subsequent properties (Gommer et al., 2016). Misnon et al. (2015) have shown that for two woven hemp fabrics with the same textile properties (crimp, areal density, linear density of yarns, warp/weft density) the differences in their tensile strengths and tensile moduli are not significant. Some characterization at the level of flax-based woven fabrics are presented in (Ouagne et al., 2013; Capelle et al., 2014) for the shape forming. Bensadoun et al. (2015) have reported on the changes in tensile moduli and tensile strength of composites manufactured from nine flax-fabric architectures (mat, plain weave, twill, quasi-UD, UD ...) with different areal densities. A multi-level approach (tensile behaviour of un-impregnated yarns and fabrics and composites) was proposed recently by Blanchard et al. (2016), and they showed that the wide variability in terms of tensile properties recorded at the scale of flax-fibre yarns decreases at the scale of fabrics and composites. The mechanical and damping properties were measured for unidirectional, 0/90 and twill 2/2 flax fibre composites containing 40 vol% of fibres in an epoxy matrix by Duc et al. (2014). On three different quasi-UD fabrics weaved from flax yarns with similar linear densities but different twist levels, Omrani et al. (2017b) pointed out the influence of the weaving process on the tensile behaviour of flax yarns and fabrics. The degradation during the weaving can be observed on the flax yarns and the twist effect can help to reduce this degradation. From twisted flax yarn (350 Tex, 185 TPM), Xue and Hu (2013) detailed the manufacturing of a non-crimp biaxial weft-knitted fabric. The influence of treatment with sodium hydroxide (NaOH) applied on yarns was studied on the tensile properties of the flax yarns, biaxial weft-knitted reinforcements, and at the scale of flax composites. Woven and

braided textile structures are widely used as the composite reinforcements. In a woven structure, the warp and weft directions are interlaced at 90 degrees to each other. Biaxial braiding structure has two principal sets of tows called bias tows. Compared to woven fabric the braid angle is its main characteristic. The braid angle is defined as the angle between axial direction and bias tow and is in the range 5 degrees–85 degrees. From flax/PA12 commingled yarns the production of biaxial braids with a braiding angle of 35 degrees was presented by [Jacquot et al. \(2016\)](#). The formability behaviour was analysed and compared to woven fabrics made with the same yarns.

These studies concern mostly 2D reinforcement, but some new developments of weaving methods for 3D-woven preforms are appearing in the literature. These are mainly manufactured from glass, carbon, polyester or aramid fibres. [Lansiaux et al. \(2019\)](#) ([Fig. 5.12](#)) have recently described the feasibility of realizing 3D warp interlock fabrics from flax flat yarns, and analyzed the influence of architectural parameters of these 3D-reinforcements on the mechanical parameters.

5.3.2.3 Deformability of reinforcement textiles

Shape forming of different textile architectures manufactured from aligned fibre flax yarns was demonstrated ([Ouagne et al., 2011b, 2013](#); [Jacquot et al., 2016](#)) from woven fabrics or braids. Globally, the challenge associated with shape forming is similar to the one for forming glass or carbon based fabrics with similar yarn geometry. Different modes of deformation take place during forming. These are mainly in-plane shear, bending and tension of the reinforcement membrane. These loads are imposed at the same time on the material and are therefore coupled. This may favour the appearance



Figure 5.12 Manufacture of 3D-warp interlock from flax rovings at Gemtex-Lab.

of defects, depending on the shape complexity and the yarn architecture, as reported by [Potter et al. \(2008\)](#). When flat yarns with aligned fibres are considered, defects such as tow buckles were reported to appear because of the yarn geometry, and also because of the high lateral stiffness conferred to the yarn by the addition of an adhesive ([Fig. 5.12](#)). This is not specific to natural fibre based materials ([Allaoui et al., 2014](#)) but the phenomenon is increased if adhesives are used to bind natural fibre bundles together as it increases greatly the lateral stiffness of the yarn and therefore the bending angle at which the phenomenon takes place. A more specific defect associated with the use of textiles manufactured from finite length fibre bundles may happen during forming and was reported by [Ouagne et al \(2012\)](#). Despite the use of adhesives, high strains were measured during forming ([Ouagne et al., 2012b](#)). These high strains are higher than the strain at which movements of bundles take place within the yarn under uni-axial or in bi-axial tension conditions ([Ouagne et al., 2012a](#)). The movements of packets of bundles were well reported by [Moothoo et al. \(2014\)](#). They showed that local variations of fibre density take place. This is of course expected to be a source of inhomogeneity and therefore of weakness for the formed composite part. When adhesives are removed/washed after textile production, the strains observed during forming are even larger and therefore, the tensile resistance of the tows is low, and high strains may be observed in tows.

Solutions to prevent or to minimise the appearance of these specific defects have been proposed, and are based on various studies of this type of defect ([Ouagne et al., 2013, 2016; Capelle et al., 2014; Tephany et al., 2016](#)). Solutions consist of adjusting the textile geometry ([Ouagne et al., 2013](#)) to remove the space where tow buckles take place, or by adjusting the forming device and particularly the blank-holder design to reduce the tension of the yarns associated with the high strains reported in the previous paragraph ([Capelle et al., 2014](#)). A complex tetragonal shape ([Fig. 5.13](#)) without defect was obtained from a textile that was not specifically designed to prevent defects, by adjusting the forming process parameters and blank holder design. The extra challenge associated with the forming of textiles

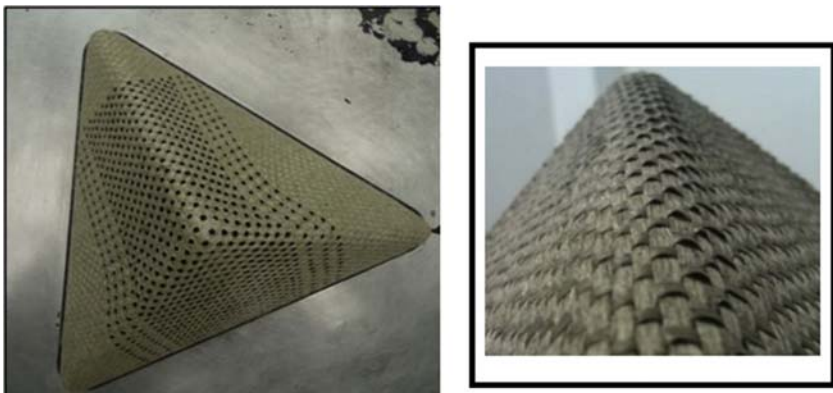

Figure 5.13 Left: Achieved complex shape forming; Right: Appearance of tow buckling.

manufactured from natural fibre bundles was therefore met, and it was shown that with adequate materials and the appropriate process parameters it is possible to manufacture complex shape composite materials for load bearing applications with special designs manufactured from high capacity fibre bundles extracted from plants such as flax.

It is also possible to form non-woven fabrics (Omrani et al., 2017a) with relatively complex shapes such as hemispherical or corners. The main mechanism associated with non-woven textile forming is the movement of fibres within the fabric to accommodate the shape. In this case, variations of fibre density may be observed in high deformation zones. It is therefore important in this case to anticipate the density evolution in order to prevent the formation of zones with too low fibre densities, which could lead to weaknesses in composites.

5.4 Flax fibre geotextiles

Natural fibre-based geotextiles have found a particular interest for the last 2 decades as an increasing knowledge of natural fibre properties has been gained. Primary uses of geotextiles are separation or stabilization, drainage, erosion control and reinforcement of road sides or river banks. If plastic based geotextiles were mainly used up to recently, some concerns about their end of life and their impact on the environment led to the design of natural fibre based products. Widely-open woven textiles (Fig. 5.14), quasi exclusively manufactured manually from coir fibres and industrially from jute fibres, are more easily biodegraded at the end of their service life than plastic based materials. However, to be suitable for a geotextile use such as soil stabilization, natural fibre materials should have reasonably good mechanical properties, good resistance to biodegradation such as resistance to microbial attacks (Leao et al., 2012).

Coir, jute, and flax fibers are mainly composed of cellulose, hemicellulose, pectin and lignin but coir fibers present an higher lignin percentage (Yan et al., 2014;



Figure 5.14 Textile tow woven geotextile.

Rencoret et al., 2013). Consequently, when submitted to the natural soil degradation performed by microbial population (Hu and van Bruggen, 1997) flax fibers will likely present higher sensitivity compared to coir fibers as lignin degrading organisms are less widespread than cellulolytic ones.

Flax tows from textile varieties and flax fibres from oleaginous varieties are by-products of the textile and vegetal oil industries respectively. They represent in France large renewable resources that could be used to manufacture geotextiles industrially. From a mechanical point of view, flax fibres have higher tensile strength, compared to coir fibres (Batra et al., 1998; Kostic et al., 2008; Sharma, 1997). Up to now the highest properties are reported for flax and nettle fibres slightly above hemp (Baley and Bourmaud, 2014; Lefeuvre et al., 2014; Marrot et al., 2013; Duval et al., 2011; Placet, 2009; Dhakal and Zhang, 2015). However, their weak point is their low anti-microbial activity (Konczewicz and Kozlowski, 2012; Borsa, 2012; Fillat et al., 2012). This may be due to the low micro-fibrillar angles observed for flax and hemp (about 10 degrees and 6 degrees respectively (Ho Thi, 2008)) as compared to coir 45 degrees. Indeed, high micro-fibrillar angles have for consequence to reduce the sensitivity to microorganism attack (Szostak-Kotowa, 2004). So solutions to improve their resistance to microorganisms' degradation should be studied (Lee et al., 2013; Alonso et al., 2009).

5.4.1 Degradation of geotextiles

Flax fibres are lignocellulosic fibres, mainly constituted of cellulose, hemicellulose, pectin and lignin (Buranov and Mazza, 2008). Natural lignocellulose biodegradation depends on environmental conditions and on the degradation capacity of the microbial population (Waldrop et al., 2000). Soil-dwelling fungi and bacteria (*Aspergillus niger*, *Cellvibrio*, ...) produce enzymes such as cellulase to reduce cellulosic part of fibres to glucose, fructose, xylose,... which they use as nutrients.

A protocol to estimate the carbohydrate degradation, of flax fibres using FTIR and sugar released measurements was developed (Renouard et al., 2014). This is particularly important since carbohydrates constitute the main flax fibres components. The evolution of the flax fibres composition can be determined using specific ATR-FTIR ratios characteristics of the amounts of crystalline and amorphous cellulose, xyloglucan and $\beta(1-4)$ xylan (the main hemicellulose component) and the galacturonic acid, a specific component of the pectin.

Flax fibres are naturally degraded by cellulolytic bacteria in soil (Waldrop et al., 2000). In this work, *Cellvibrio fulvus* and *Cellvibrio vulgaris* isolated from rhizosphere soils (Blackall et al., 1985) and *Cellvibrio gandavensis* obtained from soil enriched with flax and sisal fibres (according to provider information's) were used. These bacterial strains are representative of *Cellvibrio* variability.

Average values of tensile strengths of as-received flax, hemp and coir fibres are presented in Table 5.3 as a comparison basis for the evolution of the tensile properties with different treatments. One can observe that the tensile strength of the flax yarns (72 ± 7 MPa). In the meantime, Table 5.3 also indicates that the tensile strength of flax yarns is much higher than the one of the reference coir yarn used to elaborate

Table 5.3 Physical and Tensile properties of un-processed flax, and coir yarns.

	Yarns fineness (tex)	Torque (rd/m)	Tensile strength (MPa)	Young's modulus (MPa)
Flax	4187 ± 396	64	72 ± 7	759 ± 40
Coir	6172 ± 1754	Double twisted yarn	14 ± 2	91 ± 24

commercial geotextiles (14 ± 2 mPa). The flax yarn strength is 5.1 times higher than the coir yarn one. The ratios become even larger if one compares the relative strength values (strength/fineness) because the fineness of flax yarns is 1.5 times lower. In this case, the relative flax strength is 7.6 times higher than the coir reference value. (Table 5.3).

When submitted to enzymatic and bacterial environments described in the previous paragraphs, the as received flax yarns show large statistically significant tensile strength decreases when compared to their initial properties. The tensile strength values for enzymatic and microbial degraded flax yarns shows respectively a decrease of 33% and 38%. This shows that for both approaches large tensile strength decreases took place.

It is also very interesting to note that the values of the degraded as received flax yarns (unprotected) exhibit strength values that are larger than the strength of the non-degraded by enzymatic or bacterially reference coir based yarn. The degraded strength of flax is respectively larger by afactors of about 3.

For as received yarns, statistically significant drops of young's modulus are observed after enzymatic and bacterial attacks Fig. 5.15a. For flax, both the attacks result in globally equivalent results (-45%) with no statistical difference between the enzymatic and the bacterial degradation.

The enzymatically and bacterially degraded as received flax (unprotected) exhibit moduli values that are larger than the ones of the non-degraded by enzymatic or bacterial attack reference coir based yarn (Fig. 5.15a). The degraded modulus of flax is y larger by factors of about 4.

5.4.2 Solutions to control the biodegradation of the textiles

Different solutions exist to control a too fast biodegradation of lignocellulosic fibres submitted to humid environments and of course to the attacks of bacteria and fungi from the soil. One of the solution that is used at the present time by the manufacturers of jute based geotextiles consists in applying mineral oil on the fibres. This oil, under an emulsion form, is initially used to favour and ease the textile processing steps from the fibre to the yarn and fabric manufacturing. This oil, easily detectable because of its strong odour also confers to the woven geotextiles resistance properties to the soil bacteria and fungiis. The use of such mineral oils is of course not very much in adequation with the use of biodegradable natural fibres as the idea of using such products instead

Tensile strength (MPa)

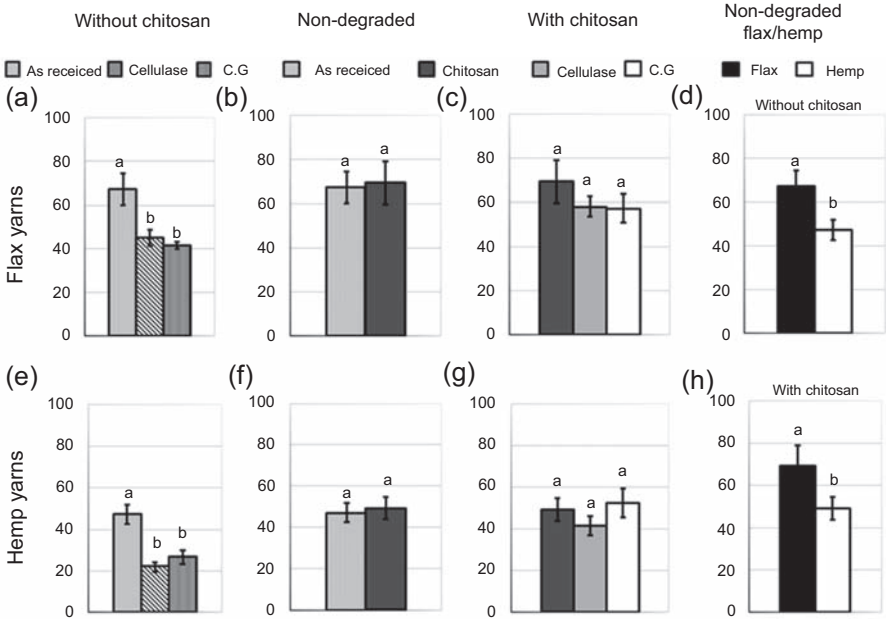

Figure 5.15 Evolution of tensile strength of flax and hemp yarns for different protection and degradation treatments (Ouagne et al., 2017b). (a) Degradation of flax yarns by cellulase and Cellvibrio Gandavensis; (b) Influence of chitosan impregnation for flax yarns tensile strength; (c) Degradation of flax yarns impregnated by chitosan by cellulase and Cellvibrio Gandavensis; (d) Tensile strength comparison of flax and hemp yarns; (e) Degradation of hemp yarns by cellulase and Cellvibrio Gandavensis; (f) Influence of chitosan impregnation; (g) Degradation of hemp yarns impregnated by chitosan by cellulase and Cellvibrio Gandavensis; (h) Tensile strength comparison of flax and hemp yarns impregnated by chitosan; Measurements associated to different letters differ significantly one from another at $P < .05$ using Student test.

of the plastic based material is to reduce the impact on the environment. When mineral oils impregnate the jute fibres, this oil, is not degraded by the environment during the service life of the geotextile and this one pollutes the soils or migrates to the closest water network. Alternative resistance protection treatments should therefore be developed so that the geotextile resist during its service life to the environmental attacks and this with a minimum impact on the environment.

Different solutions can be proposed. One of them consists in impregnating the yarns in a chitosan protection solution. Chitosan is a natural polymer produced by sea shells. It is a widely available resource (the second most abundant biopolymer on earth after cellulose) and it can be degraded by the environment and does not pollute the river network. Chitosan is also particularly interesting because it possesses bacteriostatic and fungicidal properties. Flax and hemp yarns were submerged into a chitosan solution, prepared with dissolved chitosan powders in 1% acetic acid at room temperature.

Solutions were stirred for 8 h. Yarns were then immersed in chitosan solution under shaking for 16h. The impregnated yarns were then dried in an oven, at 37°C during 3 days (Renouard et al., 2014).

Results on mean tensile strength of chitosan protected yarns are presented in Fig. 5.16b. They do not show any significant difference between the as received strength and the chitosan treated one. The ratio is globally not affected by the addition of the protection layer. The strength value for flax yarns treated by chitosan is respectively 69 ± 10 MPa and 49 ± 5 MPa. It is important to note that the addition of the protective layer of chitosan does not almost change the tensile resistance of the flax yarns.

When impregnated by chitosan, the yarn rigidity (Young's modulus) of flax is not statistically affected (Fig. 5.16b). The addition of chitosan does not reduce the modulus of flax yarns.

When submitted to enzymatic and microbial attacks, no significant difference can be observed between the chitosan impregnated yarns before and after attacks (Fig. 5.16c). This therefore indicates that the chitosan as initially expected well prevents the degradation of the tensile resistance of the cellulose rich flax fibres.

Other solutions were also tested by Renouard et al. (2017) at the laboratory scale. It consists in applying a sacrificial cellulose coating on the surface of the fibres. The cellulose coating provides an efficient physical protection, preventing access of these enzymes to their fibrous substrate. The possibility of conferring antibacterial properties on the cellulose coating by chelating phytoalexin molecules such as gramine on it was tested and this solution was shown to be effective against soil cellulolytic bacteria such

Young's modulud (MPa)

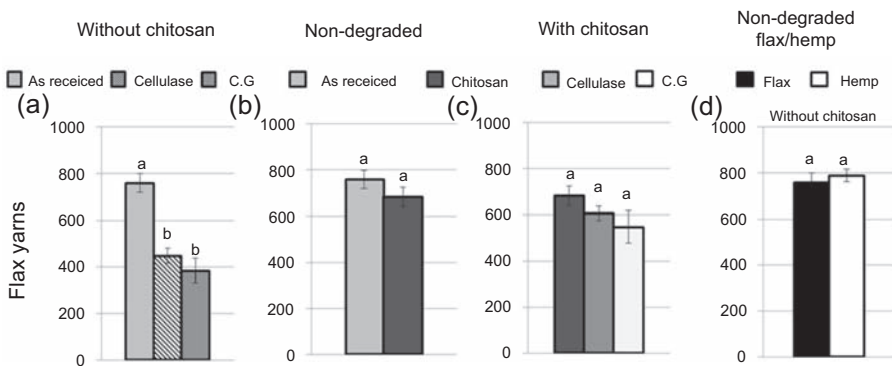

Figure 5.16 Evolution of young's modulus of flax yarns for different protection and degradation treatments (Ouagne et al., 2017b). (a) Degradation of flax yarns by cellulase and Cellvibrio Gandavensis; (b) Influence of chitosan impregnation for flax yarns Young's Modulus; (c) Degradation of flax yarns impregnated by chitosan by cellulase and Cellvibrio Gandavensis; (d) Young's Modulus comparison of flax and hemp yarns; Measurements associated to different letters differ significantly one from another at $P < .05$ using Student test.

as *Cellvibrio fulvus* and *Cellvibrio vulgaris*. As a consequence, coating flax yarns with cellulose associated with antibacterial molecules could contribute to obtaining a longer service life in soil for geotextiles manufactured from flax fibres.

Section 4 of this paper shows that flax tows (the by-products of the flax scutching industry) can be used if protected by components such as chitosan or cellulose to manufacture high performance geotextiles such as the one presented in Fig. 5.15. The use of linseed flax such as the ones described in Section 2.1 could also be seriously considered so that to use a resource that is at the present time almost not valued.

5.5 Conclusions

Flax (*Linum usitatissimum* L.) has been grown since the antiquity for its ability to provide fibres for the confection of clothes. It has also been used for the production of technical fabrics such as sails for example. In the 20th century, and particularly in Europe, the vegetal fibres such as flax were progressively replaced by synthetic fibres from petroleum origin. However, a large regain of interest for vegetal fibres and particularly for flax fibres was observed in the last 2 decades for using these fibres in challenging new applications for which the environmental impact is considered.

Different varieties of *Linum usitatissimum* L. have been selected by breeder to optimise the production of fine long fibres (textile flax) or to optimise the production of seeds (linseed or oleaginous flax). In both cases, bast fibres can be extracted from the flax stems. This chapter shows that the fibres extracted from either textile or linseed flax varieties can be used for different technical textiles for high added value applications. In a first part, the chapter deals with the different processes used to extract and prepare the fibres for textile applications according to the growth and harvesting techniques considered. In a second part, different manufacturing processes or techniques to produce flax fibre non-woven and woven textiles for composite reinforcements are presented. A discussion about the interest of selecting a particular type of yarn or a particular 2D or 3D architecturation technique is also presented in relation to different composite requirements and applications. The third part of this chapter is dedicated to the interest of using flax fibres for non-woven and woven geotextile applications. Specificities associated to the use of biodegradable vegetal fibres are presented and solutions to control the degradation time of the textiles with a minimum impact on the environment are also discussed in the document.

This work demonstrated that flax fibres (either from textile or linseed varieties) can advantageously be used for technical industrial applications ranging from the composites materials for load bearing uses to ecological engineering and civil engineering applications for geotextiles. Different testing techniques used to characterise, select or control the textile structures at different scales (from the fibre to the fabric) should be employed so that to continue improving the performances of these fibrous materials. One may think of micro or nanotomographic techniques for example. If the flax production uses mature technologies for the garment industry, some improvements regarding technical applications can still be investigated specially to increase the

confidence of the market about the high performance and the durability of the newly designed products. Finally, it might also be important to explain that the flax demand is nowadays very high for the garment industry and as a consequence, other sources of high performance natural fibres should be explored. This may be the case of hemp which fibres are mainly used at the present time for paper or low load bearing composite applications using short fibres. New value chain developments are in progress so that to demonstrate at an industrial scale the possibility to use this well known fibre for high added value applications and therefore complete the offer of the flax industry.

References

- ADEME Report, 2011. Assessment of Natural Fibre Availability in France. http://www.ademe.fr/sites/default/files/assets/documents/76290_12_evaluation_dispo_accessibilite_fibres_veg_usages_materiaux.pdf.
- Alagirusamy, R., Fanguero, R., Ogale, V., Padaki, N., 2006. Hybrid yarns and textile preforming for thermoplastic composites. *Text. Prog.* 38, 1–71. <https://doi.org/10.1533/tepr.2006.0004>.
- Alawar, A., Hamed, A.M., Al-Kaabi, K., 2009. Characterization of treated date palm tree fiber as composite reinforcement. *Compos. Part B* 40, 601–606.
- Allaoui, S., Hivet, G., Soulat, D., Wendling, A., Ouagne, P., Chatel, S., 2014. Experimental preforming of highly double curved shapes with a case corner using an interlock reinforcement. *Int. J. Material Form.* 7, 155–165. <https://doi.org/10.1007/s12289-012-1116-5>.
- Alonso, D., Gimeno, M., Olayo, R., Vaquez-Torres, H., Sepulveda-Sanchez, J.D., Shirai, K., 2009. Cross linkink chitosan into UV-irradiated cellulose fibers for the preparation of antimicrobial-finished textiles. *Carbohydrates Poly.* 77, 536–543.
- Anandjiwala, R.D., Boguslavsky, L., 2008. Development of needle-punched non-woven fabrics from flax fibres for air filtration applications. *Text. Res. J.* 78, 614–624. <https://doi.org/10.1177/0040517507081837>.
- Avebe. www.avebe.com/textile-warp-sizing/n.d.
- Baets, J., Plastria, D., Ivens, I., Verpoest, I., 2014. Determination of the optimal flax fibre preparation for use in unidirectional flax–epoxy composites. *J. Reinf. Plast. Compos.* 33, 493–505. <https://doi.org/10.1177/0731684413518620>.
- Baghaei, B., Skrifvars, M., Berglin, L., 2013. Manufacture and characterisation of thermoplastic composites made from PLA/hemp co-wrapped hybrid yarn prepregs. *Compos. Part A Appl. Sci. Manuf.* 50, 93–101. <https://doi.org/10.1016/J.COMPOSITESA.2013.03.012>.
- Baley, C., 2002. Analysis of the flax fibres tensile behaviour and analysis of the tensile increase. *Compos. Part A* 33, 2143–2145.
- Baley, C., Bourmaud, A., 2014. Average tensile properties of French elementary flax fibers. *Mater. Lett.* 122, 159–161.
- Bar, M., Das, A., Alagirusamy, R., 2017. Studies on flax-polypropylene based low-twist hybrid yarns for thermoplastic composite reinforcement. *J. Reinf. Plast. Compos.* 36, 818–831. <https://doi.org/10.1177/0731684417693428>.
- Bar, M., Das, A., Alagirusamy, R., 2018. Effect of interface on composites made from DREF spun hybrid yarn with low twisted core flax yarn. *Compos Part A Appl Sci Manuf* 107, 260–270. <https://doi.org/10.1016/j.compositesa.2018.01.003>.

- Batra, S.K., 1998. Other long vegetable fibers. In: Lewin, M., Pearce, E.M. (Eds.), *Handbook of Fibre Science and Technology. Fibre Chemistry*, vol. 4. Marcel Dekker, New York, pp. 505–575.
- Belaadi, A., Bouchak, M., Aouici, H., 2016. Mechanical properties of vegetal yarn: statistical approach. *Compos. B Eng.* 106, 139–153. <https://doi.org/10.1016/J.COMPOSITESB.2016.09.033>.
- Bensadoun, F., 2016. In-service Behaviour of Flax Fibre Reinforced Composites for High Performance Applications. Phd-thesis of Faculty of Engineering Science, KU Leuven.
- Bensadoun, F., Vallons, K.A.M., Lessard, L.B., Verpoest, I., Van Vuure, A.W., 2015. Fatigue behaviour assessment of flax-epoxy composites. *Compos Part A Appl Sci Manuf* 82, 253–266. <https://doi.org/10.1016/j.compositesa.2015.11.003>.
- Biagiotti, J., Puglia, D., Kenny, J.M., 2004. A review on natural fibre-based composites-Part I. *J. Nat. Fibers* 1 (2), 37–68.
- Blackall, L., Hayward, A., Sly, L., 1985. Cellulolytic and dextranolytic Gram-negative bacteria: revival of the genus *Cellvibrio*. *J. Appl. Microbiol.* 81, 97-59.
- Blanchard, J.M.F.A., Sobey, A.J., Blake, J.I.R., 2016. Multi-scale investigation into the mechanical behaviour of flax in yarn, cloth and laminate form. *Compos. B Eng.* 84, 228–235. <https://doi.org/10.1016/j.compositesb.2015.08.086>.
- Bodros, E., Baley, C., 2008. Study of the tensile properties of stinging nettle fibres. *Mater. Lett.* 62, 2143–2145.
- Boettcher, P., Schmalz, E., 1993. Flax in non-wovens. *Text Prax Int* 48, 585.
- Boisse, P., Hamila, N., Vidal-Salle, E., Dumont, F., 2011. Simulation of wrinkling during textile composite reinforcement forming. Influence of tensile in-plane shear and bending stiffnesses. *Compos. Sci. Technol.* 71 (5), 683–692. <https://doi.org/10.1016/j.compscitech.2011.01.011>.
- Borsa, J., 2012. Antimicrobial natural fibres. In: *Handbook of Natural Fibres: Processing and Applications*. Woodhead publishing, pp. 428–466.
- Britannica. www.britannica.com/technology/gum-adhesive n.d.
- Buntain, M.J., Bickerton, S., 2007. Modeling forces generated within rigid liquid composite moldings tools. Part A: Experimental study. *Compos. Part A.* 38, 1729–1741.
- Buranov, A., Mazza, G., 2008. Lignin in straw of herbaceous crops. *Ind. Crops Prod.* 237, 259–28.
- Capelle, E., Ouagne, P., Soulat, D., Duriatti, D., 2014. Complex shape forming of flax woven fabrics: design of specific blank-holder shapes to prevent defects. *Compos. B Eng.* 62, 29–36. <https://doi.org/10.1016/j.compositesb.2014.02.007>.
- Das, D., Pradhan, A.K., Chattopadhyay, R., Singh, S.N., 2012. Composite non-wovens. *Text. Prog.* 44, 1–84.
- Das, D., 2014. Introduction to composite non-wovens. In: Das, D., Pourdeyhimi, B. (Eds.), *Compos. Non-woven Mater. Struct. Prop. Appl.* Woodhead Publishing Series in Textiles, Cambridge, UK. Number 155.
- Decrette, M., Mourad, S., Osselin, J., Drean, J., 2016. Jacquard UNIVAL 100 parameters study for high-density weaving optimization. *J. Ind. Text.* 45, 1603–1618. <https://doi.org/10.1177/1528083714567241>.
- Derbali, I., Terekhina, S., Guillaumat, L., Ouagne, P., 2018. Rapid manufacturing of woven comingled flax/polypropylene composite structures. *Int. J. Material Form.* <https://doi.org/10.1007/s12289-018-01464-1>. Available online.
- Dhakal, H.N., Zhang, Z., 2015. The use of hemp fibres as reinforcement in composites. In: *Biofiber Reinforcement in Composite Materials*, pp. 86–103.

- Dissanayake, N.P.J., Summerscales, J., Grove, S.M., Singh, M.M., 2009. Energy use in the production of flax fibre for the reinforcement of composites. *J. Nat. Fibers* 6, 331–346. <https://doi.org/10.1080/15440470903345784>.
- Duc, F., Bourban, P.-E., Manson, J.-A.E., 2014. Dynamic mechanical properties of epoxy/flax fibre composites. *J. Reinf. Plast. Compos.* 33, 1625–1633. <https://doi.org/10.1177/0731684414539779>.
- Duval, A., Bourmaud, A., Augier, L., Baley, C., 2011. Influence of the sampling area of the stem on the mechanical properties of hemp fibers. *Mater. Lett.* 63, 797–800.
- E. Ecotechnilin. <http://www.eco-technilin.com/activity-process.asp> (n.d).
- Fages, E., Gironés, S., Sánchez-Nacher, L., García-Sanoguera, D., Balart, R., 2011. Use of wet-laid techniques to form flax-polypropylene non-wovens as base substrates for eco-friendly composites by using hot-press molding. *Polym Compos* 33, 253–261. <https://doi.org/10.1002/pc.22147>.
- Fillat, A., Gallardo, O., Vidal, T., Pastor, F.I.J., Diaz, P., Roncero, M.B., 2012. Enzymatic grafting of natural phenols to flax fibres: development of antimicrobial properties. *Carbohydr. Polym.* 87, 146–152.
- Flax, S.-M.J., 2005. In: Franck, R.R. (Ed.), *Bast Other Plant Fibres.*, CRC Press. Woodhead Publishing, Cambridge.
- Frydrych, I., 1992. A new approach for predicting strength properties of yarn. *Text. Res. J.* 62, 340–348. <https://doi.org/10.1177/004051759206200606>.
- Frydrych, I., 1995. Relation of single fibre and bundle strengths of cotton. *Text. Res. J.* 65, 513–521. <https://doi.org/10.1177/004051759506500905>.
- Gnaba, I., Omrani, F., Wang, P., Soulat, D., Ferreira, M., Vroman, P., et al., 2018. Mechanical behavior of flax/polypropylene commingled non-woven at dry scale: influence of process parameters. *Text. Res. J.* <https://doi.org/10.1177/0040517518755789> n.d.;0:0040517518755789.
- Gommer, F., Endruweit, A., Long, A.C., 2016. Quantification of micro-scale variability in fibre bundles. *Compos. Part A Appl. Sci. Manuf.* 87, 131–137. <https://doi.org/10.1016/j.compositesa.2016.04.019>.
- Goutianos, S., Peijs, T., 2003. The optimization of flax fibre yarns for the development of high-performance natural fibre composites. *Adv. Compos. Lett.* 13, 199–215.
- Goutianos, S., Peijs, T., Nystrom, B., Skrifvars, M., 2006. Development of flax fibre based textile reinforcements for composite applications. *Appl. Compos. Mater.* 13, 199–215. <https://doi.org/10.1007/s10443-006-9010-2>.
- Gregory, J., 1953. Cotton yarn structure Part IV—the strength OF twisted yarn elements IN relation to the properties OF the constituent fibres. *J. Text. Inst. Trans.* 44, T499–T514. <https://doi.org/10.1080/19447025308662613>.
- Gu, H., Miao, M., 2014. Optimising fibre alignment in twisted yarns for natural fibre composites. *J. Compos. Mater.* 48, 2993–3002. <https://doi.org/10.1177/0021998313504322>.
- Hammani, A., Trochu, F., Gauvin, R., Wirth, S., 1996. Directional permeability measurement of deformed reinforcement. *J. Reinf. Plast. Compos.* 15, 552–562.
- Hearle, J., Grosberg, P., Backer, S., 1969. *Structural Mechanics of Fibres, Yarns and Fabrics.* Wiley- Interscience, New York.
- Hernandez-Estrada, A., Gusovius, H.J., Müssig, J., Hughes, M., 2016. Assessing the susceptibility of hemp fibre to the formation of dislocations during processing. *Ind. Crops Prod.* 85, 382–388.
- Ho Thi, T.N., 2008. Etude de l'influence de la température et de l'humidité sur les propriétés mécaniques en traction des fibres de chanvre et de coco. PhD. Quebec University.

- Hu, S., van Bruggen, A.H.C., 1997. Microbial dynamics associated with multiphasic decomposition of ¹⁴C-labeled cellulose in soil. *Microb. Ecol.* 33, 134–143.
- Imam, S.H., Bilbao-Sainz, C., Chiou, B.-S., Glenn, G.M., Orts, W.J., 2013. Biobased adhesives, gums, emulsions, and binders: current trends and future prospects. *J. Adhes. Sci. Technol.* 27, 1972–1997. <https://doi.org/10.1080/01694243.2012.696892>.
- INDA. INDA: Association of the Non-woven Fabrics Industry. <http://www.inda.org/>. n.d.
- Jacquot, P.-B., Wang, P., Soulat, D., Legrand, X., 2016. Analysis of the preforming behaviour of the braided and woven flax/polyamide fabrics. *J. Ind. Text.* 46, 698–718. <https://doi.org/10.1177/1528083715591592>.
- Jayaraman, K., 2003. Manufacturing sisal–polypropylene composites with minimum fibre degradation. *Compos. Sci. Technol.* 63, 367–374. [https://doi.org/10.1016/S0266-3538\(02\)00217-8](https://doi.org/10.1016/S0266-3538(02)00217-8).
- Jiang, J., Chen, N., 2012. Preforms and composites manufactured by novel flax/polypropylene cowrap spinning method. *J. Compos. Mater.* 46, 2097–2109. <https://doi.org/10.1177/0021998311430155>.
- Jiang, Z., Hu, Y., Kuang, X., Yu, C., Yang, J., 2014. Simulation on fibre random arrangement in the yarn. *J. Text. Inst.* 105, 1312–1318. <https://doi.org/10.1080/00405000.2014.891685>.
- Jiang, Z., Yu, C., Yang, J., Han, G., Xing, M., 2017. Estimation of yarn strength based on critical slipping length and fibre length distribution. *Text. Res. J.* 16 <https://doi.org/10.1177/0040517517741160>.
- Khondker, O.A., Ishiaku, U.S., Nakai, A., Hamada, H., 2006. A novel processing technique for thermoplastic manufacturing of unidirectional composites reinforced with jute yarns. *Compos Part A Appl Sci Manuf* 37, 2274–2284. <https://doi.org/10.1016/j.compositesa.2005.12.030>.
- Kim, J.T., Netravili, A.N., 2010. Mercerization of sisal fibers: effects of tension on mechanical properties of sisal fibers and fiber-reinforced composites. *Compos. Part A* 41, 1245–1252.
- Kobayashi, S., Takada, K., 2013. Processing of unidirectional hemp fibre reinforced composites with micro-braiding technique. *Compos Part A Appl Sci Manuf* 46, 173–179. <https://doi.org/10.1016/j.compositesa.2012.11.012>.
- Konczewicz, W., Kozłowski, R.M., 2012. Enzymatic treatments of natural fibres. In: *Handbook of Natural Fibres: Processing and Applications*. Woodhead publishing, pp. 168–184.
- Kostic, M., Pejic, B., Skundric, P., 2008. Quality of chemically modified hemp fibers. *Bioresour. Technol.* 99, 94–99.
- Kumar, N., Das, D., 2017. Fibrous biocomposites from nettle (*Girardinia diversifolia*) and poly(lactic acid) fibres for automotive dashboard panel application. *Compos. B Eng.* 130, 54–63. <https://doi.org/10.1016/j.compositesb.2017.07.059>.
- Kuraray. www.kuraray.eu/fileadmin/Downloads/ELVANOL/ELVANOL_technical_data_sheets/Elvanol_R_T-66_DS_Kuraray_P2.pdf (n.d).
- La Mantia, F.P., Morreale, M., 2011. Green composites: a brief review. *Compos. Part A* 42, 579–588.
- Lansiaux, H., Corbin, A.C., Soulat, D., Boussu, F., Ferreira, M., Labanieh, A.R., February, 2019. Identification du comportement mécanique de tissu 3D interlock chaîne à base de mèches de lin. *Revue des Composites et des Matériaux Avancés* 29 (1), 73–81.
- Lawrence, C., 2010. *Advances in Yarn Spinning Technology*. Woodhead Publishing Series in Textiles.
- Leao, A.L., Cherian, B.M., De Souza, S.F., Kozłowski, R.M., Thomas, S., Kottaisamy, M., 2012. Natural Fibres for Geotextiles. *Handbook of Natural Fiber Processing and Applications*. Woodhead publishing, pp. 280–311.

- Lee, H.S., Park, S.H., Lee, J.H., Jeong, B.Y., Ahn, S.K., Muk, C.Y., Choi, D.J., Chang, J.H., 2013. Antimicrobial and biodegradable PLGA medical sutures with natural grapefruit seed extracts. *Mater. Lett.* 95, 40–43.
- Lefevre, A., Bourmaud, A., Morvan, C., Baley, C., 2014. Elementary flax fibre tensile properties: correlation between stress–strain behaviour and fibre composition. *Ind. Crops Prod.* 52, 762–769.
- Lekakou, C., Johari, B., Norman, D., Bader, G., 1996. Measurement techniques and effects on in-plane permeability of woven cloths in resin transfer molding. *Compos. Part A* 27, 401–408.
- Li, X., Bai, S., 2009. Sheet forming of the multy-layered biaxial weft knitted fabric reinforcement. Part 1: On hemispherical surfaces. *Compos. Part A* vol. 40, 766–777.
- Loix, F., Badel, P., Orgeas, L., Geindreau, C., Boisse, P., 2008. Woven fabric permeability: from textile deformation to fluid flow mesoscale simulations. *Compos. Sci. Technol.* 68, 1624–1630.
- Ma, H., Li, Y., Wang, D., 2014. Investigations of fibre twist on the mechanical properties of sisal fibre yarns and their composites. *J. Reinf. Plast. Compos.* 33, 687–696. <https://doi.org/10.1177/0731684413520187>.
- Maity, S., Gon, D.P., Paul, P., 2014. A review of flax non-wovens: manufacturing, properties, and applications. *J. Nat. Fibers* 11, 365–390. <https://doi.org/10.1080/15440478.2013.861781>.
- Marrot, L., Lefevre, A., Pontoire, B., Bourmaud, A., Baley, C., 2013. Analysis of the hemp fiber mechanical properties and their scattering(Fedora 17). *Ind. Crops Prod.* 51, 317–327.
- Martin, N., Davies, P., Baley, C., 2014. Comparison of the properties of scutched flax and flax tow for composite material reinforcement. *Ind. Crops Prod.* 61, 284–292. <https://doi.org/10.1016/j.indcrop.2014.07.015>.
- Merotte, J., Le Duigou, A., Bourmaud, A., Behloul, K., Baley, C., 2016. Mechanical and acoustic behaviour of porosity controlled randomly dispersed flax/PP biocomposite. *Polym. Test.* 51, 174–180. <https://doi.org/10.1016/j.polymertesting.2016.03.002>.
- Merotte, J., Le Duigou, A., Kervoelen, A., Bourmaud, A., Behloul, K., Sire, O., et al., 2018. Flax and hemp non-woven composites: the contribution of interfacial bonding to improving tensile properties. *Polym. Test.* 66 <https://doi.org/10.1016/j.polymertesting.2018.01.019>.
- Mison, M.I., Islam, M.M., Epaarachchi, J.A., Lau, K.T., 2015. Analyses of woven hemp fabric characteristics for composite reinforcement. *Mater. Des.* 66, 82–92. <https://doi.org/10.1016/j.matdes.2014.10.037>.
- Molnar, P., Ogale, A., Lahr, R., Mitschang, P., 2007. Influence of drapability by using thermoforming. *Compos. Sci. Technol.* 67, 3386–3393.
- Moothoo, J., Allaoui, S., Ouagne, P., Soulat, D., 2014. A study of the tensile behaviour of flax tows and their potential for composite processing. *Mater. Des.* 55, 764–772. <https://doi.org/10.1016/j.matdes.2013.10.048>.
- Moryganov, A.P., Galashina, V.N., Dymnikova, N.S., Stokozenko, V.G., Danilov, A.R., 2008. Modification of flax fibres: from research to realization. *Fibre Chem.* 40, 234–240. <https://doi.org/10.1007/s10692-008-9046-1>.
- Mosca, S.M., 1986. Flax in non-wovens. *Text* 62, 29.
- Mussig, J., Haag, K., 2015. The use of flax fibres as reinforcements in composites. In: Faruk, O., Sain, M. (Eds.), *Biofiber Reinforcement in Composite Materials*. Woodhead Publishing Series in Composites Science and Engineering. Number 51.
- Omrani, F., 2017. Caractérisation de la variabilité des propriétés mécaniques aux échelles fils, renforts et composites à base de lin. University of Lille.

- Omrani, F., Wang, P., Soulat, D., Ferreira, M., Ouagne, P., 2017a. Analysis of the deformability of flax-fibre non-woven fabrics during manufacturing. *Compos. B Eng.* 116, 471–485. <https://doi.org/10.1016/j.compositesb.2016.11.003>.
- Omrani, F., Wang, P., Soulat, D., Ferreira, M., 2017b. Mechanical properties of flax-fibre-reinforced preforms and composites: influence of the type of yarns on multi-scale characterisations. *Compos Part A Appl. Sci. Manuf.* 93, 72–81. <https://doi.org/10.1016/J.COMPOSITESA.2016.11.013>.
- Opwis, K., Mayer-Gall, T., Gutmann, J.S., Dammer, C., Titscher, T., Nickisch-Hartfiel, A., et al., 2012. Semi-industrial production of methane from textile wastewaters. *Energy Sustain. Soc.* 2, 1. <https://doi.org/10.1186/2192-0567-2-1>.
- Oswamani, B., Ananjiwala, R., Hall, D., 2004. *Textile Sizing*. Marcel Dekker, Inc.
- Ouagne, P., Bréard, J., 2010. Continuous transverse permeability of fibrous media. *Compos. Part A* 41, 22–28.
- Ouagne, P., Bizet, L., Baley, C., Bréard, J., 2010a. Analysis of the film-stacking processing parameters for PLLA/flax fiber biocomposites. *J. Compos. Mater.* 44, 1201–1215.
- Ouagne P., Soulat D., Allaoui S., Hivet G., 2010b. Mechanical properties and forming possibilities of a new generation of flax woven fabrics. *Proceeding of the 10th International Conference on Textile Composite (Texcomp)*. 26–28 October 2010, Lille, France.
- Ouagne, P., Soulat, D., Hivet, G., Allaoui, S., Duriatti, D., 2011a. Analysis of defects during the preforming of a woven flax reinforcement. *Adv. Compos. Lett.* 20, 105–108.
- Ouagne, P., Soulat, D., Tephany, C., Duriatti, D., Allaoui, S., Hivet, G., 2012a. Mechanical characterisation of flax based woven fabrics and in situ measurements of tow tensile strain during the shape forming. *J. Compos. Mater.* <https://doi.org/10.1177/0021998312467217>.
- Ouagne, P., Soulat, D., Tephany, C., Moothoo, J., Allaoui, S., Hivet, G., et al., 2012b. Complex shape forming of flax based woven fabrics - analysis of the yarn tensile strain during the process. *Mater. Form. ESAFORM 504*, 231–236. <https://doi.org/10.4028/www.scientific.net/KEM.504-506.231>. Trans Tech Publications; 2012.
- Ouagne, P., Soulat, D., Moothoo, J., Capelle, E., Gueret, S., 2013. Complex shape forming of a flax woven fabric; analysis of the tow buckling and misalignment defect. *Compos. Part A Appl. Sci. Manuf.* 51, 1–10. <https://doi.org/10.1016/j.compositesa.2013.03.017>.
- Ouagne, P., Soulat, D., Tephany, C., Gillibert, J., 2016. Measurement of the appearance and growth of tow buckling defect in the frame of complex shape manufacturing process by using fringe projection technique. *Strain* 52, 559–569. <https://doi.org/10.1111/str.12206>.
- Ouagne, P., Barthod-Malat, B., Evon, P., Labonne, L., Placet, V., 2017a. Fiber extraction from oleaginous flax for technical textile applications: influence of pre-processing parameters on fiber extraction yield, size distribution and mechanical properties. *Proc. Eng.* 200, 213–220.
- Ouagne, P., Renouard, S., Michel, D., Laine, E., 2017b. Mechanical properties of flax and hemp yarns designed for the manufacturing of geotextiles. Improvement of the resistance to soil born microorganisms. *J. Textile Eng. Fashion Technol.* 1 (5).
- Pan, N., 1992. Development of a constitutive theory for short fibre yarns: mechanics of staple yarn without slippage effect. *Text. Res. J.* 62, 749–765. <https://doi.org/10.1177/004051759206201208>.
- Pan, N., 1993. Development of a constitutive theory for short fibre yarns Part II: mechanics of staple yarn with slippage effect. *Text. Res. J.* 63, 504–514. <https://doi.org/10.1177/004051759306300902>.
- Pan, N., 1993. Development of a constitutive theory for short fibre yarns: Part III: effects of fibre orientation and bending deformation. *Text. Res. J.* 63, 565–572. <https://doi.org/10.1177/004051759306301002>.

- Pan, N., 1993. Prediction of statistical strengths of twisted fibre structures. *J. Mater. Sci.* 28, 6107–6114. <https://doi.org/10.1007/BF00365030>.
- Pan, N., Hua, T., Qiu, Y., 2001. Relationship between fibre and yarn strength. *Text. Res. J.* 71, 960–964. <https://doi.org/10.1177/004051750107101105>.
- Pandey, J.K., Ahn, S.H., Lee, C.S., Mohanty, A.K., Misra, M., 2010. Recent advances in the application of natural fiber based composites. *Macromol. Mater. Eng.* 295, 975–989.
- Parija, S., Misra, M., Mohanty, A.K., 2001. Studies of natural gum adhesive extracts: an overview. *J. Macromol. Sci. Part C* 41, 175–197. <https://doi.org/10.1081/MC-100107775>.
- Pillin, I., Kervoele, A., Bourmaud, A., Goimard, J., Montrelay N, N., Baley, C., 2011. Could oleaginous flax fibers be used as reinforcement for polymers? *Ind. Crops Prod.* 34, 1556–1563.
- Placet, V., 2009. Characterization of the thermo-mechanical behaviour of Hemp fibres intended for the manufacturing of high performance composites. *Compos. Part A* 40, 1111–1118.
- Potter, K., Khan, B., Wisnom, M., Bell, T., Stevens, J., 2008. Variability, fibre waviness and misalignment in the determination of the properties of composite materials and structures. *Compos Part A Appl Sci Manuf* 39, 1343–1354. <https://doi.org/10.1016/j.compositesa.2008.04.016>.
- Prodromou, A.G., Chen, J., 1997. On the relationship between shear angle and wrinkling of textile composite preforms. *Compos Part A* 28A, 491–503. [https://doi.org/10.1016/S1359-835X\(96\)00150-9](https://doi.org/10.1016/S1359-835X(96)00150-9).
- Puglia, D., Biagiotti, J., Kenny, J.M., 2005. A review on natural fibre-based composites—Part II. *J. Nat. Fibers* 1 (3), 23–65.
- Ramachandran, T., Gobi, N., Rajendran, V., Lakshmikantha, C., 2009. Optimization of process parameters for crease resistant finishing of cotton fabric using citric acid. *Indian J. Fibre Text. Res.* 34, 359–367.
- Rask, M., Madsen, B., 2011. Twisting of fibres in yarns for natural fibre composites. ICCM18 – 18th. Int. Conf. Compos. Mater. Jeju Island, Korea. 5.
- Rencoret, J., Ralph, J., Marques, G., Gutiérrez, A., Martínez, A.T., Del Río, J.C., 2013. Structural characterization of lignin isolated from coconut (*Cocos nucifera*) Coir fibers. *J. Agric. Food Chem.* 61, 2434–2445.
- Rennebaum, H., Grimm, E., Warnstorff, K., Diepenbrock, K., 2002. Fibre quality of linseed (*Linum usitatissimum* L.) and the assessment of genotypes for use of fibres as a by-product. *Ind. Crops Prod.* 16, 201–215.
- Renouard, S., Hano, C., Doussot, J., Blondeau, J.P., Laine, E., 2014. Characterization of ultrasonic impact on coir, flax and hemp fibers. *Mater. Lett.* 129 (32), 137–141, 1837–1846.
- Renouard, S., Hano, C., Ouagne, P., Doussot, J., Blondeau, J.P., Lainé, E., 2017. Cellulose coating and chelation of antibacterial compounds for the protection of flax yarns against natural soil degradation. *Polym. Degrad. Stab.* 138, 12–17.
- Sathishkumar, T.P., Naveen, J., Satheshkumar, S., 2014. Hybrid fibre reinforced polymer composites – a review. *J. Reinf. Plast. Compos.* 33, 454–471. <https://doi.org/10.1177/0731684413516393>.
- Satyanarayana, K.G., Arizaga, G.G.C., Wypych, F., 2009. Biodegradable composites based on lignocellulosic fibers—an overview. *Prog. Polym. Sci.* 34, 982–1021.
- Selver, E., Potluri, E., Selver, P.P., 2017. Glass/Polypropylene commingled yarns for damage tolerant thermoplastic composites. *Eur. Mech. Sci.* 1, 93–103.
- Sicom. <http://www.sicom.com/products/epoxy-systems/bio-based-epoxy-n.d>.
- Shah, D.U., 2014. Natural fibre composites: comprehensive Ashby-type materials selection charts. *Mater. Des.* 62, 21–31. <https://doi.org/10.1016/j.matdes.2014.05.002>.

- Shah, D.U., 2016. Damage in biocomposites: stiffness evolution of aligned plant fibre composites during monotonic and cyclic fatigue loading. *Compos. Part A Appl Sci Manuf* 83, 160–168. <https://doi.org/10.1016/j.compositesa.2015.09.008>.
- Shah, D.U., Schubel, P.J., Clifford, M.J., 2013. Modelling the effect of yarn twist on the tensile strength of unidirectional plant fibre yarn composites. *J. Compos. Mater.* 47, 425–436. <https://doi.org/10.1177/0021998312440737>.
- Shah, D., Schubel, P., Clifford, M., 2013. Modelling the effect of yarn twist on the tensile strength of unidirectional plant fibre yarn composites. *J. Compos. Mater.* 47, 425–436. <https://doi.org/10.1177/0021998312440737>.
- Shah, D., Nag, N., Clifford, M., 2016. Why do we observe significant differences between measured and ‘back-calculated’ properties of natural fibres? *Cellulose* 23, 1481–1490. <https://doi.org/10.1007/s10570-016-0926-x>.
- Sharma, U.S., 1997. Eco Friendly and Versatile Coir Geotextiles. Geosynthetics Asia congress, India.
- Sharma, S.B., Sutcliffe, M.P.F., Chang, S.H., 2003. Characterisation of material properties for draping of dry woven composite material. *Comp. Part A* 34, 1167–1175.
- Suedstaerke. <http://www.suedstaerke.de/index.php?Starches-for-the-textile-industry> (n.d).
- Szostak-Kotowa, J., 2004. Biodeterioration of textiles. *Int. Biodeterior. Biodegrad.* 53, 165–170.
- Tephany, C., Gillibert, J., Ouagne, P., Hivet, G., Allaoui, S., Soulat, D., 2016. Development of an experimental bench to reproduce the tow buckling defect appearing during the complex shape forming of structural flax based woven composite reinforcements. *Compos Part A Appl Sci Manuf* 81, 22–33. <https://doi.org/10.1016/j.compositesa.2015.10.011>.
- Tomljenovic A, A., Erceg M, M., 2016. Characterisation of textile and oleaginous flax fibrous and shives material as potential reinforcement for polymer composites. *Tekstilec* 59 (3), 350–366.
- Tourlonias, M., Bueno, M.A., 2016. Experimental simulation of friction and wear of carbon yarns during the weaving process. *Compos Part A Appl Sci Manuf* 80, 228–236. <https://doi.org/10.1016/j.compositesa.2015.07.024>.
- Vanclooester, K., Lomov, S.V., Verpoest, I., 2009. Experimental validation of forming simulations on fabric reinforced polymers using an unsymmetrical mould configuration. *Comp. Part A* 40, 530–539.
- Veluraja, K., Ayyalnarayanasubburaj, S., Paulraj, A.J., 1997. Preparation of gum from Tamarind seed — and its application in the preparation of composite material with sisal fibre. *Carbohydr. Polym.* 34, 377–379. [https://doi.org/10.1016/S0144-8617\(97\)00128-8](https://doi.org/10.1016/S0144-8617(97)00128-8).
- Waldrop, M.P., Balsler, T.C., Firestone, M.K., November 2000. Linking microbial community composition to function in a tropical soil. *Soil Biol. Biochem.* 32 (13), 1837–1846.
- Wang, P., Legrand, X., Soulat, D., 2017. Three-dimensional textile preform using advanced textile technologies for composite manufacturing. In: Kumar, B. (Ed.), *Text. Adv. Appl. InTech*, Rijeka. <https://doi.org/10.5772/intechopen.68175>.
- Xie, Y., Oxenham, W., Grosberg, P., 1986. 24—A study of the strength of wrapped yarns part i: the theoretical model. *J. Text. Inst.* 77, 295–304. <https://doi.org/10.1080/00405008608658424>.
- Xie, Y., Oxenham, W., Grosberg, P., 1986. 25—A study of the strength of wrapped yarns part ii: computation and experimental. *J. Text. Inst.* 77, 305–313. <https://doi.org/10.1080/00405008608658425>.
- Xie, Y., Oxenham, W., Grosberg, P., 1986. 26—A study of the strength of wrapped yarns part iii: the relationship between structural parameters and strength. *J. Text. Inst.* 77, 314–326. <https://doi.org/10.1080/00405008608658426>.

- Xue, D., Hu, H., 2013. Mechanical properties of biaxial weft-knitted flax composites. *Mater. Des.* 46, 264–269. <https://doi.org/10.1016/j.matdes.2012.10.019>.
- Xue, D., Miao, M., 2012. Influences of moisture absorption and chemical treatments on the resin flow characteristics of natural fibre nonwoven mats. *J. Text. Inst.* 103, 1024–1030. <https://doi.org/10.1080/00405000.2012.660319>.
- Xue, D., Miao, M., Hu, H., 2011. Permeability anisotropy of flax non-woven mats in vacuum-assisted resin transfer molding. *J. Text. Inst.* 102, 612–620. <https://doi.org/10.1080/00405000.2010.504566>.
- Yan, G., Yu, C., 2007. A joint influence of the distributions of fibre length and fineness on the strength efficiency of the fibres in yarn. *Fibres Polym* 8, 309–312. <https://doi.org/10.1007/BF02877275>.
- Yan, L., Chouw, N., Jayaraman, K., 2014. Flax fiber and its composites – a review. *Compos. B Eng.* 56, 296–317.
- Zhang, L., Miao, M., 2010. Commingled natural fibre/polypropylene wrap spun yarns for structured thermoplastic composites. *Compos. Sci. Technol.* 70, 130–135. <https://doi.org/10.1016/j.compscitech.2009.09.016>.
- Zhang, F., Comas-Cardona, S., Binetruy, C., 2012. Statistical modeling of in-plane permeability of non-woven random fibrous reinforcement. *Compos. Sci. Technol.* 72, 1368–1379. <https://doi.org/10.1016/j.compscitech.2012.05.008>.

Multi-scale mechanical characterization of flax fibres for the reinforcement of composite materials

6

Alain Bourmaud¹, Lucile Nuez^{1,2}, Camille Goudenhoft¹, Christophe Baley¹

¹Université de Bretagne-Sud, IRDL, CNRS UMR 6027, BP 92116, Lorient Cedex, France;

²Van Robaey Frères, Killeem, France

6.1 Introduction

Plant fibres are among the oldest materials found throughout human history. With wool, flax was probably used to make the first textiles in the world. The first trace of flax comes from the identification of 30,000-year-old wild flax fibres in Georgia (Kvavadze et al., 2009). Flax has really accompanied the history of man and the birth of agriculture in the Neolithic (about 10,000 years before our era) in Mesopotamia and throughout the Fertile Crescent (Boquet et al., 1986); it is considered as the first plant domesticated by man. Samples found in ancient lakeside towns in Switzerland were dated to about 8000 BCE. Thus, capsules and balls of retted stems were found in front of houses. Retting through water treatment made it possible to facilitate the division of the flax fibres organized into bundles in the stem, and to clean their surfaces of the residues of adjoining lamellae. It enabled the improvement of the quality of the fibres for textile applications and testified of the technological progress of these ancient civilizations which made water retting one of the oldest known biotechnologies.

From the 6th century BCE, the Egyptians perfected the culture and processing of flax. These fabrics, which had never reached such degrees of fineness before, were used for clothing, for mummy wrapping and, more rarely, for food, seeds having indeed been discovered in the remains of two Egyptians (about 5000 BCE). Egyptian Christians (especially Copts) have perpetuated this flax tradition for many centuries. Pliny the Elder marvelled at the quality of the flax threads and the whole Gaul wove clothes, mattresses and above all sails including those of Alexandre Le Grand's fleet (Mosiniak and Prat, 2002).

The use of flax greatly expanded in Europe during the medieval period; in France, Charlemagne demanded that it be spun to the court and that every home in the empire had the material necessary for its work. The first flax markets were born in Lyon and Rouen around 800. From the 13th century onwards, flax flourished and its quality made Flanders famous. In the 17th century, under Colbert's leadership, flax cultivation successfully spread to Brittany, Normandy, Picardy and Champagne. It was mainly

used to make high-quality canvases that were used as currency for international trade. A real flax route has thus emerged between the Baltic countries (seed producers), France and America. At that time 300,000 ha were devoted to its cultivation in France. Despite its great qualities of finesse and the quality of the fabrics and textiles produced, flax will be dethroned by cotton in the 19th century, cheaper and easier to work (Lourd, 1964). Nevertheless, flax is now less polluting and has a high-quality image that is once again attracting great interest in competing with synthetic fibres, whether in textiles or in the reinforcement of plastics. It is currently the only fibre plant, with hemp, to be grown industrially in a temperate climate (Lourd, 1964).

In 2017, 137,200 tons of flax fibres were produced in Western Europe, representing approximately 140,000 ha; France is the world leader with more than 100,000 ha cultivated in 2017 (Le and français, 2017). Since 2013, the surface area has increased significantly due to ever-increasing demand and attractive financial returns for farmers. Even if the majority of these fibres are intended for textiles, the composite industry consumes a limited but growing fraction of this production. Manufacturers are demanding volumes and reproducible mechanical performances from 1 year to the next, which requires the sector to evolve and to work both on the yields but also on the mechanical properties of flax fibres. The latter can be apprehended at different scales, each of which makes it possible to obtain relevant mechanical information. This chapter proposes a reflection on this characterization, in connection with the specificities and structure of the plant and fibres. Initially, a description of the plant and its structure will emphasize the unusual slenderness of a flax stem and insist on the role of fibres within this structure, especially in terms of stability. The different scales of analysis, stem, bundle, fibre and cell wall will then be described and analyzed; for each of them, the methodology will be discussed as well as the main relevant information that can be obtained. The conclusion will focus on the measurement of fibre stiffness and the choice of the appropriate measurement scale.

6.2 Link between stem structure and fibre performance: flax plant, a model for biomimetics

6.2.1 Description of the flax plant architecture

Fig. 6.1 shows a transverse cross-section of the middle of a flax stem (Fig. 6.1A) as well as the detailed description of the main tissues (Fig. 6.1B) (Baley et al., 2018). One can notice the specific composite structure of the stem with two main constitutive areas: fibre bundles located at the periphery of the stem and the woody core of the plant (mainly xylem) located between the fibres and the central cavity. The flax fibres are linked together by the pectic middle lamella between the primary cell walls of two neighbouring fibres and the tri-cellular junctions in the corner between three fibres (Baley et al., 2014).

Flax fibre growth is finely described in literature. Fibres are formed in a coordinated manner with four distinct steps: (1) fibre cell multiplication at the top of the stem

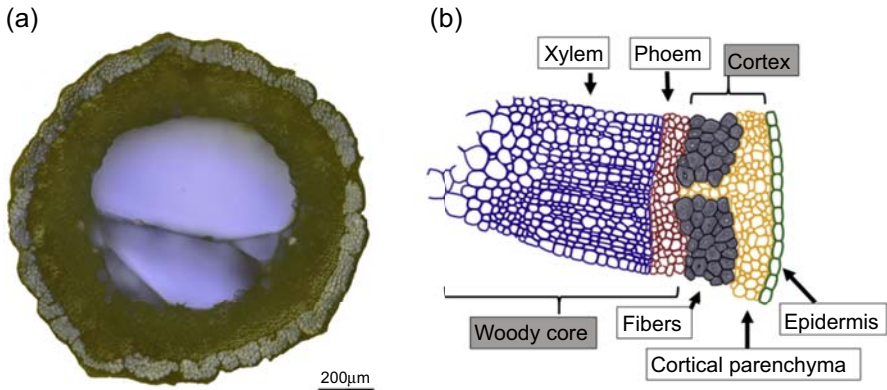

Figure 6.1 Transverse cross-section of the middle of a flax stem (A) and detailed description of the main tissues (B) (Baley et al., 2018).

(Esau, 1977), (2) cell elongation in the top 3–5 cm segment of the stem top, (3) fibre radial expansion and thickening of the walls below the snap point, a zone defined by (Gorshkova et al., 1997) where the stiffness of the stem increases significantly and (4) structuring of the wall leading in some cases to a reduction in the cell wall thickness and consequently fibre diameter (Andème-Onzighi et al., 2000; Snegireva et al., 2006). During the cell elongation which lasts 3–5 days per fibre (Snegireva et al., 2010), the cell extends by around 5–20 mm per day (Ageeva et al., 2005) to reach up to 80 mm (Gorshkova et al., 2003); this intrusive elongation induces the penetration of fibres through the shared lamellae between neighbouring cells (Ageeva et al., 2005) giving cohesive bundles of several tens of fibres. The unusual length of flax fibres is not obtained by classical cellular division but uniquely by multiplication of the nuclei and then by cellular elongation. At the end, each fibre can possess several tens of nuclei (Ageeva et al., 2005).

Interestingly, the work of varietal selection, which aims to increase fibre yield and plant lodging stability, has an impact on the architecture of flax stem (Goudenhooff et al., 2017). By comparing varieties from the 1940s to nowadays, anatomical changes over time can be highlighted, with a pronounced decrease of the existing gap between fibre bundles and an increase of the amount of fibres. Current varieties such as the French variety Aramis, at the middle height of the stem, are made up of 1361 ± 99 fibres per section, representing 13.4% of the tissue area (Goudenhooff et al., 2017).

6.2.2 Slenderness and stability of flax

In the plant world, flax is a unique model of slenderness (Goudenhooff et al., 2019a); it displays an outstanding ratio between stem height and diameter, particularly in comparison with other herbaceous plants (Fig. 6.2). This gives it an extraordinary vertical stability attributed to the stem architecture that can be compared to a sandwich composite material. To simplify, the two main tissue zones are those of fibres and woody

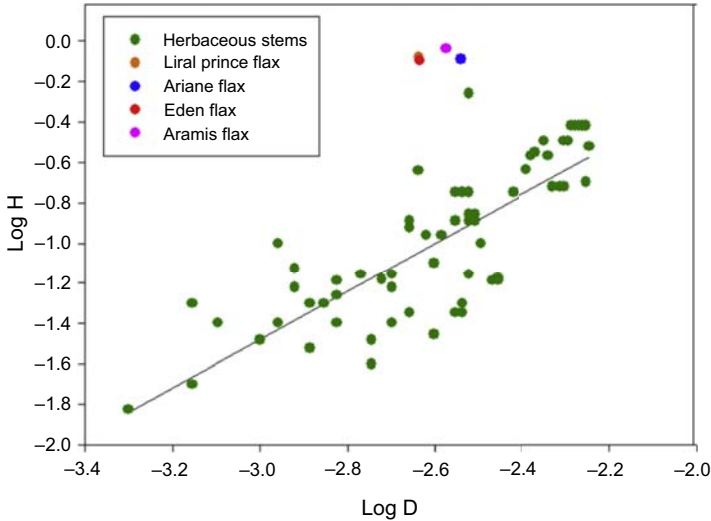

Figure 6.2 Scaling relationship for plant height (L) and basal diameter (D) measured on flax (*Linum usitatissimum* L.) compared with herbaceous plants analyzed by Niklas (1995).

core. As will be detailed later in this chapter, the elementary fibres have excellent mechanical performances and, in the plant, they are located in the periphery, aligned in the axis of the stem with a very important volume fraction ($\sim 90\%$ -vol of the fibre crown) (Baley et al., 2018). These fibres are linked together by a very cohesive pectic matrix giving the system optimal interfaces. They thus form an optimized and high performance unidirectional composite.

Moreover, the woody part of the plant is a cellular structure with a vascular role; this light structure can be assimilated to the core of the sandwich composite mentioned before. Its geometry greatly reduces micro-buckling and ovalization of the stems during bending as is the case during a lodging episode (Schulgasser and Witztum, 1992); it is very complementary with the stiffness provided by the fibre crown. Thus, the flax stem is an optimized composite structure designed to display unequalled performances in terms of flexural strength, which allow the plant to present an outstanding slenderness and to be a source of inspiration for future composite materials.

6.3 Multi-scale mechanical characterization of flax

To introduce this section, Fig. 6.3 proposes a summary of the various mechanical data that can be obtained at the various investigation scales. Whatever scale of experimental testing, a large range of the fibre mechanical properties can be obtained; some of them can be calculated by different routes. The following sections present the four specific approaches, focusing on both experimental points and pertinence of the data obtained.



Testing mode	Data
 Stem bending testing	$E_{FL}, \epsilon_{FL}^-, \sigma_{FL}^-$
 Bundle tensile testing	E_{FL}, τ_{ML}
 Single fibre tensile testing	Stress-strain curve, $E_{FL}^+, \sigma_{FL}^+, \epsilon_{FL}^+$
 Cell wall testing; Nanoindentation / AFM	$E_{FLnano}, E_{FTnano}, H_{nano}$

Figure 6.3 Synthesis of mechanical data potentially obtained through multi-scale mechanical characterization (Bourmaud et al., 2019b). *E*, Modulus; *F*, fibre, *H*, hardness, *L*, longitudinal; *ML*, middle lamella; *Nano*, nanoindentation; *T*, transverse; ϵ , Elongation; σ , strength; τ , shearing strength.

6.3.1 Mechanical investigations on stems: an innovative way to obtain fibre performances

6.3.1.1 Bending tests on flax stems: generalities and experimental parameters

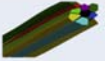
Generalities

In nature, an excessive bending moment frequently causes the failure of plant stems (Shah et al., 2017), including flax, which typically yields by local buckling (Spatz et al., 1990). Bending tests are current and common methods for the mechanical characterization of plant stems and for the investigation on their resistance towards bending. Nevertheless, no standards are available for the testing of these biological materials. Several types of bending tests are presented in literature, all providing information about the bending strength and elastic modulus of the plant (Shah et al., 2017). Namely cantilever (Caliaro et al., 2013), three-point (Réquilé et al., 2018) and four-point (Robertson et al., 2015) bending tests can be used; yet, three-point bending tests are the most common methods of mechanical characterization performed on plant stems (Réquilé et al., 2018; Goodman and Ennos, 1996; Leblicq et al., 2015; Robertson et al., 2016).

Three-point bending test – set-up for testing of a flax stem

In the case of a three-point bending test, the stem sample is placed on two supports without clamping and the largest bending deflection is located at mid-span, where the force is usually applied (Fig. 6.4).

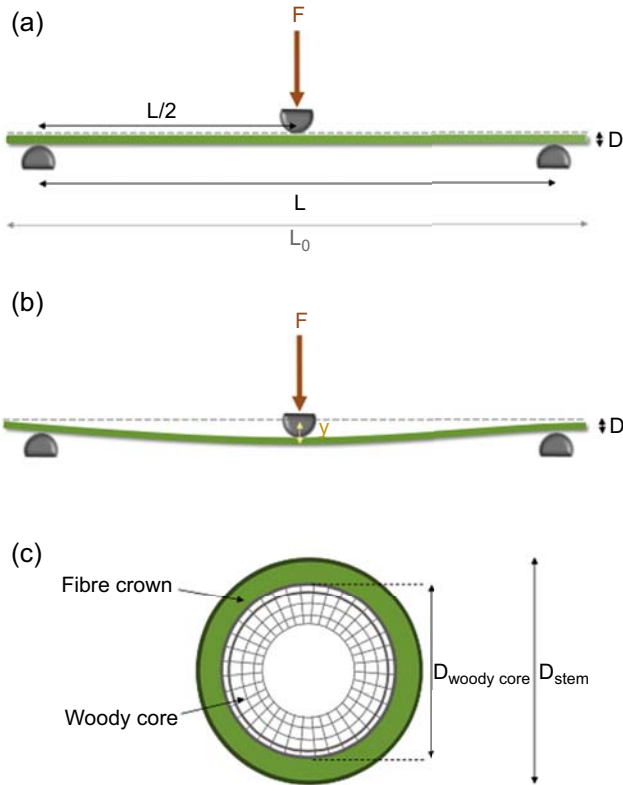

Figure 6.4 Set-up for a three-point bending test of a flax stem. (A) At the beginning of the test. (B) During the experiment on flax straw. (C) Transverse cross-section of a flax sample. F is the applied force, L_0 is the sample length, L the span length, D is the sample diameter (being either D_{stem} the diameter of the whole stem or $D_{\text{woody core}}$ the diameter of the sample devoid of fibres), and y the displacement in the middle of the sample section.

By considering the plant sample as a uniform beam with a circular cross-section, the displacement y in the sample centre at mid-span is given by Eq. (6.1), for small displacements (Timoshenko, 1947):

$$y = \frac{FL^3}{48EI} \quad (6.1)$$

where, F is the applied force, L the span length and EI the bending stiffness, I the quadratic momentum given as $I = \frac{\pi}{64}D^4$ and E the bending modulus of the cylindrical sample.

The stem bending stiffness EI is then obtained by applying Eq. (6.2):

$$EI = \frac{dF}{dy} \frac{L^3}{48} \quad (6.2)$$

where, dF/dy is the slope of the linear part of the force–displacement curve.

Finally, by evaluating the quadratic momentum I of the sample, its bending modulus E can be calculated.

Three-point bending test – experimental parameters

To obtain accurate data on stem bending properties, careful attention must be given to the set-up parameters. Three-point bending tests on plant samples should be carried out under a standard atmosphere for comparison, commonly at 23.0 ± 2.0 °C and a relative humidity of $50.0 \pm 4.0\%$ (ISO 139:2005). The crosshead speed must be determined to minimize viscoelastic effects; it is usually fixed at 0.1 mm/s for flax samples (Réquillé et al., 2018; Goudenhooff et al., 2019b). Moreover, the stem sample must be slender enough to minimize the contribution of shearing, this latter being known to underestimate sample mechanical properties (Shah et al., 2017). Thus, the span-to-depth ratio LD_{ext} must be carefully selected. For the experiments carried out on dried flax stems, an LD_{ext} ratio of 80 (i.e. L of 18 cm for an average sample diameter D_{ext} of 2.25 mm) is chosen (Fig. 6.5) (Réquillé et al., 2018), which is much higher than values typically chosen in literature regarding other plants (LD_{ext} usually ranges from 10 to 40, as larger LD_{ext} are often limited by the presence of nodes or by sagging of non-rigid stem samples) (Shah et al., 2017).

Additionally, increasing the LD_{ext} ratio together with using rounded anvil (and supports) reduces the risk of ovalization of the section at the loading point (Robertson et al., 2015), ovalization which reduces resulting stem mechanical properties (Leblicq et al., 2015).

6.3.1.2 Use of bending tests to estimate fibre stiffness

Hypothesis

The stem is assimilated to a composite tube of two layers: the fibre crown and the woody core (Fig. 6.1A,B). If only fibres are assumed to contribute to the bending

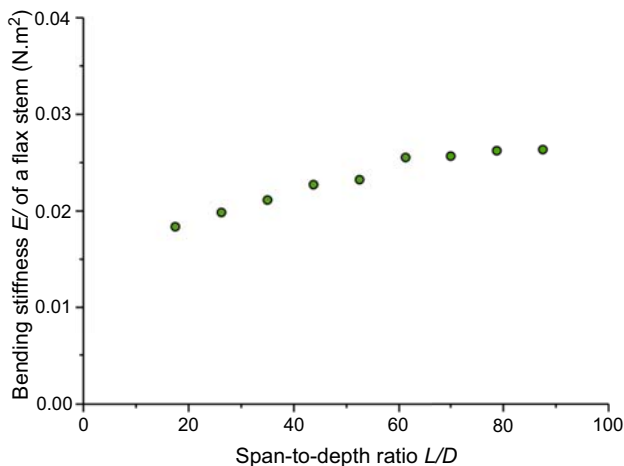

Figure 6.5 Influence of the span-to-depth ratio on the stiffness measurement of flax stems (Réquillé et al., 2018).

stiffness within peeled tissues, the bending stiffness of the entire stem is obtained by adding the bending stiffness of each layer, i.e. $(EI)_{\text{stem}} = (EI)_{\text{fibres}} + (EI)_{\text{woody core}}$.

Being assimilated to beams with a circular cross-section, the bending stiffness of both the entire stem and the woody core (i.e. peeled stem devoid of fibres) can be estimated using Eq. (6.2). Finally, the apparent fibre modulus E_{fibres} can be estimated by Eq. (6.3):

$$E_{\text{fibres}} = \frac{(EI)_{\text{stem}} - (EI)_{\text{woody core}}}{I_{\text{fibres}}} \quad (6.3)$$

where, I_{fibres} is the quadratic momentum of the fibre crown, expressed as $I_{\text{fibres}} = \frac{\pi}{64} (D_{\text{stem}}^4 - D_{\text{woody core}}^4)$.

Evaluation of the fibre modulus obtained by bending tests

The common method found in literature to estimate the mechanical properties of flax fibres is NFT 25-501-2 (AFNOR NF T 25-501-2, 2015), i.e. tensile tests on elementary fibres. This method is very time-consuming but also requires fine equipment and rather skilled experimenters. To validate the method used for estimating fibre modulus from stem bending tests, the results were compared with the elementary fibre modulus measured by tensile tests (Fig. 6.6). Bolchoï variety, a French cultivar from Terre de Lin, was used for these investigations.

Despite a wide scattering of fibre moduli, similar values are obtained for both types of experiments, namely an average tangent modulus reaching 54.7 ± 13.2 GPa by tensile tests and a modulus of 55.8 ± 14.5 GPa estimated by bending tests (Réquillé

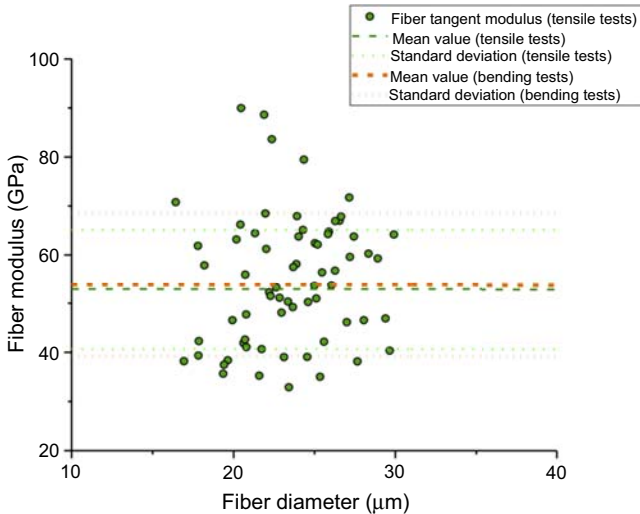

Figure 6.6 Modulus measured by tensile test on single Bolchoï flax fibres. Compared with average fibre modulus value estimated by bending tests (Réquillé et al., 2018).

et al., 2018). Thus, the fibre modulus can be effectively related to the stiffness of the stem; three-point bending tests on stems are expected to become a standard method for estimating the apparent modulus of flax fibres.

6.3.2 Tensile tests on flax fibre bundles: characterization of inter fibre interfaces

6.3.2.1 Choice of pertinent parameters for tensile testing of flax fibre bundles

Influence of the measure of cross-section diameter on the tensile behaviour of flax bundles

Like elementary fibres, the protocol for tensile tests on technical fibres, i.e. groups of fibres either in complete or partly divided bundles (Alix et al., 2012), has been standardized (NFT 25-501-3 (AFNOR NF T 25-501-3, 2015)), but parameters such as testing speed, gauge length and measure of the cross-section area (CSA) vary in the literature. The tensile properties depend on the fibre CSA; therefore, its accurate measurement is essential. The mean apparent diameter of the fibre bundle is often evaluated by optical microscope as it is for elementary fibres (Stamboulis et al., 2000). Flatbed scanning applies the same principle, but a high resolution of scan is essential to obtain precise measurements (Haag, 2016). Several variations exist; for example, Bos (2004) measured the apparent diameter in two perpendicular directions twice along the fibre bundle, and approximated the smallest measure as a rectangle and the other as a circle. Indeed, the obstacle lies in the fact that a fibre bundle cross-section is roughly elliptical (Grishanov et al., 2006) and approximations of the diameter as circular induce lower strength values than reality. This also causes higher dispersion in the values related to the bundle mechanical properties. Haag (2016) compared the tensile properties of 50 fibre bundles for which the CSA had previously been measured by three non-destructive techniques (microscopy, flatbed scanner, and laser-based Fibre Dimensional Analysis System (FDAS)) and the diameter was then calculated by four different methods (circular, elliptic, SEM-based and FDAS). The study reveals 300% of dispersion in the results, of which 180% dispersion are due to the different calculation methods, and 175% to the measurement technique. This demonstrates why the tensile properties of flax bundles found in the literature may be remarkably different.

More precise methods include direct assessment of the CSA by optical microscopy and image analysis, as it may be applied after the tensile test by two measures taken at the attached extremities of the bundle to the support (Barbulée, 2015). Although the measure of the CSA is precise, it does not take into account its potential diameter variations along the tested bundle, and the main drawback is that it is time consuming and therefore inappropriate for industrial purposes. FDAS determines the diameter by 360 degrees rotation around and along the bundle. The main advantage of this method is its high reproducibility in measurement and image generation, although it does not take into account the potential concavity of the bundle, and it requires an important investment beforehand (Haag, 2016).

In the textile industry, fineness is measured as a lineic mass, in tex (1 tex = 1 g/km), therefore tenacity (N/tex) may be evaluated rather than tensile strength (Baiardo et al., 2004). Another approach is to estimate the CSA by dividing the lineic mass by the fibre density, which is usually of approximately 1.5 g/cm³ (Thygesen et al., 2011). This method is often adopted when tows or larger bundles of flax are characterized for its rapid assessment (Moothoo, 2014; Velde and Baetens, 2001).

Influence of the gauge length

An important parameter to be considered when testing technical fibres is the gauge length. Indeed, the length of elementary fibres ranges from 4 to 77 mm, with a mean length of around 33 mm (Baley, 2002). Therefore, when the gauge length is above that of the elementary fibres, failure occurs through the pectin interphase by axial splitting or debonding during the first instance (Romh ny et al., 2003). As the gauge length decreases, the distribution of elementary fibre lengths and the number of critical defects decrease as well. This triggers a behaviour close to that of the elementary fibre as failure takes place directly through the cellulosic cell wall of the individual fibres (Bos, 2004). Therefore, the tensile properties of technical fibres tend to decrease when gauge lengths increase, as shown in Fig. 6.7.

It's always delicate to compare data obtained from different testing conditions (flax variety, tested volume, loading rates, etc.), but the same tendency is evidenced on single fibres; Baley and Bourmaud (2014) measured the elementary fibre mean tensile strength of 12 flax varieties at 945 ± 200 MPa for a 10 mm gauge length, while Bos (2004) obtained values above 1500 MPa for a 3 mm gauge length. For both fibres

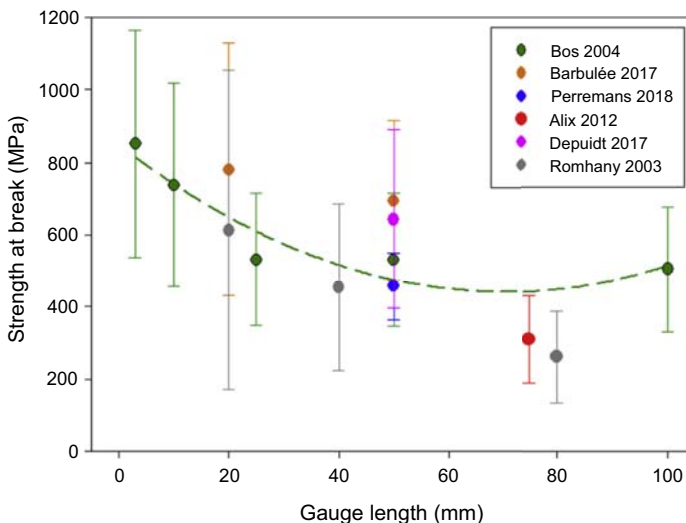

Figure 6.7 Tensile strength of flax bundles as function of gauge length (Alix et al., 2012; Bos, 2004; Romh ny et al., 2003; Barbul e and Gomina, 2017; Perremans et al., 2018; Depuydt et al., 2017).

and bundles, the rise in gauge length increases the number of weak elements such as kink bands; in the case of tests on bundles, the probability to characterize fibre–fibre interfaces and not fibre properties is also naturally increased. Further details on the mechanical properties of elementary flax fibres are given in a next section.

6.3.2.2 *Evaluation of the elementary fibre cohesion within a bundle*

Decohesion mechanisms

The decohesion mechanisms of flax fibre bundles can be studied by correlating between tensile testing and acoustic emission (AE). [Romhany et al. \(2003\)](#) noticed that low AE amplitudes occurred during the initial fracture, whereas high amplitude signals were received at the final fracture of the fibres. Correlation was made between AE and observations of a fibre bundle under tensile stress by scanning electron microscope (SEM). Three successive decohesion modes were revealed ([Romhány et al., 2003](#)). Furthermore, [Barbulée et al. \(2014\)](#) conducted AE and tensile tests on flax slivers, i.e. bundles associated with bast tissues. Damage accumulation in the sliver was evaluated as the density of broken fibres. Three populations of damage mechanisms were identified by reason of multiple AE parameters: friction among ultimate fibres of fibre bundles and rupture of ultimate fibres; delamination among or within fibre bundles and partial ruptures of fibre bundles; and catastrophic rupture of the fibres bundles.

Influence of process on cohesion between elementary fibres

Testing the tensile properties at the level of a flax fibre bundle delivers a valuable evaluation of the effects of physical or chemical action on elementary fibre cohesion. [Charlet and Béakou \(2011\)](#) evaluated the shearing properties at the fibre–fibre interface of previously retted, scutched and hackled flax by statistically estimating the contact area between two contiguous fibres. The tensile tests revealed a mean shear modulus (maximum force divided by the surface of contact) of 2.9 MPa, which is at least twice lower than that of fibre–matrix interfaces that may range from 6 to 33 MPa depending on the materials used ([Joffe et al., 2003, 2005](#); [Coroller et al., 2013](#)). In the intention of processing flax reinforced composites, the fibre–matrix interface is a major parameter to determine the compatibility and therefore the future mechanical properties of the composite. This result shows the importance of individualization of the flax fibres so as to optimized fibre–matrix cohesion.

The retting degree may also be assessed by bundle tensile tests. [Velde and Baetens \(2001\)](#) investigated the evolution of the tensile properties of green, under retted and normally retted flax, first scutched then hackled. Tensile strength values ranged from 719 to 930 MPa, with lower values corresponding to green flax. [Alix et al. \(2012\)](#) noticed no significant difference in the failure strength between green and field retted flax, with values slightly above 300 MPa. Alix et al. also carried out multiple studies on the effects of enzyme retting ([Alix et al., 2012](#)), and well as the effect of chemical treatments and moisture regain on the tensile properties of flax bundles ([Alix et al., 2009](#)).

Finally, the effect of the different processing steps on the individualization of flax fibres can be identified by tensile tests on technical fibres. Thygesen et al. (2011), evaluated the effect of single or double mechanical cottonization on the mechanical properties of flax fibre bundles that had previously been dew-retted, scutched, carded and mechanically broken down to 2–5 cm fibres. Results are given in fracture strength by a given bundle surface of 0.10 mm^2 , and values drop from $482 \pm 24 \text{ MPa}$ for dew-retted, scutched and carded flax to 338 ± 22 and $238 \pm 28 \text{ MPa}$ for flax that had, furthermore, been cottonized once and twice respectively. This indicates the mechanical effect of the cottonization processing step which separates fibre bundles into individual fibres by breaking down the cohesive middle lamellae between elementary fibres. Nevertheless, tensile tests at the level of the fibre bundle do not deliver precise information on the tensile properties of elementary fibres as cohesion is present between the individual fibres; therefore, further tests are needed to obtain mechanical properties at the plant cell level.

6.3.3 Tensile behaviour of elementary flax fibres: specificity and link with cell wall structure

6.3.3.1 Impact of fibre morphology and diameter measurement on tensile properties calculation

Experimental tensile testing is highly dependent on a large range of intrinsic and exogenous parameters; among these parameters, the estimation of the diameter is probably the most discussed and controversial. Generally the single fibre tensile modulus or strength are shown to decrease when the fibre diameter increases (Andersons et al., 2005; Charlet et al., 2007); which is commonly explained by the Griffith's theory (Griffith, 1921) in link with the probability of the presence of a critical defect increases, inducing a precocious fibre failure (Beaugrand and Guessasma, 2015). In the literature, the diameter dependence of the fibre mechanical properties is also attributed to an over-estimation of their effective CSA, and consequently to uncertainty about the diameter measurement which was estimated to be responsible for 78% of Young's modulus uncertainty and 93% of strength at rupture uncertainty (Lefeuvre et al., 2014). To avoid this issue, viable solutions are to increase the number of measurement points along the fibre, six spots being a reliable value, or to measure the fibre diameter after the tensile test in the breakage area, even if this method is not totally satisfying (Duval et al., 2011; Charlet et al., 2009). As previously discussed in the bundle section, a number of authors proposed experimental alternatives for CSA estimations (Thomason et al., 2011; Haag and Müssig, 2016) even if for single flax fibres, the measurement error is less pronounced than for bundles, due to the more regular shape of elementary flax fibres (Charlet et al., 2010). For example, the average cell form factor (CFF) of flax fibres is included between 0.9 and 1 corresponding to hexagonal and circular shapes respectively (Alix et al., 2009), whereas it is around 0.7 for hemp (Marrot et al., 2013) due to pronounced discrepancy into hemp fibre shape.

In addition, the lumen size considerably varies according to the plant species; in the case of flax, the lumen represents only a small percent of the fibre section (Pickering et al., 2015) and if no meteorological or environmental stress (such as drought or lodging episode (Bourmaud et al., 2015a)) occurs during plant growth, the quite complete cellulose filling of the cell is generally reached. The same variation can arguably be hypothesized for lignocellulosic fibres of other botanical origins. Even so, the majority of authors chooses to optically measure the fibre diameter by CSA calculation, both for the speed and simplicity of measurement, but also by considering that within a composite, the whole fibre (including lumen) must be taken into consideration and represent the real reinforcement object which is not only limited to the cell walls.

6.3.3.2 *Tensile behaviour of elementary flax fibres*

For long single fibres such as flax, tensile characterization is possible. The experimental conditions as well as the tensile properties calculations are detailed in the NFT 25-501-2 standard (AFNOR NF T 25-501-2, 2015) dedicated to the characterization of flax elementary fibres. Due to the complex and hierarchical structure of a flax fibre, made of several layers having specific biochemical constitution and cellulose micro-fibrillar orientation, its response to tensile stress is governed by interactions and interfaces between the cell wall layers. The stress–strain curve of a single flax fibre has been found to display three types of tensile behaviours (Lefeuvre et al., 2014) (Fig. 6.8). Type I (TI) exhibited a linear relationship similar to that observed for glass fibres. Type II (TII) was non-linear and characterized by two distinct sections with a decreasing slope in the second section.

Type III (TIII) has been reported in the literature as being the typical behaviour for an elementary flax fibre (Baley, 2002). It typically exhibits non-linearity with a stiffening effect after a threshold point due to micro-fibril reorientation during tensile loading (Lefeuvre et al., 2014) (Fig. 6.9B). For TIII fibres, the value of the tangent modulus (designated as E_{T3} for type III behaviour) decreases to a minimum (named $E_{I_{T3}}$) then increases up to a plateau before rupture (named $E_{R_{T3}}$). Lefeuvre et al. (2014) studied these specific behaviours and compared several flax batches over three different cultivation years. They suggested that structuring pectin parietal components, enabling links between cellulose micro-fibrils, were more related to the first non-linear section of the stress–strain curve whereas the matrix polysaccharides, in which cellulose micro-fibrils are embedded, could influence the second section of the stress–strain curve in which the tangent modulus increases, by favouring sliding of the microfibrils. The NFT 25-501-2 standard (AFNOR NF T 25-501-2, 2015) recommends the calculation of the fibre longitudinal modulus in the last part of the stress–strain curve, after the micro-fibril loading and partial realignment phase. Thus, tensile tests on single fibres enable to obtain relevant mechanical data which are especially useful for designers and modellers. Elementary plant fibres are the basic reinforcement elements within a biocomposite and an accurate knowledge of their properties is preponderant for the development of the former.

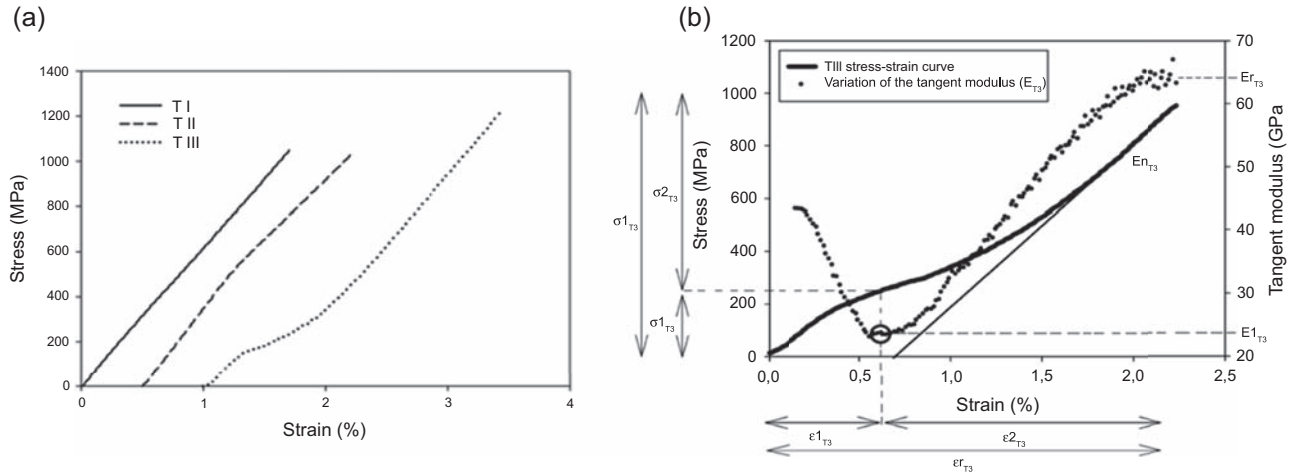

Figure 6.8 3 different types of stress–strain curves of flax (A) elementary fibres and focus on the specific behaviour of TIII behaviour (C). Adapted from Bournaud, A., Beaugrand, J., Shah, D.U., Placet, V., Baley, C., 2018. Towards the design of high-performance plant fibre composites. *Prog. Mater. Sci.* 97, 347–408. doi:10.1016/j.pmatsci.2018.05.005.

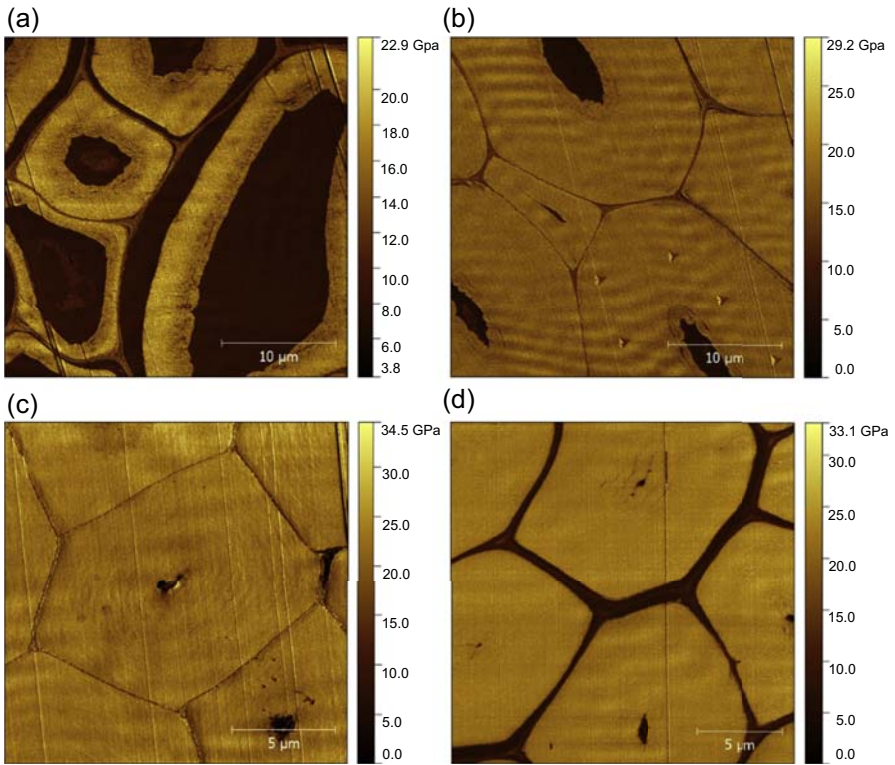

Figure 6.9 AFM PF-QNM modulus mapping of growing (A), mature (B), thermal treated (C) and retted flax fibres (D) (Siniscalco et al., 2018; Bourmaud et al., 2019a).

6.3.4 Nanomechanical investigations on flax cell walls by nanoindentation and AFM

6.3.4.1 Investigations using nanoindentation

In the last 20 years, the development of nanoindentation opened a new way to mechanically characterize the cell walls of plant fibres. Various studies have shown the relevance of this performing tool for studying flax cell walls (Bourmaud and Baley, 2012; Bourmaud et al., 2016; Le Duigou et al., 2015). It can be used to determine the longitudinal indentation modulus of the cell wall but it is also one of the rare experimental methods to obtain a direct value of the transverse stiffness of plant fibres (Bourmaud and Baley, 2009). Nevertheless, for flax, the longitudinal indentation modulus is generally between 17 and 22 GPa, whereas in a tensile test on elementary fibres, the average value of the apparent modulus of the fibre is around 50 GPa (Baley and Bourmaud, 2014). In nanoindentation, tests are performed with a Berkovich-type indenter loading the wall at an angle of approximately 25 degrees. Thus, a complex loading condition exists under the indenter that yields a reduced modulus that depends not only on the longitudinal modulus but also on the (lower) shear and transverse moduli

(Jäger et al., 2011). Indeed, flax fibres are highly anisotropic, and their transverse modulus is estimated to be 8 GPa (Baley et al., 2006). Thus, even if the indentation modulus data cannot be viewed as absolute values, this method enables comparisons of cell wall stiffness, and shows differences between species (Bourmaud and Baley, 2009), cell wall structure, or position within a stem (Marrot et al., 2013; Bourmaud and Baley, 2012). Nanoindentation measurements provide both hardness and stiffness values; as assumed by Konnerth et al. (2009), Gindl et al. (2004) but also Gindl et al the hardness behaviour is dominated by polymers constituting the polysaccharide cell matrix, i.e. hemicelluloses and pectins. In contrast, the nanoindentation modulus is more linked to the properties of cellulose and to the micro-fibrillar angle.

Nanoindentation is a powerful tool that can be used to determine the in situ mechanical properties of composite fibres without any extraction or damage to the material. Thus, nanoindentation measurements can be performed to monitor cell wall properties after processing (Doumbia et al., 2015; Bourmaud et al., 2015b) or along recycling cycles (Bourmaud et al., 2016; Gourier et al., 2017).

To improve the accuracy of nanoindentation measurements, indentation positions can be controlled through atomic force microscopy (AFM) measurements (Bourmaud et al., 2016; Konnerth et al., 2009; Beaugrand et al., 2014). This original coupling can provide suitable information about viscoelastic parameters of flax cell walls, by monitoring both the surface displacement during the recovery phase and the indent size after testing (Keryvin et al., 2015). Similarly, Tanguy et al. (2016) evidenced indentation depth differences between flax and jute due to the specific microstructure of the 2 cell walls and especially their microfibrillar angle.

6.3.4.2 Investigations by AFM

To increase the fineness of mechanical properties investigations on cell walls, AFM measurements can also be performed. First experiments were developed in 1996 by Yamanaka and Nakano (1996) and Rabe et al. (1996) on wood cell walls and the method was optimized by Clair et al. (2003) and Nair et al. (2010) by using 'resonant contact-AFM' (RC-AFM). The new Peak Force Quantitative Nano Measurement (PF-QNM) mode is able to provide fine and well-defined cartography of cell wall stiffness. Some examples are given Fig. 6.9 on flax cell walls to explore the cell wall indentation modulus on growing (A), mature (B), thermal treated (190°C during 8 min) (C) or retted flax fibres (D) (Siniscalco et al., 2018; Bourmaud et al., 2019a).

In both nanoindentation and AFM techniques, the quality of the results is highly dependent on sample surface preparation. It has been shown that a fine polishing enabled better AFM measurements compared to microtome sections. Nevertheless, this conclusion must be moderated, as with optimal blade and preparation conditions, microtome cuts provide reliable and qualitative AFM PF-QNM mode imaging (Arnould et al., 2017).

Whether in nanoindentation or AFM, elastic properties of plant cell walls can be estimated and compared. Thanks to these two powerful tools, fine parietal stiffness according to the variety, the biochemical structure network or the thermo-mechanical stress suffered by fibres can be ascertained, providing new information for the understanding of the cell wall mechanical behaviour in link with the parietal structure.

6.4 Conclusion

This chapter aims to propose a complete synthesis, possibly useful for both academic and industrial researchers, for the investigation, at different scale of cell wall and fibres mechanical behaviour and properties. All the testing methods described in this chapter enable to obtain stiffness values on flax fibres but also on bast plant fibres such as hemp or nettle; however, according to the scale, the resulting values do not have the same meaning.

Thanks to its model structure, a flax stem can easily be bending tested and, knowing the arrangement and fraction of fibres, their modulus can be finely estimated. Results show that the acquired values with this efficient method are reliable and well correlated with fibre apparent modulus obtained by single flax fibre tensile tests. This original and poorly used is very promising and open new perspectives, possibly useful for both academic and industrial laboratories.

Longitudinal modulus can also be measured through tensile characterization of bundles but due to the discontinuity of flax fibres, results are sometimes difficult to analyze, as they also represent the interfacial behaviour of middle lamellae. Attention must be paid to middle lamellae structure, preliminary treatments and fibres morphology, according to these parameters, results and analysis could strongly vary.

With the development of local investigation methods such as AFM and nanoindentation, cell wall longitudinal stiffness can also be measured using this equipment. Although similar stiffness values are obtained by nanoindentation and AFM mapping, the specific geometry of the tips and the compressive loading mode provide underestimated results of the longitudinal cell wall stiffness due to the high plant fibre anisotropy. However, a correlation can be made between tensile tests and indentation results to estimate the stiffness of fibres that are too short for tensile measurements.

Thus, it is possible to determine the plant fibre cell wall stiffness by using different investigation techniques at the macro-, micro- or nano-scale. Nevertheless, at the composite scale, the tensile method is best and the more reliable to obtain the whole fibre apparent tangential modulus. According to the know-how of the experimenter, available equipment or preparation modes, alternative method may be used, but the scientist has to keep in mind the real sense of both experimental ways and investigation scale.

References

- AFNOR NFT 25-501-2, 2015. Reinforcement fibres- Flax fibres for plastics composites. In: Part 2. Determination of Tensile Properties of Elementary Flax Fibres. AFNOR Edition in French.
- AFNOR NF T 25-501-3, 2015. Reinforcement Fibres- Flax Fibres for Plastics Composites. Part 3. Determination of Tensile Properties of Technical Fibres (in French).
- Ageeva, M.V., Petrovská, B., Kieft, H., Sal'nikov, V.V., Snegireva, A.V., Dam, J.E.G., et al., 2005. Intrusive growth of flax phloem fibers is of intercalary type. *Planta* 222, 565–574. <https://doi.org/10.1007/s00425-005-1536-2>.

- Alix, S., Philippe, E., Bessadok, A., Lebrun, L., Morvan, C., Marais, S., 2009. Effect of chemical treatments on water sorption and mechanical properties of flax fibres. *Bioresour. Technol.* 100, 4742–4749.
- Alix, S., Lebrun, L., Marais, S., Philippe, E., Bourmaud, A., Baley, C., et al., 2012. Pectinase treatments on technical fibres of flax: effects on water sorption and mechanical properties. *Carbohydr. Polym.* 87, 177–185. <https://doi.org/10.1016/j.carbpol.2011.07.035>.
- Andème-Onzighi, C., Girault, R., His, I., Morvan, C., Driouich, A., 2000. Immunocytochemical characterization of early-developing flax fiber cell walls. *Protoplasma* 213, 235–245. <https://doi.org/10.1007/bf01282161>.
- Andersons, J., Sparnins, E., Joffe, R., Wallström, L., 2005. Strength distribution of elementary flax fibres. *Compos. Sci. Technol.* 65, 693–702.
- Arnould, O., Siniscalco, D., Bourmaud, A., Le Duigou, A., Baley, C., 2017. Better insight into the nano-mechanical properties of flax fibre cell walls. *Ind. Crops Prod.* 97, 224–228. <https://doi.org/10.1016/j.indcrop.2016.12.020>.
- Baiardo, M., Zini, E., Scandola, M., 2004. Flax fibre – polyester composites. *Compos - Part A Appl Sci Manuf* 35, 703–710. <https://doi.org/10.1016/j.compositesa.2004.02.004>.
- Baley, C., 2002. Analysis of the flax fibres tensile behaviour and analysis of the tensile stiffness increase. *Compos Part A Appl Sci Manuf* 33, 939–948.
- Baley, C., Bourmaud, A., 2014. Average tensile properties of French elementary flax fibers. *Mater. Lett.* 122, 159–161. <https://doi.org/10.1016/j.matlet.2014.02.030>.
- Baley, C., Perrot, Y., Busnel, F., Guezenc, H., Davies, P., 2006. Transverse tensile behaviour of unidirectional plies reinforced with flax fibres. *Mater. Lett.* 60, 2984–2987.
- Baley, C., Le Duigou, A., Bourmaud, A., Davies, P., Nardin, M., Morvan, C., et al., 2014. Reinforcement of polymers by flax fibers: role of interfaces. *Bio-Based Compos. High-Performance Mater.* CRC Press, pp. 87–112. <https://doi.org/10.1201/b17601-7>.
- Baley, C., Goudenhoft, C., Gibaud, M., Bourmaud, A., 2018. Flax stems: from a specific architecture to an instructive model for bioinspired composite structures. *Bioinspiration Biomimetics* 13, 026007. <https://doi.org/10.1088/1748-3190/aaa6b7>.
- Barbulée, A., 2015. Compréhension des effets du défibrage sur la morphologie, les propriétés et le comportement mécanique des faisceaux de fibres de lin. Etude d'un composite dérivé lin-époxyde.
- Barbulée, A., Gomina, M., 2017. Variability of the mechanical properties among flax fiber bundles and strands. *Procedia Eng* 200, 487–493. <https://doi.org/10.1016/j.proeng.2017.07.068>.
- Barbulée, A., Jernot, J.-P., Bréard, J., Gomina, M., 2014. Damage to flax fibre slivers under monotonic uniaxial tensile loading. *Compos Part A Appl Sci Manuf* 64, 107–114. <https://doi.org/10.1016/j.compositesa.2014.04.024>.
- Beaugrand, J., Guessasma, S., 2015. Scenarios of crack propagation in bast fibers: combining experimental and finite element approaches. *Compos. Struct.* 133, 667–678.
- Beaugrand, J., Nottez, M., Konnerth, J., Bourmaud, A., 2014. Multi-scale analysis of the structure and mechanical performance of woody hemp core and the dependence on the sampling location. *Ind. Crops Prod.* 60, 193–204. <https://doi.org/10.1016/j.indcrop.2014.06.019>.
- Boquet, A., Caillat, R., Lunstrombais, K., 1986. Alimentation et technique de cuisson dans le village de Charavine, Isère. In: Picard (Ed.), *Le néolithique la Fr.*, pp. 319–328.
- Bos, H.L., 2004. The Potential of Flax Fibres as Reinforcement for Composite Materials. Technische Universiteit Eindhoven.

- Bourmaud, A., Baley, C., 2009. Rigidity analysis of polypropylene/vegetal fibre composites after recycling. *Polym. Degrad. Stab.* 94, 297–305. <https://doi.org/10.1016/j.polymdegradstab.2008.12.010>.
- Bourmaud, A., Baley, C., 2012. Nanoindentation contribution to mechanical characterization of vegetal fibers. *Compos. B Eng.* 43, 2861–2866. <https://doi.org/10.1016/j.compositesb.2012.04.050>.
- Bourmaud, A., Gibaud, M., Lefevre, A., Morvan, C., Baley, C., 2015. Influence of the morphology characters of the stem on the lodging resistance of Marylin flax. *Ind. Crops Prod.* 66, 27–37. <https://doi.org/10.1016/j.indcrop.2014.11.047>.
- Bourmaud, A., Corre, Y.-M., Baley, C., 2015. Fully biodegradable composites: use of poly-(butylene-succinate) as a matrix and to plasticize l-poly-(lactide)-flax blends. *Ind. Crops Prod.* 64, 251–257. <https://doi.org/10.1016/j.indcrop.2014.09.033>.
- Bourmaud, A., Akesson, D., Beaugrand, J., Le Duigou, A., Skrifvars, M., Baley, C., 2016. Recycling of L-Poly-(lactide)-Poly-(butylene-succinate)-flax biocomposite. *Polym. Degrad. Stab.* 77–88. Available:77–88. <https://doi.org/10.1016/j.polymdegradstab.2016.03.018>.
- Bourmaud, A., Siniscalco, D., Foucat, L., Goudenhoofft, C., Falourd, X., Pontoire, B., et al., 2019. Evolution of flax cell wall ultrastructure and mechanical properties during the retting step. *Carbohydr. Polym.* 48–56 (Under revi) 48–56. <https://doi.org/10.1016/j.carbpol.2018.10.065>.
- Bourmaud, A., Beaugrand, J., Shah, D.U., Placet, V., Baley, C., 2019. Towards the design of high-performance plant fibre composites. *Prog. Mater. Sci.* 97, 347–408. <https://doi.org/10.1016/j.pmatsci.2018.05.005>.
- Caliaro, M., Schmich, F., Speck, T., Speck, O., 2013. Effect of drought stress on bending stiffness in petioles of *Caladium bicolor* (Araceae). *Am. J. Bot.* 100, 2141–2148. <https://doi.org/10.3732/ajb.1300158>.
- Charlet, K., Béakou, A., 2011. Mechanical characterization and modeling of interfacial lamella within a flax bundle. *Procedia Eng* 10, 906–911. <https://doi.org/10.1016/j.proeng.2011.04.149>.
- Charlet, K., Baley, C., Morvan, C., Jernot, J.P.P., Gomina, M., Bréard, J., 2007. Characteristics of Hermès flax fibres as a function of their location in the stem and properties of the derived unidirectional composites. *Compos Part A Appl Sci Manuf* 38, 1912–1921. <https://doi.org/10.1016/j.compositesa.2007.03.006>.
- Charlet, K., Jernot, J.P., Gomina, M., Bréard, J., Morvan, C., Baley, C., 2009. Influence of an Agatha flax fibre location in a stem on its mechanical, chemical and morphological properties. *Compos. Sci. Technol.* 69, 1399–1403.
- Charlet, K., Jernot, J.P., Eve, S., Gomina, M., Bréard, J., 2010. Multi-scale morphological characterisation of flax: from the stem to the fibrils. *Carbohydr. Polym.* 82, 54–61.
- Clair, B., Arinero, R., Leveque, G., Ramonda, M., Thibaut, B., 2003. Imaging the mechanical properties of wood cell layers by atomic force modulation microscopy. *IAWA J.* 24, 223–230.
- Coroller, G., Lefevre, A., Le Duigou, A., Bourmaud, A., Ausias, G., Gaudry, T., et al., 2013. Effect of flax fibres individualisation on tensile failure of flax/epoxy unidirectional composite. *Compos Part A Appl Sci Manuf* 51, 62–70. <https://doi.org/10.1016/j.compositesa.2013.03.018>.
- Depuydt, D., Hendrickx, K., Biesmans, W., Ivens, J., Van Vuure, A.W., 2017. Digital image correlation as a strain measurement technique for fibre tensile tests. *Compos Part A Appl Sci Manuf* 99, 76–83. <https://doi.org/10.1016/j.compositesa.2017.03.035>.

- Doumbia, A.S.A.S., Castro, M., Jouannet, D., Kervoëlen, A., Falher, T., Cauret, L., et al., 2015. Flax/polypropylene composites for lightened structures: multiscale analysis of process and fibre parameters. *Mater. Des.* 87, 331–341. <https://doi.org/10.1016/j.matdes.2015.07.139>.
- Duval, A., Bourmaud, A., Augier, L., Baley, C., 2011. Influence of the sampling area of the stem on the mechanical properties of hemp fibers. *Mater. Lett.* 65, 797–800. <https://doi.org/10.1016/j.matlet.2010.11.053>.
- Esau, K., 1977. *Anatomy of Seed Plants*. Wiley, New York.
- Gindl, W., Schöberl, T., Schöberl, T., 2004. The significance of the elastic modulus of wood cell walls obtained from nanoindentation measurements. *Compos Part A Appl Sci Manuf* 35, 1345–1349.
- Goodman, A.M., Ennos, A.R., 1996. A comparative study of the response of the roots and shoots of sunflower and maize to mechanical stimulation. *J. Exp. Bot.* 47, 1499–1507. <https://doi.org/10.1093/jxb/47.10.1499>.
- Gorshkova, T.A., Chemikosova, S.B., Lozovaya, V.V., Carpita, N.C., 1997. Turnover of galactans and other cell wall polysaccharides during development of flax plants. *Plant Physiol.* 114, 723–729. <https://doi.org/10.1104/pp.114.2.723>.
- Gorshkova, T.A., Sal'nikov, V.V., Chemikosova, S.B., Ageeva, M.V., Pavlencheva, N.V., van Dam, J.E.G., et al., 2003. The snap point: a transition point in *Linum usitatissimum* bast fiber development. *Ind. Crops Prod.* 18, 213–221.
- Goudenhooff, C., Bourmaud, A., Baley, C., 2017. Varietal selection of flax over time: evolution of plant architecture related to influence on the mechanical properties of fibers. *Ind. Crops Prod.* 97, 56–64. <https://doi.org/10.1016/j.indcrop.2016.11.062>.
- Goudenhooff, C., Alméras, T., Bourmaud, A., Baley, C., 2019. The slenderness of flax plant and factors affecting its mechanical stability. *Biosyst. Eng.* 178, 1–8 (Under revi). <https://doi.org/10.1016/j.biosystemseng.2018.10.015>.
- Goudenhooff, C., Bourmaud, A., Baley, C., 2019. Conventional or greenhouse cultivation of flax: what influence on the number and quality of flax fibers? *Ind. Crops Prod.* 123, 111–117. <https://doi.org/10.1016/j.indcrop.2018.06.066>.
- Gourier, C., Bourmaud, A., Le Duigou, A., Baley, C., 2017. Influence of PA11 and PP thermoplastic polymers on recycling stability of unidirectional flax fibre reinforced bio-composites. *Polym. Degrad. Stab.* 136, 1–9. <https://doi.org/10.1016/j.polyimdegradstab.2016.12.003>.
- Griffith, A., 1921. The phenomena of rupture and flow in solids. *Philos Trans Roy Soc A* 21, 163–198.
- Grishanov, S.A., Harwood, R.J., Booth, I., 2006. A method of estimating the single flax fibre fineness using data from the LaserScan system. *Ind. Crops Prod.* 23, 273–287. <https://doi.org/10.1016/j.indcrop.2005.08.003>.
- Haag, K., 2016. Scatter in Tensile Properties of Flax Fibre Bundles : Influence of Determination and Calculation of the Cross- Sectional Area, pp. 7907–7917. <https://doi.org/10.1007/s10853-016-0052-z>.
- Haag, K., Müssig, J., 2016. Scatter in tensile properties of flax fibre bundles: influence of determination and calculation of the cross-sectional area. *J. Mater. Sci.* 51, 7907–7917. <https://doi.org/10.1007/s10853-016-0052-z>.
- Jäger, A., Hofstetter, K., Buksnowitz, C., Gindl-Altmatter, W., Konnerth, J., 2011. Identification of stiffness tensor components of wood cell walls by means of nanoindentation. *Compos Part A Appl Sci Manuf* 42, 2101–2109. <https://doi.org/10.1016/j.compositesa.2011.09.020>.

- Joffe, R., Andersons, J., Wallström, L., 2003. Strength and adhesion characteristics of elementary flax fibres with different surface treatments. *Compos Part A Appl Sci Manuf* 34, 603–612.
- Joffe, R., Andersons, J., Wallström, L., 2005. Interfacial shear strength of flax fiber/thermoset polymers estimated by fiber fragmentation tests. *J. Mater. Sci.* 40, 2721–2722.
- Keryvin, V., Lan, M., Bourmaud, A., Parenteau, T., Charleux, L., Baley, C., 2015. Analysis of flax fibres viscoelastic behaviour at micro and nano scales. *Compos Part A Appl Sci Manuf* 68. <https://doi.org/10.1016/j.compositesa.2014.10.006>.
- Konnerth, J., Gierlinger, N., Keckes, J., Gindl, W., 2009. Actual versus apparent within cell wall variability of nanoindentation results from wood cell walls related to cellulose microfibril angle. *J. Mater. Sci.* 44, 4399–4406.
- Kvavadze, E., Bar-Yosef, O., Belfer-Cohen, A., Boaretto, E., Jakeli, N., Matskevich, Z., et al., 2009. 30,000-Year-Old wild flax fibers. *Science* 325, 1359, 80-.
- Le, C.I.P.A.L.I.N., français, lin, 2017. leader sur tous les marchés. Plan Filière - Lin Fibre.
- Le Duigou, A., Bourmaud, A., Baley, C., 2015. In-situ evaluation of flax fibre degradation during water ageing. *Ind. Crops Prod.* 70 <https://doi.org/10.1016/j.indcrop.2015.03.049>.
- Leblicq, T., Vanmaercke, S., Ramon, H., Saeys, W., 2015. Mechanical analysis of the bending behaviour of plant stems. *Biosyst. Eng.* 129, 87–99. <https://doi.org/10.1016/j.biosystemseng.2014.09.016>.
- Lefevre, A., Bourmaud, A., Morvan, C., Baley, C., 2014. Elementary flax fibre tensile properties: correlation between stress-strain behaviour and fibre composition. *Ind. Crops Prod.* 52, 762–769. <https://doi.org/10.1016/j.indcrop.2013.11.043>.
- Lourd, J., 1964. le lin et l'industrie linière. Presses Universitaires de France, Paris.
- Marrot, L., Lefevre, A., Pontoire, B., Bourmaud, A., Baley, C., 2013. Analysis of the hemp fiber mechanical properties and their scattering (Fedora 17). *Ind. Crops Prod.* 51 <https://doi.org/10.1016/j.indcrop.2013.09.026>.
- Moothoo, J., 2014. Analyse de la faisabilité d' éco-conception de pièces composites à base de ressources renouvelables pour applications médicales To cite this version : HAL Id : tel-01064267 UNIVERSITÉ D' ORLÉANS Analyse de la faisabilité d' éco -conception de pièces co.
- Mosiniak, M., Prat, R., 2002. Les Textiles D'origine Végétale.
- Nair, S., Wang, S., Hurley, D., 2010. Nanoscale characterization of natural fibers and their composites using contact-resonance force microscopy. *Compos Part A Appl Acience Manuf* 41, 624–631.
- Niklas, K.J., 1995. Plant height and the properties of some herbaceous stems. *Ann. Bot.* 75, 133–142.
- Perremans, D., Hendrickx, K., Verpoest, I., Vuure, AW Van, 2018. Effect of chemical treatments on the mechanical properties of technical flax fibres with emphasis on stiffness improvement. *Compos. Sci. Technol.* 160, 216–223. <https://doi.org/10.1016/j.compscitech.2018.03.030>.
- Pickering, K.L., Aruan Efendy, M.G., Le, T.M., 2015. A review of recent developments in natural fibre composites and their mechanical performance. *Compos Part A Appl Sci Manuf* 83, 98–112. <https://doi.org/10.1016/j.compositesa.2015.08.038>.
- Rabe, U., Janser, K., Arnold, W., 1996. Vibration of free and surface coupled atomic force microscope: theory and experiments. *Rev. Sci. Instrum.* 67, 3281–3293.
- Réquilé, S., Goudenhoft, C., Bourmaud, A., Le Duigou, A., Baley, C., 2018. Exploring the link between flexural behaviour of hemp and flax stems and fibre stiffness. *Ind. Crops Prod.* 113, 179–186. <https://doi.org/10.1016/j.indcrop.2018.01.035>.

- Robertson, D.J., Smith, S.L., Cook, D.D., 2015. On measuring the bending strength of septate grass stems. *Am. J. Bot.* 102, 5–11. <https://doi.org/10.3732/ajb.1400183>.
- Robertson, D.J., Lee, S.Y., Julias, M., Cook, D.D., 2016. Maize stalk lodging: flexural stiffness predicts strength. *Crop Sci.* 56, 1711–1718. <https://doi.org/10.2135/cropsci2015.11.0665>.
- Romhány, G., Karger-Kocsis, J., Czigány, T., 2003. Tensile fracture and failure behavior of technical flax fibers. *J. Appl. Polym. Sci.* 90, 3638–3645.
- Schulgasser, K., Witztum, A., 1992. On the strength, stiffness and stability of tubular plant stems and leaves. *J. Theor. Biol.* 497–515.
- Shah, D.U., Reynolds, T.P., Ramage, M.H., 2017. The strength of plants: theory and experimental methods to measure the mechanical properties of stems. *J. Exp. Bot.* (in press) <https://doi.org/10.1093/jxb/erx245>.
- Siniscalco, D., Arnould, O., Bourmaud, A., Le Duigou, A., Baley, C., 2018. Monitoring temperature effects on flax cell-wall mechanical properties within a composite material using AFM. *Polym. Test.* 69 <https://doi.org/10.1016/j.polymertesting.2018.05.009>.
- Snegireva, A.V., Ageeva, M.V., Vorob'ev, V.N., Anisimov, A.V., Gorshkova, T.A., 2006. Plant fiber intrusive growth characterized by NMR method. *Russ. J. Plant Physiol.* 53, 163–168. <https://doi.org/10.1134/s1021443706020038>.
- Snegireva, A.V., Ageeva, M.V., Amenitskii, S.I., Chernova, T.E., Ebskamp, M., Gorshkova, T.A., 2010. Intrusive growth of sclerenchyma fibers. *Russ. J. Plant Physiol.* 57, 342–355. <https://doi.org/10.1134/s1021443710030052>.
- Spatz, H.-C., Speck, T., Vogellehner, D., 1990. Contributions to the biomechanics of plants. II. Stability against local buckling in hollow plant stems. *Bot. Acta* 103, 123–130.
- Stamboulis, A., Baillie, C.A., Garkhail, S.K., van Melick, H.G.H., Peijs, T., 2000. Environmental durability of flax fibres and their composites based on polypropylene matrix. *Appl. Compos. Mater.* 7, 273–294.
- Tanguy, M., Bourmaud, A., Baley, C., 2016. Plant cell walls to reinforce composite materials: relationship between nanoindentation and tensile modulus. *Mater. Lett.* 167, 161–164. <https://doi.org/10.1016/j.matlet.2015.12.167>.
- Thomason, J.L., Carruthers, J., Kelly, J., Johnson, G., 2011. Fibre cross-section determination and variability in sisal and flax and its effects on fibre performance characterisation. *Compos. Sci. Technol.* 71, 1008–1015. <https://doi.org/10.1016/j.compscitech.2011.03.007>.
- Thygesen, A., Madsen, B., Bjerre, A.B.A.B., Lilholt, H., 2011. Cellulosic fibers: effect of processing on fiber bundle strength. *J. Nat. Fibers* 8, 161–175. <https://doi.org/10.1080/15440478.2011.602236>.
- Timoshenko, S.P., 1947. *Strength of Materials - Part 2 - Advanced Theory and Problems*. 9th printing. van, Nostrand.
- Velde, K Van de, Baetens, E., 2001. Thermal and mechanical properties of flax fibres as potential composite reinforcement. *Macromol. Mater. Eng.* 286, 342–349.
- Yamanaka, K., Nakano, S., 1996. Ultrasonic atomic force microscopy with overtone excitation of cantilever. *Jpn. J. Appl. Phys.* 35, 3787–3792.

Enzymatic treatment of natural fibres

7

Ryszard M. Kozłowski¹, Wanda Różańska²

¹Journal of Natural Fibres Editor-in-chief, coordinator of FAO/SCORENA European Cooperative Research Network on Flax and other Bast Plants, former director of the Institute of Natural Fibres, Poznan, Poland; ²Institute of Natural Fibres and Medicinal Plants, Poznań, Poland

7.1 Introduction

Enzymes catalyze multiple reactions from a reactant to a product, often evolve a way to get intermediates from one active site to another (Arnaud, 2018). Amylases, cellulases, chitanases, lysozymes and xylanases are all insoluble polysaccharide hydrolases (Saddler and Penner, 1996).

Enzyme application, once confined to the food and paper industries, is becoming an increasingly important technology in the textile industry. In the area of natural fibres such as bast fibrous plants, enzymes play the main role in degumming the plants as well as improving the cleanliness, homogeneity, fineness and softness of the natural fibres. This has a fundamental impact on the competitiveness of the fibres, allowing, for example, bast fibres to be blended with other natural or synthetic fibres. Enzymes are also used for retting of bast fibrous plants, degumming decorticated green fibres and in finishing of textile products.

Selection and application of the appropriate enzyme is the main problem faced by textile manufacturers when using enzymes.

Enzymes are used in lignocellulosic fibres such as: seeds (cotton), bast (flax, hemp, kenaf, jute, ramie), leaves (e.g., curaua, pineapple, abaca) and protein (wool, silk).

7.2 Key principles of enzyme treatment of natural fibres

Enzymes are produced by living organisms and play a role as biocatalysts in biochemical processes. They are protein substances consisting of two parts: the ‘carrier’ (protein) and the active part of the enzyme. They are biodegradable in effluents, which contributes to environmental protection and fulfils the demands of ‘green chemistry’.

The most significant property of enzymes is their catalytic power and scope for specificity when used for catalyzing chemical reactions, as well as the choice of substrates.

Enzymatic catalysis accelerates the change of substrate into product, while maintaining balance within the overall process. A single enzyme particle interacts with thousands of particles in the substrate and the character of changes depends on the

process conditions. The velocity of enzymatic reactions is called the ‘activity’ of the enzyme. Enzymatic catalysis differs from chemical catalysis due to: (a) the higher velocity of the reaction; (b) the more delicate conditions of action; and (c) the higher specificity of the reaction.

- Enzymes accelerate but do not affect the balance of a reaction.
- The majority of enzymatic catalysis takes place in milder conditions than chemical catalysis: at temperatures below 100°C, at atmospheric pressure and with a pH of four to eight, without the necessity of applying aggressive chemicals or solutions.
- Chemical catalysis is mostly applied only to one or several strictly related chemical reactions. Enzymes could be widely applied as catalysts in the textile industry due to the above mentioned features.

Enzymes can be sourced from many different microorganisms, for example: mildews such as *Aspergillus oryzae*, *Aspergillus niger*, *Aspergillus aureus*, *Aspergillus wentii*, *Aspergillus flavus*, *Mucor hiemalis*, *Mucor stolonifer*, *Rhizopus nigricans*, *Rhizopus tricii*, *Rhizopus chinensis*, *Rhizopus artocarp*, *Sclerotinia cinerea*, *Pythium debaryanum*, *Botrytis cinerea*, *Cladosporium herbarum* Line, *Erwinia carotovora*, *Trichoderma reesei*, *Trichoderma viride*; bacteria such as *Clostridium felsineum*, *Bacterium amylobacter*, *Escherichia coli*, β -galactosidase and so on. The most active complexes of enzymes are derived from the mildew *A. niger* and from the bacteria *C. felsineum*.

Enzymes can be applied in the degumming of bast fibrous plants and of green decorticated bast fibres, as well as in the finishing of textile products.

7.2.1 Degumming of bast fibrous plants

In the conventional cold and retting methods, bacteria such as *Bacillus amylobacter*, *Bacillus felsineus*, *Granulobacter pectinovorum*, *C. felsineum* and *Bacillus comesii rossi* cause the fermentation of pectin and degumming of fibre. In the cases of flax and hemp, retting without an enzyme catalyst takes c.70–100 h. Sometimes nutrient-rich substances such as urea can be used to accelerate the process to last c.40–50 h (Kozłowski, 1970).

During dew-retting, the stems of the flax are kept damp by rain and dew and various fungi, such as *C. herbarum*, *Mucor* sp., *Rhizopus* sp. and *Epicoccum nigrum*, *Trichoderma reesei*, *Trichoderma viride* colonize the stems (Sharma, 1988). Dew-retting is still used on an industrial scale by flax producers.

During retting of bast fibrous plants, the application of the enzymatic mixture is quicker. Applying enzymes at the same time as degumming of the fibre from the woody core means that the pectin disperses between the bundles of fibre. This process shortens the degumming process and enhances the quality of the fibres, mainly due to increased ease of divisibility and finer fibre ribbons (Batog et al., 2006, Kozłowski et al., 2006).

The main focus area of our investigation was the enzymatic retting of flax (*Linum usitatissimum* L.) and degumming of ramie (*Boehmeria nivea*) and sunn hemp (*Crotalaria juncea*). In the case of flax retting, the effect of pectinolytic and cellulolytic enzymes was investigated.

Chelators added to enzyme mixtures increase the efficiency of enzyme retting of flax. The application of chelators such as ethylenediaminetetraacetic acid (EDTA) or Mayoquestn, a commercial chelator containing 38% EDTA, causes the removal of Ca^{2+} from pectin bridges and destabilizes cell wall structure (Adamsen et al., 2002; Akin et al., 2002a).

To decrease the amount of enzyme used in retting, a new method, spray enzyme retting (SER), was tested (Akin et al., 2000). The method was as follows. The stems were crimped to enhance penetration of the enzyme (Flaxzyme) formulation into the stem tissues; then chelators were added to the enzyme formulation in water at pH 5, to improve enzyme effectiveness. The formulation was sprayed onto the crimped stems to soak in and the stems were incubated at high humidity for several hours (Akin et al., 2000, 2002a,b).

Epps et al. (2001) described the colour of enzyme-retted flax fibres affected by processing, cleaning and 'cottonizing'. Fibre lightness significantly increased with additional cleaning steps. The results indicate that objective colour measurements and colour standards can define important fibre properties, which can then be used to tailor raw materials for specific industrial applications.

Tests were then undertaken to determine the influence of a water pre-soak on enzyme retting of flax. It was shown that pre-soaking increased fine fibre yield in some cases, but also reduced the fibre strength (Akin et al., 2003).

Bast fibrous plant retting processes and ways of upgrading them, particularly when concerned with the use of enzymatic preparations, were reviewed by Kozłowski et al. (2001a,b, 2005).

The research revealed that the application of this enzyme results in shortening of the process time by 33% as compared to water retting. Additionally, the enzyme can be used for modification of flax and hemp hackling noils. The fibre was characterized by excellent separation into smaller bundles and elementary fibres in the mechanical processing operations, which made it capable of being processed in blend with cotton, wool or man-made fibres using techniques specific to each of these raw materials.

Evans et al. (2002) conducted research into the modification of dew-retted flax fibre. The use of atomization or aerosol formation was investigated for enzyme treatment of dew-retted flax fibres. Evans et al. applied the cellulase/endoglucanase in atomization for modifying fibre properties.

Himmelsbach et al. (2002) used Fourier transform infrared (FTIR) microspectroscopic mapping to study the effects of enzymatic retting of flax stems. They found this analytical tool a promising technique for studying the effects of enzymatic treatment of natural fibre materials.

J. Jayapriya and C. Vigneswaran studied the optimization process of biosoftening of lignocellulosic fibre – jute with white rot fungi and specific enzymatic system (Jayapriya and Vigneswaran, 2010).

Jute is a strong, stiff natural fibre, aggregates single cells mainly consist of α -cellulose, glued by lignin and hemicellulose. The research investigated the effect of using white rot fungi (namely, *Phanerochaete chrysosporium* and *Ceriporiopsis subvermispora*) – cellulase enzymes and a mixture of enzymes: pectinase, cellulase, xylanase under specific treatment conditions. The results show, that used fungi and enzymes

degraded effectively lignin and reduced flexural rigidity, tenacity, and improved elongation of the fibre. Scanning electron microscopy (SEM) reveals the degradation of the jute fibre on the surface and removal of the gummy substances present on the surface.

Zheng Laijiu, Du Bing, and Huang Xiubao studied the kenaf fibre enzymatic degumming by *Aspergillus niger* (AS3.350) and pectinase. They optimized the degumming parameters as follow: temperature 34–36°C, time 48–50 h, pH 6.5–7.5. After this process fibre gained a smoother surface, better separation availability, less impairment, higher strength and contamination to the environment was little only (Zheng et al., 2007).

Danny E. Akin, Gunnar Henriksson, Jeff D. Evans, Anders Peter S. Adamsen, John A. Foulk, and Roy B. have developed a new method of flax retting, using rich enzyme mixture with pectinase and chelator, based on lower cost of retting and higher fibre yield. Enzyme was sprayed on stems of flax and crimped to physically disrupt plants protective barrier and then sprayed until soaked with or briefly immersed in enzyme/chelator formation. This method contributes to effective retting of flax, with low ratio of liquid to fibre. The method with enzyme/chelator system allows the decreasing the amount of applied enzymes.

Sudripta Das, Indhumthi, V. Indupriya, M. and Rajeev, K. studied enzymatic treatment of cotton/bamboo knitted fabric. Sample treated by cellulase were evaluated for weight loss, pilling resistance, abrasion resistance, and relative colour strength values. They observed that temperature affects the performance of cellulose on cotton/bamboo knitted fabric. Optimum tested enzyme's activity was achieved in temperatures between 40 and 50°C, but at 70°C enzyme action came to zero and enzymes were deactivated at temperatures higher than 70°C (Das et al., 2018).

Ruo-Yao Ding, Xing-Qun Zhang, and Chong Wen Yu explored optimization of enzymatic degumming of ramie fibre. Production of enzyme mixture was conducted by cultivating *B. subtilis*. Pectinase and xylanase activities were measured by DNSA method. Optimum parameters of enzyme production were: pH 8.45, temperature 40°C, inoculum size 5%, shaking speed 205 rpm and degumming time 24h. By using obtained enzyme mixture under the optimal condition, the removal of residual gum was successfully achieved and resultant ramie fibre had only 10.94% of the origin gum. Ramie fibres retain enough tenacity to meet all textile requirements (Ding et al., 2014).

John A. Foulk, Danny E. Akin, Roy B. Dodd published in BioResources the research on the influence of pectinolytic enzymes on retting effectiveness of bast fibrous plants and fibre properties. New commercial pectinase products were evaluated with and without EDTA for retting efficiency. The Fried Test identified the most efficient enzymes and best retting conditions. All tested enzymes performed retting of flax straw more efficiently in presence of EDTA. Viscozyme, which has been used extensively in the enzyme-retting research, and several pectinolytic enzymes were compared in pilot plant scale tests. Texam BFE and Bioprep 3000 L, as well as viscozyme performed retting of flax in this system; obtained fibre had higher tenacity (Foulk et al., 2007).

The most important problem with enzymatic retting, and the probable reason for its limited use, is the cost of using enzymes to ret bast straw. The degumming of green decorticated fibres is another problem connected with enzymatic retting, which has not yet been solved. Other issues include the changes in the odour of the liquor that occur after five cycles of recycling the enzyme formulation.

7.2.2 Finishing in textile industry

Using enzymatic agents in finishing processes in the textile industry can render the processes less hazardous to the environment, as well as producing textile goods with qualities such as improved comfort (a soft handle or feel, decreased fabric weight, reduced tendency to pilling) and increased lustre. The major problem when using enzymatic agents is the selection of the proper enzymes and process conditions, as well as the costs of application.

Generally, enzymes are used in the following textile process (Guebitz et al., 2006; Mahapatra, 2007; Manickam and Prasad, 2005; Murth, 2004):

- biopolishing,
- desizing,
- scouring,
- bleach clean up,
- modification of wool fibre,
- silk degumming.

7.2.2.1 Biopolishing

Tabatabaie, G.R.S.M., Haghghat Kish, M., Salahshour Kordestani, S. have studied the enzyme biopolishing on cotton fabric and effects of *Neurospora crassa* on cotton fabric properties (Tabatabaie et al., 1996).

Biopolishing/biofinishing (Schindler and Hauser, 2005; Sójka-Ledakowicz et al., 2000; Vishnu Vardhini and Selvakumar, 2006) allows for:

- attractive appearance of fabrics and nonwoven surfaces
- decreased tendency to pilling
- soft touch (including the peach-skin effect)
- unique softness and smoothness of the product.

The aim of biopolishing is removal of short fibres that stick out from the yarn. For successful biopolishing, it is necessary to utilize mechanical as well as biochemical treatments.

The most common biopolishing process is denim processing. Denim is a rugged cotton twill textile, in which the weft passes under two (*twi*- 'double') or more warp threads. This produces the familiar diagonal ribbing identifiable on the reverse of the fabric, which distinguishes denim from cotton duck. Biofinishing can also be used for regenerated cellulose fabrics, especially for articles made of lyocell and microfibre (Hohberg and Thumm, 1999).

7.2.2.2 Desizing

This is the process of removing sizing components from fabrics, garments and other articles made of natural fibre (Mahapatra, 2007). The sizing material is applied to the yarn during weaving to strengthen it and reduce the wear and tear. Improper size removal results in an uneven and inconsistent finish. Amylase is the main type of enzyme used in desizing, as it decomposes starch to water soluble compounds

(dextrin and sugar) in the sizing preparations. Depending on the temperature applied during the process, three types of enzymes can be distinguished:

- conventional: 60–70°C,
- heat stable: 80–100°C,
- active at room temperature.

The enzymatic degumming process is used in the pad-steam method, in the periodic method (e.g., in valve dyeing machines) and in the pad-batch method of degumming (Mikulka, 2003). The pad-steam method, which requires the application of new generation amylases characterized by a high efficiency of starch degradation at high temperatures, allows for significant reduction of the degumming time.

7.2.2.3 Scouring

Scouring is the removal of non-cellulosic substances (in cotton: waxes, pectins, proteins; in bast fibres: waxes and fats, pectin and partially lignin, hemicelluloses) from cotton or bast fibre fabrics. Bioscouring gives better wetting and penetration properties, making the subsequent bleaching process easy and resulting in much better dye uptake (Moghe and Nabar, 2006).

Scouring of flax roving with the aid of enzymes was tested by Ossola and Galante (2004). These authors demonstrated the advantages of scouring with the enzymes tested, under mild reaction conditions, in comparison with traditional chemical scouring. On a laboratory scale a decreasing order of effectiveness was observed, as follows: pectinase > xylanase = galactomannanase = protease > lipase > or = laccase. Next, the pectinase was applied on a pilot scale. Enzyme preparation of rove yielded better results than traditional chemical scouring, including higher yarn count, increased strength and decreased number of imperfections of the yarn after spinning. The enzyme-treated material was also considered excellent by expert eye examination in terms of degree of whiteness.

7.2.2.4 Bleach clean up

Sodium hypochlorite, sodium chlorite and hydrogen peroxide are traditionally used for bleaching cotton and linen products (Sójka-Ledakowicz et al., 2000). The peroxide method of bleaching does not allow the formation of organic chlorine compounds (AOX), but it does risk damaging the cellulose fibres as a result of uncontrolled (too intensive) degradation of H₂O₂. In order to reduce the concentration of hydrogen peroxide and eliminate alkali and stabilizers from the bleaching baths, enzymes from the oxidoreductase group have been introduced as biocatalysts for oxygenation reactions of coloured impurities of cotton fibres. These enzymes are used in the finishing process for jeans fabrics, in order to create a 'stone-washed' effect, caused by topical removal of the indigo dye. In this process, no damage of the fibre occurs, thus the products do not lose their mechanical parameters. Moreover, adding peroxidase (a type of oxidoreductase) to the bleaching bath after the process enables decomposition of the remains of the H₂O₂ without the necessity for repeated rinsing of the bleached product. In such cases, it is possible to apply the dyestuff and carry out the dyeing process in a single bath, which reduces the consumption of water, time and energy.

7.2.2.5 Silk degumming

Enzymes are used in the pretreatment stage as agents for the removal of gum sericin and accompanying impurities such as fats, waxes, natural pigments and mineral components.

The enzymes react with specific sites of the sericin. Enzyme degumming involves the proteolytic degradation of sericin, using specific proteins with minimum effect on fibroin (Ibrahim et al., 2007). Additionally, the application of enzymes excludes the use of soap, which significantly improves the dyeing process, especially in the case of reactive dyes. The pretreatment of silk therefore consists of two stages depending on the quality requirements (Iyer, 2004):

1. degumming/desizing,
2. bleaching.

Mahmoodi et al. (2010) studied degumming with ultrasonic, ultrasonic-soap, and ultrasonic-enzyme (Alcalase, Savinase and mixtures of these enzymes) processes. These are cleaner and more environmentally friendly techniques for the surface modification of Persian silk. The results of this research support the potential production of new environmentally friendly textile fibres.

Degumming of silk fibres was studied by Juhea Kim, MiYeon Kwon, and Suyeon Kim.

The research applied alkaline protease, like Savinase and Alcalase in comparison with conventional alkaline treatment. Efficiency of degumming was evaluated by estimation of residual silk sericin in terms of weight loss and surface staining with reactive dye. The morphology of silk fibres was estimated by SEM, and the regular removal of sericin and less damage to fibroin detected in enzymatically treated silk. Lustre and strength of silk was retained after degumming in order to obtain high quality fabrics. Savinase in comparison with Alcalase occurred to be a better degumming agent, showing higher weight loss, water absorbency and dye staining (Kim et al., 2016).

7.2.2.6 Modification of wool fibre

The application of enzymes could be used to replace the traditional process of washing greasy wool in chemicals with a more delicate process. This would also improve the surface parameters of wool fibres and fabrics, for example, coarseness, shrinkage and improvement of the softness. Enzymatic treatment also reduces pilling and felting of wool products (Breier, 2000).

In the late 1990s, significant progress was made in research on the effect of proteolytic enzymatic preparations on the structure and parameters of wool fibres (Bishop et al., 1998; Hollfeder et al., 2000; Schumacher et al., 2000; Shen et al., 1999). A method for removing plant impurities from fabrics was also patented in this decade (Sedelnik et al., 1986), as well as the Biocarbo technology (Sedelnik, 1993). The Biocarbo technique uses enzymes that influence the pectin—cellulosic compounds, that is, plant impurities, but which are neutral towards protein compounds (wool fibres).

There are also several reports on successful tests using some enzyme groups for reducing wool shrinkage (Heine et al., 1995; Riva et al., 1993).

The use of protease enzymes to achieve wool shrinkage, better whiteness and improved handling and dyeing is of considerable interest to researchers. Partial non-shrink action has been observed on wool when treated with streptomyces protease. This means that the protease enzymes did not have any effect on the wool surface but did enhance the action of a chemical treatment and a lipoprotein (lipase), as well as reducing the shrinking tendency of wool (Muthu Manickam and Prasad, 2005).

El-Gabry L., El-Nouby G., Allam O.G., and El-Sayed H. Developed a new mechanical and enzymatic treatments of wool fibres. Subsequent treatment of wool with sodium sulfite and proteolytic enzyme – savinase 16L, Type EX has been conducted. Treated coarse wool fibres got better dyeability with acid, reactive and basic dyes than untreated ones. Also felting resistance of wool has been improved to an acceptable degree. SEM showed changes in the morphological structure of the wool fibres and the improved performance of coarse wool (El-Gabry et al., 2008).

The book *Biotechnology in Textile Processing*, edited by R.M. Kozłowski, and guest editors G. M. Guebitz and A. Cavaco-Paulo, A. in 2006 contains the following chapters written by international team of authors: Antagonism of *Trichoderma* or *Gliocladium* species on two phytopathogenic species of *Fusarium*; Production of cellulase-free polygalacturonase preparation by *Sclerotium rolfsii* for bioscouring of cotton; Enzymatic modification of hemp fibres for sustainable production of high quality materials: influence of processing parameters; Enzyme-retted flax using different formulations and processed through the USDA flax fibre pilot plant; Influence of enzymatic pretreatment on the colours of bleached and dyed flax fibres; Combined bioscouring and bleaching of cotton fibres; The effects of ultrasound on the performance of industrial enzymes used in cotton bio-preparation/bio-finishing applications; Survey and recent report on enzymatic processing of bast fibres; Laccase catalyzed indigo carmine transformation; Optimization of enzymatic scouring; Designing wood fibre morphology and mechanical properties of fibreboards; Enzymatic scouring for better textile properties of knitted cotton fabrics; Integrated enzymatic pre-treatment of cotton fabrics; Enzymatic finishing of wool fabrics; effects of different treatments with a protease on physical and chemical parameters of the fabric; Analytical methods for chitosan (Guebitz et al., 2006).

7.3 Main types of enzyme treatments for natural fibres

Recently the following groups of enzymes have been applied in textile processing (Inderpal, 2004; Manickam and Prasad, 2005):

- α -amylase,
- cellulases,
- catalases,
- pectinase,
- proteases,
- laccase.

7.3.1 Amylase

Amylase is a hydrolytic enzyme from the hydrolases group. The official name of α -amylase is 1,4- α -D-Glucan glucanohydrolase; EC 3.2.1.1. α -amylase hydrolyzes α -(1-4) glycoside bonding of amylose, which results in the formation of maltose (α -glucose disaccharides).

In commercial applications, a thermo-labile α -amylase produced from *Bacillus licheniformis* is used. Unlike the thermo-stable α -amylase, it is active and stable at temperatures above 90°C. In addition, the reactivity of thermo-labile α -amylase is much less dependent on the presence of Ca^{2+} ions and on the pH applied than its thermo-stable counterpart.

In the textile industry, substances containing starch or its hydrolyzates are used to glue the warp. The degumming process is essential to remove the gum that hinders the subsequent technological processes (bleaching, dyeing and printing). α -amylase is used for that purpose (Sójka-Ledakowicz et al., 2000).

7.3.2 Cellulases

Cellulases are a group of enzymes that cause decomposition of cellulose. They belong to the third class of enzymes: hydrolases. Cellulases can catalyze the hydrolysis reactions of β -1,4-glycoside bonds that occur between glucose molecules within cellulose. The initial result of this reaction is cellobiose (double sugar unit) and later glucose.

Cellulases are widely used in the textile industry for modification of the surface and properties of cellulosic fibers and fabrics. These enzymes are tools for improving the basic processing steps in textile manufacture and for creating new types of fabric (Miettinen-Oinonen, 2007). The applications of cellulases in textile processing are classified into two areas as follows: biopolishing and biostone washing. The main objective of these processes is to remove the fuzz and cotton pill balls from fabrics as a result of long wet processing or garment dyeing cycles (Cavaco-Paulo and Almeida, 1994; Kochavi et al., 1990; Tyndall, 1992).

Increased use is also being made of cellulases in domestic fabric washing products, where they are claimed to improve appearance and colour brightness by cleaning fibre surface (Cavaco-Paulo et al., 1997). Nowadays, these finishing and washing effects represent the largest market for cellulase enzymes worldwide.

7.3.3 Catalases

Catalase (EC 1.11.1.6) is an enzyme from the oxidoreductase group that catalyzes the decomposition of hydrogen peroxide to water and oxygen.

Catalase is used in the textile industry in the bleach clean up process, removing hydrogen peroxide from fabrics to make sure the material is peroxide-free. Bleach clean up is a term chosen by Novo Nordisk to describe this process of removing residual hydrogen peroxide after bleaching and prior to dyeing (Pedersen, 1994). The enzyme can be applied directly after the bleaching stage. The rinsing step is not required when using the enzyme because the bleaching agent is decomposed and the residues of the enzyme have no effect on textile fibres or dyestuffs (Jensen, 2000).

7.3.4 Pectinases

Pectinases are a group of enzymes that contribute to the breakdown of pectic materials. Pectinolytic enzymes are involved in the retting and degumming of bast fibrous plants, such as flax, hemp, ramie, kenaf (*Hibiscus sativa*), jute and coir from coconut husks (Bruhlmann et al., 1994; Chesson, 1980).

Proper removal of the substances that stick the bunches of elementary fibres together ensures fibre divisibility and fineness, making the fibres easier to spin (Ivanov et al., 1984; Kasprzak et al., 1983).

The results published by Ehrlich and Schubert (1926), who were the first to present the concept of the chemical structure of flax pectin, have shed light on the type and quantitative composition of the structural substances of pectins. In Fig. 7.1 the decomposition of flax pectin to different products is shown.

The pectin is decomposed into its structural substances during dew-retting (predominantly by fungal action) and during water retting (predominantly by bacterial action) caused by enzymes (Behrens, 1904–06). Davidson and Willaman (Schilling and Muller, 1951) have found three enzymes capable of decomposing pectin, namely protopectinase (inactive at 48°C), pectinase (at 60°C) and pectase (at 68–70°C). The probable mechanism of enzymatic action is presented in Fig. 7.2.

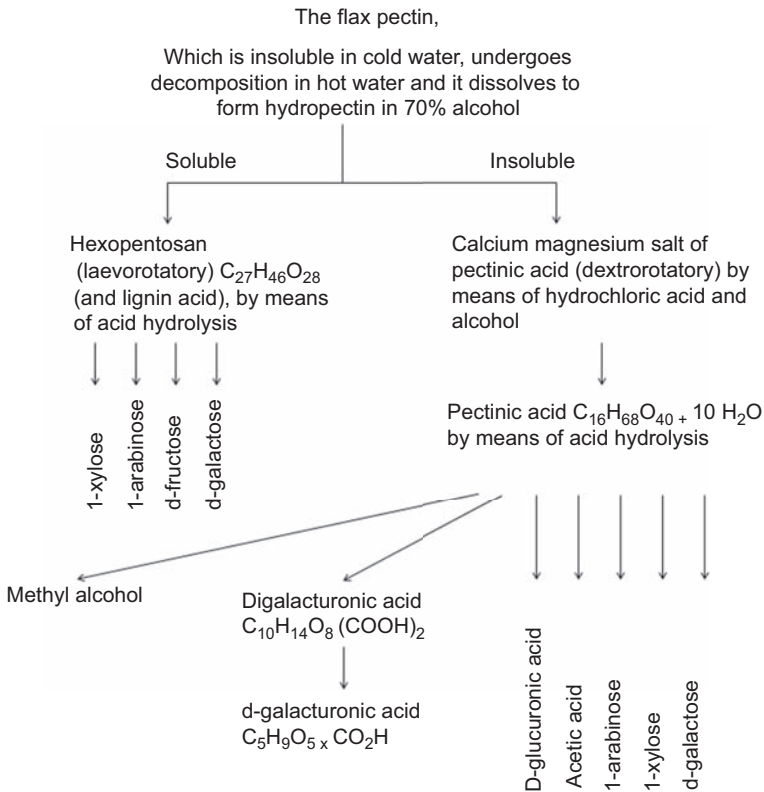

Figure 7.1 Flax pectin decomposition and its products.

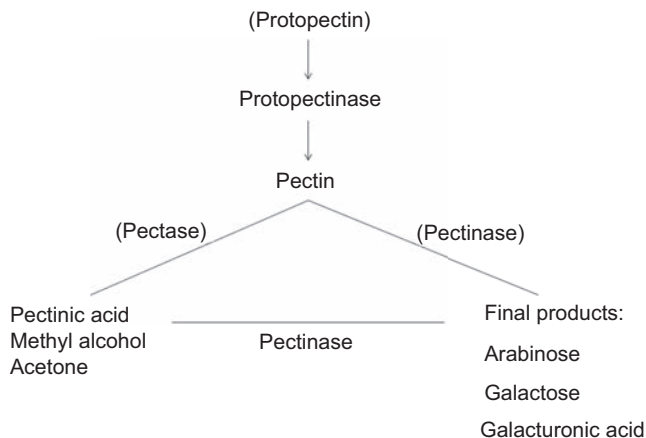

Figure 7.2 Predictable mechanism of enzymatic action.

The natural retting of flax is an uncontrolled process catalyzed by enzymes produced by fungi and bacteria.

To provide optimum conditions for the ‘retting’ microorganisms capable of accelerating the pectolytic process to develop, retting stimulants in the form of a nutrient or fermentation medium were used. This makes it easier to separate the fibre bundles from the woody parts of the stem. It also results in pectin decomposition in the fibre bundles, so that the bundles can be divided more easily and the fibre becomes finer.

7.3.5 Proteases

Proteases are enzymes from the hydrolase group labelled as EC 3.4 code. Proteases hydrolyze peptide bonds.

In the textile industry, proteases may also be used to remove the stiff and dull gum layer of sericin from raw silk fibre to achieve improved lustre and softness. Protease treatments can also modify the surface of wool and silk fibres to provide new and unique finishes, and have been used in the hide-dehairing process, where dehairing is carried out at pH values between 8 and 10 (Breier, 2000; Najafi et al., 2005; Stohr, 1995).

7.3.6 Laccase

Laccase (EC 1.10.3.2) belongs to the blue copper proteins, where copper performs various biological functions, including carrying electrons, accumulating copper and numerous oxidizing processes. Laccase is one of the common groups of oxidoreductases, which are present in most fungi and in some bacteria (Polak and Jarosz-Wilkolazka, 2007). These enzymes catalyze the oxidation of a wide range of organic and inorganic compounds in which molecular oxygen is reduced to water.

These functions depend on the four copper ions that are present in laccase, where one copper ion of type I, one copper ion of type II, and two copper ions of type III, are

conjugated to have antiferromagnetic properties. All four copper ions take part in the enzymatic catalysis.

During the catalysis, substrate is oxidized and oxygen is simultaneously reduced to water. A typical reaction for all blue oxidoreductases can be presented in a single-electron process:



where D is the electron donor.

This type of reaction depends on the oxidation metabolism, which cannot occur in a non-enzymatic process. Two-sided transformation of two water molecules and two oxygen molecules linked to the charge of four electrons can be shown as:



The general scheme of the reaction is as follows:

Laccase				$2\text{e}^- (+4\text{H}^+)$
	Copper	Type I	Cu^{1+}	
	Copper	Type III	Cu^{2+}	
	Copper	Type III	Cu^{2+}	
	Copper	Type II	Cu^{1+}	2e^- (from substrate)

Laccase is used in the decomposition of waste dyeing substances from the textile, pulp and paper industries (Polak and Jarosz-Wilkolazka, 2007).

Laccases such as those produced by the fungus *Pleurotus ostreatus*, play a role in the degradation of lignin and can therefore be included in the broader category of *ligninases*.

The most important enzymes that cause lignin degradation are lignin peroxidases (LiP), manganese peroxidases (MnP), laccases and other enzymes such as cellulases, quinine oxidoreductases (CBQ), celobiotic dehydrogenases (CDH), ethanediol oxidases (GLOx), glucose oxidases and a number of esterases that can also play some role in the complex process of natural degradation of wood (Ander, 1994; Ander et al., 1990; Daniel et al., 1994; Marzullo et al., 1995; Puls et al., 1991).

Moreover, this enzyme can be used for bonding lignocellulosic fibres by pretreatment with laccase (Batog et al., 2008). The first to try bonding wood fibres with middle lamella catalyzed by laccase was Körner (1990). This process was described in the patent application by Kharazipour et al. (1993).

The effect of enzymes on lignocellulosic raw materials, including wood, involves an activation that is similar to the action of oxidizing compounds but is of a much more

delicate character and less harmful to the environment (Batog et al., 2008). The concept of enzymatically catalyzed bonding of lignocellulosic materials is based on the reactivity of functional groups of aromatic compounds, especially lignin, which are generated by oxidoreductases such as peroxidase and laccase (Eriksson, 1990; Jin et al., 1991; Kharazipour, 1991; Yaropolov et al., 1994) according to the equations below:

Peroxidase

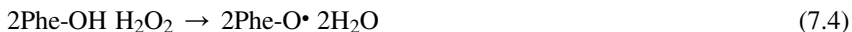

Laccase



During the enzyme-initiated steaming process of radicals, lignin monomers undergo polymerization to three-dimensional conjugated aromatic polymer. To date, several detailed models of lignin structure have been put forward, for example by Freudenberg (1964) and Glasser and Glasser (1981), but its specific structure remains unknown.

7.4 Future trends

The role and area of enzyme application is growing. In the textile industry, especially in the area of natural fibres (lignocellulosic and protein) where the main problem is lack of homogeneity and appropriate quality, enzymatic treatment plays a more and more important role.

The main limitation to the wide application of enzymes is their cost. Recently, however, it has been observed that global producers of enzymes introduce their products to the market at lower prices, which allows for wider application of enzymes in textile production. The main use of enzymes is in the degumming and finishing of raw textile materials and products. This makes the use of enzymes more reasonable from an economic viewpoint. Growing awareness about water pollution in the textile industry is another important factor, which forces producers to take into consideration the application of more enzymes to replace polluting chemicals.

7.5 Sources of further information and advice

Companies producing enzymes include:

- BASF, Germany
- Biocon Pvt Ltd, India
- C. H. Boehringer Sohn, Germany
- Ciba-Geigy, A.G., Switzerland
- Grinsteelvaeket, Denmark
- INOTEX, Czech Republic
- Kikkoman Shoyu Co., Japan

- Novo Nordisk A/S, Denmark
- Novozymes, Denmark
- ZPOW Pektowin S.A., Poland — belonging to NATUREX Company
- Rohm, GmbH, Germany
- Schweizerische Ferment, A.G., Switzerland
- Société Rapidase, S.A., France
- Wallerstein, Co., USA.

References

- Adamsen, A.P.S., Akin, D.E., Rigsby, L.L., 2002. Chelating agents and enzyme retting of flax. *Text. Res. J.* 72 (4), 296–302.
- Akin, D.E., Dodd, R.B., Perkins, W., Henriksson, G., Eriksson, K., 2000. Spray enzymatic retting: a new method for processing flax fibres. *Text. Res. J.* 70 (6), 486–494.
- Akin, D.E., Foulk, J.A., Dodd, R.B., 2002a. Influence on flax fibres of components in enzyme retting formulations. *Text. Res. J.* 72 (6), 510–514.
- Akin, D.E., Słomczyński, D., Rigsby, L.L., Eriksson, K., 2002b. Retting flax with endopolygalacturonase from *Rhizopus oryzae*. *Text. Res. J.* 72 (1), 27–34.
- Akin, D.E., Morrison III, W.H., Rigsby, L.L., Evans, J.D., Foulk, J.A., 2003. Influence of water presoak on enzyme-retting of flax. *Ind. Crops Prod.* 17 (3), 149–159.
- Ander, P., 1994. The cellobiose-oxidizing enzymes CBQ and CbO as related to lignin and cellulose degradation — a review. *FEMS Microbiol. Rev.* 13, 297–311.
- Ander, P., Mishra, C., Farrell, R.L., Eriksson, K.E., 1990. Redox reactions in lignin degradation: interactions between laccase, different peroxidases and cellobiose: quinone oxidoreductase. *J. Biotechnol.* 13 (2–3), 189–198.
- Arnaud, C., 2018. Bacterial enzyme packs its catalysis into one tiny chamber. *Chem. Eng. News* 96 (44), 7. October 31, 2018.
- Batog, J., Konczewicz, W., Kozłowski, R., Muzyczek, M., Sedelnik, N., Tańska, B., 2006. Survey and recent report on enzymatic processing of bast fibres. *J. Nat. Fibers* 3 (2/3), 113–129.
- Batog, J., Kozłowski, R., Przepiera, A., 2008. Activation of lignocellulosic composites by oxidizing enzymes. *For. Wood Technol.* 63, 28–31.
- Behrens, J., 1904–1906. Die Pektingärung Lafar's Handb. D. techn. Mycologie 3, 269.
- Bishop, D.P., Shen, J., Heine, E., Hollfelder, B., 1998. The use of proteolytic enzymes to reduce wool-fibre stiffness and prickly. *J. Text. Inst.* 89, 546–553.
- Breier, R., 2000. Rein enzymatische antifilzausrüstung von wolle nach dem Lanazym verfahren. *Meliand Textilberichte* 81 (4), 298–302.
- Bruhlmann, F., Kim, K.S., Zimmerman, W., Fiechter, A., 1994. Pectinolytic enzymes from actinomycetes for the degumming of ramie bast fibers. *Appl. Environ. Microbiol.* 60 (6), 2107–2112.
- Cavaco-Paulo, A., Almeida, L., 1994. Cellulase hydrolysis of cotton cellulose: the effects of mechanical action, enzyme concentration and dyed substrates. *Biocatalysis* 10, 353–360.
- Cavaco-Paulo, A., Cortez, J., Almeida, L., 1997. The effect of cellulase treatment in textile washing processes. *J. Soc. Dye. Colour.* 113, 218–222.
- Chesson, A., 1980. Maceration in relation to the post handling and processing of plant material. *J. Appl. Biotechnol.* 48, 1–45.

- Daniel, G., Volc, J., Kubatova, E., 1994. Pyranose oxidase, a major source of H₂O₂ during wood degradation by *Phanerochaete chrysosporium*, *Trametes versicolor*, and *Oudemansiella mucida*. Appl. Environ. Microbiol. 60, 2524–2532.
- Das, S., Indhumthi, V., Indupriya, M., Rajeev, K., September 2018. Studies on enzymatic treatment of cotton/bamboo knitted fabric. Colourage 33–36.
- Ding, R.-Y., Zhang, X.-Q., Yu, C.-W., 2014. Optimization of enzyme mixture degumming of ramie fiber. J. Nat. Fibers 11 (1), 13–24.
- Ehrlich, F., Schubert, F., 1926. Ueber die Chemie der Inkrusten des Flachses. Biochem. Z. 169, 13–66.
- El-Gabry, L., El-Nouby, G., Allam, O.G., El-Sayed, H., 2008. Effect of mechanical and enzymatic treatments on some properties of coarse wool. J. Nat. Fibers 5 (4), 461–475.
- Epps, H.H., Akin, D.E., Foulk, J.A., Dodd, R.B., 2001. Color of enzyme-retted flax fibers affected by processing, cleaning, and cottonizing. Text. Res. J. 71 (10), 916–921.
- Eriksson, K.E.L., 1990. Biotechnology in the pulp and paper industry. Wood Sci. Technol. 24 (1), 79–101.
- Evans, J.D., Akin, D.E., Morrison III, W.H., Himmelsbach, D.S., Foulk, J.A., 2002. Modifying dew-retted flax fibres by means of an air-atomized enzyme treatment. Text. Res. J. 72 (7), 579–585.
- Foulk, J.A., Akin, A.A., Roy, B., Dodd, R.B., 2007. Influence of pectinolytic enzymes on retting effectiveness and resultant fiber properties. BioResources 1 (1), 1–5.
- Freudenberg, K., 1964. Entwurf eines konstitutionsschemas für das lignin der fichte. Holzfor-schung 18, 3–9.
- Glasser, W.G., Glasser, H.R., 1981. The evaluation of lignins chemical structure by experi-mental and computer simulation techniques. Pap. Ja Puu 63, 71–83.
- Biotechnology in textile processing. In: Guebitz, G.M., Cavaco-Paulo, A., Kozłowski, R. (Eds.), J. Nat. Fibers 3 (2/3), 1–255. New York, London, Victoria: Haworth Press, Inc.
- Heine, E., Hollfelder, B., Hocker, H., 1995. Alternative wool treatment by means of enzymes and combined processes. In: The 9th International Wool Textile Research Conference, Biella, Italy, vol. III, pp. 247–254.
- Himmelsbach, D.S., Khalili, S., Akin, D.E., 2002. The use of FT-IR microspectroscopic map-ping to study the effects of enzymatic retting of flax (*Linum usitatissimum* L) stems. J. Sci. Food Agric. 82 (7), 685–696.
- Hohberg, T., Thumm, S., 1999. Finishing of lyocell – part 3. Melliland Int. 5 (1), 83–85.
- Hollfeder, B., Heine, E., Shen, J., Bishop, D.P., 2000. Parameters affecting the morphology of wool during enzyme treatment. In: The 10th International Wool Textile Research Con-ference, Aachen, vol. 26, p. 11, 1.12.
- Ibrahim, N.A., Hossamy, M.E.L., Nessim, A., Hassan, T.M., November, 2007. Performance of bio-degumming versus conventional degumming processes. Colourage 54 (11), 63–74.
- Inderpal, R., January 2004. Biotechnology and textiles. In special issue of Journal Colourage on Chemical Processing Colourage 25–28.
- Ivanov, A.N., Muravickaja, T.P., Ismailova, I.A., Osipora, M.V., Naumova, T.M., Judacva, L.V., 1984. Vlijanije promylenych sposobov prigotovenija tresty na chemiceskij sostar lnianych volokon. Technol. Tekst. Promyslennosti 6, 17–20.
- Iyer, N.D., 2004. Silk: the queen of textile fibres – V Chemical processing of silk. Colourage 51 (11), 77–78.
- Jayapriya, J., Vigneswaran, C., 2010. Process Optimization for biosoftening of lignocellulosic fiber with white rot fungi and specific enzymatic systems. J. Nat. Fibers 7 (1), 17–33.
- Jensen, N.P., 2000. Catalase enzyme. Text. Chem. Colorist Am. Dyest. Report. 32 (5), 23–24.

- Jin, L., Nicholas, D.D., Schultz, T.P., 1991. Wood laminates glued by enzymatic oxidation of brown-rotted lignin. *Holzforschung* 45, 467–468.
- Kasprzak, A., Pawuła, E., Czarnek, J., 1983. Chemical refinement of flax tow to adapt it to spinning in mixtures by unconventional methods. In: *Works of the Institute of Natural Fibres (IKWN)*, vol. 28, pp. 69–78.
- Kharazipour, A., 1991. Ensymgebundene holzwerkstoffe auf der basis von lignin und phenoloxidasen. *Adhasion Jg 35 (H.5)*, 30, 33–34, 36.
- Kharazipour, A., Huttermann, A., Kühne, G., Rong, M., 1993. Verfahren zum Verkleben von Holzfragmenten und nach dem Verfahren Hergestellte Formkörper. *European Patent DE 4305411*.
- Kim, J., Kwon, M.Y., Kim, S., 2016. Ecological degumming of silk fabrics with proteolytic enzymes. *J. Nat. Fibers* 13 (6), 629–639.
- Kochavi, D., Videback, T., Cedronii, D., 1990. Optimization processing conditions in enzymatic stone-washing. *Am. Dyest. Report.* 9, 24–28.
- Körner, S., 1990. Verfahren zur Stofflichen Modifikation des Rohholzes für die Holzwerkstoffherstellung. *Dissertation Technischen Universität Dresden, Germany*.
- Kozłowski, R., 1970. The Process of Flax Retting with Addition of Urea against Classical Method, with Special Regard to Volatile Fatty Acids in Post-Retting Liquor and in Shive, Excreted Gases and Nitrogen Compounds (Ph.D. thesis). *Institute of Natural Fibres, Poznan, Poland*.
- Kozłowski, R., Batog, J., Konczewicz, W., Kozłowska, J., Sedelnik, N., 2001a. Overview of current activities related to bioprocessing of bast plants, fibres and materials. Part I. *Nat. Fibres* 45, 85–92.
- Kozłowski, R., Batog, J., Konczewicz, W., Kozłowska, J., Sedelnik, N., 2001b. Overview of current activities related to bioprocessing of bast plants, fibres and materials. Part II. *Nat. Fibres* 45, 93–100.
- Kozłowski, R., Batog, J., Konczewicz, W., Mackiewicz-Talarczyk, M., Muzyczek, M., Sedelnik, N., Tańska, B., 2005. Latest state of art in bast fibers bioprocessing. In: *Proceedings of 11th International Conference for Renewable Resources and Plant Biotechnology*, 6–7 June, Poznan, Poland.
- Kozłowski, R., Batog, J., Konczewicz, W., Mackiewicz-Talarczyk, M., Muzyczek, M., Sedelnik, N., Tańska, B., 2006. Enzymes in bast fibrous plant processing. *Biotechnol. Lett.* 28 (10), 761–765.
- Mahapatra, N.N., June 2007. Use of enzymes in textile processing. *Colourage* 54 (6), 64–69.
- Mahmoodi, N.M., Arami, M., Mazaheri, F., Rahimi, S., 2010. Degradation of sericin (degumming) of Persian silk by ultrasound end enzymes as a cleaner and environmentally friendly process. *J. Clean. Prod.* 18, 146–151.
- Manickam, M.M., Prasad, J.G., 2005. Application of bio technology in textiles. *Colourage* 52 (10), 41–48.
- Marzullo, L., Cannio, R., Giardina, P., Santini, M.T., Sannia, G., 1995. Veratryl alcohol oxidase from *Pleurotus ostreatus* participates in lignin biodegradation and prevents polymerization of Laccase-oxidized substrates. *J. Biol. Chem.* 270, 3823–3827.
- Miettinen-Oinonen, A., 2007. Cellulases in the textile industry. In: *Polaina, J., MacCabe, A.P. (Eds.), Chapter 4 in Industrial Enzymes. Structure, Function and Applications*, pp. 51–63. ISBN 978-1-4020-5377-4.
- Mikulka, M., 2003. Charakterystyka Technologiczna Przemysłu Włókienniczego W Unii Europejskiej. Document elaborated for the Polish Ministry of Environment. Available from: http://ippc.mos.gov.pl/ippc/custom/PRZEM_WLOKIENNICZY.pdf.

- Moghe, V.V., Nabar, P.S., 2006. Bio scouring: an ecological way of scouring. *Colourage* 53 (2), 95–96.
- Murth, K.S., 2004. Role of enzymes in textile processing. *Colourage* 51 (6), 55–58.
- Muthu Manickam, M., Prasad, J.G., 2005. Application of bio technology in textiles. *Colourage* 52 (10), 41–52.
- Najafi, M.F., Deobagkar, D., Deobagkar, D., August 15, 2005. Potential application of protease isolated from *Pseudomonas aeruginosa* PD100. *Electron. J. Biotechnol.* 8 (2), 197–203.
- Ossola, M., Galante, Y.M., 2004. Scouring of flax rove with the aid of enzymes. *Enzym. Microb. Technol.* 34 (2), 177–186.
- Pedersen, G., 1994. *Enzymatic Treatment of Residual Bleach in Cotton Dyeing*. Draft UNEP Cleaner Production Worldwide Publication.
- Polak, J., Jarosz-Wilkolazka, A., 2007. Reakcje katalizowane przez lakaze – mechanizm i zastosowanie w biotechnologii. *Biotechnologia* 4 (79), 82–94.
- Puls, J., Tenkanen, M., Korte, H.E., Poutanen, K., 1991. Products of hydrolysis of beechwood acetyl-4-*O*-methylglucuronoxylan by a xylanase and an acetyl xylan esterase. *Enzym. Microb. Technol.* 13, 483–486.
- Riva, A., Cegarra, J., Prieto, R., 1993. The role of an enzyme in reducing wool shrinkage. *J. Soc. Dye. Colour.* 109, 173–228.
- Saddler, J.N., Penner, M.H. (Eds.), 1996. *Enzymatic Degradation of Insoluble Carbohydrates*, ACS Symposium Series 618. American Chemical Society. ISBN13: 9780841233416.
- Schilling, E., Muller, W., 1951. *Flax*. PWT, Warsaw, Poland.
- Schindler, W.D., Hauser, P.J., 2005. Finishing with enzymes: bio-finishes for cellulose. In: *Chemical Finishing of Textiles*. Woodhead Publishing, Cambridge, pp. 181–188.
- Schumacher, K., Heine, E., Hoecker, H., 2000. Enzymes in wool finishing effects on physical and chemical properties of the wool. In: *Proceedings of the 10th International Wool Textile Research Conference*, Aachen, vol. 26, p. 11, 1.12.
- Sedelnik, N., 1993. Biocarbo – metoda usuwania zanieczyszczeń roślinnych z tkanin wełnianych zgrzebných. *Przegląd Włókienniczy* 12, 294–297.
- Sedelnik, N., Latkowska, L., Sawicka-Żukowska, R., Zakrzewski, A., July 1, 1986. Sposób oczyszczania, tkanin z zanieczyszczeń roślinnych i innych celulozowych. UPRP, pp. 143–146. Bl(11).
- Sharma, S., 1988. Microorganisms in processing of flax. In: Rehm, H.J., Reed, G. (Eds.), *Biotechnology*. VCH Verlagsgesellschaft 6b, Weinheim, pp. 746–755.
- Shen, J., Bishop, D.P., Heine, E., Hollfelder, B., 1999. Some factors affecting the control of proteolytic enzyme reactions on wool. *J. Text. Inst.* 90, 404–411.
- Sójka-Ledakowicz, J., Gajdzicki, B., Lewartowska, J., Machnowski, W., 2000. Procesy enzymatyczne jako alternatywa dla tradycyjnych technologii wykończeniowych. *Przegląd Włókienniczy* 5, 28–31.
- Stohr, R., 1995. Enzyme biokatalysatoren in der textilveredlung. *Meliand Textilberichte* 76 (11), 1010–1013.
- Tabatabaie, G.R.S.M., Haghghat Kish, M., Salahshour Kordestani, S., 1996. Enzyme biopolishing of cotton fabric: effects of *Neurospora crassa* on cotton fabric properties. *Iran. J. Polym. Sci. Technol.* 9 (3).
- Tyndall, R.M., 1992. Improving the softness and surface appearance of cotton fabrics and garments by treatment with cellulase enzymes. *Text. Chem. Colorist* 24, 23–26.
- Vishnu Vardhini, K.J., Selvakumar, N., 2006. Biopolishing enzymes and their influence on the properties of cotton materials – a review. *Colourage* 53 (12), 45–52.

- Yaropolov, A.I., Skorobogatko, O.V., Vartanov, S.S., Varfolomeyev, S.D., 1994. Laccase: properties, catalytic mechanism and applicability. *Appl. Biochem. Biotechnol.* 49, 257–280.
- Zheng, L.-J., Du, B., Huang, X.-B., 2007. Research on pectase secreted by *Aspergillus niger* degumming kenaf bast fiber. *J. Donghua Univ.* 24, 404–407+412.

Further reading

- Akin, D.E., Henriksson, G., Evans, J.D., Adamsen, A.P.S., Foulk, J.A., Dodd, R.B., 2004. Progress in enzyme - retting of flax. *J. Nat. Fibers* 1 (1), 21–47.

Improving the properties of natural fibres by chemical treatments

8

*John A. Rippon*¹, *David J. Evans*²

¹Formerly CSIRO Materials Science and Engineering, Torquay, VIC, Australia; ²Formerly of CSIRO Materials Science and Engineering, VIC, North Melbourne, Australia

8.1 Introduction

Natural fibres have been used throughout the ages to handcraft materials essential for human life and there is a long history of modifying their properties to enhance their utility, durability and aesthetic appeal. Colouration is probably the earliest known example of fibre improvement and the discovery of ancient handcrafted textiles, dyed with natural dyes, illustrates that dyeing is as old as human civilization itself. In more recent times, advances in the knowledge of the fine structure and chemical composition of natural fibres has stimulated research and development into methods of improving their chemical and physical properties.

Methods of improving the properties of natural fibres generally use wet processing techniques, in which a chemical agent reacts with a water-swollen fibre. These reactions are, of necessity, heterogeneous and issues of transporting the reagent to the fibre, its reaction with the fibre surface and its penetration into the interior of the fibre are of major practical importance. Physical methods can also be used to enhance the properties of natural fibres and techniques, such as plasma and corona discharge, often used in association with wet chemical processes, have the potential to be useful additions to the wet processing methods currently available.

Chemical treatments applied to a fibre to achieve a specific effect often use similar reagents across a variety of fibres types; for example, the use of silicones or fluoropolymers to enhance water and stain repellency. In such cases, the chemistry of the finishing agent is often of more importance than the nature of the fibrous substrate. Other chemical treatments, however, depend on the unique chemical properties of the fibre, as for example in the various methods to decrease the felting of wool, which is responsible for the shrinkage of wool garments during washing. Felting is related to the surface friction of an assembly of fibres, but it is the chemical reactivity of the fibre surface that enables wet chemical treatments to be used to minimize shrinkage. Chemical treatments may, therefore, improve both the physical or chemical properties of the fibre. This review concentrates on chemical treatments that improve the most commercially important natural fibres. These include wool, cotton, silk and the common vegetable fibres. For each fibre, a brief review of the fine structure and chemical

composition relevant to the discussion is included. For more information on the structure of the natural fibres, readers are referred to other chapters and references included in this volume. Finally, we briefly review future trends for improving the properties of natural fibres.

8.2 Wool

Wool from sheep has been used as a textile fibre for thousands of years (Hyde, 1988; Ryder, 1987). Early breeds of wild sheep were covered in a brownish coat that was shed annually. Following domestication, selective breeding produced animals with finer wool and the off-white colour that we know today.

The various breeds of modern sheep produce a wide range of wool types, which are classified according to fibre length and diameter. Coarse wools are generally used in interior textiles, such as carpets and upholstery, and fine wools for apparel fabrics (Rippon, 2013a). The most important breed for producing fine wools is the merino, which typically produces wool that ranges in fibre diameter from 17 to 25 μm . This breed, which originated in Spain, has been developed to produce wool with highly valued properties of fineness, length, lustre, crimp and colour.

Raw wool usually contains 25%–40% of impurities, including wool grease, suint, dirt and vegetable matter, such as seed and burrs (Teasedale, 1988). Wool grease is composed of a mixture of esters and fatty acids. Suint, which arises from perspiration, is mainly composed of the potassium salts of fatty acids plus sulfate, phosphate and nitrogenous compounds (Truter, 1956). Wool grease, suint and dirt are removed by scouring (Stewart, 1985). In worsted processing, vegetable matter is removed by carding and combing (Harrowfield, 1987), whereas on the woollen system it is largely removed by carbonizing with sulfuric acid (von Bergen, 1970).

8.2.1 The physical and chemical structure of wool

Wool is a member of a group of proteins known as α -keratins (Rippon, 2013a). The basic structural units of proteins are amino acids, which have the general formula: $\text{NH}_2\text{CH}(\text{R})\text{COOH}$. The amino acid side chains (R) can consist of acidic, basic, non-polar or polar groups. Proteins are formed by condensation of amino acids via their amino and carboxyl groups to produce secondary amide bonds, called peptide bonds ($-\text{NHCH}(\text{R})\text{CO}-$). Multiple condensations produce linear polypeptides of high molecular weight.

The side chains present in the amino acids of wool polypeptides vary in size and chemical nature and play an important role in both the physical and chemical properties of the fibre (see Table 8.1). The non-polar hydrocarbon side chains are of low chemical reactivity, whereas the polar side chains of serine, threonine, aspartic acid and lysine are chemically more reactive.

Wool fibres consist of a complex mixture of approximately 170 different proteins (Zahn and Kusch, 1981), which are composed of 20 amino acids (Rippon, 2013a). Table 8.1 shows 18 amino acids because asparagine and glutamine are hydrolyzed

Table 8.1 Amino acid composition of wool.

Amino acid	Structure	Mol % ^a	Nature of side-chain
Glycine	CH ₂ (NH ₂)COOH	8.4	Non-polar
Alanine	CH ₃ CH(NH ₂)COOH	5.4	Non-polar
Phenylalanine	CH ₂ CH(NH ₂)COOH	2.9	Non-polar
Valine	CH ₃ CHCH(NH ₂)COOH CH ₃	5.6	Non-polar
Leucine	CH ₃ CHCH ₂ CH(NH ₂)COOH CH ₃	7.7	Non-polar
Isoleucine	CH ₃ CH ₂ CHCH(NH ₂)COOH CH ₃	3.1	Non-polar
Serine	HOCH ₂ CH(NH ₂)COOH	10.4	Polar
Threonine	CH ₃ CHCH(NH ₂)COOH OH	6.4	Polar
Tyrosine	HO CH ₂ CH(NH ₂)COOH	3.9	Polar
Aspartic acid	HOOCC ₂ H ₄ CH(NH ₂)COOH	6.5	Acidic
Glutamic acid	HOOCC ₂ H ₄ CH ₂ CH(NH ₂)COOH	11.9	Acidic
Histidine	CH ₂ CH(NH ₂)COOH	0.9	Basic
Arginine	H ₂ NCNH(CH ₂) ₃ CH(NH ₂)COOH	6.9	Basic
Lysine	NH ₂ (CH ₂) ₄ CH(NH ₂)COOH	3.0	Basic
Methionine	CH ₃ S(CH ₂) ₂ CH(NH ₂)COOH	0.5	Sulfur containing
Cystine	HOOCC ₂ H ₄ CH ₂ SSCH ₂ CH(NH ₂) COOH	10.3	Sulfur containing
Tryptophan	CH ₂ CH(NH ₂)COOH	0.5 ^b	Heterocyclic
Proline	COOH	6.6	Heterocyclic

^aMol % values are the mean values from Bradbury et al. (1965) and Leeder and Marshall (1982).

^bDetermined by enzyme digestion.

to the corresponding acids during dissolution of the fibre. Of the values for aspartic and glutamic acid in Table 8.1, approximately 60% of the amount shown for aspartic acid and 45% of the amount shown for glutamic acid is derived from asparagine and glutamine, respectively (Rippon, 2013a). The proteins range in molecular weight from less than 10,000 Da to greater than 50,000 Da (Lindley, 1977; Gillespie, 1990). The relative amounts of the amino acids in wool vary considerably between sheep breeds, between individual animals from the same breed and, sometimes, along the length of a

single fibre. Wool is a biological composite material in which the various polypeptides are not distributed homogeneously, but are concentrated in different regions of the fibre.

A characteristic feature of hard keratins, such as wool, horns, beaks and feathers, is a higher concentration of sulfur than is found in soft keratins, such as those in skin. The sulfur is present mainly in the form of cystine, which is formed during fibre growth from the amino acid cysteine by a process called 'keratinization'. The disulfide bonds of cystine form cross-links, which are mainly responsible for the greater stability and lower solubility of wool compared with other proteins (Ziegler, 1977). As shown in Fig. 8.1, these cross-links can either be inter-chain bonds between different protein chains or intra-chain bonds between different parts of the same chain.

In addition to disulfide bonds, the peptide chains in wool are held together and stabilized by the other covalent cross-links and non-covalent interactions shown schematically in Fig. 8.1. These include isopeptide bonds, which are formed between the ϵ -amino groups of lysine and the β - or γ -carboxyl groups of aspartic or glutamic acids, respectively. The ionized acidic carboxyl side chains of aspartic and glutamic acids can form strong electrostatic interactions ('salt linkages') with the ionized basic amino groups of histidine, arginine and lysine. The $-\text{CO}-$ and $-\text{NH}-$ groups in the peptide chains and the amino and carboxyl groups in the amino acid side chains can interact via hydrogen bonds. These bonds can also occur between donor and acceptor groups in the side chains of the amino acids. Salt linkages and hydrogen bonds contribute to the physical properties of dry wool fibres, but both are easily disrupted when the fibre is immersed in water (Rippon, 2013a).

The side chains of the proteins in wool fibres contain approximately equal numbers of basic amino and acidic carboxyl groups. These groups are responsible for the amphoteric properties of wool and its ability to combine with large amounts of acids or alkalis (Alexander and Hudson, 1963). As can be seen from Fig. 8.2, the concentration of ionic bonds, and hence their contribution to the properties of dry fibres, varies with pH. These groups are also important in dyeing because of their interactions with anionic dye molecules.

Another type of non-covalent interaction, often called a hydrophobic bond, occurs between hydrophobic groups present in amino acids, such as valine, phenylalanine and leucine. Unlike salt linkages and hydrogen bonds, hydrophobic interactions are not easily disrupted by water and are important in determining the properties of wet wool (Zahn and Blankenburg, 1964).

Although wool is classified overall as a keratin material, only around 82% of the proteins in wool contain sufficient cystine for them to be characterized as keratinous. The remaining proteins, which constitute around 17% of the fibre, have been termed 'nonkeratinous' because of their relatively low cross-link density compared with the true keratinous proteins (Zahn, 1980; Baumann, 1979). The nonkeratinous proteins of wool are more labile and susceptible to chemical attack than the keratinous proteins; for example, in processes, such as dyeing, bleaching and chemical shrinkproofing (Rippon, 2013a; Baumann, 1979).

In addition to proteins, wool fibres also contain approximately 1% by mass of non-proteinaceous material. This consists of lipids plus a small amount of polysaccharide

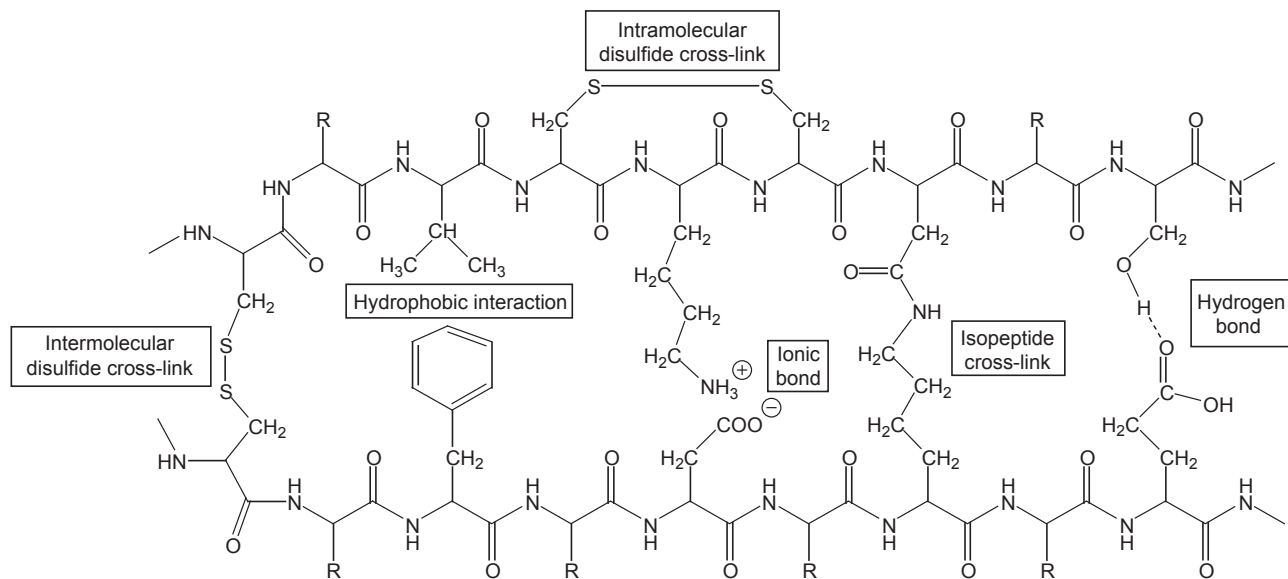

Figure 8.1 Covalent bonds and non-covalent interactions in wool.

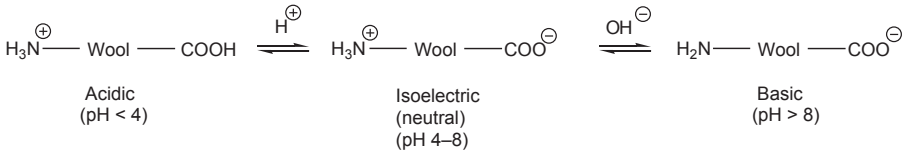

Figure 8.2 Amphoteric nature of wool.

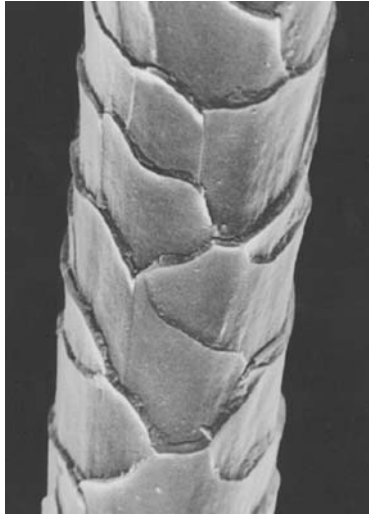

Figure 8.3 Scanning electron micrograph of merino wool fibre.

material. The nonkeratinous proteins and lipids are not distributed uniformly throughout the fibre, but are concentrated in specific regions (Rippon, 2013a; Rivett, 1991; Leeder, 1986).

Fine wool fibres from merino sheep consist of two types of cells (Rippon, 2013a; Jones et al., 1998). These are the internal cells of the cortex, which constitute around 90% of the fibre, and cuticle cells that form an overlapping sheath around the cortex (Fig. 8.3). One of the functions of cuticle cells in keratin fibres is to anchor the fibres in the follicles on the skin of the animal (Fraser et al., 1980; Fraser and Macrae, 1982). Cortical cells are approximately 100 μm long and 3–6 μm wide. They are spindle-shaped and arranged parallel to the fibre axis. Cuticle cells measure around 30 μm in length and 20 μm in width. The complex morphological structure of wool is shown in Fig. 8.4.

Cortical cells are composed of rod-like elements of crystalline proteins, called intermediate filaments (referred to as microfibrils in the older literature), that are approximately 7 nm in diameter and believed to be at least 1 μm in length (Gillespie, 1990; Bradbury, 1973). Cortical cells are surrounded by a region composed of relatively amorphous proteins, termed the matrix (Gillespie, 1990; Fraser et al., 1980; Orwin, 1979). This contains high-glycine/high-tyrosine proteins and it is also rich in proteins

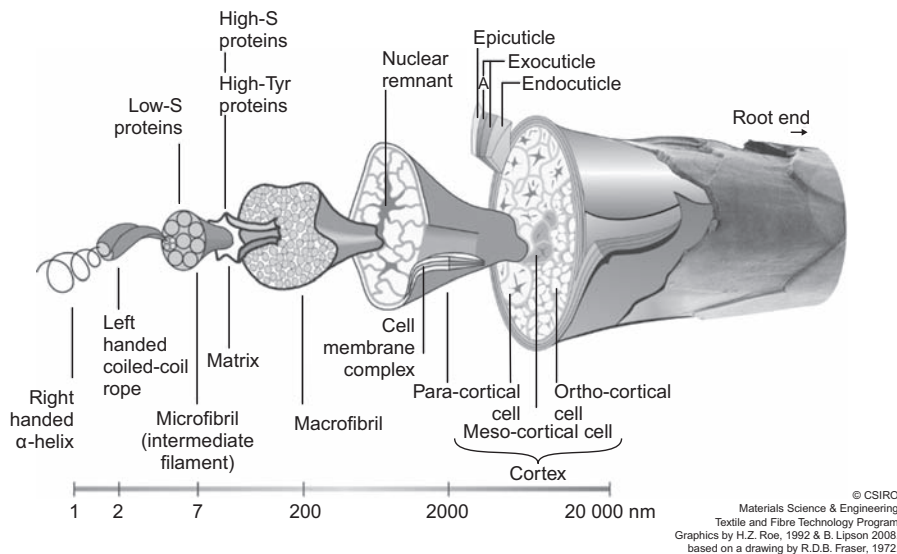

Figure 8.4 Schematic diagram of a merino wool fibre. Diagram courtesy of CSIRO.

that have relatively high sulfur content (Gillespie, 1990). The intermediate filaments, however, are rich in low-sulfur proteins (Jones, 1976), particularly those containing the amino acids that favour α -helix formation, such as lysine, leucine, aspartic acid and glutamic acid. The intermediate filaments are grouped together in aggregates, called macrofibrils, which are around $0.3 \mu\text{m}$ wide and range in length from $10 \mu\text{m}$ to the length of a cortical cell (Swift, 1977).

Fine wool fibres contain two main types of cortical cell (ortho and para). In merino fibres these are arranged bilaterally, whereas in coarser wools segmentation of the two types of cells is less distinct. The bilateral arrangement of cells in fine wools is responsible for the important property of crimp. This occurs because the ortho- and paracortex rotates around the fibre, with the orthocortex always orientated towards the outside of the radius (Mercer, 1954).

Cortical cells are separated from each other and cuticle cells are separated from the underlying cortex by the cell membrane complex (CMC). This is a continuous phase that extends throughout the whole fibre (Fig. 8.5). Whereas the bulk of the fibre consists mainly of keratinous proteins, the CMC contains a high concentration of relatively lightly cross-linked, nonkeratinous proteins (Leeder, 1986). Most of the internal lipids of wool are also located in this region (Rivett, 1991).

The CMC is particularly important in relation to abrasion resistance. When wool worsted fabrics are abraded during wear, fibre breakdown occurs as a result of torsional fatigue along the boundaries of the CMC (Leeder, 1986) and to a lesser extent along the intermacrofibrillar regions (Tester, 1984). This shows that the CMC is a region of relatively low mechanical strength. Furthermore, the comparatively low concentration of disulfide cross-links in the CMC makes it particularly susceptible to

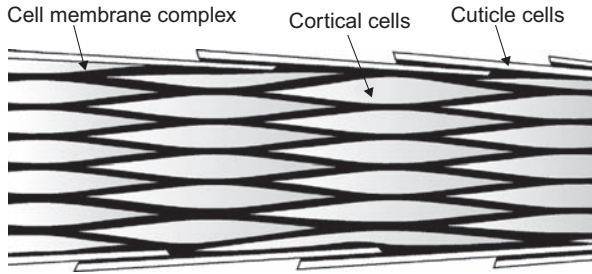

Figure 8.5 Schematic diagram of cortical cells within a merino wool fibre. Diagram courtesy of CSIRO.

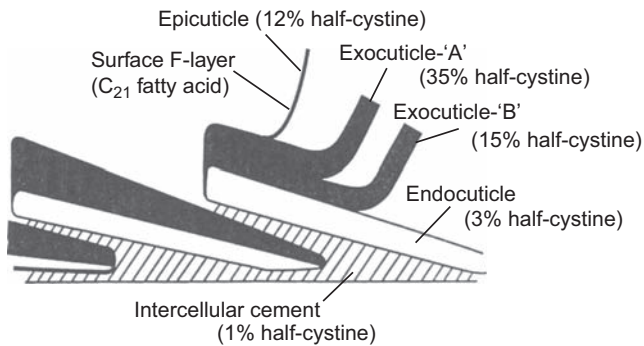

Figure 8.6 Schematic diagram of cuticle of wool. Diagram courtesy of CSIRO.

chemical attack during wet processing, which can adversely affect fabric abrasion resistance (Leeder, 1986; Feldtman and Leeder, 1984; Rippon and Leeder, 1986).

Cuticle cells have a number of sub-components, shown in Figs. 8.4 and 8.6. The endocuticle can be considered as a nonkeratinous region because it has a relatively low concentration of disulfide cross-links, compared with the whole fibre. In merino wool, the exocuticle constitutes approximately 60% of the total cuticle cell and is the most highly cross-linked component of wool, with approximately double the cystine content of the whole fibre. Each cuticle and cortical cell is surrounded by a membrane, which is around 3–6 nm thick and accounts for only 0.1% of the total fibre mass. These membranes are, however, relatively chemically inert as they are the last part of the fibre to dissolve when wool is digested in chemical reagents. The part of the membrane on the external surface of cuticle cells is termed the epicuticle. Although the epicuticle is proteinaceous, wool fibres that have been cleaned of grease remain hydrophobic. This property has been shown to be due to a lipid layer (F-layer), composed mainly of 18-methyleicosanoic acid and estimated to be around 0.9 nm thick, which is covalently bound to the surface of the epicuticle (Leeder and Rippon, 1985; Leeder et al., 1985a; Evans et al., 1985; Ward et al., 1993). The epicuticle and its layer of bound fatty acids, controls the surface properties of wool, such as friction, handle and wettability.

8.2.2 *Felting and shrinkproofing*

Wool fibres feel smoother than most other textile fibres and have a much lower coefficient of friction compared with, for example, nylon, silk or viscose rayon (Postle and Ingham, 1952). Wool is unique among the textile fibres in that it displays a directional frictional effect (DFE). This property, which also occurs with other animal fibres, results from the cuticle cells (scales), shown in Figs. 8.3 and 8.4, because de-scaled wool does not show a DFE (King, 1927). On the sheep, cuticle cells point from the root to the tip of each fibre and this results in the surface friction being greater when fibres are rubbed against the scales (from tip to root) than when rubbed with the scales (root to tip). The DFE assists in expelling dirt and other contaminants from the fleece (Fraser et al., 1980; Fraser and Macrae, 1982).

8.2.2.1 *Felting shrinkage*

Felting occurs when, under an applied force, fibres in a yarn, fabric or garment migrate preferentially in one direction, as a result of the DFE (Rippon, 2008; Makinson, 1979). Felting can occur in the dry state, particularly with fine wool, but it is more commonly found when wool is mechanically agitated in water. The earliest suggestion was that felting occurs by a ratchet mechanism resulting from interlocking of the scales (Alexander and Hudson, 1963; Makinson, 1979). This would require regular spacing of the scales and for the fibres to be parallel over a significant part of their length, neither of which is the case (Makinson, 1979). Furthermore, there is no experimental evidence for such a mechanism, as fibres with interlocked scales have never been found in felted wool (Alexander and Hudson, 1963). A ratchet mechanism can occur, however, without interlocking of the scales by interaction between the tips of the scales and asperities on the surface of another scale (Makinson, 1967, 1979; Makinson, 1979). When fibres are drawn against the scales, the tips of the scales deform and then recover as they slide past the asperities. When drawn in the with-scale direction, the scales on adjacent fibres become flattened on the surface and the fibres slide easily over each other.

The preferential migration of fibres, which occurs towards their root ends, produces entanglement in loose wool (Rippon, 2008). In fabrics and garments, shrinkage occurs which leads to a decrease in area and increase in thickness. This phenomenon is called ‘felting’ when the effect is undesirable, for example, when garments are washed. The terms ‘milling’, or ‘fulling’ are used when felting is carried out in a controlled manner to increase the density of fabrics by closing up the structure (Makinson, 1979; Moncrieff, 1953). Milling is used to produce a wide range of products, such as hats, military uniforms, overcoat fabrics, piano hammers and cloths for billiard tables.

In addition to the DFE, several other fibre properties also affect the extent of felting that occurs with untreated wool. These include fibre diameter, elasticity, length and crimp (Rippon, 2008). In general, products made from fine diameter wools felt more readily than those from coarse wools (Speakman and Stott, 1931). Of the other properties, elasticity is considered to be the most important (Speakman et al., 1933). Felting depends on the migration of fibres under the influence of external forces.

For this to occur, the fibres must extend and then recover from the extension. The felting ability of wool has been associated with the glass transition temperature (T_g) of the fibre (Pierlot, 1997). Felting rate increases with ease of extensibility and with factors that influence elasticity, in particular liquor pH and temperature (Speakman et al., 1933; Mitchell and Feughelman, 1967; Feldtman and McPhee, 1964).

8.2.2.2 *Shrink-resist treatments*

In order to prevent felting shrinkage during washing, it is necessary to overcome the DFE. This can be achieved by removing the scales, for example with an abrasive (Speakman and Whewell, 1945), or by treatment with oxidizing agents (Hojo, 1985) or enzymes (Levene and Shakkour, 1995). Removal of the cuticle cells reveals the underlying cortex, which is smoother and more lustrous than the surface of untreated fibres. De-scaling methods, however, remove a substantial amount of the fibre and are usually used only in the manufacture of shrink-resistant products where a high lustre is required (Rippon, 2008).

Where lustre is not required, felting shrinkage can be decreased by methods that do not remove all the cuticle cells. Current commercial treatments can be divided into three main categories:

- chemical treatment
- polymer treatment
- chemical treatment followed by application of a polymer.

The level of shrink-resistance obtained depends on the treatment used (Rippon, 2008). The highest level of shrink-resistance required for the Superwash product label is difficult to achieve by a chemical-only treatment. It can, however, be obtained on garments by either a polymer-only treatment or by a chemical treatment followed by a polymer. On wool tops, only a chemical plus polymer treatment can be used.

Chemical treatments are also called 'degradative' treatments, because they involve chemical attack on the fibre. Although treatment conditions have been optimized in an attempt to confine reaction to the fibre surface, some modification, or damage, usually occurs to the whole fibre. Chemical treatments include the use of oxidizing agents, reducing agents, alkalis and the use of a corona or plasma discharge (Rippon, 2008). Commercially, the two most important degradative treatments use either chlorination or permonosulfuric acid (PMS). Both techniques are used for the batch treatment of fabrics, garments and yarns, and also for the continuous treatment of tops (Anon, 1960, 1968; Cockett, 1979; Byrne, 1995; Connell, 2003).

Chlorination has been shown to reduce felting shrinkage by changing the surface friction of fibres via oxidation of disulfide bonds, in the highly cross-linked exocuticle, to cysteic acid groups (Speakman et al., 1938; Andrews et al., 1966; Schumacher-Hamedat et al., 1990). For shrink-resistance to be obtained some fission of peptide chains must also occur and this has been shown to take place primarily at tyrosine residues (Alexander et al., 1951a,b). The mechanism by which felting shrinkage is decreased by oxidation of disulfide bonds to cysteic acid residues, coupled with peptide bond hydrolysis, has been discussed by Makinson (Makinson, 1974). It involves

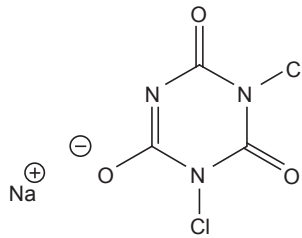

Figure 8.7 Structure of sodium salt of DCCA.

the generation of peptide fragments that are water-soluble because of the anionic cysteic acid groups. These fragments, which are too large to diffuse through the epicuticle membrane on the surface of the cuticle cells, allow the absorption of large amounts of water which swells the scales and makes them softer. The effect of this is an increase in the with-scale friction because the softer scales are more easily deformed. Although the against-scale friction is also increased to some extent, the net effect of chlorination is to decrease the magnitude of the DFE. This is the major factor by which chlorination reduces the felting shrinkage of wool. In addition to oxidation of disulfide bonds and hydrolysis of peptide chains, chlorination also removes covalently bound fatty acids from the fibre surface (Negri et al., 1992). Removal of these lipids, whilst also making some contribution to decreasing felting shrinkage by increasing inter-fibre friction, is also responsible for the harsh handle of chlorinated wool (Leeder and Rippon, 1985; Rippon, 2008).

Commercially, continuous treatments for chlorinating wool top require rapid reaction with the fibre. This is achieved either with acidic sodium hypochlorite (Anon, 1960), or by using chlorine gas dissolved in water (Byrne et al., 1984). When garments or fabrics are chlorinated by batch methods, an uneven treatment can be obtained if the rate of reaction between the chlorine and wool is too rapid. This problem is overcome by using dichloroisocyanuric acid (DCCA) as the chlorinating agent (Anon, 1968) (Fig. 8.7). Unlike acidic hypochlorite, the rate of release of chlorine from DCCA can be regulated by careful control of the treatment temperature and liquor pH. This ensures an even reaction with the wool substrate. Although mainly used for the batch treatment of garments, fabrics or yarn, DCCA can also be used for the continuous treatment of wool tops.

Following any type of chlorination, an 'anti-chlor' treatment is carried out with sodium sulfite to remove *N*-chloramines, formed by reaction of chlorine with amino groups in the wool (Maclaren and Milligan, 1981). It has been suggested that this treatment also contributes to the reduction in felting shrinkage obtained by chlorination, by further softening the scales as a result of increased porosity resulting from extraction of proteins rich in cysteic acid (Schumacher-Hamedat et al., 1990).

In addition to chlorine, other oxidizing agents have also been used to reduce the felting shrinkage of wool. The most important of these are potassium permanganate and peracids (Makinson, 1979; Maclaren and Milligan, 1981; Alexander et al., 1949). These chemicals have usually been used in the presence of concentrated

solutions of inorganic salts, in order to confine reaction to the fibre surface by suppressing fibre swelling (McPhee, 1960). In common with chlorination, permanganate treatment is believed to involve oxidation of cystine in the exocuticle to cysteic acid groups (Alexander et al., 1951c). Unlike chlorination, however, peptide bond fission at tyrosine residues does not occur. Furthermore, whereas chlorination increases friction in both the with-scale and against-scale directions, permanganate reduces the DFE by increasing the with-scale friction with little change in the friction against the scales (McPhee, 1960). This difference in the frictional changes resulting from chlorination and permanganate treatment has been claimed to be the reason for the softer handle of permanganate-treated wool, compared with the harsh handle of wool treated by chlorination, discussed above. It has also been suggested that permanganate-treated wool has a softer handle than chlorinated wool because it does not remove covalently bound surface lipids (Rippon, 2008).

Treatment with peracetic acid has also been used to reduce the felting shrinkage of wool. When used on its own, this acid is effective only at treatment levels that cause severe fibre damage (Alexander et al., 1951b; MCPhee, 1960). Lower concentrations that cause less fibre damage can be used, provided the oxidative step is followed by treatment with a reducing agent, such as sodium sulfite or bisulfite (McPhee, 1963). This step produces anionic Bunte salt groups in the A-layer of the cuticle, as shown in Fig. 8.8 (Douthwaite and Lewis, 1994).

Similar results are also obtained with PMS (HOOSO₃H). This reagent is preferred over peracetic acid for commercial use because it is less reactive and, therefore, easier and safer to handle. It also reacts more slowly with wool than chlorine, which makes it particularly suitable for use in batch processes (Byrne, 1995). As with peracetic acid, PMS treatment alone produces little change in either surface friction or shrink-resistance. Following an after-treatment with sodium sulfite or bisulfite, however, the frictional difference is decreased and felting shrinkage is reduced. The change in the DFE occurs because the with-scale friction is increased without affecting the against-scale value (McPhee, 1960).

PMS treatment is generally less effective than chlorination in reducing the felting shrinkage of wool (Makinson, 1979). Whereas chlorination produces cysteic groups in the cuticle, PMS followed by a reducing agent produces Bunte salt groups (Douthwaite and Lewis, 1994). Both these strongly anionic species will produce softening and swelling of the cuticle. Unlike chlorination, however, PMS does not generate the osmotically active peptide fragments which produce further softening of the cuticle in chlorinated wool (Makinson, 1974). PMS treated wool has a softer handle and lower wettability than chlorinated wool, which suggests a lower level of lipid removal and, therefore, a smaller effect on inter-fibre friction (Rippon, 2008). This difference in inter-fibre friction may also contribute to the greater effectiveness of chlorination compared with PMS treatment for shrinkproofing wool.

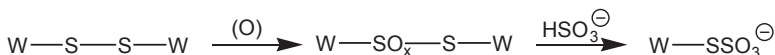

Figure 8.8 Scheme showing oxidation of disulfide bonds followed by bisulfite to generate Bunte salt groups. W, wool.

In addition to PMS, other treatments have also been extensively studied as alternatives to chlorination. Oxidation with ozone has been found to reduce the felting shrinkage of wool (Thorsen et al., 1979). The treatment oxidizes cystine to cysteic acid and decreases the DFE by decreasing both the with-scale and against-scale friction.

Corona treatment at atmospheric pressure, plasma under reduced pressure and recently at atmospheric pressure, has been widely studied as alternatives to chlorination in the continuous treatment of wool tops. In contrast to chemical treatments, which penetrate the fibre and cause degradation of the cortex, corona and plasma treatments are confined to the fibre surface. Felting shrinkage has been found to be reduced (Thorsen and Kodani, 1966; Rakowski, 1990) and a harsh handle produced (Rippon, 2008; Hesse et al., 1995). Unlike other treatments, the DFE is not decreased and the reduction in felting shrinkage has been found to be due to a large increase in both the with-scale and against-scale coefficients of friction, which prevents fibre migration in either direction. Surface analysis has shown that both corona and plasma treatment oxidizes cystine in the exocuticle to cysteic acid (Millard, 1975). Higher treatment levels also result in etching of the fibre surface (Klausen et al., 1995). Both treatments have been found to remove covalently bound fatty acids from the surface of the epicuticle, and this is responsible for the harsh handle and increased wettability produced by the treatments. The amount of lipid removed has been found to increase with treatment time and power input and this also corresponds to the extent of the change in wettability and resistance to felting shrinkage (Rippon, 2008; Merten et al., 1995).

A method of decreasing the felting shrinkage of wool that does not oxidize cystine to cysteic acid involves treatment with a solution of potassium hydroxide in dry ethanol (Lipson, 1947). This method was used commercially for several years. Both the with-scale and against-scale coefficients of friction are significantly increased, with little change to the DFE. This results in a decrease in felting shrinkage and a harshening of handle, with no visible change to the scale structure (Lipson, 1947). The harsh handle is consistent with the removal of surface lipids, because other alkaline reagents that specifically remove only surface lipids have been shown to also decrease felting shrinkage and produce a harsh handle (Leeder and Rippon, 1985).

8.2.2.3 Polymer treatments

The effect of the DFE in promoting felting shrinkage can be overcome by treatment with certain polymers (Rippon, 2008). These polymers reduce felting shrinkage by either forming fibre–fibre bonds or by masking the scales on the fibres. In both cases, fibres are prevented from migrating during washing (Makinson, 1979). A necessary requirement for both these mechanisms is that the polymer must spread on wool and adhere to the fibre surface. A liquid polymer will only spread on wool if the surface energy of the fibre is greater than that of the polymer. Due to the presence of the hydrophobic lipids of the F-layer, the surface of clean untreated wool has a very low surface energy (Rippon, 2008). This restricts the range of polymers that can be used unless the wool is pretreated to raise its surface energy above that of the polymer. Another requirement is that the adhesion between the polymer and the fibre must be

strong enough to survive multiple washing cycles. Commercial polymer treatments involve either polymer-only methods, used on untreated wool, or methods where a polymer is applied after the wool has been chemically treated (Rippon, 2008).

8.2.2.4 *Polymer-only treatments*

Polymer-only treatments are most commonly used on woven and knitted fabrics and on garments. The polymers are usually applied to fabrics by a pad-dry method. One important group of polymers, based on a poly(propylene oxide) backbone, have reactive groups that can undergo self-cross-linking reactions during the drying step, following application to the wool (Kilpatrick *et al.*, 1977). Reactive groups that have been used commercially in poly(propylene oxide)-based shrinkproofing polymers, include isocyanate ($-NCO$), carbamoyl sulfonate ($-NHCOSO_3^-$), thiol ($-SH$) and Bunte salt ($-SSO_3^-$). These polymers form bonds between fibres (also called 'spot welds'), which have the appearance of bridges (Kershaw and Lewis, 1976; Rippon and Rushforth, 1976). Commercially, the most important reactive group is carbamoyl sulfonate (Rippon and Rushforth, 1976; Guise, 1977).

Another group of polymers used for the treatment of fabrics are silicone elastomers. These have a lower surface energy than polymers based on poly(propylene oxide) backbones and spread readily on untreated wool. They tend to form a continuous layer on the fibre surface, which joins two or more fibres together (Makinson, 1975). Silicones are, however, not as effective as poly(propylene oxide) polycarbamoyl sulfonates unless the wool is pretreated before polymer application.

8.2.2.5 *Chemical treatment plus polymer: batch treatments*

Machine washable garments can be produced by batch chlorination treatment. The high level of chlorination required, however, produces an unacceptable level of fibre damage, which weakens the wool and produces a harsh handle (Cockett, 1979). This has led to the development of batch methods, in which the wool is given a low level oxidative treatment with either chlorine or PMS, followed by the application of a polymer.

The chlorination pretreatment is usually carried out with DCCA, because an even treatment can be obtained by regulating the rate of reaction with wool by careful control of temperature and pH. Although the chlorination treatment produces some resistance to felting shrinkage, its main function is to increase the surface energy and wettability of the wool by oxidizing cystine in the exocuticle to cysteic acid residues (Speakman *et al.*, 1938), and also by removing surface lipids (Negri *et al.*, 1992). The polymers used in batch treatments are cationic and are attracted to the fibre surface by the anionic cysteic acid groups (Byrne, 1995). The most widely used polymer is the polyamide/epichlorhydrin condensate, Hercosett 125 (Hercules Chemical Co.; Fig. 8.9). When cured on wool, this polymer can self-cross-link and also react with thiol and amino groups near the fibre surface (Lewis, 1977b; Earle *et al.*, 1970). Hercosett 125 is completely ineffective on untreated wool, because it does not spread on the fibre surface. It is, however, very effective in decreasing the felting shrinkage of

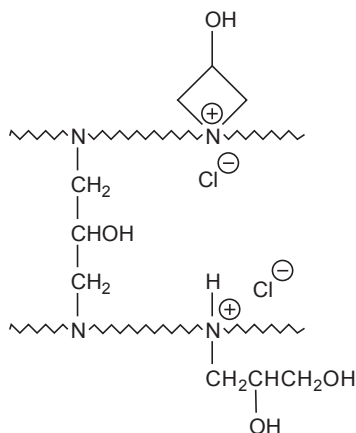

Figure 8.9 Chemical structure of Hercosett 125.

chlorinated wool by a mechanism that involves both fibre–fibre bonding and fibre encapsulation; the latter resulting in scale masking (Cockett, 1979; Kershaw and Lewis, 1976).

PMS can be used as an alternative to DCCA as a pretreatment in batch shrink-resist processes (Bereck et al., 1990; Byrne et al., 1995a). PMS is, however, not as versatile as chlorination because not all the polymers that can be used on chlorinated wool are effective following treatment with PMS. This is consistent with the greater effectiveness of chlorination compared with PMS in enhancing the spreading and adhesion of polymers by removing surface lipids, discussed above (Rippon, 2008).

8.2.2.6 Continuous treatment of wool top

Most machine washable wool products are made from fibres that are continuously treated in top form by a process developed by the Commonwealth Scientific and Industrial Research Organisation (Australia) (CSIRO) and the International Wool Secretariat (IWS) (Connell, 2003; Lewis, 1978). Parallel wool slivers are treated on specialized equipment at 5–10 m/min by the following series of steps:

Acid chlorination → anti-chlor → neutralize → rinse → polymer → softener
→ dry

Unlike batch treatments, polymers that rely on fibre–fibre bonding are unsuitable for application to wool top, because the bonds would be broken during subsequent processing of the top into yarn. Most of the shrink-resistance of wool treated in top form is believed to be due to the effect of the chlorination pretreatment step, via the effect on the DFE produced by softening of the scales (Makinson and Lead, 1973). The function of the polymer is to raise the level of shrink-resistance to meet the requirement for machine washability. The most common polymer used is the polyamide/epichlorohydrin resin, Hercosett 125 (Fig. 8.9). The scanning electron micrograph of a wool fibre



Figure 8.10 Scanning electron micrograph of wool fibre treated with chlorine/Hercosett.

treated by the chlorine/Hercosett process, in [Fig. 8.10](#), shows that individual fibres are encapsulated by the polymer. It has been shown that under the conditions used in laundering, the layer of resin swells to around five times its volume when dry ([Makinson and Lead, 1973](#)). At an application level of 2% on mass of wool of dry polymer, the level of swelling in water is sufficient to mask the scales. It has also been suggested that the swollen polymer also increases adhesion between the fibres. The overall result of these two effects is to decrease unidirectional fibre migration by reducing the difference between the with-scale and against-scale coefficients of friction from a value of 0.15–0.20 for untreated wool to a value below 0.04 ([Makinson and Lead, 1973](#)).

8.2.2.7 *Environmental issues of chlorination in wool shrinkproofing*

Treatment of wool with chlorine produces by-products formed by reaction of chlorine with protein material dissolved from the wool ([de Fries et al., 1983](#)). These compounds are collectively referred to as adsorbable organic halides (AOX). Concerns about the toxicity of these compounds and their release into the environment have led to legislation controlling their discharge from textile mills ([Müller, 1992](#)). This has resulted in much research over the past 20 years to find alternatives to chlorination as a pretreatment for polymers. PMS, although very effective for the batch treatment of garments, is unsatisfactory for use in the continuous treatment of top, which is the route used to produce the majority of machine washable wool. The effectiveness of PMS has been enhanced by co-treatment with hydrogen peroxide, in the presence of a metal catalyst ([Connell and Huddleston, 1997](#)). Oxidation with potassium permanganate, followed by treatment with an enzyme, has also been claimed to be an effective pretreatment ([Haefely, 1989](#)). A process currently used in Japan involves pretreatment with ozone,

followed by application of Hercosett (Ichimura et al., 2001). The feasibility of a plasma pretreatment for polymers has also been widely studied. None of the polymers that are effective on chlorinated wool are, however, effective on plasma-treated top (Rakowski, 1990) and to date no new polymers have been identified that will produce full machine washability (Rippon, 2008).

8.2.3 Setting

Setting is an operation used to stabilize yarns and fabrics by removing stresses introduced during manufacture (Rippon et al., 2016; Brady, 1997). These stresses would otherwise cause problems during processing, such as twisting and snarling of yarns during winding and warping, or distortion of fabrics during wet treatments. Yarns are set by steaming before weaving or knitting. Fabrics are often set in steam or hot water before wet treatments, such as dyeing. Fabrics can also be flat set near the end of a finishing sequence to impart dimensional stability and produce the required handle. Garments are set by pressing in steam to impart the required shape and to insert creases and pleats. Setting is a process of stress relaxation and can involve either cohesive (temporary) set or permanent set. These are differentiated by their stability to relaxation in hot water. Set that is retained after 15 min in water at 70°C is considered to be permanent, whereas temporary set is completely lost under these conditions (Rippon et al., 2016; Brady, 1997). These conditions have been selected because they are considered to be more severe than when encountered by a wool garment during use and cleaning.

During setting, the protein structure of wool is rearranged and the fibres are stabilized in a new configuration by various types of interactions and chemical bonds. Temporary set involves stabilization via hydrogen bonds and ionic interactions, such as those shown in Fig. 8.1. Although providing stability under ambient conditions, these non-covalent interactions are disrupted in water or under conditions of high relative humidity. Permanent set involves the rearrangement of covalent bonds, the most important of which are disulfide cross-links (Fig. 8.1). This occurs by a mechanism of thiol/disulfide interchange (Fig. 8.11) (Burley, 1955).

The rate of setting can be increased by facilitating the fission of disulfide crosslinks, for example by increasing the pH or with a reducing agent. Increasing the temperature and moisture content (regain) of the wool also increases setting rate by increasing the mobility of the protein chains, thus making it easier for them to adopt new lower energy configurations. At elevated temperatures, hydrophobic interactions between adjacent hydrophobic side-chains, such as those of amino acid residues derived from valine, phenylalanine and leucine, can also rearrange. These contribute to the stability of permanently set wool because they are not readily disrupted in water (Zahn and Blankenburg, 1964; Asquith and Puri, 1968).

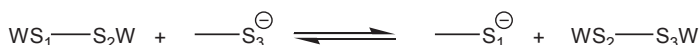

Figure 8.11 Thiol-disulfide interchange reaction involved in the permanent setting of wool. W, wool.

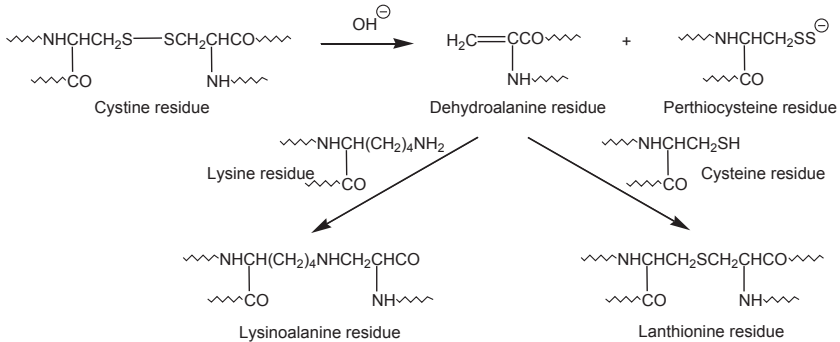

Figure 8.12 Formation of lantionine and lysinoalanine cross-links during the permanent setting of wool.

During setting, particularly under alkaline conditions in the presence of reducing agents, in addition to regeneration of disulfide bonds, as shown in Fig. 8.11, new types of cross-links are also formed from some of the original disulfide cross-links. The most important of these are lantionine and lysinoalanine bonds (Fig. 8.12) (Ziegler, 1965). These bonds, which are more stable than disulfide cross-links, make an important contribution to the stability of permanently set wool.

The most important method of wet permanent setting is ‘crabbing’, which is done to stabilize a fabric before dyeing (Brady, 1997). The highest levels of set, of around 40%–85%, are obtained by batch crabbing. This involves treating a fabric, rolled onto a cylinder, in boiling water for several minutes and then cooling the fabric in cold water. Fabrics can also be set by a continuous crabbing method. In this, a wet fabric is sandwiched between a heated roller and an impervious belt. The temperature of the fabric is maintained in excess of 100°C for around 1 min, before being quenched in cold water. Although this procedure has a higher productivity than the batch method, it gives a lower level of set. The rate of setting in a continuous crabbing machine can be increased by adding a reducing agent, such as monoethanolamine sulfite [1%–3% on mass of fibre (omf)], to the wetting bath.

As part of a finishing operation, fabrics may also be set by ‘decatizing’. In this process, the fabric is interleaved with a cotton or cotton/synthetic wrapper and wound onto a perforated drum. After blowing steam through the batch for up to 10 min, the fabric is cooled by drawing through a stream of cold air. This treatment imparts relatively little permanent set (up to 40%). Higher levels of permanent set are obtained by steaming the batch under pressure in an autoclave for 3–5 min at 120–130°C.

An important example of the use of reducing agents to set wool is the Siroset Process (Farnworth and Delmenico, 1971), which is used to insert permanent creases and pleats in wool garments. This involves spraying the garments with a reducing agent, such as monoethanolamine bisulfite, followed by pressing using a steam/bake cycle of up to 60 s.

8.2.3.1 OPTIM – a new textile fibre made from wool

The ability of wool to be permanently set in a new configuration has been exploited in the production of OPTIM Fine, a new fibre made from wool (Bhoyro et al., 2001). In the manufacture of OPTIM Fine, wool fibres that have been pretreated with a reducing agent, such as sodium bisulfite, are simultaneously stretched and set on specialized equipment. Fibre cohesion is maintained during the continuous process by using false twist. The stretched fibres are permanently set by steaming. Stretching and setting wool fibres changes the intermediate filaments in the cortex from an α -crystallite form to that of a β -pleated sheet, similar to that of silk (Bendit, 1960). Stretching decreases the diameter of the fibres: typically 19 μm wool stretched by 40%–50% has a diameter of around 15–16 μm . The false twist applied to prevent fibre slippage imparts a large transverse force to the twisted top. This changes the almost circular cross-section of the parent wool to the irregular cross-section shown in Fig. 8.13, in

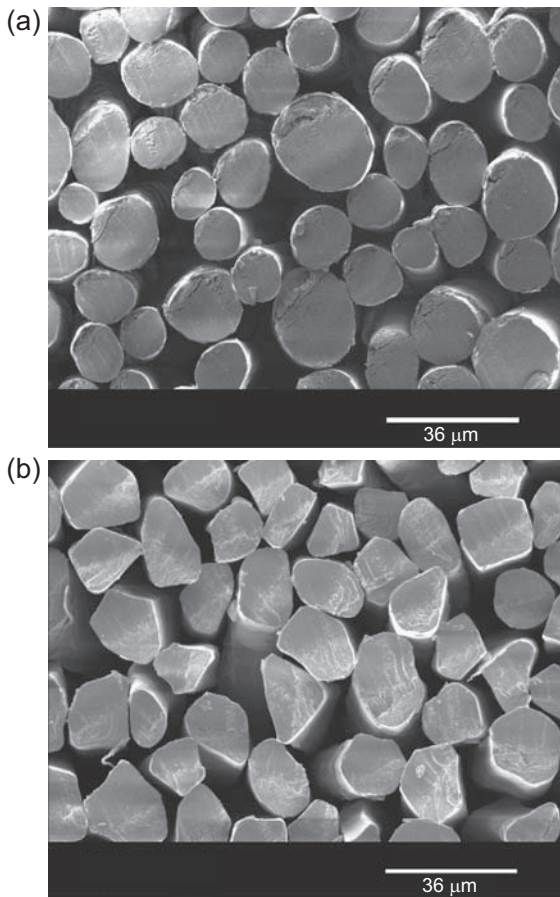

Figure 8.13 Cross-section of (a) wool and (b) OPTIM.

which there is a high proportion of fibres with flat surfaces. This change in cross-section is responsible for the high lustre of OPTIM Fine, compared with the parent wool. OPTIM Fine fibres are also stronger than the parent wool and are ideal for spinning into fine yarns, which can be used for the production of fabrics with similar aesthetic properties to silk. They are also used in combination with other high value fibres, such as alpaca and cashmere, to make products where softness, lightness and lustre are required.

The equipment used to manufacture OPTIM Fine can also be used to produce a variant called OPTIM Max. Whereas OPTIM Fine is permanently set in the stretched configuration, OPTIM Max fibres are temporarily set while stretched. This is achieved by omitting the sodium bisulfite reducing agent and controlling the steaming time. OPTIM Max fibres retract by around 25% in length when the temporary set is released under hot, moist conditions. This enables yarns of high bulk to be produced by blending OPTIM Max with normal wool. When yarns spun from the blend are relaxed in hot water, retraction of the stretched fibres causes the normal wool fibres to buckle, thus increasing the volume of the yarn. This effect results in an increased cover in knitted fabrics and can be used to make products that are 20%–30% lighter than products, with a similar cover factor made, from normal wool yarns.

8.2.4 Dyeing

The colour of a textile product is arguably the most important property that influences purchase by a consumer. As mentioned in [Section 8.2](#), the early types of wild sheep were covered in a brownish coat ([Ryder, 1987](#)). The discovery of dyeing probably led to a demand for whiter wools, which was achieved by selective breeding of sheep. The exact date at which this happened is not known, but fragments of dyed wool cloth have been found dating back several thousand years. The earliest methods of dyeing wool used materials derived from plants and animals (natural dyes). These have now been largely replaced by dyestuffs made in chemical factories (synthetic dyes).

8.2.4.1 Natural dyes

Before the synthesis of mauveine from aniline by Perkin in 1856 ([Holme, 2006](#); [Garfield, 2000](#)), the only materials available for the colouration of textiles were obtained from plants or animals. For example, Grierson has listed some of the plants used in the dyeing of Scottish woollen tartan fabrics ([Grierson, 1984](#)). In many cases, extraction of dyes from natural sources was a labour-intensive process, often producing low yields of active materials. Thus, extraction of the root of the madder plant to give the important red dye, alizarin, gave a yield of only 1% of active material ([Holme, 2006](#)). An example of a colourant obtained from an animal is cochineal, for which 150,000 insects are required to produce 1 kgm of dye ([Glover and Pierce, 1993](#)). Other disadvantages of many natural dyes are lack of stability or suitable fastness properties. Following Perkin's discovery of mauveine, other synthetic dyes were soon made,

many of which were found to be brighter, have higher tinctorial strength, better fastness properties and be more reproducible in their application than natural dyes. Furthermore, the introduction of synthetic dyes came at a time when the textile industry was rapidly expanding, which produced a greatly increased demand for dyestuffs that could not be easily met from natural sources. The use of synthetic dyes grew rapidly and by the 1890s they accounted for more than 90% of the total amount of dyestuffs used.

Over the past few years, there has been some renewed interest in using natural dyes. This has been driven by a perception that dyes from natural sources are less toxic and more environmentally friendly than synthetic dyes. As discussed in several reviews on natural dyes, this view is not necessarily justified (Glover and Pierce, 1993; Hill, 1997; Glover, 1998). Among the disadvantages of natural dyes is possible toxicity. Whereas synthetic dyes are stringently tested for toxicity before they are allowed to be used, very little work has been done on the toxicity of natural dyes. Regarding the environmental aspects of using natural dyes, the cultivation of plants from which they are extracted requires large areas of land, water, chemical fertilizers and possibly pesticides, which could otherwise be used to grow food. In 1998 it was estimated that to produce enough natural dyestuffs to colour the global production of wool and cotton would require 462 million hectares of land, which was then equivalent to 31% of the world's available agricultural land (Glover, 1998).

In their application to protein fibres, many natural dyes require a mordant to fix the dye to the substrate. Mordants are mostly industrially manufactured inorganic compounds and include the salts of copper, chromium, iron, zinc and aluminium. In general, the uptake of these salts by the fibres is not very efficient and around 50% of the amount used can remain in the effluent, resulting in levels that greatly exceed the concentrations allowed by water authorities for discharge to sewers (Glover and Pierce, 1993). The tinctorial properties of natural dyes can depend on growing conditions, such as rainfall and soil type. This makes them unsuitable for use in commercial dye-houses, where the very high levels of shade reproducibility required are easier to achieve with synthetic dyes of reproducible dyeing properties. There is also a large difference between the cost of using natural and synthetic dyes, partly due to the lower colour strength of most natural dyes and partly because of the expense of using a mordant. In the case of wool, the cost difference has been estimated to be around one hundred-fold (Glover, 1998).

Natural dyes do not offer a viable alternative as replacements for synthetic dyes for the large-scale colouration of the protein fibres, wool and silk. They will, however, continue to occupy a niche segment of the market in areas where consumers want totally 'naturally derived' products, and in the craft area, particularly where a wide shade range and high fastness properties are not important. A significant expansion in the use of natural dyes for the large-scale production of protein fibres would, however, require a large increase in the availability of products with a wide range of shades, with overall fastness properties approaching those of comparable synthetic dyes. Also, methods are required that avoid the use of mordants containing toxic metals.

8.2.4.2 Synthetic dyes

The majority of dyes used to colour wool are sodium salts of aromatic anions. Water solubility is conferred by sulfonic acid groups or in a few cases by either carboxyl groups or hydrophilic, nonionic substituents (Rippon et al., 2016; Lewis and Rippon, 2013). Wool is usually dyed commercially by batch methods from acidic aqueous solutions, as loose fibre, sliver (top), yarn, fabric or as garments, at liquor:wool ratios of between 10:1 and 60:1 (Hawkes and Hamilton, 2013). In a typical cycle, the temperature of the dyebath is slowly increased from around 40°C to the boil, where it is maintained for times ranging from around 30 min to over 2 h, depending on the dye type and depth of shade.

As shown in Fig. 8.2, wool is an amphoteric material. Early theories of wool dyeing attempted to explain the mechanism of dye uptake under acid conditions in terms of electrostatic interactions between the positively charged amino groups on the fibres and negatively charged dye anions (Alexander and Hudson, 1963). Later workers showed, however, that other types of interactions are also responsible for the affinity and wet fastness properties of dyed wool (Lewis, 2008; Rippon, 2013b). These include van de Waals' forces, hydrogen bonds and interactions between hydrophobic parts of the dye molecules and hydrophobic regions in the fibre arising from the non-polar side chains of amino acids, shown in Fig. 8.1 (Meybeck and Galafassi, 1970). Dyes differ widely in hydrophobic/hydrophilic character (Rippon et al., 2016; Rippon, 2013b). Ionic interactions are of most importance for dyes of relatively low molecular weight, whereas other interactions, such as van de Waals' forces and hydrophobic interactions, become increasingly important with increasing molecular weight of the dye. This is reflected in the generally higher affinity and, hence, better wetfastness properties of higher molecular weight dyestuffs. Ionic interactions are important, however, in attracting the dye molecules to the surface of wool. The rate of dye uptake can be controlled by varying the amount of acid added to the dyebath because, as shown in Fig. 8.2, the net positive charge on the wool increases with decreasing pH.

Wool dyes are divided into the following groups: acid dyes, chrome dyes, pre-metallized dyes and reactive dyes (Rippon et al., 2016; Lewis and Rippon, 2013; Lewis, 2008). Several types of acid dyes are used on wool: levelling acid dyes, half-milling dyes, milling dyes and super-milling dyes (Duffield, 2013). Levelling acid dyes have relatively low molecular weights (300–600 Da). The structure of a typical disulfonated azo levelling acid dye is shown in Fig. 8.14. Other dyes in this group may contain one, three or four sulfonic acid groups. The number of these

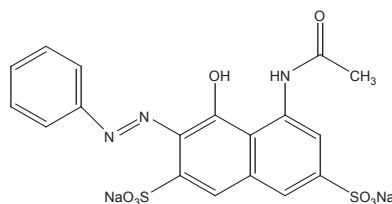

Figure 8.14 Structure of a typical acid levelling dye (Acid Red 1).

moieties affects the hydrophilic/hydrophobic balance of the dye. Another important type of levelling acid dye is based on an anthraquinone structure. Levelling acid dyes are easy to apply evenly at low pH (*ca.* pH 3), but have relatively poor wetfastness properties because they rely mainly on ionic interactions with wool.

Milling dyes have higher molecular weights (600–900 Da) and more complex structures than levelling dyes. They generally contain fewer solubilizing groups and often have a hydrophobic side chain, such as a dodecyl group, on the aromatic ring. They form stronger hydrophobic interactions with wool and have a lower dependence on ionic interactions than levelling dyes. Although this gives them better wet fastness properties, they are more difficult to apply evenly because they have poorer migration properties than levelling dyes. Level results are obtained by slowing the rate of uptake by using a dyebath pH in the range of 4.5–6.5 (depending on the particular dyes) and addition of a levelling agent.

Chrome dyes are acid dyes (mol. wt. 300–600 Da) that contain groups capable of forming complexes with chromium (Lewis, 2008; Duffield, 2013). The dye/chromium complex has much better fastness than the parent dye. Modern practice is to apply the dye by a similar method to a levelling dye and then form the chrome complex in a separate step. Chrome dyes are relatively cheap and have excellent fastness properties, which has made them popular for black and navy shades. Their use has, however, declined in recent years because of damage to the wool from both the prolonged cycles and oxidation of the fibre in the chroming step. There are also increasing environmental concerns about the use of chromium.

In many applications, chrome dyes have been replaced by pre-metallized dyes (Lewis, 1977a; Burkinshaw, 2013). With pre-metallized dyes, the metal complex is formed during the manufacture of the dye, by reacting a chromium or cobalt atom with either one or two dye molecules. These are called 1:1 and 1:2 metal complex dyes, respectively (Fig. 8.15). The 1:1 metal complex dyes are applied at low pH (around pH 2), whereas the 1:2 complexes are applied at pH 5–7. Both types have very high affinity for wool because of their high molecular weights (700–1000 Da) and very high hydrophobic character.

Reactive dyes are becoming more important for dyeing wool because of concerns over the use of heavy metals, such as chromium, in the textile industry (Lewis, 2008, 2013b). Reactive dyes usually contain two or three sulfonic acid groups and have molecular weights in the range 500–900 Da. They also contain one or more groups that can form covalent bonds with the side chains of the amino acids in wool, in particular amino, thiol and hydroxyl groups (Lewis, 2008, 2013b). One type of reactive dye commonly used on wool contains a bromoacrylamido group (Fig. 8.16). Other important reactive groups used in wool dyes include 5-chloro-2,4-difluoropyrimidyl and β -sulfatoethyl sulfone. The formation of covalent bonds between the dye molecules and wool fibres results in very high wetfastness properties, which makes reactive dyes particularly suitable for use on shrink-resist treated wool. Reactive dyes have moderate migration properties, provided they are applied with careful control of pH and an amphoteric levelling agent (Lewis, 2008).

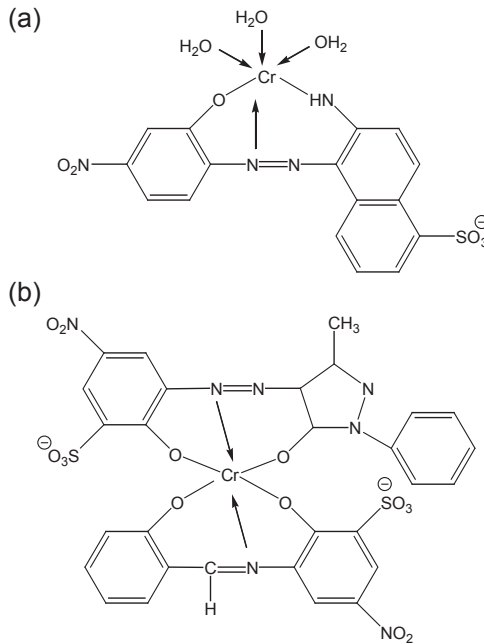

Figure 8.15 Structure of typical metal complex dyes. (a) A 1:1 metal complex (Acid Green 12) and (b) a 1:2 metal complex (Acid Orange 148).

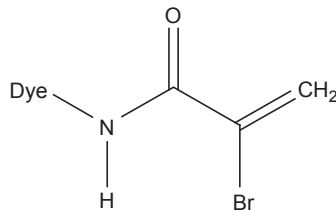

Figure 8.16 General structure of bromoacrylamido reactive dye.

8.2.4.3 Effect of fibre structure on dyeing

As early as 1908, Bowman observed that wool fibres tended to dye to a deeper shade at the junctions where the scales overlap (Bowman, 1908). Bowman did not, however, interpret this observation in terms of the diffusion pathways of dyes into wool. Later, in 1937, Hall stated that ‘dyes gain access to the interior of the fibre via the junctions between the scales’ (Hall, 1937). Despite these observations, studies on the kinetics of dye uptake led to a general belief that dyes reach the fibre cortex by diffusing through the cuticle cells across a barrier associated with the fibre surface (Rippon, 2013a,b). The barrier has been variously ascribed to the epicuticle, the whole cuticle and the highly cross-linked A-layer of the exocuticle. The relationship between fibre structure and dyeing properties has now been clarified, following work by CSIRO

(Rippon, 2013b). This involved specially synthesized dyes that could be located inside the fibre with the electron microscope, at different stages of the dyeing cycle (Leeder et al., 1985b). It was shown that, in agreement with Hall's observations using the light microscope, dyes enter the fibre at the junctions of the cuticle cells. It was also shown that diffusion then occurs along the nonkeratinous regions of the endocuticle, the CMC and intermacrofibrillar material. As the dyeing cycle proceeds, the dyes progressively transfer from the nonkeratinous regions into the sulfur-rich hydrophobic matrix proteins surrounding the intermediate filaments within the cortical cells. Dye also transfers from the nonkeratinous endocuticle into the highly cross-linked A-layer of the exocuticle. Thus, it appears that, at equilibrium, the affinity of dyes for wool is largely dependent on hydrophobic interactions between dye molecules and the hydrophobic proteins within the matrix material of the cortical cells and in the A-layer of the cuticle. The results also explain why a prolonged period at elevated temperature is required after the dyebath is exhausted to produce dyed wool with good fastness properties (Leeder et al., 1985b, 1990). If dye remains mostly in the nonkeratinous regions, rapid diffusion out of the fibre can occur, resulting in poor wetfastness properties. These findings have been confirmed by studies involving fluorescence microscopy (Brady, 1990). Light microscopy has also been used to show the importance of nonkeratinous regions in the diffusion of surfactants (Holt and Stapleton, 1988) and simple nonionic compounds (Holt and Saunders, 1986) into wool. It was concluded from these studies that the A-layer of the exocuticle is a barrier to transcellular diffusion across cuticle cells, but that, in unmodified wool, dyes find an easier route into the fibres by an intercellular pathway. The above discussion relates to the application of nonreactive dyes to wool. Reactive dyes may, however, show a different equilibrium distribution between the nonkeratinous and keratinous regions of the fibre, because they can form covalent bonds with proteins in the nonkeratinous regions early in the dyeing cycle (Lewis and Smith, 1990). Thus, at equilibrium, reactive dyes may be present in the CMC and endocuticle to a greater extent than their nonreactive analogues (Lewis, 2008).

The above discussion on the diffusion between cuticle cells as a preferred pathway for initial dye penetration into wool relates to unmodified fibres. Wool that has been physically or chemically modified may, however, show a different mode of dye penetration. Effective treatments include removal of the A-layer barrier by chemical reduction or severe surface abrasion (Hampton and Rattee, 1979), or by complete removal of the cuticle cells (Hojo, 1985; Hori and Zollinger, 1987). Depending on the type and level of treatment, these modified wools may also show transcellular diffusion of dyes across the cuticle cells at a comparable rate to the intercellular diffusion shown by unmodified fibres.

The effect of chlorination on dyeing properties is particularly important because this treatment is used to make wool resistant to felting shrinkage. Chlorination does not significantly affect the equilibrium dye uptake (Barritt and Elsworthy, 1948) but the rate of dye uptake is increased (Townend, 1945).

In addition to its use in shrinkproofing, chlorination is also used as a pretreatment for printing (Broadbent and Rigout, 2013). The increased colour yield of wool prints resulting from a pre-chlorination treatment is due to the large increase in wettability produced by removing a high proportion of the covalently bound surface lipids, as

discussed above. It has been found, however, that when all the covalently bound surface lipids were removed without any further modification of cuticle or cortical cells, transcellular diffusion of dyes did not occur in long liquor dyeing (Leeder et al., 1985a). This finding supports the hypothesis that the highly cross-linked A-layer of the exocuticle, not the lipids of the F-layer, is the barrier to transcellular dye diffusion. It was found that removal of lipids from the junctions between the scales did increase both the rate and evenness of dye uptake by the transcellular route. Thus, it appears that lipids located at the scale junctions also act as a barrier to the entry of dyes into wool.

Some workers have claimed that plasma treatment improves the dyeing properties of wool, including improved dyebath exhaustion and shorter dyeing cycles (Thomas, 2007). Other studies, using a range of dyes, have, however, found that plasma-treated wool has similar dyeing properties to untreated wool, in respect of rate of dye uptake, equilibrium exhaustion and depth of shade (Byrne et al., 1995b). It appears that the effect of plasma treatment on the rate of dye uptake is dependent on the hydrophilic/hydrophobic nature of the dye. This is consistent with the effect of plasma treatment in increasing the wettability of the wool surface by removing bound lipids, thus exposing the underlying hydrophilic protein material, and also its effect in oxidizing cystine to cysteic acid residues (Naebe et al., 2010b). When plasma-treated wool is dyed in the absence of levelling agent, the plasma treatment has little effect on the adsorption rate of relatively hydrophobic, sulfonated wool dyes (Naebe et al., 2010b). This is consistent with the greater importance of hydrophobic dye–fibre interactions compared with electrostatic (ionic) effects in those cases. For relatively hydrophilic dyes, however, the rate of dye uptake is increased by plasma treatment, which is consistent with the greater importance of electrostatic interactions between the more strongly anionic, hydrophilic dye molecules and a more highly charged, hydrophilic fibre surface. As discussed above, similar effects have been found for wool that had been made more hydrophilic by chlorination. It has also been shown that when plasma-treated wool is dyed under commercial conditions, in the presence of a levelling agent, then even hydrophilic dyes show similar rates of uptake on both untreated and plasma-treated wools (Naebe et al., 2010a). It should be noted that, because the plasma treatment affects only the surface of the cuticle cells, these effects on dye uptake relate only to sorption of dye on the surface of cuticle cells and not to diffusion into the cortex. Höcker et al. (1994) have shown that a severe plasma treatment produces considerable oxidation of the cystine in the A-layer of the exocuticle and that this can result in transcellular diffusion of dye. Under the milder conditions used by most workers, however, although plasma treatment enhances the uniformity of dye adsorption, the intercellular diffusion pathway shown by untreated wool also occurs following plasma treatment (Naebe et al., 2010b).

The dyeing properties of wool can be modified by pretreatment with compounds that either resist or assist dye uptake (Rippon, 2013b; Bell et al., 1984). Blending the treated wool with untreated substrate enables tone-on-tone and multicolour effects to be produced by fabric, yarn or garment dyeing methods (Holt, 1990). Of the compounds investigated, two have been used commercially, Sandospace R and Sandospace DPE. Sandospace R is a 2,4-dichloro-s-triazine derivative of a di-sulfonated aromatic amine (Sandoz, 1971). It reacts with the nucleophilic sites in wool, in

particular basic amino groups, thereby decreasing the cationic character of the fibre. For each amino group removed, two sulfonic groups are introduced, making the wool more anionic and increasing the ionic repulsion of acid dyes. Sandospace DPE is a fibre-reactive quaternary ammonium compound that increases the substantivity of acid dyes on wool (Sandoz, 1987).

8.2.4.4 Fibre damage in processing and dyeing

Wool fibres can be damaged during wet processes such as shrinkproofing, setting and dyeing (Lewis, 1989). This can have an adverse effect on downstream processing, such as increased end-breaks and reduced yields in spinning (Rippon et al., 1995), the performance of end products, for example, abrasion resistance (Feldtman et al., 1983), and cause unacceptable yellowing (Beal et al., 1960).

In hot acidic dyebaths (below pH 3), damage occurs mainly by peptide bond hydrolysis, particularly at aspartic acid residues (Alexander and Hudson, 1963; Baumann, 1979; Lewis, 1989) and tryptophan side chains (Alexander and Hudson, 1963). Above pH 3, in addition to peptide bond hydrolysis, fission of disulfide cross-links becomes increasingly important with increasing liquor pH (Alexander and Hudson, 1963; Baumann, 1979; Lewis, 1989; Asquith, 1979). Under alkaline conditions, for example, in dyeing wool/cotton blends or in setting operations, cystine can also undergo a β -elimination reaction to produce lanthionine and lysinoalanine, as shown in Fig. 8.12. Lanthionine formation is particularly important because it is believed to lead to fibre embrittlement and decreased abrasion resistance (Ponchel and Bauters, 1975).

Boiling dyebaths have been shown to extract nonkeratinous protein material from the endocuticle, the CMC and the intermacrofibrillar regions of wool (Baumann, 1979). Although even lengthy times at the boil extract only a relatively small amount of material, the effect on the physical properties of wool is very pronounced (Baumann, 1979). The presence of electrolytes also affects the amount of material extracted and the level of damage (Baumann, 1979; Lewis, 1989). At pH values above 6.8, sodium sulfate, which is used in wool dyeing, causes a marked decrease in abrasion resistance. As discussed previously, ionic bonds are important in helping to stabilize the structure of wool proteins. As indicated in Fig. 8.2, the number of these bonds in wool varies with pH, and it has been known for many years that fibre damage can be minimized by dyeing wool in the isoelectric region (pH 3.5–4.5), where the concentration of these bonds is at a maximum (Rippon, 2013a). In the isoelectric region, hydrolysis of amide and disulfide bonds is also at a minimum (Rippon, 2013a; Lewis, 1989).

Damage during dyeing can be greatly decreased by dyeing at low temperature (80–90°C). The Sirolan LTD Process, developed by CSIRO, uses a special chemical, based on an amphoteric ethoxylated hydroxy-sulfobetaine structure (Valsol LTA: APS Chemicals) (Rippon and Harrigan, 1994) to modify the fibre surface and the CMC in a simple pretreatment, which increases the rate of exhaustion and diffusion of dyes into the fibre (Rippon, 2013b). Wool dyed by this method has been shown to have better processing performance than conventionally dyed material (Rippon et al., 1995).

Permanent setting occurs when wool is dyed and this can have beneficial effects. For example, when wool is dyed in a relaxed state in hank form, strains in the yarns can be released which results in the yarns being permanently set in a bulky state. In piece dyeing, however, permanent setting produces an increase in hygral expansion (Brady, 1997) and unacceptable surface marks ('crow's feet') (Lewis, 2008). In package dyeing, yarn bulk is decreased because the yarns are set in an extended and thin configuration on the package (Cook and Fleischfresser, 1989).

In addition to the chemical degradation, discussed above, permanent setting during dyeing is also a major factor in decreasing the quality of dyed wool (Lewis, 2008; Cookson et al., 1991), in particular the tensile properties (Huson, 1992). Setting during dyeing can be prevented by addition to the dyebath of an 'anti-setting agent', such as Basolan ASA (BASF) (Cookson et al., 1995). This reagent is a peroxide activator and, when used in conjunction with hydrogen peroxide, enhances the action of the peroxide at low pH in removing thiol groups that are known to increase the rate of thiol/disulfide interchange reactions responsible for wool setting, as shown in Fig. 8.11.

Chlorination treatments have a pronounced effect on wool. In addition to reacting with the cuticle, as discussed previously, chlorination also oxidizes cystine bonds and cleaves protein chains. These reactions can produce a significant weight loss from the fibre, in particular from the CMC (Zahn, 1980), and a decrease in abrasion resistance (Feldtman and Leeder, 1985). Furthermore, the changes produced by chlorination make the fibre susceptible to additional damage on subsequent dyeing. This can further decrease abrasion resistance and, depending on the level of chlorination, can result in very significant weight losses (Byrne et al., 1995b).

8.2.5 Improving the abrasion resistance of wool

The abrasion resistance of undamaged wool can be increased by various treatments. These include extraction of lipids from the CMC with various solvents (Leeder, 1986; Feldtman and Leeder, 1984; Rippon and Leeder, 1986; Feldtman et al., 1983; Feldtman and Leeder, 1985; Leeder and Rippon, 1983). It has been suggested that the lipids in the CMC bilayers are responsible for the mechanical weakness of the CMC and that their removal results in increased intercellular adhesion and, hence, increased resistance to torsional fatigue (Leeder and Rippon, 1983).

Fabric abrasion resistance can also be increased by treatment with low levels of cross-linking agents, such as formaldehyde (Feldtman et al., 1983). It is believed that increasing the cross-link density of the CMC makes this region more resistant to fracture when subjected to torsional fatigue (Feldtman et al., 1983; Feldtman and Leeder, 1985). Treatment with high levels of cross-linking agents, however, decreases abrasion resistance, presumably because of embrittlement of the fibres (Feldtman et al., 1983).

8.2.6 Wrinkling and wrinkle recovery

Prior to the development of polyester, wool fabrics had better wrinkle recovery properties than those made from other textile fibres. The wrinkle recovery of wool is largely

determined by the viscoelastic properties of the fibres with a small contribution from fabric structure (Denby, 1980). As discussed in Section 8.2.1 wool is composed of intermediate filaments embedded in a matrix. The intermediate filaments are composed of crystalline, highly elastic, α -helical peptides, which are virtually unaffected by the sorption of water. The matrix, however, has a relatively disordered, more viscous structure consisting of high-sulfur proteins. It is relatively easily plasticized by moisture, which increases the rate of stress relaxation when a fabric is deformed, for example during wear or storage. Whereas the elastic component of wool deforms and recovers very quickly, the more viscous matrix lags behind the crystalline regions, both in the rate of deformation and also in the rate of recovery when the deforming force is no longer present.

As with all polymers, an important property in determining the stress relaxation behaviour of wool is the glass transition temperature (T_g). For dry wool the T_g is around 170–175°C (Wortmann et al., 1984; Rippon et al., 2016). Increasing the relative humidity (RH) increases the regain (moisture content) of wool and this results in a rapid decrease in T_g . Thus at 85% RH, the regain of wool is around 20% and the T_g approximately 30°C (Wortmann et al., 1984). Poor wrinkle recovery is obtained when the fabric is deformed when it is above its T_g and then allowed to recover (relax) when it is below the T_g . Under practical conditions, during garment wear, when a fabric is close to the skin it absorbs perspiration and can reach a regain of 20% or above. This can result in a T_g value of 30°C, which is close to body temperature. Thus, wrinkles are easily inserted under these conditions. When the fabric is no longer in contact with the skin, it loses moisture and the regain decreases towards its value under ambient conditions (15%–16%). This causes the T_g to increase to a temperature around 60°C, which is above that of the environment, before the fabric has time to recover from deformation. This results in the wrinkles remaining in place. This behaviour, however, gives wool the advantage that it enables wrinkles introduced into a garment during wear to be easily removed by hanging a garment in a steamy atmosphere (e.g. a bathroom) for a few hours.

Various treatments have been studied in an attempt to improve the wrinkle recovery of wool. As discussed above, the wrinkle recovery of cotton is much poorer than that of wool, but as discussed in Section 8.5.5 it can be improved by treatments that usually involve cross-linking. Treatments on wool that involve modifying the intermediate filaments usually decrease the WR. As discussed above, the matrix plays an important role in determining the WR of wool; therefore, attempts have been made to produce improvements by modifying this region of the fibre. One approach that has been extensively studied is to incorporate large organic molecules into the matrix, in an attempt to decrease the sorption of water and thus its plasticizing effect at high humidities. These include ninhydrin, benzoquinone and the mothproofing agent, Mitin FF. These compound appear to work by increasing the torsional modulus of the fibre and, hence the WR (Feughelman, 1980). Large concentrations of the compounds are, however, required to produce worthwhile improvements, which affects other properties such as handle and colour. Some metal salts also produce improvements in WR. The most notable of these are mercury

compounds (Jones and Leeder, 1974a). The treatment, however, has no practical value because of the toxicity of mercury and significant discolouration of the fibre.

Treatment with various polymers has been studied extensively. Linear polymers applied from swelling solvents decrease wrinkle recovery (Jones and Leeder, 1974b). Cross-linked polymers, including those used on cotton (see Section 8.5.5), were found to produce only small improvements in WR. This was believed to be due to a decrease in stress-relaxation during deformation of the fabric (Jones and Leeder, 1974b). The small effect of these polymers on the WR of wool contrasts with their effect on cotton where cross-linking produces large improvements in both wet and dry WR (see Section 8.4.5).

The effect of treatment with preformed silicone or polyurethane polymers on the WR of wool has also been investigated. These polymers were developed as shrink-resist agents for wool fabrics (see Section 8.2.2), where they function via the formation of inter-fibre bonds which restrict fibre migration during laundering. When these polymers are applied to fabrics with high inter-fibre friction, such as cotton and nylon, restriction of fibre movement during deformation leads to improved WR (De Boos, 1976). A properly finished wool fabric, however, has very low inter-fibre friction and introduction of inter-fibre bonds by the application of polymers has no effect on WR, unless a very high concentration of polymer is used (Jones, 1973). Such high concentrations are prohibitive because of cost and also an unacceptable change in the handle of the fabric.

8.2.6.1 Ageing and annealing

The WR of wool slowly improves with time when stored under ambient conditions (Rigby and Mitchell, 1972). This phenomenon has been attributed to a process of slow molecular rearrangement at temperatures below the T_g , with the structure moving towards a minimum energy state. The process has been described in terms of a linear viscoelastic model (Chapman, 1974). The improved WR resulting from ageing is, however, fully reversed by increasing the temperature and humidity; for example in steam pressing or wetting. The rate at which the WR of wool increases during ageing can be accelerated by heating a fabric at constant regain, followed by a slow cooling step. This procedure has been termed “annealing” (Taylor, 1973). Annealing at 65–70°C produces some chemical changes in wool; most notably some loss of cystine, which is converted into lanthionine. It has been concluded, however, that chemical changes provide only a minor contribution to the annealed state and that of more importance is the formation of a stable packed state, possibly assisted by formation of new chemical bonds.

The sensitivity of the annealed state to easy reversal by temperature and/or moisture means that annealing treatments have no practical significance. Attempts have, therefore, been made to increase the stability of the improved WR obtained by annealing treatments. Much work was carried out on annealing in the presence of formaldehyde vapour (Delmenico and Wemyss, 1969; Jones et al., 1973). Although small permanent improvements in WR were obtained, this was accompanied by significant losses in abrasion resistance. Other cross-linking agents were found to give similar results to

formaldehyde (Jones et al., 1972). Annealing in the presence of hydrogen sulfide has been claimed to increase the stability of the annealed state (Russell and Pierlot, 1999). The method does not appear to have been used commercially, probably because of the difficulty in handling toxic hydrogen sulfide in a textile mill; and also because of the possible shade change of many dyes when exposed to hydrogen sulfide. When higher WR is required, for example for light weight suiting fabrics, the only practical way to achieve this at present is by blending wool with a high recovery, low friction fibre. Blending wool with around 30% polyester has been widely used for this.

8.2.7 Insect resistance

Wool is a tough material that is resistant to degradation by sunlight and water. It is very slowly degraded into its constituent amino acids by soil organisms with the release of nutrients into the environment. Thus, unlike synthetic fibres, wool is a totally sustainable and renewable material. Wool cannot be digested by most insects because the extensive network of disulfide bonds protects the fibres from attack by the digesting proteolytic enzymes in the insects' guts. However, the larvae of some the common clothes moth, brown house moth and carpet beetle have developed the ability to digest wool and other keratinous materials. This ability is believed to be due to alkaline reducing conditions in the larval midgut that breaks disulfide cross-links within the fibre; this allows the wool to be digested by proteolytic enzymes (Powning and Irzykiewicz, 1962; McPhee, 1971).

Wool products that are stored or left undisturbed for long periods, such as carpets, insulation and heritage garments, are particularly susceptible to attack and protecting such goods is both commercially important and a technological challenge. Protection of wool goods from insect damage is achieved by application of insect-resist (IR) agents, preferably during manufacture. A variety of IR agents have been used for this purpose and these have been recently reviewed (Barton, 2000; Simpson, 2002b; Ingham et al., 2012).

Insect nerve toxins are the most effective IR agents currently used and include the synthetic pyrethroids, such as Permethrin, originally developed for agricultural use (Fig. 8.17). Except for wool insulation, the most convenient means of applying these agents to wool is during dyeing. This eliminates the need for a separate wet processing step and, under ideal conditions in a hot dyebath, the pesticide is absorbed into the

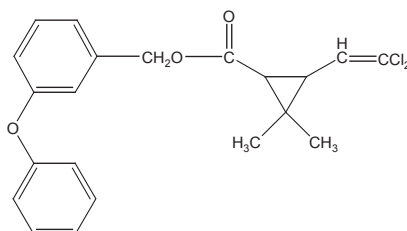

Figure 8.17 Chemical structure of permethrin.

interior of the fibre. This gives good fastness to washing and dry-cleaning. Good penetration of the IR agent into the fibre also minimizes contact with non-target species, because the active chemical is only released after the fibre has been digested. The most commonly used mothproofing agent over the past 30 years, Permethrin, has low cost, low water solubility and low mammalian toxicity. Unfortunately, Permethrin and other commonly used pesticides are toxic to aquatic life. Even under optimal conditions it is impossible to achieve 100% uptake of the pesticide into the fibre. The problem is compounded because some dyes and auxiliary chemicals used in dyeing can suppress the uptake of IR agent by wool (Rippon et al., 1995; Rippon and Harrigan, 1994). The release of IR agents into the environment has caused some ecological concerns about the use of these chemicals. This resulted in the introduction of very stringent conditions on the amount of insecticide allowed in dyehouse effluent, particularly in the United Kingdom. In an attempt to avoid this problem, alternative application techniques for applying IR agents to textile products have been investigated. These include improved fixation to the fibre by means of low liquor application techniques, dry application methods and co-application with polymeric binders. The exhaustion of IR agents can be improved by using the low temperature dyeing auxiliary, Valsol LTA, mentioned previously (Rippon and Harrigan, 1994). This reduces the concentration of IR-agent required in the dyebath (Rippon et al., 1995; Barton, 2000). The Lanaguard process, developed by Ag Research of New Zealand, is a dry powder process in which a powder containing Permethrin and a polymeric carrier is sprinkled onto the carpet pile prior to baking in an oven. The polymer carrier melts and the insect-resist agent diffuses onto the fibre surface (Barton, 2000). In a similar approach, Permethrin has been co-applied with a polyurethane binder in a pad/dry/cure application. This gives a high level of insect resistance to wool products even after extensive laundering, with the added benefit of minimal concentrations of IR-agent in the effluent (Cleyman, 2010). Alternative IR agents, based on insect growth regulators that have lower ecotoxicological properties than conventional IR agents, have recently been marketed (Barton, 2000). In addition to toxicity to aquatic species, another major problem for Permethrin and similar IR agents is the development of resistance to the target species. In an attempt to overcome this issue an alternative synthetic pyrethroid (Bifenthrin) has been introduced as a replacement for Permethrin (Barton, 2000). Bifenthrin has a lower toxicity to aquatic life than Permethrin. It also has better washfastness, is more effective at lower concentrations and, currently, has no problem of resistance to carpet beetles. Alternatives to Pyrethroids have been investigated and, in 2007, Chlorfenapyr was introduced (Mills, 2007). Currently, immunity of moths and beetles to IR agents is confined to the Pyrethroid class of compounds, particularly Permethrin. It is expected, therefore, that resistance to a non-pyrethroid, such as Chlorfenapyr, will not develop in the near future. Another benefit of Chlorfenapyr is its lower toxicity to aquatic life compared with either Permethrin or Bifenthrin (Ingham et al., 2012). Other possible alternative IR agents are being investigated. One that has shown promise is a surfactant that is currently used as a dye levelling agent (Ecolan CEA: Chemcolour NZ). This compound is claimed to provide good protection against insects plus excellent fastness properties (Ingham et al., 2012)

8.2.8 Bleaching

The colour of wool can vary from a light cream to almost black, and in order to produce products in light shades it is essential to bleach the natural chromophores in the fibre. The chromophores can arise through endogenous or exogenous factors. Examples of the former include pigments produced by irradiation, heat or chemical treatment, while the latter include environmental factors such as bacterial, fungal and urine staining (Duffield and Lewis, 1985). Many of the chromophores are readily removed by scouring but some discolourations, such as ‘canary’ yellowness and urine staining, are either not removed or only partially scourable (Duffield and Lewis, 1985). These wools are usually bleached, either for specific colour requirements or to increase the value of the wool.

Commercial bleaching may be carried out by an oxidative or reductive process. In order to obtain the whitest wool, a double bleaching operation is used in which the material is treated sequentially by both processes (Lewis, 2013a). Oxidative bleaching is based on the use of peracid salts (sodium perborate, persulfate) or hydrogen peroxide, under alkaline conditions. Under such conditions, the active bleaching species is believed to be the perhydroxy anion (OOH^-), the formation of which is encouraged by higher pH. Stabilizers, such as sodium silicate, are commonly used to control peroxide decomposition and bath pH. Sequestering agents are also added to remove traces of metal ions, such as copper, that would otherwise catalyze peroxide oxidation of the wool, resulting in significant fibre damage.

Reductive bleaching of wool is carried out under neutral or slightly acidic conditions, using precursors of sulfur dioxide or sulfinic acid derivatives, such as sodium hydrosulfite ($\text{Na}_2\text{S}_2\text{O}_4$) (Duffield and Lewis, 1985). Even with the best bleaching processes, however, there is a limit to the whiteness that can be achieved with minimal fibre damage. For this reason, a double bleaching operation, in which an oxidative bleaching is followed by a reductive bleaching, is often used.

To enhance the whiteness further, wool is often treated after oxidative bleaching with a fluorescent whitening agent (FWA). When reductive bleaching is used, the FWA can be added to the bleaching bath. The FWA-treated wool absorbs ultraviolet (UV) light and emits blue fluorescence, making the fabric appear much whiter than bleached wool. Commercial FWAs suitable for wool are based on sulfonated stilbenes, distyrylbiphenols or pyrazolone derivatives (Fig. 8.18). They are generally applied from an acidic bath at application levels not exceeding 0.25% omf. One major disadvantage of these treatments, however, is that FWAs yellow rapidly when exposed to sunlight, especially when wet (Millington, 2006a).

8.2.9 Treatments to reduce yellowing

Wool is more susceptible to radiation than most other fibres. It is either photobleached with visible light at wavelengths above 398 nm, or yellows when exposed to UV radiation at wavelengths below 331 nm. Under natural sunlight, yellowing predominates and is accompanied by a loss of fibre strength (phototendering). Millington has recently summarized the extensive research into the photoyellowing of wool and

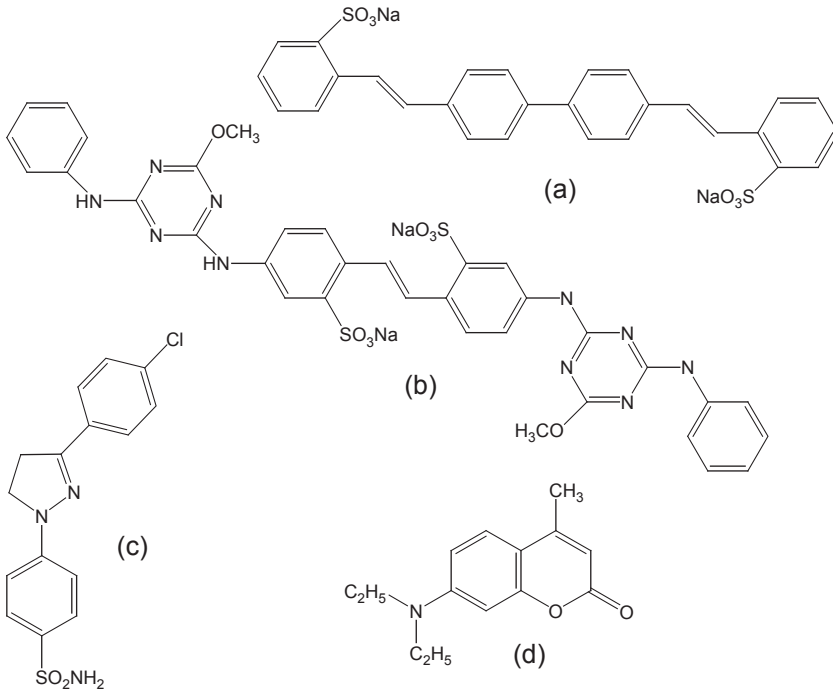

Figure 8.18 Chemical structure of common FWAs. (a) Uvitex NFW (distyrylbiaryl), (b) Uvitex CF (stilbene), (c) Blankophor DCB (pyrazoline) and (d) 7-diethylamino-4-methylcoumarin.

also methods of prevention (Millington, 2006a). Several possible mechanisms are probably responsible for the yellowing of wool, with the most likely involving the generation of reactive oxygen species (predominantly hydroxyl and superoxide radicals). In the presence of trace metal ions within the fibre, these catalyze the formation of yellow chromophores (Millington and Kirschenbaum, 2002; Millington, 2006b).

To date, there is only one commercial treatment for improving the photostability of wool. This is mainly used to reduce phototendering rather than photoyellowing. This treatment, developed by CSIRO, involves application of a UV absorber, based on 2-hydroxyphenyl benzotriazole (Fig. 8.19). This anionic, water-soluble compound behaves as a colourless dye and can be applied under acidic conditions during the dyeing process. At application levels of 3% omf, it can provide up to three-fold lifetime

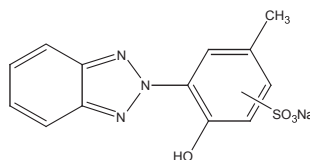

Figure 8.19 Chemical structure of sulfonated 2-hydroxyphenyl benzotriazole (Cibafast W).

improvement on exposure to intense light. This treatment is used for automotive fabrics, where stringent high-temperature light fastness is critical. It cannot, however, be used on FWA-treated wool as it absorbs the wavelengths necessary to excite the FWA.

A number of other treatments to prevent photoyellowing have been tested. These include a precondensate of thiourea and formaldehyde and various reducing agents and oxygen scavengers including bisulfite, thioglycollic acid, *N*-acetylcysteine and *tetrakis*-hydroxymethylphosphonium chloride. The improvements obtained, however, are small and are lost after laundering. A promising recent development (Millington, 2006b) employs a combination of an antioxidant, such as L-ascorbic acid or *N*-acetylcysteine, with a metal chelator. This treatment is highly effective against the photoyellowing of wool, particularly under wet conditions. Although the effect of the treatment is not stable to laundering, this study highlights the role of metal ions in the formation of oxygen free radicals and the value of metal chelators in inhibiting their influence on photoyellowing.

As mentioned in Section 8.2.8, discolouration of wool can also occur due to environmental factors, particularly when sheep are stored in sheds for long periods. This can lead to permanent yellowing that is not removed by scouring. The main factors that cause yellowing are ammonia released from bedding, urea, excrement and high humidity (Wojciechowska et al., 1991). The pigments associated with this yellowing occur predominantly in the cuticular regions of the fibre and have been identified as phenazines derivatives associated with *Pseudomonas bacteria* in the fleece (Dyer et al., 2005). Good animal husbandry that reduces the humidity and microbial growth can reduce the incidence of this yellowing (Wojciechowska et al., 1991).

8.2.10 Polymer grafting

The covalent grafting of polymers into wool has been extensively studied with the aim of improving fibre properties and reducing the cost of pure wool products (Maclaren and Milligan, 1981; Simpson, 2002a). A variety of initiation systems have been employed including gamma and UV radiation and chemical means with organic peroxides, mineral acids and redox systems. The majority of studies have been conducted with vinyl monomers such as styrene, acrylates and acrylonitrile where high add-ons with minimal formation of homopolymer in the reaction bath are possible.

Arai and co-workers found that the location of the polymer within the fibre depends on the grafting conditions and may vary from the orthocortex to uniformly distributed across the fibre (Arai, 1973). Both water soluble and insoluble monomers can be used with the most practical application method being conducted in a dyebath where water insoluble monomers can be emulsified with a detergent in a side tank prior to addition.

Many of wool's fundamental properties are changed by the grafting process including basic properties such as stiffness, abrasion and pilling resistance. Sorption of dyes, setting behaviour, felting shrinkage and wrinkle resistance can also be changed although not necessarily for the better. For example, high add-ons of polymer to super fine Merino wools results in considerable swelling which can be detrimental to fibre handle. On the other hand polymer grafting using inexpensive monomers such as butyl acrylate to carpet wool has the advantage of reducing the cost of the fibre

relative to pure wool without compromising processing or final performance of the carpet (Simpson, 1971). However, to date this technology has not been adopted commercially.

8.3 Silk

Silk is a protein fibre produced by a large variety of insects and spiders, although only selected species of silk-producing moths are cultivated commercially (Sutherland et al., 2010). The most important of these is the common silk worm, *Bombyx mori*, but a number of other species of wild moths including Tussah, Eri and Muga, principally grown in China and India, are also important sources of silk (Robson, 1998; Currie, 2001). Silk accounts for less than 0.2% of the world fibre market but enjoys an enviable reputation in the textile trade for its outstanding qualities, including fineness, softness, lustre, drape and brilliance of colour when dyed (Currie, 2001). Despite these positive attributes, however, silk is regarded as a delicate fibre that requires special care. Considerable research has been directed to improving the physical and chemical properties of this fibre, in order to expand the market for silk products and to meet the demands for easy-care garments.

Further information on silk fibres and on the production and future of natural silk manufacture can be found in volume 1, Chapter 13 and volume 2, Chapter 3 respectively of this Handbook.

8.3.1 Chemical and physical structure of silk

The properties, composition and morphology of silk depend on its source and a number of excellent reviews are available (Sutherland et al., 2010; Robson, 1998; Lucas et al., 1958; Rudall, 1962; Lucas and Rudall, 1968; Komatsu, 1979). Of the natural fibres, silk is unique in that it is produced as a continuous filament. As extruded by *Bombyx mori*, silk consists of two proteinaceous filaments (fibroin) glued together by serine-rich proteins, known as sericins (Fig. 8.20). Chemically, fibroin consists of two major proteins: heavy fibroin (>200,000 Da) and light fibroin (25,000–30,000 Da). These are believed to be linked by a disulfide bridge in association with a minor glycoprotein (~25,000 Da) (Tanaka et al., 1999; Inoue et al., 2000).

The amino acid composition of fibroin and sericin from *Bombyx mori* are given in Table 8.2. Fibroin is characterized by a high glycine, alanine and serine content, which account for over 80% of the total amino acid residues. Sericin is rich in serine, glycine and aspartic acid, which together account for over 60% of the total amino acid residues. The high proportion of polar residues in sericin explains the relative ease of its removal by hot dilute soap, alkaline solution or enzyme treatments (Gulrajani, 1992; Nakpathom et al., 2009). Investigation of the structure of silk by X-ray diffraction, infrared and Raman spectroscopy, and protein analysis shows a β -pleated sheet structure with a chain axis parallel to the fibre axis. Packing of multiple β -sheets requires that all the amino acids orientated towards a particular face have similar size and hydrophobic character. The protein sequence that determines these structures is

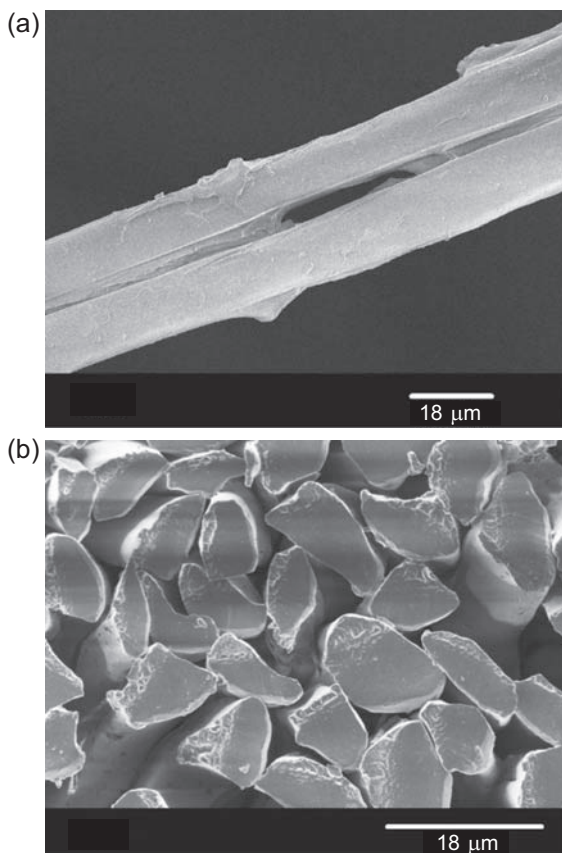

Figure 8.20 Scanning electron micrographs of raw silk: (a) longitudinal and (b) cross-section.

characterized by consecutive Gly-X repeats ($X = \text{Ala}, \text{Ser}$ or Tyr) which form extended β -sheet structures interspersed with amorphous segments (Robson, 1998).

Several chemical treatments to enhance the properties of silk are available. These include treatments to restore the weight lost on removal of sericin, cross-linking and grafting treatments to improve appearance retention of garments, dyeing and printing, bleaching, treatment with handle modifiers and treatments to retard photoyellowing and phototendering.

8.3.2 Weighting

Raw silk contains up to 25% by weight of sericin (Fig. 8.20) that is removed in the degumming process (see Chapter 1). This loss of weight can be offset by various chemical treatments in a process known as ‘weighting’. Treatments include application of tin salts, sugars, gums and waxes, or by the grafting of polymers. Weighting not only increases the weight of a silk fabric but can also improve its handle by giving

Table 8.2 Amino acid composition of silk fibroin and silk sericin from *Bombyx mori* (Mole %).

Amino acid	Fibre (Lucas et al., 1958)	Sericin (Komatsu, 1979)
Glycine	44.6	12.7
Alanine	29.4	5.5
Phenylalanine	0.6	0.4
Valine	2.2	2.7
Leucine	0.5	0.7
Isoleucine	0.7	0.6
Serine	12.1	32.0
Threonine	0.9	8.3
Tyrosine	5.2	3.4
Aspartic acid	1.3	13.8
Glutamic acid	1.0	5.8
Histidine	0.1	1.3
Arginine	0.5	2.9
Lysine	0.3	3.3
Methionine	0.1	0.1
Cysteine	0.2	0.1
Tryptophan	0.1	n.d.
Proline	0.4	0.6

n.d., no data.

body to a fabric that would otherwise be flimsy, particularly after washing and dry cleaning (Currie, 2001). Fabrics intended for printing, however, are rarely weighted because the steaming process necessary for dye fixation can cause excessive fibre damage to weighted silk (Chu and Provost, 1987).

Some silk weavers continue to use degummed, non-weighted silk which is officially known as 'pure silk'. Under European legislation, fabrics woven from weighted silk, without any other fibre being present, may be designated as 'all silk' or 100% silk, because weighting agents, dyes and other auxiliaries are not taken into account (Currie, 2001).

The traditional method used for silk weighting is the tin-phosphate-silicate process. This multi-step procedure involves treatment with stannic chloride for an hour, followed by treatment with disodium hydrogen phosphate at 65°C. It has been proposed that metastannic acid (H_2SnO_3) is formed within the voids of the fibre. This is then hydrolyzed with ammonia to form insoluble tin phosphate ($Sn(OH)_2HPO_4$). The weight gain is approximately 10% and the above steps may be repeated to obtain a

further 10% weight increase (Wolfgang, 1970). X-ray diffraction and transmission electron microscopy (TEM) studies have shown that the tin compounds are located in microvoids within the amorphous regions of the fibroin (Robson, 1998; Kawahara, 1993).

The weighting of silk with tin or other metallic salts is now banned in Japan and is rarely used in India, largely for ecological reasons (Datta and Nanavaty, 2005). Treatments with sugars, waxes and starch have been used to increase the weight of silk goods, although the effect is only temporary and can have a deleterious effect on fabric handle. Other more permanent weighting treatments include treatment with alkaline bentonites fixed with polyamines, tannic or gallic acids, synthetic tanning agents and chemical grafting (Robson, 1998).

8.3.3 Cross-linking and grafting treatments

The wet resilience of silk is relatively poor but can be significantly improved by cross-linking the fibroin proteins. This gives improved wet wrinkle recovery and appearance retention of silk garments, particularly after home laundering. Various cross-linking agents have been investigated, including acid anhydrides, glyoxals, polycarboxylic acids and epoxides. Amino-formaldehyde resins, used for durable-press treatment of cotton (Section 8.5.5), have been used with some success on silk (Yang and Li, 1992). Application of these reagents is generally by a pad/dry/cure process similar to those used with cotton, although they have the disadvantage of releasing formaldehyde into the environment.

A number of bifunctional epoxide cross-linking agents have been investigated to improve the wet wrinkle recovery of silk (Tsukada et al., 1991; Tsukada et al., 1993; Freddi et al., 1996). Treatment with ethylene glycol diglycidyl ether in tetrachloroethylene increases the wet wrinkle recovery from 59% to 79% (Tsukada et al., 1991). In contrast, dry wrinkle recovery is relatively unchanged. Tsukada and coworkers suggested that the mechanism of this improvement involves the formation of a network of cross-links between adjacent fibroin chains by the epoxide that, together with a network of hydrogen bonds, stabilize the fibre structure against mechanical deformation (Tsukada et al., 1993). It was further suggested that this effect is larger in the wet state than the dry state because of the plasticizing effect of the hydrogen-bonded water. The influence of regain on the glass transition temperature of the amorphous regions of fibroin may, however, also be involved (Wortman et al., 1984).

A significant disadvantage of the above cross-linking treatment is the need to use organic solvents to solubilize the epoxide. To overcome this problem, various water-soluble, multifunctional epoxides have been developed (Cheng and Kai, 1998; Cheng et al., 2000; Cai et al., 2001; Cai and Qiu, 2003). For example, application of a non-toxic, water-soluble epoxy silicone (Fig. 8.21) to silk *Habutae* fabric, by a pad/dry/cure process, was found to improve the dry and wet wrinkle recovery by 14%–39%, respectively, without a substantial impact on other physical properties (Cai and Qiu, 2003). Water solubility was conferred by a cationic quaternary ammonium group in the molecule that also served to enhance the uptake of acid dyes.

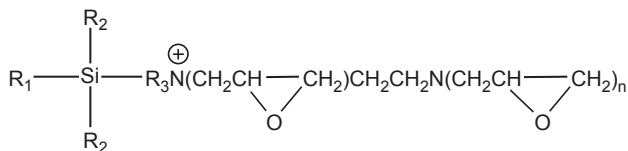

Figure 8.21 Chemical structure of water-soluble epoxide for cross-linking silk (R_1 , R_2 , R_3 are alkyl groups and $n = 1$ or 2).

Other cross-linking reagents that have been examined for improving the wrinkle recovery and stability to washing of silk fabrics include dibasic acid anhydrides, trimethylol melamine (TMM) and polycarboxylic acids. Polycarboxylic acids, such as butane tetracarboxylic acid, that are effective for improving the durable press performance of cotton (Section 8.5.5) are also effective when applied to silk (Yang and Li, 1994). However, the high temperature required during the treatment has a detrimental effect on fabric drape, strength and colour. In more recent research, silk has been cross-linked with specially synthesized bifunctional reactive dyes that give an improvement in wrinkle recovery as well as high dye fixation (Dang et al., 2010).

Chemical treatments, in which polymers are grafted onto silk, have also been used for improving the wet wrinkle recovery and stability to laundering of silk fabrics. Among the reagents used are polyurethanes (Hu and Jin, 2002) and hydroxymethyl acrylamide (Lower, 1988). Methyl methacrylate has been grafted to the silk fibroin inside the fibre by polymerization, using ammonium persulfate as an initiator. Such treatments have the advantage that they restore bulk without having a detrimental effect on the fabric hand. These treatments, however, are more difficult to apply than traditional textile finishing agents.

8.3.4 Bleaching

Degummed silk from *B. mori* varies in colour from off-white to yellow. For pale pastel shades, it is necessary to bleach the silk to produce products with a good, even whiteness. For heavy shades, bleaching is usually not required. Bleaching methods, which are generally similar to those used for wool and other proteinaceous fibres (Section 8.2.8), may be oxidative, reductive or a combination of both. Whichever method is used, careful application is required to avoid excessive fibre damage. Peracid salts and hydrogen peroxide are the most common oxidative bleaching agents. These are used in combination with sodium silicate, as a peroxide stabilizer, plus sequestering agents, such as ethylenediaminetetraacetic acid (EDTA), to chelate metal ions that would otherwise catalyze the action of hydrogen peroxide and result in fibre damage.

8.3.5 Dyeing and printing

Enhancing the properties of silk by colouration is perhaps the most important process in preparing silk goods for the market (Holme, 2010). Colouration may be carried out by yarn or fabric dyeing or by various printing processes. Yarn dyeing is used to produce a range of colour effects that are enhanced by fabric structure.

Piece dyeing of silk fabrics was developed in Lyon in the nineteenth century, using the same dye classes as used for wool (Section 8.2.4). Dye molecules of low molecular weight are readily accessible to the surface amino groups of silk fibroin, which leads to high dye strike rates at low temperatures. Conversely, the high strike rate also means that colour can be readily removed under aqueous conditions, leading to dye bleeding in laundering. For this reason, dry-cleaning is generally recommended for cleaning dyed silk fabrics.

Traditionally, silk was dyed with similar natural dyes to those used on wool (Section 8.2.4) and some speciality products, such as carpets, are still dyed in this way. Most silk is, however, now dyed with acid, metal complex or reactive dyes (Chu and Provost, 1987). Acid and pre-metallized dyes are generally applied with a low temperature dyeing auxiliary and a levelling agent at 70–85°C. Increasing environmental concerns over the past few years have led to a reduction in the number of dyes available for silk and this has resulted in an increase in the use of reactive dyes. The advantages of such dyes are that they are available in a wide range of shades and also have excellent fastness properties, because they form covalent bonds with the silk proteins (Ball et al., 1985; Gulrajani, 1993). The level of fixation depends on the functional group in the dye molecule. For example, Ball found that the fixation of reactive dyes containing vinyl sulfone and monochlorotriazine functional groups was 85%–90%, respectively (Ball et al., 1985). More recent research has examined new methods of dyeing silk using encapsulated acid and reactive dyes (El-Zawahry et al., 2009) and also reactive disperse dyes (Youssef et al., 2009). Reactive dyes have also been used to further enhance the beauty of naturally gold coloured Muga silk (Goel and Rani, 2010).

Silk prints are the most popular of all silk goods and are used for a large range of products, including ties, scarves and dress fabrics. Printing has continued to evolve from block, screen through to digital printing systems. Screen printing can be done with acid, metal-complex and reactive dyes and can involve a large number of colours (Currie, 2001). Spectacular effects can be produced by discharge printing. In this technique, a pre-dyed fabric is overprinted with a mixture of a reducing agent that destroys the ground colour and an 'illuminating' colour that is resistant to the reducing agent, thus adding a new colour to the printed area.

Digital inkjet printing is eminently suitable for silk, because it allows short runs of high fashion goods to be printed quickly at a lower cost than conventional screen printing methods.

8.3.6 Treatment with acid and alkali

The low cystine content of silk (Table 8.2) is believed to account for the higher resistance of silk to alkali, compared to other protein fibres (cf. wool, Section 8.2.3). This resistance is used to produce crêpe effects in blends of silk with cotton. Traditional crêpe fabrics are made from very high twist yarns and have a characteristic crinkled surface and 'grainy' feel. This effect can also be produced chemically with less expensive silk-cotton fabrics by treating with sodium hydroxide at low temperature (Robson, 1998).

The natural handle of silk fabric is often associated with a rustling effect, known as 'scoop'. Careful finishing is required to retain this property in the final fabric. Chemical treatment with dilute organic acids such as lactic, tartaric or citric acids can, however, be used to restore or enhance 'scoop'. A typical scooping treatment would involve steeping the fabric in 2–4 mL/L lactic acid for 5–10 min at room temperature. The use of scooping agents has a long history in the silk industry, but it is important to note that this effect is more than likely imparted by an acid finishing treatment.

8.3.7 Photoyellowing

Silk has poor resistance to UV light and is the most sensitive of the natural fibres to sunlight, which causes photoyellowing followed by phototendering. The latter is characterized by loss of physical and mechanical properties (Turner, 1920). This behaviour is particularly relevant for the storage, display and conservation of silk goods.

It has been proposed that the mechanism of fibroin photo destruction involves free-radical oxidation of the peptide chains of fibroin proteins to form chromophoric α -ketoacids (Meybeck and Meybeck, 1967; Baltova et al., 1998; Baltova and Valcheva, 1998). Millington and Kirschenbaum suggested that the photoyellowing of wool occurs via formation of hydroxyl and superoxide radicals, catalyzed by trace metal ions within the fibre, and it appears likely that a similar mechanism applies to silk (Millington and Kirschenbaum, 2002). The formation of chromophores in silk under the action of UV light is retarded by the presence of a sulfonated hydroxybenzotriazole (Section 8.2.9) and this compound has been used to reduce the phototendering of silk goods (Baltova et al., 1998).

8.3.8 Other protein fibres

This group includes mohair, cashmere, alpaca, lama, camel and many other speciality fibres produced by a large variety of mammals. Compared to the major textile fibres, none are produced in large quantities and many are used in blends for niche markets. Like wool, they belong to the hard α -keratins and have a similar chemical composition characterized by a high cystine content. The chemical reactivities of these fibres are closely parallel to those of wool and, generally, the chemical methods developed to enhance the properties of wool can be applied with good effect to these protein fibres.

Another protein fibre that is potentially important for commercial application is that produced by spiders. Spiders produce a variety of silks that have evolved for different uses. For example, dragline silk, used as a frameline within a web, has the highest tensile strength of any natural fibre. Considerable research has been devoted to characterizing the structure of spider silks (Sutherland et al., 2010) but because of the difficulties in producing substantial quantities of such silk, attention has focused on producing synthetic spider silk proteins through genetic engineering and fibre 'spinning' by

conventional extrusion techniques. However, to date, these techniques have not been able to give fibres that match the superior properties of natural spider silk (Service, 2017).

8.4 Cotton

Cotton accounts for over 40% of the world fibre market, making it the most important of the natural fibres (Wakelyn et al., 2007a; Nevell, 1995; Broadbent, 2001a). Unlike other vegetable fibres, such as flax, hemp, jute and ramie (see Section 8.6), cotton is a seed hair and consists of a single cell composed largely of cellulose. During growth, the cotton hair fibre is almost cylindrical, being closed at one end and open where it is attached to the seed. On removal from the seed, the fibre dries and collapses into a convoluted (twisted) flat ribbon-like structure with a generally kidney shaped cross-section (Fig. 8.22). The chemical treatment of cotton to enhance its properties has a long history and many of these treatments have been applied to other cellulose fibres. The most important processes include mercerization, bleaching, colouration and

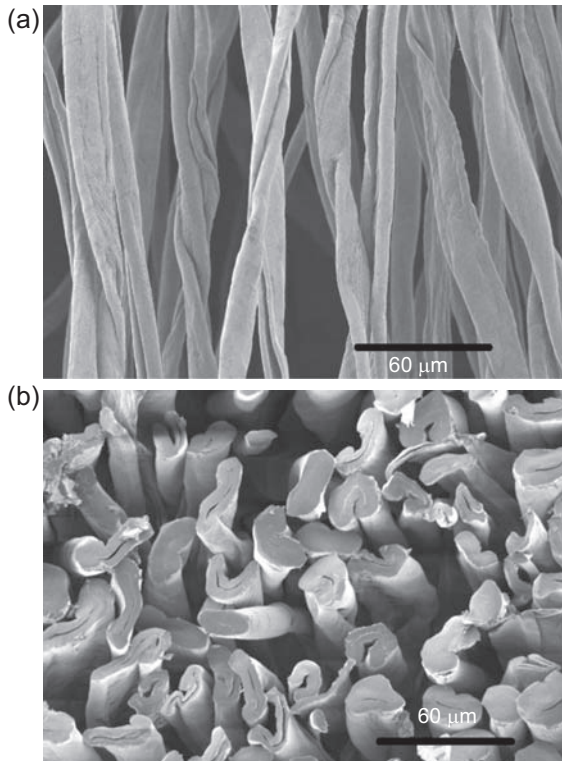

Figure 8.22 Scanning electron micrographs of cotton hairs: (a) longitudinal and (b) cross-section.

cross-linking treatments to improve the durability and appearance retention of cotton goods.

8.4.1 Physical and chemical structure of cotton

Cotton fibres have a complex fibrillar structure. They are composed of a cuticle, or outer cell wall, beneath which lies two layers: the primary wall and the secondary wall. Cotton fibres also contain a lumen, which is a central cavity that is formed following evaporation of the nutrients responsible for cell growth.

The thickness of the secondary wall can vary over a wide range, even in cotton from the same batch. Secondary wall thickness, or maturity, is affected by growing conditions, as these influence the amount of cellulose deposited during the second growth phase. Thin walled, immature fibres are differentiated from mature fibres with fully developed secondary walls by their behaviour when swollen in a concentrated aqueous solution of sodium hydroxide (Lord, 1961). A normal, mature fibre changes to a cylindrical configuration, with an almost absence of convolutions and a filled lumen. As a result of their thinner wall thickness, immature fibres do not swell to the same extent and retain more of their ribbon-like appearance with obvious convolutions and a distinct lumen. Immature fibres have a higher elasticity than fibres with thicker walls and tend to become more easily entangled during mechanical processing to form neps. After dyeing, neps often appear as pale coloured spots in a fabric. This arises because, even though they contain the same concentration of dye, the fibres with thinner walls have different optical properties compared with thicker-walled fibres (Rippon, 1984).

Cotton contains around 95% pure cellulose, with the balance made up of proteins, oils, waxes, carbohydrates, pectins and inorganic materials (Nevell, 1995). The non-cellulosic components of raw cotton are removed by scouring at high temperature with sodium hydroxide solution, usually assisted by a surfactant. This procedure produces a weight loss of up to 7% (Broadbent, 2001a). Even after the non-cellulosic materials have been removed by scouring, cotton is a pale yellow colour. Where white goods or pastel shades are required, the cotton is bleached.

The cellulose component of cotton fibres is a carbohydrate polymer composed of β -D-glucopyranose units, with 1,4-glycosidic bonds (Fig. 8.23) (Nevell and Zeronian, 1985; Kennedy and White, 1988). Cotton fibres have a weight averaged degree of polymerization of around 15,000, with the secondary wall containing higher molecular weight material than the primary wall (Wakelyn et al., 2007a). Treatments with alkali or oxidizing agents can, however, reduce this to as low as 1000–2000 (Nevell, 1995). Cotton fibres have a composite structure of highly crystalline fibrils, between which is less ordered, more amorphous material (Nevell, 1995). Various crystalline structures have been identified in cotton. These have been termed Cellulose I, II, III, IV and V (Wakelyn et al., 2007a; French, 1985). Cellulose I is the native structure, whereas the other crystalline forms are produced by treatment with various chemicals. Industrially, the most important of these is Cellulose II, which is produced by treatment with sodium hydroxide (see Section 8.5.3). Further information on cotton is given in Chapter 1, Volume 2 of this handbook.

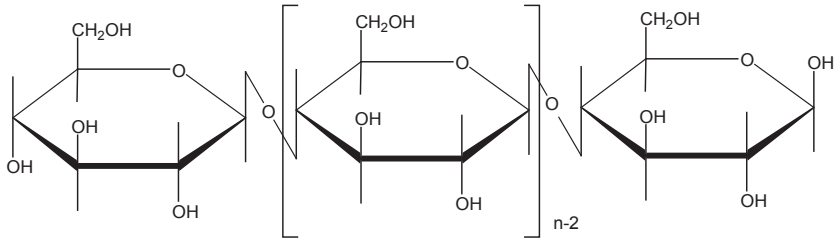

Figure 8.23 Molecular structure of cellulose (n = degree of polymerization).

8.4.2 Scouring and bleaching

As discussed above, raw cotton contains approximately 5% of non-cellulosic material. In addition, cotton fabrics contain processing agents (sizes) applied to warp yarns to prevent breakage during weaving. Sizes are based on various starches, or water-soluble polymers, such as polyvinyl alcohol. It is necessary to remove all these materials before dyeing, in order to avoid adverse effects on the quality of the dyed material (Hickman, 1995). A typical preparation procedure for a cotton fabric involves the following steps.

8.4.2.1 Singeing, de-sizing, scouring and bleaching

In some cases, the fabrics may also be mercerized. Singeing makes the fabric smoother by burning off the short surface hairs raised during weaving. Where a starch-based size is used, de-sizing is carried out by digesting the starch with an enzyme. The traditional method of scouring cotton was by boiling under pressure in an enclosed vessel, called a kier (Garrett, 1964). In this process, the scouring liquor contains sodium hydroxide (ca.2%) and a detergent to help emulsify the cotton wax. In kier boiling, it is essential to exclude oxygen during both the boiling and cooling phases, otherwise under the alkaline conditions used the cotton is degraded by oxidation. Continuous scouring treatments are also now commonly used. In these, the fabric is impregnated with sodium hydroxide solution and then steamed in a sealed pressurized chamber, from which air is excluded. Following either batch or continuous scouring, it is important for the cotton to be thoroughly rinsed in hot water, to remove all the soluble and emulsified impurities.

After scouring, cotton is a pale yellow colour, which is eliminated by bleaching (Broadbent, 2001a; Hickman, 1995). Usually, only white goods and products dyed to pale shades are bleached. Bleaching methods can be either batch or continuous processes. In the past, cotton was bleached with an alkaline solution of either sodium hypochlorite or sodium chlorite, but these chemicals have now been largely replaced by hydrogen peroxide. Under conditions of high temperatures and high pH, decomposition of the peroxide liquors can occur, resulting in cellulose degradation. This is catalyzed by metal ions. These undesirable side effects are prevented by addition of a stabilizer, which sequesters any metal impurities. Sodium silicate, which was traditionally used for this purpose, is both inexpensive and very effective, but it can cause

problems associated with insoluble silicate deposits on the substrate and the machinery. This has led to the introduction of alternatives, based on mixtures of organic materials (Hickman, 1995).

8.4.3 Mercerization

Treatment with sodium hydroxide (mercerization) is perhaps the most important commercial process used for modifying the properties of cotton (Freytag and Donzé, 1983; Zeronian, 1985). In particular, the treatment changes dye substantivity, lustre, smoothness, chemical reactivity, dimensional stability and tensile strength (Abrahams, 1994). Other changes obtained by mercerization include increased moisture uptake and an improvement in the overall uniformity of the substrate (Peters, 1967).

The original patent granted to John Mercer in 1851 (Marsh, 1941) describes a method of changing the properties of cotton fabric, yarn or fibres by treatment with a concentrated solution (32% w/v) of an alkali metal hydroxide, usually sodium hydroxide (caustic soda). Following removal of the alkali, by rinsing with water and neutralization with acid, the effects of the treatment on the properties of cotton were found to be permanent to subsequent wet finishing. The contorted and flattened tape-like cross-sections of raw cotton were converted into smoother, less convoluted fibre shapes having more elliptical cross-sections. There was also an increase in strength and a large increase in the substantivity of dyestuffs. Mercer regarded the latter as the major benefit of his invention. The disadvantage of the treatment was a contraction in fibre length of up to 18%, which was accompanied by an increase in fibre diameter. With an already short fibre, the decrease in fibre length limited the commercial success of Mercer's process, which is now called either causticization, mercerization without tension, or (more commonly) slack mercerization.

In 1889, Lowe discovered that preventing fibre shrinkage during both the caustic soda treatment and the rinsing/neutralization steps produced fibres with substantially round cross-sections, as shown in Fig. 8.24 (Marsh, 1941). There was an increase in the substantivity of dyes and an increase in fibre strength. Unlike Mercer's method, however, preventing shrinkage during the treatment produced a high degree of fibre lustre. Lowe's discovery improved the usefulness of Mercer's causticization process and turned it into the true mercerization process, carried out under tension, as we know it today.

Slack mercerization is carried out in cases where lustre is not important. This procedure, in which the cotton is allowed to shrink, is used to improve dyeing properties and in the production of products where elasticity is required.

The visible effect of caustic soda on cotton fibres varies with the concentration of the reagent (Peters, 1967). Concentrations up to 7% (w/v) do not produce any discernible swelling, but cause the convolutions to disappear and the fibre cross-sections to become elliptical. As the concentration is increased, progressive swelling occurs and at around 11% the lumen is completely filled. At a concentration of 14% and above, the outward swelling is at a maximum, with the primary wall fully extended.

The high affinity of caustic soda for cellulose enables it to penetrate both the crystalline and amorphous regions of cotton. The inter-chain interactions are weakened and

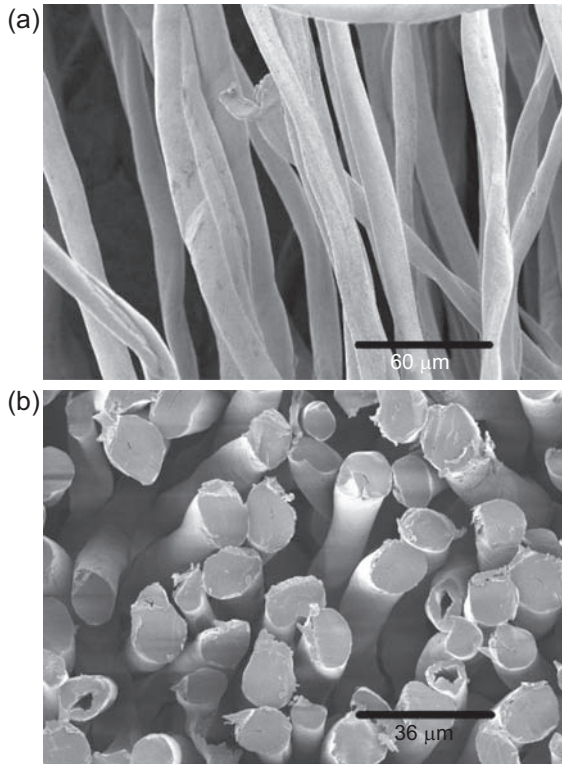

Figure 8.24 Scanning electron micrographs of cotton yarn after mercerization: (a) longitudinal and (b) cross-section.

the strength of the fibres is decreased. The strength recovers when the fibres are rinsed and dried. The irreversible changes in the fine structure of cotton produced by mercerization include partial conversion of the crystal lattice from cellulose I to cellulose II. This is accompanied by a decrease in crystallinity with a reduction in the length of the crystallites (Zeronian, 1985).

The improvement in lustre of mercerized cotton is primarily due to increased specular reflection, resulting from changes in the outside shape of the fibre from a flat ribbon to a more circular configuration. The degree of lustre increases as the ratio of the minor to the major axis of the fibre cross-section approaches unity (Marsh, 1941). The effect of mercerization in increasing moisture uptake results from the decrease in crystallinity of the fibre. The change in crystallinity is also responsible for the improved dye uptake because it produces an increase in the accessibility of dye sites within the fibre (Nevell, 1995). A second effect of mercerization is that, even for the same amount of dye, mercerized cotton appears darker. The magnitude of this effect varies with the depth of shade, but can be as high as 60% compared with untreated material (Greenwood, 1987). The increase in the depth of shade of mercerized cotton results from the changed fibre shape, which affects the internal scattering of light (Goldfinger, 1977).

Mercerization under tension is usually carried out, with an alkali concentration in the range 20%–30% (w/v), on yarns or fabrics, because these substrates can be mechanically constrained to prevent shrinkage during the treatment (Peters, 1967; Marsh, 1941). Mercerization may be carried out either before or after scouring and bleaching. It is, however, usual to de-size cotton fabric before treatment. Mercerization of cotton yarn or fabric may result in an uneven treatment. This is due to incomplete penetration of the highly viscous solution of concentrated aqueous sodium hydroxide, particularly into tightly woven fabrics and into the centre of high twist yarns. The problem is exacerbated by the very high level of swelling of cotton in the alkali, which closes up the structure of fabrics and yarns and impedes penetration of the reagent. Recently, a method has been described for mercerizing cotton slivers under tension (Arnold and Rippon, 2010). This method, which avoids the problems caused by yarn and fabric geometry, has been found to give a very even treatment between the fibres in a sliver.

8.4.4 Treatment with liquid ammonia

Liquid ammonia is also used commercially for improving the properties of cotton, in a fashion similar to mercerization. An advantage of this reagent over sodium hydroxide is that it is easier to remove from the substrate (Calamari et al., 1971). The small molecular size of ammonia facilitates easy penetration into cotton, where it reacts with the hydroxyl groups to form a cellulose–ammonia complex that is stabilized by hydrogen bonds. Depending on the conditions used for removal of the ammonia, the complex decomposes to give different crystalline forms of cellulose. This can result in different changes to yarn and fabric properties (Lewin and Roldan, 1971). Evaporation of the ammonia breaks the complex with the formation of Cellulose III, whereas removing the ammonia by washing with water results in reversion to Cellulose I. Treatment with liquid ammonia gives some of the changes in properties produced by mercerization with caustic soda. There are, however, some differences in the level of the improvements, depending on whether the cellulose–ammonia complex is broken by drying or by washing in water. Both methods of complex destruction give improvements in tensile strength and luster (Calamari et al., 1971). Some improvements in dyeing properties are obtained, provided the complex is broken by aqueous washing (Heap, 1978). Removing the ammonia by evaporation, however, gives better results with respect to fabric smooth drying properties and abrasion resistance, following subsequent cross-linking treatments (Gogek et al., 1969).

The differences in the level of improvements in properties between fabrics mercerized with sodium hydroxide and those treated with liquid ammonia have been explained in terms of differences in the pores, or voids, in the fibrillar structure (Rowland et al., 1984). Large pores are produced by aqueous caustic soda treatment, which gives improved dye uptake. Liquid ammonia treatment, however, produces a relatively large number of small pores. This gives more lateral association of fibrils and explains the better fabric resilience compared with that obtained by treatment with caustic soda.

8.4.5 Cross-linking for durable press finishes

Cotton is a porous, hydrophilic fibre that readily absorbs water. Under ambient conditions it has a regain (amount of water as a percentage of the dry mass) of between 7% and 11%. For cotton apparel, this property helps to control the microclimate next to the skin and accounts for the comfort of cotton textiles. The absorption of moisture causes cotton to swell, which is facilitated by the movement of cellulose chains within the amorphous regions of the fibre. Hydrogen bonds between the cellulose chains are disrupted and, if the fabric is deformed, stress relaxation will occur and the bonds will reform with the structure in a new conformation. This can result in the shrinkage or wrinkling of fabrics.

The swelling of cotton by moisture can be reduced by cross-linking, to give a fabric with improved dimensional stability, wrinkle recovery and crease retention. In principle, any bifunctional reagent that can react with hydroxyl groups can be used to cross-link the cellulose chains. The simplest such reagent is formaldehyde, which reacts with the hydroxyl groups of cotton to give a stable ether linkage, as shown in Fig. 8.25.

Formaldehyde itself has not been extensively used for cross-linking cotton and, in practice, formaldehyde condensation products are preferred (Wakelyn et al., 2007b). Early examples include *N,N'*-dimethylol urea (DMU) and trimethylol melamine (TMM). These are produced by condensation of formaldehyde with urea or melamine, respectively (Fig. 8.26). Of these, the melamine-formaldehyde products are preferred because of their higher stability to hydrolysis and improved durability to laundering (Schindler and Hauser, 2004). These products contain two or more reactive methylol groups that react with cellulose hydroxyls. They can also self cross-link inside the fibre to produce a three-dimensional resin structure that imparts a firm handle to the treated goods.

The most common durable press cross-linking agents currently used for cotton are derivatives of 1,3-dimethylol-4,5-dihydroxyethyleneurea (DMDHEU). These reagents



Figure 8.25 Cross-linking of cotton with formaldehyde.

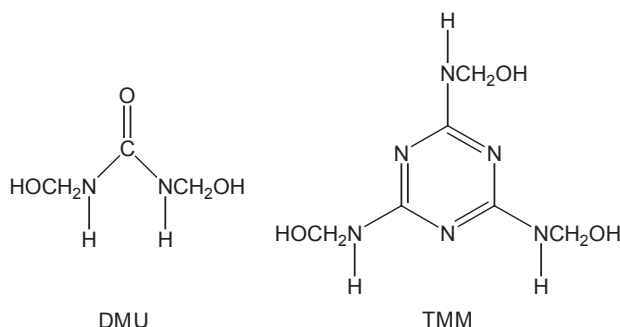

Figure 8.26 Chemical structure of formaldehyde condensation products, *N,N'* dimethylol urea (DMU) and trimethylol melamine (TMM) for cross-linking cotton.

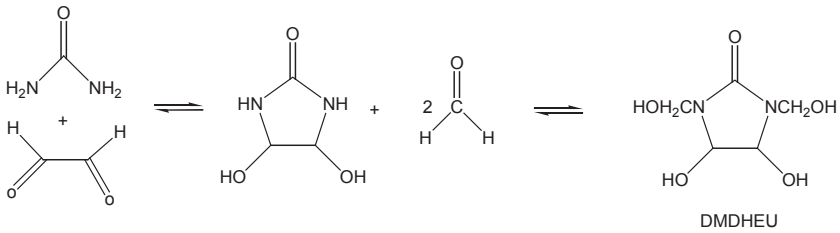

Figure 8.27 Preparation of DMDHEU.

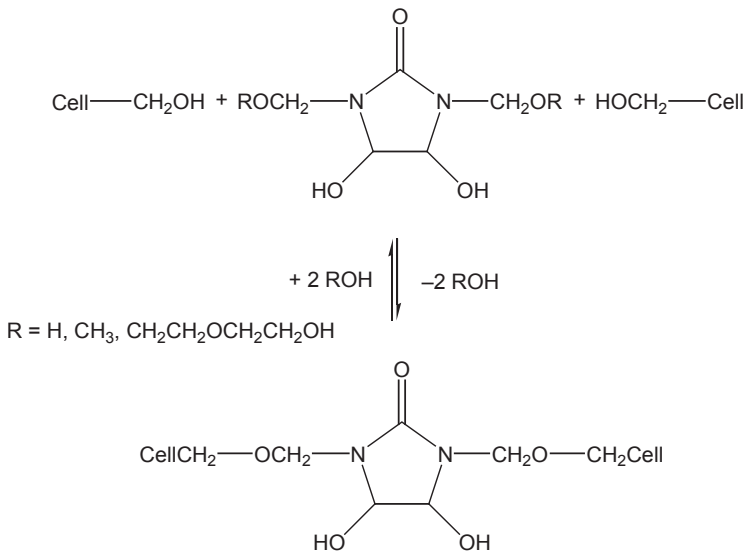

Figure 8.28 Cross-linking of cotton with DMDHEU derivatives.

are prepared by reaction of urea with glyoxal to form a dihydroxyethylene urea intermediate, followed by reaction with formaldehyde to give DMDHEU (Fig. 8.27). DMDHEU derivatives make up about 90% of the easy-care and durable press finish products for cotton and other cellulosic goods on the market (Schindler and Hauser, 2004). DMDHEU has two reactive *N*-methylol groups that, in the presence of an acid (or Lewis acid) catalyst, rapidly react with cellulose hydroxyl groups at high temperature (150–170°C), as shown in Fig. 8.28. Typical acid catalysts used industrially are Lewis acid salts, such as magnesium chloride and zinc nitrate. These are preferred over mineral acids because they give a neutral treatment pH, which results in less acid degradation of the fibre during the high temperature curing step. The proposed mechanism of the acid-catalyzed cross-linking reaction with DMDHEU is shown in Fig. 8.29. Protonation of the methylol oxygen, followed by loss of water, gives the carbonium ion (I), which is stabilized through resonance with the immonium ion (II). The carbonium ion may then react with a cellulosic hydroxyl or another methylol group to

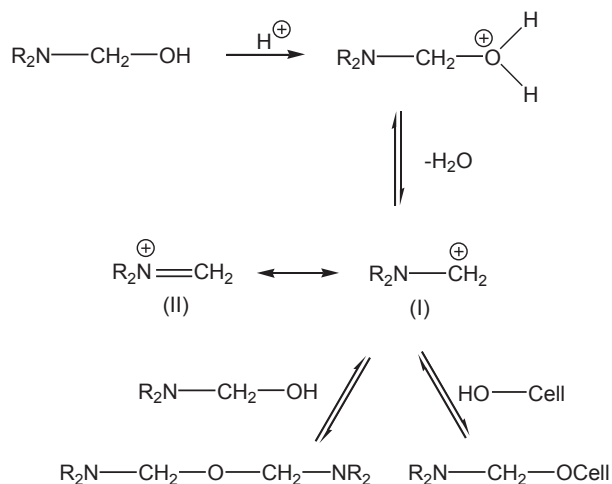

Figure 8.29 Proposed mechanism of acid-catalyzed cross-linking of cellulose by *N*-methylol derivatives.

(Schindler and Hauser, 2004). Source: Adapted from Ref. 225.

give a cross-linked cellulose-bound resin. When wrinkle resistance is required, DMDHEU is usually applied by a pad-dry-cure procedure. When creases or pleats are required in garments, however, the curing step may be delayed until after the garments are made up.

The reversibility of the reactions used for the preparation of formaldehyde condensation products, and their subsequent reaction with cotton, can lead to small concentrations of free formaldehyde in treated goods. Health concern over the release of formaldehyde from urea-formaldehyde and melamine-formaldehyde resins has stimulated research into the development of formaldehyde-free cross-linking agents. Reagents examined to date include derivatives of polycarboxylic acids, di-epoxides, vinyl sulfone derivatives and polyhalides (Wakelyn et al., 2007b). The polycarboxylic acid, 1,2,3,4-butane tetracarboxylic acid (BTCA) is currently used commercially in a pad-dry-cure process, using a weak base or sodium salts of phosphoric or phosphorous acids as catalysts. This treatment is, however, more expensive than those using DMDHEU (Shank, 2002). The mechanism of cross-linking with polycarboxylic acid involves formation of a cyclic acid anhydride, followed by base catalyzed reaction with the cellulosic hydroxyl groups to give an ester cross-link (Fig. 8.30). Catalysts commonly employed with BTCA include sodium hypophosphite or sodium phosphate. A disadvantage of some of the treatments involving polycarboxylic acids is that yellowing of white fabrics can occur (Welch and Peters, 1997). Furthermore, because the catalysts are also reducing agents, they can cause a shade change of some reactive and sulfur dyes that are commonly used on cotton (Schindler and Hauser, 2004).

A disadvantage of many cotton cross-linking treatments is a loss in tensile strength and abrasion resistance as a result of a decrease in the degree of polymerization of the

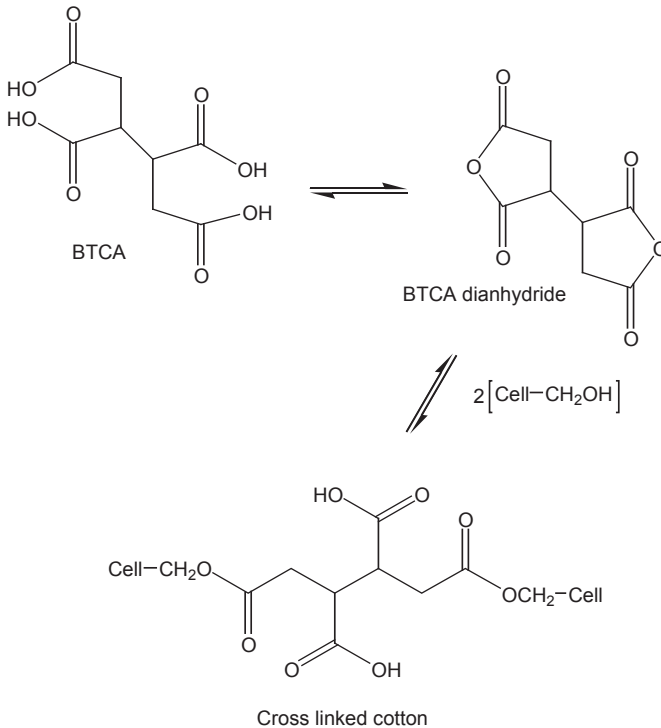

Figure 8.30 Cross-linking of cotton with 1,2,3,4-BTCA.

cellulose chains. Careful preparation of fabrics to remove residual chemicals and rigorous control of treatment conditions is required to minimize this shortcoming (Schindler and Hauser, 2004). As discussed above, the decrease in strength and abrasion resistance may be reduced if the cotton substrates are mercerized, or treated with liquid ammonia prior to cross-linking.

The esterification of cotton with BTCA and other polycarboxylic acids is also effective for improving the flame resistance of carpets and other cotton textiles. Increased char formation on ignition is believed to be responsible for this effect (Blanchard and Graves, 2002; Rearick et al., 2002) (See Chapter 2 for flame resistance treatments of natural fibres).

8.4.6 Corona treatment

Treatment of cotton fibres with a corona discharge has been shown to modify the fibre surface, resulting in an increase in inter-fibre friction, spinning efficiency, yarn strength and abrasion resistance (Thorsen, 1971; Abbott and Robinson, 1977). Fabrics were harsher as a result of the corona treatment, but fabric strength was unchanged (Abbott and Robinson, 1977).

More recently, the effect of plasma treatment on the properties of cotton has been investigated. Changes in properties such as wicking and dyeability have been reported (Bhat et al., 2011).

8.4.7 Dyeing

Cotton is dyed at various stages of manufacture, from loose fibre to fabric. Unlike wool, very little colouration is carried out prior to spinning and the majority of cotton products are dyed in fabric form. Fabric printing with dyes or pigments is also a very important method of fabric colouration. Unlike wool, cotton does not require a pre-treatment prior to printing.

The traditional method of dyeing cotton, involving exhaustion of dyestuffs from long liquor, is still used in several forms today (King, 2007; Broadbent, 2001b). In yarn dyeing, the dye liquor is circulated through packages made by winding the yarn onto perforated centres. Fabric wound onto a perforated shaft is also dyed in a similar manner, in a beam dyeing machine. The other important method of dyeing cotton fabric is in a winch or jig machine. In these, in contrast to the package dyeing machine, circulation is achieved by moving the fabric through the liquor. The two types of machines differ in that the jig keeps the fabric 'open width', whereas in the winch it is circulated in the form of a rope. A variant of the winch, which has become very important since its development in the 1960s, is the jet dyeing machine. In this, the rope of fabric is transported around the vessel by a stream of dye liquor that is pumped through a venturi nozzle. After passing through the nozzle, the fabric falls to the rear of the machine from where it is slowly moved to the front to commence the next circulation. The liquor ratio used in these machines ranges from around 20:1 for winch dyeing to 1:1 for jig machines.

8.4.7.1 Dyeing cotton with natural dyes

As discussed in Section 8.2.4, before the introduction of synthetic dyes, all natural fibres were dyed with colouring materials extracted from plants and animals. Most of these require the use of a mordant, such as a metal salt. As is the case for the protein fibres, most cotton is, however, now dyed with synthetic dyes. These offer clear advantages in terms of a shade palette with high levels of fastness properties that cannot be matched with natural dyes. The situation for cotton differs from that of the protein fibres in that one dye, originally obtained from the leaves of the indigo plant, is still widely used in the manufacture of denim fabrics. An advantage of indigo (a vat dye) over many other natural dyes is that a mordant is not required. Although better than many other natural dyes, the fastness to laundering and rubbing of indigo-dyed denim fabrics are relatively poor compared with fabrics dyed with synthetic dyes. Rather than being a disadvantage, however, this is regarded as one of the attractions of denim, as the worn-look of the garment is consistent with today's casual lifestyle. Until the end of the 19th century, indigo was obtained entirely from several plant sources. Some naturally derived indigo is still produced in India, where 1 tonne is produced from 77 ha of land (Glover and Pierce, 1993). In 1995 the world consumption of

indigo was 22,000 tonnes which would require 1.7 M ha of land (Wick, 1995). Since the early twentieth century, most of the indigo used has been produced by a synthetic route.

Another approach to producing coloured cotton products without using synthetic dyes is from naturally coloured cottons. These are believed to have originated in Peru around 5000 years ago (Vreeland, 1999). Colours, which are due to pigments located in various regions of the fibre, include red, pink, blue green and several shades of brown and tan (Dickerson et al., 1999). Fastness to laundering varies, with some colours fading and some becoming darker. Except for green coloured cotton, light fastness is generally acceptable (Dickerson et al., 1999). A disadvantage of coloured cottons is that they have a shorter staple length and produce lower yields than conventional varieties.

8.4.7.2 Dyeing cotton with synthetic dyes

The synthetic dyes used in the colouration of cotton can be divided into three broad types: direct dyes, reactive dyes and dyes that are formed inside the fibres by the reaction of soluble, usually colourless precursors. The various classes of dye are applied by different procedures.

8.4.7.3 Direct dyes

Direct dyes derive their name because they can be applied ‘directly’ to cotton, without the need for pretreatment with a mordant. The majority of direct dyes are polyazo compounds, with some structures based on anthraquinones and metal-complex compounds (King, 2007; Broadbent, 2001c). They contain sulfonic acid groups, which makes them water-soluble. The acid dyes used on wool are also sulfonated aromatic compounds and some will dye both types of fibres (Peters, 1975). Many acid dyes that exhaust very well onto wool, however, show no substantivity whatsoever for cotton (Giles, 1975). This indicates that there is a difference in the mechanism of substantivity of dyes for cotton and wool. The net positive charge carried by wool under acid conditions plays an important role in the exhaustion of anionic dyes. Unlike protein fibres, cotton does not contain basic groups that can form electrostatic interactions with sulfonic acid groups in dyestuff molecules. The substantivity of direct dyes for cotton arises from the configuration of the dye molecules. A common feature that distinguishes direct dyes from most acid wool dyes is their extended, linear, coplanar and conjugated structure (Vickerstaff, 1954; Marshall and Peters, 1947). A typical structure is shown in Fig. 8.31. This configuration enables the dye molecules to become

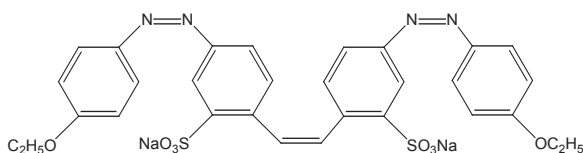

Figure 8.31 Typical cotton direct dye (Direct Yellow 12).

aligned with the cellulose chains in the amorphous regions of the fibre, where they can form various interactions (McCleary, 1953). These include multiple hydrogen bonds between suitably spaced hydrogen donor groups on the dye and lone pairs of electrons on the oxygen atoms of the hydroxyl groups on the cellulose. Another type of interaction arises from the coplanar configuration of the dyes, which enables adsorption of dye molecules onto each other, as a result of hydrophobic interactions between the aromatic groups (Hodgson, 1933).

Direct dyes are relatively cheap and are available in a wide range of shades. Their lightfastness ranges from poor to good, but their main disadvantage is that in many cases they do not satisfy today's stringent requirements for fastness to washing. With some dyes, fastness can be increased by various after-treatments (Broadbent, 2001c; Shore, 1995a). These include chelation of the dye with a copper compound, or treatment with a cationic fixing agent that interacts with the sulfonic acid groups in the dyestuff. The wetfastness of some direct dyes, in particular blacks, can be increased by after-treatment with formaldehyde. Post-treatment with a wrinkle-resistant finish, such as an amino/formaldehyde cross-linking agent, also improves wetfastness. The disadvantage of some of these after-treatments is that the shade and lightfastness of some dyes are adversely affected.

Direct dyes are applied, at around neutral pH, by raising the temperature of the dyebath to the boil, where it is held for around 1 h. During the dyeing cycle, sodium chloride or sodium sulfate is added at suitable intervals. The actual procedure varies with the substrate and type of equipment.

As mentioned above, cotton fibres do not contain groups that can ionize at pH values around neutral. When immersed in water, solids with a low dielectric constant, including cotton, acquire a negative surface charge as a result of orientation of water molecules at the solid/liquid interface (Peters, 1975). This charge tends to impede the sorption of negatively charged dye molecules. The electrolyte added during the dyeing cycle increases the dye uptake by providing counter-ions that disrupt this electrostatic barrier (Hunter, 1981). In addition to this effect, the electrolyte also enhances dye uptake by reducing dyestuff solubility via molecular aggregation.

8.4.7.4 Reactive dyes

The sorption of direct dyes by cotton is essentially a reversible process, because the forces binding the dye molecules to cellulose chains are relatively weak. Direct dyes can, therefore, diffuse out of a cotton substrate during washing. Reactive dyes form covalent bonds with cotton and offer an alternative to direct dyes for products that will be frequently laundered. Compared with other dyes used on cotton, which have been used for many years, reactive dyes are a fairly recent development. The first examples, introduced in the late 1950s, utilized a mono- or dichlorotriazine reactive group, an example of which is shown in Fig. 8.32 (Rattee, 1984; Shore, 1995b; Broadbent, 2001d). Under alkaline conditions, covalent bonds are formed between the dye molecules and cotton, as a result of replacement of the reactive chlorine atoms on the triazine ring by oxygen atoms from the cellulose hydroxyl groups. The role of the alkali is to produce Cell-O^- ions which react with the dye according to Fig. 8.33.

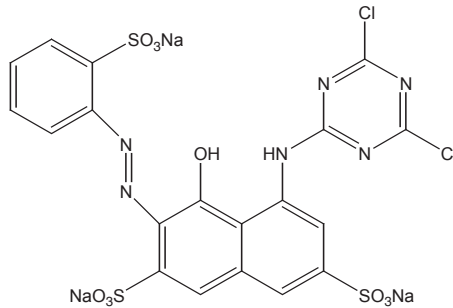

Figure 8.32 Typical cotton reactive dye (Reactive Red 1).

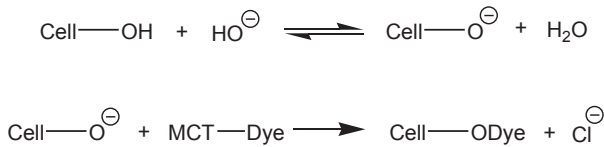

Figure 8.33 Reaction of cotton with a reactive dye (MCT = monochlorotriazine).

Since their introduction, all the major dyes manufacturers have developed ranges of reactive dyes for cotton. The chromophore of these dyes, which contains one or more sulfonic acid solubilizing group, is attached to a wide range of reactive groups. These include monofluorotriazine, trichloropyrimidine, dichloroquinoxaline, dichloropyrimidine, chlorofluoropyrimidine and nicotinyltriazine (Rattee, 1984; Shore, 1995b; Broadbent, 2001d). Like the chlorotriazines, these compounds also react with cotton by nucleophilic substitution of the chlorine, fluorine or nicotinyl labile leaving group. Another type of reactive dye used on cotton reacts by nucleophilic addition to a C=C double bond. In this case, the double bond is activated by an adjacent electrophilic sulfone group.

The usual exhaust method of applying reactive dyes to cotton under neutral pH conditions is similar to that used for direct dyes. Typically, this involves raising the temperature of the dyebath from 40 to 90°C, where it is held for times up to 90 min. Salt is added at intervals during the heating period, to promote exhaustion of the dyes. During the exhaustion phase, the dye does not react with the fibre and some migration/levelling between fibres can occur. Following the exhaustion phase, reaction with the fibre is induced by increasing the dyebath pH by the addition of alkali, as shown in Fig. 8.33. An undesirable side reaction that also occurs during the alkaline dye fixation stage is that some of the dye is hydrolyzed to an inactive form that cannot form covalent bonds with cotton. All the hydrolyzed dye must be removed by thorough rinsing, because it has a low affinity for cotton and its presence on the substrate results in poor wetfastness properties. A major difference in the application methods of direct and reactive dyes is in the washing off step. With the large amount of unfixed dye to remove, this step is much more time consuming and expensive for reactive dyes than it is for direct dyes. This factor, coupled with the

higher cost of reactive dyes, is a major reason why direct dyes have not been completely replaced by reactive dyes.

8.4.7.5 Vat, sulfur and azoic dyes

Vat, sulfur and azoic dyes rely on the formation of an insoluble pigment inside the fibre (Latham, 1995; Broadbent, 2001e; Senior, 1995; Shore, 1995c). The fastness levels of vat and azoic dyes are generally very good, but these dyes are relatively expensive. Sulfur dyes are cheaper, but their fastness properties vary from dye to dye, with most having fastness properties between those of direct and reactive dyes.

Most vat dyes have either an indigoid (Fig. 8.34) or an anthraquinone (Fig. 8.35) structure. As mentioned previously, the first vat dye used was indigo, which was originally obtained from natural sources. The method used to apply vat dyes to cotton involves reduction of the insoluble pigment to a water-soluble 'leuco' form, immediately before application, by a procedure called 'vatting'. The most important reducing agent used commercially is sodium hydrosulfite (hydros). A schematic of this reaction for the dyestuff Vat Red 42 is shown in Fig. 8.35.

In strongly alkaline conditions, the leuco forms of vat dyes are anionic and soluble in water. They can be exhausted onto cotton under alkaline conditions from long liquors, in the presence of an electrolyte such as sodium chloride or sodium sulfate. After absorption by the substrate, the leuco compound is oxidized back to the insoluble, coloured pigment inside the fibre. This can be done by exposure to air, or with an oxidizing agent such as hydrogen peroxide. Finally, the substrate is 'soaped off' at the boil with a dispersing agent. This step improves the fastness properties of the dyed fabric by removing any loosely bound surface pigment.

The first sulfur dyes were made by heating sawdust with sodium polysulfide (Senior, 1995). Although the structures of sulfur dyes are not well defined, they are

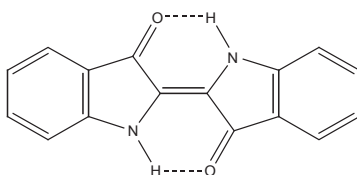

Figure 8.34 Chemical structure of indigo.

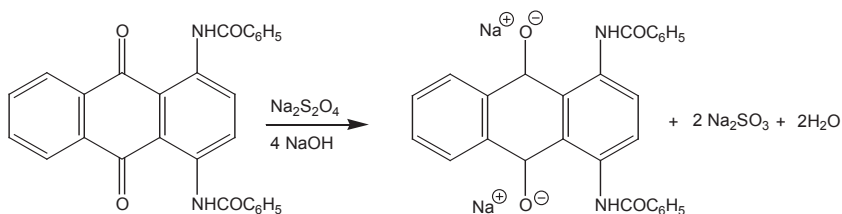

Figure 8.35 Conversion of Vat Red 42 to the sodium salt of the leuco form by reduction.

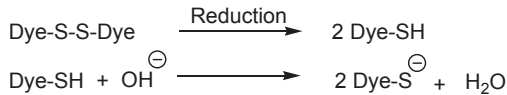

Figure 8.36 Solubilization of sulfur dye by reduction under alkaline conditions.

generally polymeric compounds, with sulfur-containing aromatic heterocyclic units linked by di- or polysulfide bonds (Senior, 1995). As for vat dyes, the methods used to apply sulfur dyes to cotton involve converting the insoluble pigment form of the dyestuff into a water-soluble compound by vatting. This is achieved by reduction of the disulfide bonds of the individual heteroaromatic units to thiol groups. The reduction products are then solubilized under strongly alkaline conditions by ionization of the thiol groups to thiolate anions, as shown in Fig. 8.36.

After exhaustion onto the substrate in the presence of salt, followed by diffusion to the fibres, the water-soluble leuco compounds are converted back to insoluble polymeric pigments by oxidizing the thiolate ions to disulfide bonds linking the aromatic units.

Sulfur dyes have a lower reduction potential than vat dyes and are easier to convert to the leuco form (Broadbent, 2001e). This is traditionally done with sodium sulfide, although sodium hydrosulfide is now also used (Senior, 1995). Sodium sulfide is very effective and relatively inexpensive. There are, however, some environmental and safety issues associated with its use, including disposal of the dyebath effluent and the evolution of hydrogen sulfide. Sodium hydrosulfite, which is used with vat dyes, is considered to be unsuitable for vatting many sulfur dyes because of the possibility of over-reduction of the dyestuff. When this occurs, the colour yield is decreased because the over-reduced dye cannot be readily oxidized back to the coloured pigment form. Alternative organic reducing agents, such as glucose, can be used and these would avoid the problem of over-reduction. The alternative chemicals are, however, less effective reducing agents than sodium sulfide. They react more slowly with the dyes and require higher vatting temperatures and increased concentrations of caustic soda to achieve sufficient levels of dyestuff reduction (Broadbent, 2001e; Senior, 1995). After exhaustion of the leuco compound, the cotton is rinsed and then an oxidation step is carried out to produce the pigment form of the dyestuff. Finally, the goods are soaped off to maximize the fastness properties by removing any surface pigment.

Azoic dyes are insoluble pigments that are precipitated inside cotton fibres by reaction of a diazonium compound with a coupling agent (usually a naphthol), as shown in Fig. 8.37 (Shore, 1995c). The diazotization step can be carried out in the dyebath, in which case it is important to keep the temperature below 5°C by the addition of ice. Alternatively, a stabilized diazonium salt can be used. As for vat and sulfur dyes, maximum fastness is achieved by soaping off at high temperature. These dyes, which produce bright colours with very high fastness properties, were very important in the past, but have now been largely replaced by reactive dyes.

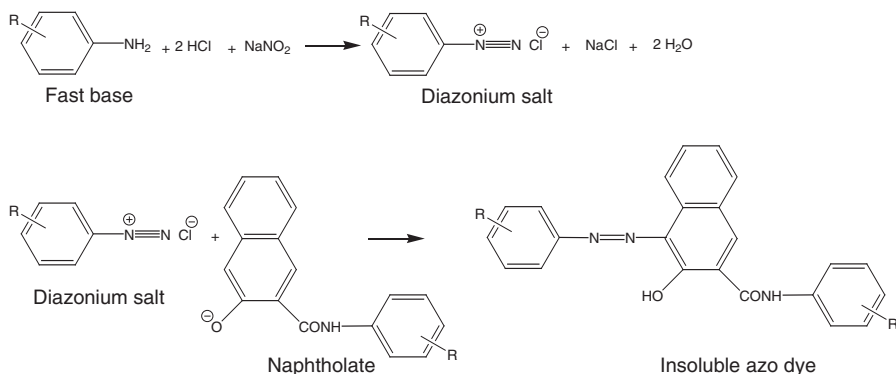

Figure 8.37 Reaction scheme for formation of a diazonium salt (fast colour salt) and coupling with a naphtholate.

8.4.7.6 Continuous methods of cotton dyeing

Unlike batch processes, which rely on the exhaustion of dyes from the dyebath onto the substrate, continuous dyeing methods involve a series of uninterrupted steps in which the fabric is impregnated with a solution of dyes and chemicals, followed by a dye fixation step, a rinsing step and finally drying. Application of dyes and chemicals is usually done with a pad mangle. In this, the fabric passes through a solution of dyes and chemicals and then through rollers which squeeze out the excess liquor. Various forms of this equipment are used in industry. Fixation is usually achieved by steaming or baking.

Semi-continuous methods are also used for dyeing cotton fabrics. One method, usually used for reactive dyes, is pad-batch. In this, after the pad application of an alkaline dye solution, the fabric is rolled onto a perforated cylinder and 'batched' for several hours at room temperature, during which time the dyes react with the cotton.

The fabric is washed off by pumping water through the batch via the perforated cylinder. Both continuous and semi-continuous dyeing methods are particularly suited to cotton colouration where, unlike wool, very long lengths of fabric are often dyed to a single shade.

8.4.8 Environmental issues of cotton processing

Removal of the starch-based sizes, applied to facilitate weaving, results in liquors that are mostly biodegradable. The breakdown of these compounds, however, consumes large amounts of oxygen, which can adversely affect ecosystems. This problem is addressed by treatment of the effluent before it is discharged from the factory; and also by using sizes that can be recovered and re-used.

As discussed previously, methods of dyeing cotton by exhaustion rely on the use of high concentrations of salt (80–100 g/L is typical) to promote the uptake of dye by the substrate. Even under optimum dyeing conditions, the equilibrium uptake of dyes is much lower than for non-cellulosic fibres, and for some reactive dyes may be as

low as 50%. The application of reactive, vat and sulfur dyes also requires high concentrations of alkali. In many countries, concerns about the high concentrations of electrolytes and colour, particularly in the effluent from reactive dye liquors, has resulted in the introduction of very stringent legislation. Although methods that use low liquor ratios generally give higher dyebath exhaustion levels, the effluent still contains high concentrations of salt. Continuous methods, based on pad application of dyes, also give better utilization of dyes and chemicals. Another approach for improving dyebath exhaustion and reducing the salt requirements in exhaust dyeing is to increase dye substantivity by fibre modification (Lewis and McIlroy, 1997). This is generally done by introducing cationic sites into the cotton that can interact with anionic dyes. Early methods involved the introduction of amino groups by reaction of cotton with compounds such as 2-aminosulfuric acid under alkaline conditions (Lewis and McIlroy, 1997; Guthrie, 1947). Other treatments that have been recently reported include dendrimers (Burkinshaw et al., 2000), poly(vinylamine chloride) (Wei et al., 2005), 1-acrylamido-2-hydroxy-3-trimethylammonium propane chloride (Wang and Lewis, 2002), chloropropionyl chloride (Lei and Lewis, 1991), and cationic monomers grafted onto cotton with UV radiation (Jang et al., 2001).

Most work has focused on treatment with a fibre-reactive quaternary ammonium compound (Lewis and McIlroy, 1997; Rupin, 1976; Evans et al., 1984). One compound that has been widely studied is 2,3-epoxypropyltrimethylammonium chloride (Hauser and Tappa, 2001). The reaction of this with cotton is shown in Fig. 8.38.

The most convenient method of pretreating cotton with cationic agents would be by an exhaustion method in the dyeing machine, immediately before dyeing. Pretreatment by exhaustion with the water-soluble cellulose analogue, chitosan (partly deacetylated poly (N-acetyl-D-glucosamine), has been shown to give an increase in the dyebath exhaustion of direct dyes and also a marked improvement in the coverage of neps of immature fibres (Rippon, 1984). Low-molecular weight compounds, such as the cationic agent shown in Fig. 8.38, have little substantivity for cotton, however. They can be applied by a pad-bake procedure, but with this method the reagents tend to migrate to the surface of the fabric during the treatment. Migration results in

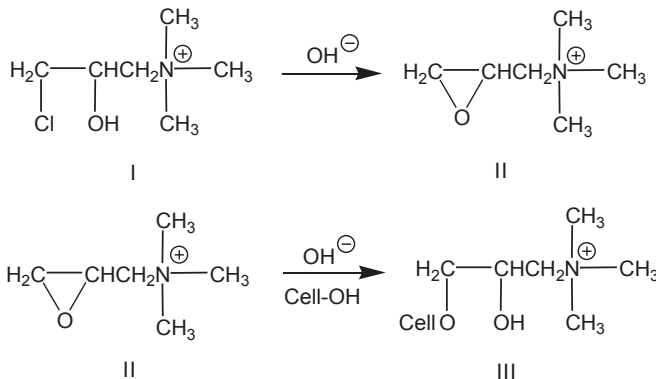

Figure 8.38 Reaction scheme for introduction of cationic groups into cotton.

a non-uniform distribution of the cationic sites, which leads to ring dyeing (Evans et al., 1984).

Application of the 2,3-epoxypropyltrimethylammonium chloride by a cold pad/batch method has been claimed to give an even pretreatment and, hence, excellent dye penetration (Hauser and Tappa, 2001). A decrease in lightfastness of dyes often occurs on cotton modified with cationic reagents, particularly with polymer treatments. This has been attributed to ring dyed effects and the hydrophilic nature of some polymers (Wang and Lewis, 2002). Despite their benefits in improving dye uptake, none of the cationic treatments appear to have made an impact in the market, presumably because of the cost of an additional processing step. There are also issues involving AOX associated with the use of compounds that contain labile chlorine atoms (Lewis and McIlroy, 1997).

8.5 Other vegetable fibres

There is a wide variety of vegetable fibres, although only a few are important commercially. Vegetable fibres may be classified according to their source in plants, the processing system used for their conversion into fibres and yarns, or on particular functional criteria related to bending and torsional properties (Young, 1997; Batra, 1998). With the exception of the seed hair fibres (cotton, coir and kapok), vegetable fibres are multicellular and consist of bundles of cells (called ultimates) bound together by natural resins or gums. Depending on the species, the ultimates vary in dimensions but are generally packed tightly together in a polygonal arrangement that is aligned lengthwise along the fibre axis (Young, 1997; Batra, 1998). The material between the cells, the middle lamella, forms a thin, mostly uniform layer that surrounds each ultimate. The morphological structures of the common vegetable fibres are covered in a number of excellent reviews (Young, 1997; Batra, 1998; Rowell and Stout, 1998). More data about other vegetable fibres, such as abaca, bamboo, coir, flax, hemp, jute, kenaf, ramie, one can find in this Handbook in the relevant chapters.

Chemically, vegetable fibres consist of variable quantities of cellulose, hemicellulose, pectin and lignin (Young, 1997; Batra, 1998; Turner, 1953; McGovern, 1990). The lignin content can vary from zero or very low (cotton and flax), through intermediate levels (jute and kenaf), to almost half the weight of the fibre (coir). Vegetable fibres are, therefore, sometimes referred to as 'lignocellulosic' in composition. The properties of the vegetable fibres can be improved significantly by the chemical treatments that are commonly used for cotton. Treatments include the action of alkalis (mercerization), cross-linking, acetylation, cyanoethylation, as well as dyeing and bleaching. These are briefly discussed in the following sections.

8.5.1 Mercerization

The most important chemical treatment for improving the properties of bast and leaf fibres is treatment with alkali. The effect of treating vegetable fibres with mercerization strength sodium hydroxide varies from fibre to fibre, but generally results in fibre

swelling, increased dye uptake and, for fibres with high lignin content, increased crystallinity due to removal of lignin or cementing material (Batra, 1998). Mercerization is an important preparation for flax (linen), jute, ramie and other vegetable fibres (Batra, 1998; Sloan, 1974; Lambrinou, 1975).

Flax fibres have nodes or cross-shaped dislocations. These appear to be minute fissures or local separation of fibrils associated with regions of low density. They are believed to be responsible for the ease of bending, poor abrasion resistance and ease of creasing of linen fabrics (Batra, 1998). During mercerization with caustic soda, the whole fibre, including the nodes, swells. This gives a more uniform structure and leads to improved wet abrasion resistance (Batra, 1998; Lambrinou, 1975). As for cotton, mercerization improves the dye uptake of linen (Sloan, 1974). It can also be used to reduce 'embrittlement' caused by cross-linking treatments and to cover yarn unevenness (reediness) that is a common characteristic of linen yarn (Sloan, 1974). Liquid ammonia has also been investigated as an alternative to caustic soda, with similar effects, but with improved dye penetration and wrinkle recovery of the treated fabric (Lambrinou, 1975).

Mercerization of jute under tension with caustic soda gives a fibre with an improved appearance and handle (Rowell and Stout, 1998). If conducted without tension (slack mercerization), fibre shrinkage occurs, which gives the fibre a wool-like appearance. The stability of the crimp is poor, however, and the treatment does not confer elasticity on the fibres.

8.5.2 Cross-linking

The chemistry of cross-linking of vegetable fibres is similar to that for cotton (Section 8.5.5) although it is generally more complicated due to the structural differences. Cross-linking is used with selected fibres to improve fibre properties. For example, the wet crease recovery of linen can be improved by cross-linking, but improvement of dry crease resistance is more difficult. In general, however, dry crease resistance is only possible at the expense of abrasion resistance. During an acid-catalyzed pad-dry-cure treatment with a cross-linking agent, the acid catalyst tends to migrate during the drying step and to concentrate in the fibre nodes. This leads to local weakening of the fibre (Batra, 1998).

8.5.3 Acetylation and cyanoethylation

Jute and kenaf have been treated with acetic anhydride to give acetylated derivatives that show reduced swelling. This effect, which is due to the conversion of hydrophilic hydroxyl groups to less polar acetyl ester groups, is advantageous when these fibres are incorporated into fibre/board composites (Rowell and Stout, 1998). Reaction of jute with acrylonitrile converts the cellulosic hydroxyl groups to cyanoethyl groups. The properties of cyanoethylated cotton are well known and provide improved stability to attack from acids and heat (Compton, 1955). Cyanoethylation of jute yarns to a total of 2.8% nitrogen improves resistance to heat, acids and rotting. The high cost of such a treatment, however, limits its commercial use (Rowell and Stout, 1998).

8.6 Future trends

Although it is likely that the growing demand for textiles will be largely met by an increase in the production of synthetic fibres, natural protein and cellulosic fibres will continue to be important. The protein fibres, wool and silk, will satisfy the demands of niche markets and there will probably be an increase in their use in blends, both with other natural fibres and also synthetics. Blends will enable the attributes of the protein fibres to be coupled with the easy-care properties of synthetic fibres. The demand for cotton is likely to increase because of its extensive use in leisurewear garments.

Increasing awareness of environmental issues, particularly by consumers, will continue to drive research to produce natural fibre products that can meet increasing demanding legislation, such as the European Union's Registration, Evaluation Authorization and Restriction of Chemicals (EU, 2006). This environment will result in significant changes to the types of chemicals used in the dyeing and finishing of all textiles produced from both synthetic and natural fibres. Over the past few years, many ranges of dyes used on natural fibres have been withdrawn from the market. This rationalization is likely to continue, both for environmental and economic reasons. Work is likely to continue on developing methods for dyeing cotton that use less salt and give higher exhaustion levels than possible at the moment. The introduction of self-cleaning treatments, based on titanium dioxide, that can catalyze the breakdown of organic dirt awaits the discovery of a system that does not destroy dyes or other chemical treatments that have been applied to the fabric.

Appendix: abbreviations

AOX	adsorbable organic halides
BTCA	1,2,3,4-butanetetracarboxylic acid
CMC	cell membrane complex
CSIRO	Commonwealth Scientific and Industrial Research Organisation
DCCA	dichloroisocyanuric acid
DFE	differential frictional effect
DMDHEU	1,3-dimethylol-4,5-dihydroxyethylene urea
DMU	<i>N, N'</i> -dimethylol urea
EDTA	ethylene diamine tetraacetic acid
FWA	fluorescent whitening agent
IR	insect resist
IWS	International Wool Secretariat
omf	on mass of fibre
PMS	permonosulfuric acid
SEM	scanning electron microscopy
TEM	transmission electron microscopy
TMM	trimethylol melamine
UV	ultraviolet

Acknowledgements

We would like to thank former colleagues at CSIRO Materials Science and Engineering (now CSIRO Manufacturing) for help with some of the material. We also thank Richard de Peyer of the Silk Industry Museum, Macclesfield, Cheshire, UK for a sample of raw silk.

References

- Abbott, G.M., Robinson, G.A., 1977. The corona treatment of cotton. Part II: yarn and fabric properties. *Text. Res. J.* 47, 199–202.
- Abrahams, D.H., 1994. Improving on mercerizing processing. *Am. Dyest. Rep.* 83, 78–124.
- Alexander, P., Hudson, R.F., 1963. In: Earland, C. (Ed.), *Wool: Its Chemistry and Physics*, second ed. Chapman and Hall, London.
- Alexander, P., Carter, D., Hudson, R.F., 1949. The treatment of wool with acid permanganate solutions. *J. Soc. Dye. Colour.* 65, 152–161.
- Alexander, P., Carter, D., Earland, C., 1951a. The reaction of wool with organic chloramines. *J. Soc. Dye. Colour.* 67, 17–22.
- Alexander, P., Carter, D., Earland, C., 1951b. The role of the disulphide bond in reactions which render wool non-felting. *J. Soc. Dye. Colour.* 67, 23–27.
- Alexander, P., Fox, M., Hudson, R.F., 1951c. The reaction of oxidising agents with wool. *Biochem. J.* 49, 129–138.
- Andrews, M.W., Inglis, A.S., Williams, V.A., 1966. Chemical changes in the cuticle of oxidized wool. *Text. Res. J.* 36, 407–412.
- Anon, 1960. 'Shrink-Resist Processes for Wool: Commercial Methods', *Wool Science Review*, 18. International Wool Secretariat, Ilkley, UK, pp. 18–37.
- Anon, 1968. 'Shrink-Resist Treatments Based on DCCA', *Wool Science Review*, 34. International Wool Secretariat, Ilkley, UK, pp. 1–9.
- Arai, K., 1973. In: Ceresa, R. (Ed.), *Block and Graft Copolymerisation*, vol. 1. Wiley and Sons, London, p. 269.
- Arnold, L.N., Rippon, J.A., 2010. Continuous mercerisation of cotton sliver under tension offers the potential for new products. *Int. Dyer* 167, 12–16.
- Asquith, R.S., 1979. Reactivity of chemical groups in keratin. In: Parry, D.A.D., Creamer, L.K. (Eds.), *Fibrous Proteins: Scientific, Industrial and Medical Aspects*, vol. 1. Academic Press, London, pp. 371–391.
- Asquith, R.S., Puri, A.K., 1968. Stability to aftertreatments of wool set in thioglycolic acid. *J. Soc. Dye. Colour.* 84, 461–462.
- Ball, P., Meyer, U., Yang, J., Zollinger, H., 1985. Erfahrungen beim reaktivfärben von seide. *Textilveredlung* 20, 88–89.
- Baltova, S., Valtcheva, E., 1998. Photochemical behaviour of natural silk. II: mechanism of fibroin photodestruction. *Polym. Degrad. Stab.* 60, 61–65.
- Baltova, S., Violeta, V., Valtcheva, E., 1998. Photochemical behaviour of natural silk. I: kinetic investigation of photoyellowing. *Polym. Degrad. Stab.* 60, 53–60.
- Barritt, J., Elsworth, F.F., 1948. The dyeing properties of chlorinated wool. *J. Soc. Dye. Colour.* 64, 23–33.
- Barton, J., 2000. 'It's a bugs life — or is it?' *Int. Dyer* 185 (9), 14–16.
- Batra, S.K., 1998. Other long vegetable fibers. In: Lewis, M., Pearce, E.M. (Eds.), *Handbook of Fibre Chemistry*, second ed. Marcel Dekker, New York, pp. 505–575.

- Baumann, H., 1979. Applied aspects of keratin chemistry. In: Parry, D.A.D., Creamer, L.K. (Eds.), *Fibrous Proteins: Scientific, Industrial and Medical Aspects*, vol. 1. Academic Press, London, pp. 299–391.
- Beal, W., Dickinson, K., Bellhouse, E., 1960. The dyeing of wool by solvent-assisted process. *J. Soc. Dye. Colour.* 76, 333–341.
- Bell, V.A., Lewis, D.M., Pailthorpe, M.T., 1984. Chemical treatments designed to modify the affinity of wool for dyes. *J. Soc. Dye. Colour.* 100, 223–231.
- Bendit, E.G., 1960. A quantitative X-ray diffraction study of the alpha-beta transformation in wool keratin. *Text. Res. J.* 30, 547–555.
- Bereck, A., Byrne, K.M., Rushforth, M.A., 1990. Developments in batch shrink-resist treatments for wool knitwear. In: *Proceedings of the 8th International Wool Textile Research Conference*, Christchurch, vol. 4. Wool Research Organisation of New Zealand, pp. 431–440.
- Bhat, N.V., Netravali, A.N., Gore, A.V., Sathianarayanan, M.P., Arolkar, G.A., Deshmukh, R.R., 2011. Surface modification of cotton fabrics using plasma technology. *Text. Res. J.* 81, 1014–1026.
- Bhoyro, A.Y., Church, J.S., King, D.G., O’Loughlin, G.J., Phillips, D.G., Rippon, J.A., 2001. Wool’s space age response: optim fine and optim max. In: *Proceedings of the Textile Institute 81st World Conference*, Melbourne, Australia (CD ROM, 2001).
- Blanchard, E.J., Graves, E., 2002. Polycarboxylic acids for flame resistant cotton/polyester carpeting. *Text. Res. J.* 72, 39–43.
- Bowman, F.H., 1908. *The Structure of the Wool Fibre*. Macmillan, London, pp. 435–437.
- Bradbury, J.H., 1973. The structure and chemistry of keratin fibers. In: Anfinsen Jr., C.B., Edsall, J.T., Richards, F.M. (Eds.), *Advances in Protein Chemistry*, vol. 27. Academic Press, New York, pp. 111–211.
- Bradbury, J.H., Chapman, G.V., King, N.L.R., 1965. The chemical composition of wool. II: analysis of the major histological components produced by ultrasonic disintegration. *Aust. J. Biol. Sci.* 18, 353–364.
- Brady, P.R., 1990. Penetration pathways of dyes into natural fibres. In: *Proceedings of the 8th International Wool Textile Research Conference*, vol. 4. Wool Research Organisation of New Zealand, Christchurch, pp. 217–226.
- Brady, P.R. (Ed.), 1997. *Finishing and Wool Fabric Properties*. CSIRO Wool Technology, Geelong, Australia.
- Broadbent, A.D., 2001a. ‘Natural Cellulose Fibres’ in *Basic Principles of Textile Coloration*. Society of Dyers and Colourists, Bradford, UK, pp. 70–91.
- Broadbent, A.D., 2001b. ‘Dyeing Machinery’, in *Basic Principles of Textile Coloration*. Society of Dyers and Colourists, Bradford, UK, pp. 215–239.
- Broadbent, A.D., 2001c. ‘Dyeing Cellulosic Fibres with Direct Dyes’, in *Basic Principles of Textile Coloration*. Society of Dyers and Colourists, Bradford, UK, pp. 287–306.
- Broadbent, A.D., 2001d. ‘Reactive Dyes’, in *Basic Principles of Textile Coloration*. Society of Dyers and Colourists, Bradford, UK, pp. 332–357.
- Broadbent, A.D., 2001e. ‘Vat Dyes’, in *Basic Principles of Textile Coloration*. Society of Dyers and Colourists, Bradford, UK, pp. 358–387.
- Broadbent, P.J., Rigout, L.A., 2013. Wool printing. In: Lewis, D.M., Rippon, J.A. (Eds.), *The Coloration of Wool and Other Keratin Fibres*. Society of Dyers and Colourists, Bradford, UK, pp. 393–430.
- Burkinshaw, S.M., 2013. Dyeing wool with metal-complex dyes. In: Lewis, D.M., Rippon, J.A. (Eds.), *The Coloration of Wool and Other Keratin Fibres*. Society of Dyers and Colourists, Bradford, UK, pp. 229–250.

- Burkinshaw, S.M., Mignanelli, M., Froehling, P.E., Bide, M.J., 2000. The use of dendrimers to modify the dyeing behaviour of reactive dyes on cotton. *Dyes Pigments* 47, 259–267.
- Burley, R.W., 1955. Some observations of the extension, contraction and supercontraction of wool fibres. In: *Proceedings of the 1st International Wool Textile Research Conference*, Melbourne, vol. D, pp. 88–117.
- Byrne, K.M., 1995. Machine-washable knitwear – production routes. In: Carr, C.M. (Ed.), *Chemistry of the Textiles Industry*. Blackie Academic and Professional, London, pp. 186–209.
- Byrne, K.M., Smith, P., Jackson, J., Lewis, J., 1984. Kroy offers control and versatility. *Text. Horiz.* 4, 26–28.
- Byrne, K.M., Bourne, W., Clark, M., Duffield, P.A., 1995a. Zero AOX garment dyeing. In: *Proceedings of the 9th International Wool Textile Research Conference*, vol. 1. Cita' degli studi biella, Biella, Italy, pp. 191–198.
- Byrne, K.M., Rakowski, W., Ryder, A., Havis, S., 1995b. The influence of glow discharge plasma treatment on the wool production pipeline. In: *Proceedings of the 9th International Wool Textile Research Conference*, vol. 4. Cita' degli studi biella, Biella, Italy, pp. 422–429.
- Cai, Z., Qiu, Y., 2003. Using an aqueous epoxide in *Bombyx mori* silk fabric finishing. *Text. Res. J.* 73, 42–46.
- Cai, Z., Jiang, G., Yang, S., 2001. Chemical finishing of silk. *Color. Technol.* 117, 161–165.
- Calamari, T.A., Schreiber, S.P., Cooper Jr., A.S., 1971. Liquid ammonia modification of cellulose in cotton and polyester/cotton textiles. *Text. Chem. Colorist* 3, 234–238.
- Chapman, B.M., 1974. A model for the crease recovery of fabrics. *Text. Res. J.* 44, 531–538.
- Cheng, H., Kai, S., 1998. Easy-care finishing of silk fabrics with a novel multifunctional epoxide. Part 1. *J. Soc. Dye. Colour.* 114, 359–362.
- Cheng, H., Yejuan, J., Kai, S., 2000. Easy care finishing of silk fabrics with a novel multifunctional epoxide, Part 2. *J. Soc. Dye. Colour.* 116, 204–207.
- Chu, K.Y., Provost, J.R., 1987. The dyeing and printing of silk fabrics. *Rev. Prog. Coloration* 17, 23–28.
- Cleyman, J., 2010. Anti-insect treatments for outdoorwear, tents and battledress uniforms. *Int. Dyer* 195, 23–25.
- Cockett, K.R.F., 1979. 'Production of Superwash Knitwear by Batch Processing Routes', *Wool Science Review*, 56. International Wool Secretariat, Ilkley, UK, pp. 2–44.
- Compton, J., 1955. Preliminary report on service uses of cyanoethylated cotton products. *Text. Res. J.* 27, 222–231.
- Connell, D.L., Huddleston, K.M., December 1997. 'Method for the treatment of wool', US Patent, vol. 5, pp. 697–983.
- Connell, D.L., 2003. Wool finishes: the control of shrinkage. In: Heywood, D. (Ed.), *Textile Finishing*. Society of Dyers and Colourists, Bradford, UK, pp. 372–397.
- Cook, J.R., Fleischfresser, B.E., 1989. Relationship between set and bulk of package-dyed wool yarns. *J. Soc. Dye. Colour.* 105, 19–26.
- Cookson, P.G., Fincher, K.W., Brady, P.R., 1991. Minimising the impairment of the physical properties of wool during dyeing by restricting the level of permanent set. *J. Soc. Dye. Colour.* 107, 135–138.
- Cookson, P.G., Brady, P.R., Fincher, K.W., Duffield, P.A., Smith, S.M., Reincke, K., Schreiber, J., 1995. The Basolan AS Process: a new concept in wool dyeing. *J. Soc. Dye. Colour.* 111, 228–236.
- Currie, R., 2001. Silk. In: Frank, R.R. (Ed.), *Silk, Mohair, Cashmere and Other Luxury Fibres*. Woodhead Publishing, Cambridge, UK, pp. 1–67.

- Dang, N.Y., Ma, W., Zhang, S.F., Tang, T.T., Yang, J.Z., 2010. Studies on anti-wrinkling properties of silk fabrics dyed with reactive and crosslinking dyes. *Text. Res. J.* 80, 374–382.
- Datta, R.K., Nanavaty, M., 2005. *Global Silk Industry: A Complete Source Book*. Universal Publishers, Boca Raton, FL, pp. 186–188.
- De Boos, A.G., 1976. The effect of surface elastomers on the frictional contribution to the wrinkling of nylon. *J. Text. Inst.* 67, 107–110.
- de Fries, W., Altenhöfen, V., Föhles, J., Zahn, H., 1983. A protein chemical investigation of the chlorine-Hercosett process. *J. Soc. Dye. Colour.* 98, 13–16.
- Delmenico, J., Wemyss, A.M., 1969. The connection between the annealing, cross-linking and wrinkling of wool. *J. Text. Inst.* 60, 78–81.
- Denby, E.F., 1980. The interconversion of stress-relaxation and recovery: some applications. *J. Text. Inst.* 71, 201.
- Dickerson, D.K., Lane, E.F., Dolores, R.F., 1999. 'Naturally Colored Cotton: Resistance to Changes in Color and Durability when Refurbished with Selected Laundry Aids', Fresno, California. California Agricultural Technology Institute, California State University. Available from: <http://cati.csufresno.edu/ip/rese/99/990901.pdf>.
- Douthwaite, F.J., Lewis, D.M., 1994. The formation of cysteine-S-sulphonate groups in wool and the effect on shrink-resistance. *J. Soc. Dye. Colour.* 110, 304–307.
- Duffield, P.A., 2013. Dyeing wool with acid and mordant dyes. In: Lewis, D.M., Rippon, J.A. (Eds.), *The Coloration of Wool and Other Keratin Fibres*. Society of Dyers and Colourists, Bradford, UK, pp. 205–228.
- Duffield, P.A., Lewis, D.M., 1985. The yellowing and bleaching of wool. *Rev. Prog. Coloration* 15, 38–51.
- Dyer, J.M., Bringans, S.D., Aitken, G.D., Joyce, N.I., Bryson, W.G., 2005. Identification of yellow chromophores in non-scourable yellowed wool. In: *Proceedings of the 11th International Wool Textile Research Conference, Leeds, Paper 101 FWSA (CD ROM)*.
- Earle Jr., R.H., Saunders, R.H., Kangas, L.R., 1970. The chemistry of the chlorination/Hercosett resin shrink-proofing process. In: *Proceedings of the 4th International Wool Textile Research Conference*. Interscience, San Francisco. New York, pp. 707–714.
- El-Zawahry, M.M., El-Mallah, M.H., El-Sham, S., 2009. An innovative study on dyeing silk fabrics by modified phospholipid liposomes. *Color. Technol.* 125, 164–171.
- EU, 2006. *Registration, Evaluation and Authorisation and Restriction of Chemicals. Regulation No. 1907/2006*.
- Evans, G.E., Shore, J., Stead, C.V., 1984. Dyeing behaviour of cotton after pretreatment with reactive quaternary compounds. *J. Soc. Dye. Colour.* 100, 304–315.
- Evans, D.J., Leeder, J.D., Rippon, J.A., Rivett, D.E., 1985. Separation and analysis of the surface lipids of the wool fibre. In: *Proceedings of the 7th International Wool Textile Research Conference, vol. 1. Society of Fiber Science and Technology, Japan, Tokyo*, pp. 135–142.
- Farnworth, A.J., Delmenico, J., 1971. *Permanent Setting of Wool*. Merrow Publishing, Darlington, UK.
- Feldtman, H.D., Leeder, J.D., 1984. Effects of polar organic solvents on the abrasion resistance of wool fabrics. *Text. Res. J.* 54, 26–31.
- Feldtman, H.D., Leeder, J.D., 1985. Counteracting damage during processing. In: *Proceedings of the 7th International Wool Textile Research Conference, vol. 4. Society of Fiber Science and Technology, Japan, Tokyo*, pp. 471–480.
- Feldtman, H.D., McPhee, J.R., 1964. Effect of temperature on the felting of shrink-resistant wool. *Text. Res. J.* 34, 199–206.

- Feldtman, H.D., Leeder, J.D., Rippon, J.A., 1983. The role of fibre structure in wool fibre and fabric processing. In: Postle, R., Kawabata, S., Niwa, M. (Eds.), *Objective Evaluation of Apparel Fabrics*. Textile Machinery Society of Japan, Osaka, Japan, pp. 125–134.
- Feughelman, M., 1980. Basic wool physics. In: Proc 6th Int Wool Conf, Pretoria, vol. 1, pp. 35–53.
- Fraser, R.D.B., Macrae, T.P., 1982. The fine structure of protein fibers. In: Breuer, M.M. (Ed.), *Milton Harris, Chemist, Innovator and Entrepreneur*. American Chemical Society, Washington, DC, pp. 109–137.
- Fraser, R.D.B., Jones, L.N., Macrae, T.P., Suzuki, E., Tulloch, P.A., 1980. The fine structure of wool. In: *Proceedings of the 6th International Wool Textile Research Conference*, Pretoria, South Africa, vol. 1. South African Wool and Textile Research Institute, Pretoria, pp. 1–33.
- Freddi, G., Shiozaki, H., Allara, G., Goto, Y., Yasui, H., Tsukada, M., 1996. Chemical modification of tussah silk fabrics with ethyleneglycol diglycidyl ether by a pad-batch method. *J. Soc. Dye. Colour.* 122, 88–94.
- French, A.D., 1985. Enzymatic degradation of cellulose. In: Nevell, T.P., Zeronian, S.H. (Eds.), *Cellulose Chemistry and its Applications*. Ellis Horwood, Chichester, pp. 312–343.
- Freytag, R., Donzé, J.J., 1983. Alkali treatment of cellulose. In: Lewin, M., Sello, S.B. (Eds.), *Handbook of Fibre Science and Technology*, vol. 1. Marcel Dekker, New York, pp. 93–165. Part A.
- Garfield, S., 2000. *Mauve: How One Man Invented a Colour that Changed the World*. Faber and Faber, London.
- Garrett, G., 1964. Practical aspects of the bleaching of cellulosic materials. *J. Soc. Dye. Colour.* 80, 117–123.
- Giles, C.H., 1975. Dye-fibre bonds and their investigation. In: Bird, C.L., Boston, W.S. (Eds.), *The Theory of Coloration of Textiles*. The Dyers Company Publication Trust, Bradford, UK, pp. 41–110.
- Gillespie, J.M., 1990. The proteins of hair and other hard α -keratins. In: Goldman, R.D., Steinert, P.M. (Eds.), *Cellular and Molecular Biology of Intermediate Filaments*. Plenum Press, New York, pp. 95–128.
- Glover, B., 1998. Doing what comes naturally in the dyehouse. *J. Soc. Dye. Colour.* 114, 4–7.
- Glover, B., Pierce, J.H., 1993. Are natural colorants good for your health? *J. Soc. Dye. Colour.* 109, 5–7.
- Goel, G., Rani, A., 2010. Optimisation of the dyeing process for reactive dyes and their fastness properties on Muga silk fabric. *Int. Dyer* 195 (6), 32–36.
- Gogek, C.J., Olds, W.F., Valko, E.I., Shanley, E.S., 1969. Effect of preswelling on durable-press performance of cotton. *Text. Res. J.* 39, 543–547.
- Goldfinger, G., 1977. Changes in internal scattering are sufficient to explain color changes due to mercerisation. *Text. Res. J.* 47, 633–634.
- Grierson, S., 1984. Vegetable dyes of Scotland. *J. Soc. Dye. Colour.* 100, 209–211.
- Greenwood, G., 1987. Mercerisation and liquid ammonia treatment of cotton. *J. Soc. Dye. Colour.* 103, 342–348.
- Guise, G.B., 1977. Poly(carbamoylsulfonates) (bisulfite adducts of polyisocyanates). *J. Appl. Polym. Sci.* 21, 3427–3443.
- Gulrajani, M.L., 1992. Degumming of silk. *Rev. Prog. Coloration* 22, 79–89.
- Gulrajani, M.L., 1993. Dyeing of silk with reactive dyes. *Rev. Prog. Coloration* 23, 51–56.
- Guthrie, J.D., 1947. Introduction of amino groups into cotton fabric by use of 2-aminoethylsulfuric acid. *Text. Res. J.* 17, 625–629.
- Haefely, H., 1989. Enzyme treatment for wool. *Textilveredlung* 24 (7), 271–276.

- Hall, R.O., 1937. Fibre structure in relation to Fur dyeing. *J. Soc. Dye. Colour.* 53, 341–344.
- Hampton, G.M., Rattee, I.D., 1979. Surface barrier effects in wool dyeing. Part I: the location of the surface barrier. *J. Soc. Dye. Colour.* 95, 396–399.
- Harrowfield, B.V., 1987. 'Early-stage worsted processing – from scoured wool to top'. In: *Wool Science Review*, 64. International Wool Secretariat, Ilkley, UK, pp. 44–80.
- Hauser, P.J., Tappa, A.H., 2001. Improving the environmental and economic aspects of cotton dyeing using a cationised cotton. *Color. Technol.* 117, 282–288.
- Hawkes, J.A., Hamilton, P., 2013. Wool dyeing machinery. In: Lewis, D.M., Rippon, J.A. (Eds.), *The Coloration of Wool and Other Keratin Fibres*. Society of Dyers and Colourists, Bradford, UK, pp. 157–203.
- Heap, S.A., 1978. Liquid Ammonia Treatment of Cotton Fabrics, Especially as a Pretreatment for Easy-Care Finishing, vol. 16. Textile Institute and Industry, pp. 387–390.
- Hesse, A., Thomas, H., Höcker, H., 1995. Zero-AOX shrink-proofing treatment for wool top and fabric. *Text. Res. J.* 65, 355–361.
- Hickman, W.S., 1995. Preparation. In: Shore, J. (Ed.), *Cellulosics Dyeing*. Society of Dyers and Colourists, Bradford, UK, pp. 81–151.
- Hill, D.J., 1997. Is there a future for natural dyes? *Rev. Prog. Coloration* 27, 18–25.
- Hodgson, H.H., 1933. 'Colour and constitution from the standpoint of recent electronic theory – Part VI'. *J. Soc. Dye. Colour.* 49, 213–216.
- Höcker, H., Thomas, H., Küsters, A., Herrling, J., 1994. Färben von plasmabehandelte wolle. *Melliand Textilberichte Int. Text. Rep.* 75, 506–512.
- Hojo, H., 1985. Improvement of wool fibres by removing exocuticle in the presence of metallic ions. In: *Proceedings of the 7th International Wool Textile Research Conference*, vol. 4. Society of Fiber Science and Technology, Japan, Tokyo, pp. 322–331.
- Holme, I., 2006. Sir William Henry Perkin: a review of his life, work and legacy. *Color. Technol.* 122, 235–251.
- Holme, I., 2010. Ancient luxury for a technological age: recent developments in silk dyeing and finishing. *Int. Dyer* 195 (6), 11–13.
- Holt, L.A., Saunders, J.A., 1986. A fluorescence microscopy study of the diffusion of some nonionic compounds into wool from solvent mixtures. *Text. Res. J.* 56, 415–418.
- Holt, L.A., Stapleton, I.W., 1988. The distribution of some fluorescent anionic surfactants applied to wool. *J. Soc. Dye. Colour.* 104, 387–392.
- Holt, R.R.D., 1990. Quick response: late stage coloration. In: *Proceedings of the 8th International Wool Textile Research Conference*, vol. 4. Wool Research Organisation of New Zealand, Christchurch, pp. 107–116.
- Hori, T., Zollinger, H., 1987. Influence of fibre morphology and swelling water on the diffusion of dyes in wool. *Melliand Textilberichte Int. Text. Rep.* 9, E294–295. English Edition.
- Hu, C., Jin, Y., 2002. Wash and wear finishing of silk fabrics with a water soluble polyurethane. *Text. Res. J.* 72, 1009–1012.
- Hunter, R.J., 1981. *Zeta Potential in Colloid Science: Principle and Applications*. Academic Press, London.
- Huson, M.G., 1992. The mechanism by which oxidizing agents minimize strength losses in wool dyeing. *Text. Res. J.* 62, 9–14.
- Hyde, N., 1988. 'Fabric of History – Wool', *National Geographic*, vol. 173. National Geographic Society, Washington DC, pp. 552–591.
- Ichimura, H., Umehara, R., Karakawa, T., Oshima, K., Nakase, K., July, 2001. 'Shrinkproof Animal Fiber and Method for Preparation Thereof', European Patent 1176245 A1.
- Ingham, P.E., McNeil, S.J., Sutherland, M.R., 2012. Fundamental finishes for wool-Eco considerations. *Adv. Mater. Res.* 44, 33–43.

- Inoue, S., Tanaka, K., Arisaka, F., Kimura, S., Ohtomo, K., Mizuno, S., 2000. Silk fibroin of *Bombyx Mori* is secreted, assembling a high molecular mass elementary unit consisting of H-chain, L-chain, and P25, with a 6:6:1 molar ratio. *J. Biol. Chem.* 275, 40517–40528.
- Jang, J., Ko, S.W., Carr, C.M., 2001. Investigation of the improved dyeability of cationised cotton via photografting with UV active cationic monomers. *Color. Technol.* 117, 139–146.
- Jones, F.W., 1973. Wool-polymer systems: the effect of elastomers on the wrinkle recovery of wool. *J. Text. Inst.* 64, 263–272.
- Jones, F.W., Leeder, J.D., 1974a. The wrinkling behaviour of wool fabrics: the effect of metal salts on dry and wet wrinkle recovery. *J. Text. Inst.* 65, 374–379.
- Jones, F.W., Leeder, J.D., 1974b. Wool-polymer systems: the effect of internal deposition of polymers on the wrinkle recovery of wool. *J. Text. Inst.* 65, 627–631.
- Jones, F.W., Leeder, J.D., Wemyss, A.M., 1972. The wrinkling behaviour of wool fabrics: the effect of annealing and cross-linking. *J. Text. Inst.* 63, 135–141.
- Jones, F.W., Leeder, J.D., Wemyss, A.M., 1973. The wrinkling behaviour of wool fabrics: the effect of formaldehyde condensation polymers on the stabilisation of annealed wool. *J. Text. Inst.* 64, 587–593.
- Jones, L.N., 1976. Studies on microfibrils from α -keratin. *Biochim. Biophys. Acta* 446, 515–524.
- Jones, L.N., Rivett, D.E., Tucker, D.J., 1998. Wool and related mammalian fibers. In: Lewin, M., Pearce, E.M. (Eds.), *Handbook of Fiber Chemistry*. Marcel Dekker, New York, pp. 355–413.
- Kawahara, Y., 1993. Analysis for the void structure of silk fibers by tin-weighting. *Seni Gakkai Shi* 49, 621–627.
- Kennedy, J.F., White, C.A., 1988. The plant, algal, and microbial polysaccharides. In: Kennedy, J.F. (Ed.), *Carbohydrate Chemistry*. Oxford University Press, Oxford, pp. 220–261.
- Kershaw, A., Lewis, J., 1976. The role of polymer treatments in the shrinkproofing of wool. *Textile Month.* April, 40–44.
- Kilpatrick, D.J., Rippon, J.A., Rushforth, M.A., Shaw, T., 1977. Shrink-resist polymers for wool: a comparative study. In: Arthur, J.C. (Ed.), *Textile and Paper Chemistry and Technology*. American Chemical Society, Washington DC, pp. 176–196.
- King, A.T., 1927. Unscaled fibres: a new aspect of fibre research. *Biochem. J.* 21, 434–436.
- King, D.G., 2007. Dyeing of cotton and cotton products. In: Gordon, S., Hsieh, Y.-L. (Eds.), *Cotton Science and Technology*. Woodhead Publishing, Cambridge, pp. 353–377.
- Klausen, T., Thomas, H., Höcker, H., 1995. Influence of oxygen plasma treatment on the chemical and morphological changes of the wool fibre surface. In: *Proceedings of the 9th International Wool Textile Research Conference*, vol. 2. Cita' degli studi biella, Biella, Italy, pp. 241–248.
- Komatsu, K., 1979. Chemistry and structure of silk. *Jpn. Agric. Res. Q.* 13, 64–72.
- Lambrinou, I., 1975. In: 'Linen and Alkali Part I', *Melliand Textilberichte International Textile Reports (English Edition)*, vol. 4, pp. 255–257. 'Linen and alkali Part II', *Melliand Textilberichte International Textile Reports (English Edition)*, 4, 737–744.
- Latham, F.R., 1995. Dyeing with vat dyes. In: Shore, J. (Ed.), *Cellulosics Dyeing*. Society of Dyers and Colourists, Bradford, UK, pp. 246–279.
- Leeder, J.D., 1986. The cell membrane complex and its influence on the properties of the wool fibre. *Wool Sci. Rev.* 63. Ilkley, UK: International Wool Secretariat, 3–35.
- Leeder, J.D., Marshall, R.C., 1982. Readily extracted proteins from merino wool. *Text. Res. J.* 52, 245–249.

- Leeder, J.D., Rippon, J.A., 1983. Some observations on the dyeing of wool from aqueous formic acid. *J. Soc. Dye. Colour.* 99, 64–65.
- Leeder, J.D., Rippon, J.A., 1985. Changes induced in the properties of wool by specific epicuticle modification. *J. Soc. Dye. Colour.* 101, 11–16.
- Leeder, J.D., Rippon, J.A., Rivett, D.E., 1985a. Modification of the surface properties of wool by treatment with anhydrous alkali. In: *Proceedings of the 7th International Wool Textile Research Conference*, vol. 4. Society of Fiber Science and Technology, Japan, Tokyo, pp. 312–321.
- Leeder, J.D., Holt, L.A., Rippon, J.A., Stapleton, I.W., 1990. Diffusion of dyes and other reagents into wool fibres. In: *Proceedings of the 8th International Wool Textile Research Conference*, vol. 4. Wool Research Organisation of New Zealand, Christchurch, pp. 227–238.
- Leeder, J.D., Rippon, J.A., Rothery, F.E., Stapleton, I.W., 1985b. Use of the transmission electron microscope to study dyeing and diffusion processes. In: *Proceedings of the 7th International Wool Textile Research Conference*, vol. 5. Society of Fiber Science and Technology, Japan, Tokyo, pp. 99–108.
- Lei, X.P., Lewis, D.M., 1991. The dyeing behaviour of cotton modified with chloropropionyl chloride and related compounds. *Dyes Pigments* 16, 273–289.
- Levene, R., Shakkour, G., 1995. Wool fibres of enhanced lustre obtained by enzymatic descaling. *J. Soc. Dye. Colour.* 111, 352–359.
- Lewin, M., Roldan, L.G., 1971. The effect of liquid ammonia in the structure and morphology of cotton cellulose. *J. Polym. Sci. Polym. Chem. Ed.* 36, 213–229.
- Lewis, D.M., 1977a. ‘The Dyeing of Wool with Pre-metallised Dyes – with Particular Reference to Recent Developments’, *Wool Science Review*, 54. International Wool Secretariat, Ilkley, UK, pp. 30–45.
- Lewis, D.M., 1989. Damage in wool dyeing. *Rev. Prog. Coloration* 19, 49–56.
- Lewis, D.M., 2008. The coloration of wool. In: Johnson, N.A., Russell, I.M. (Eds.), *Advances in Wool Technology*. Woodhead Publishing, Cambridge, UK, pp. 183–213.
- Lewis, D.M., 2013a. Ancillary processes in wool dyeing. In: Lewis, D.M., Rippon, J.A. (Eds.), *The Coloration of Wool and Other Keratin Fibres*. Society of Dyers and Colourists, Bradford, UK, pp. 98–129.
- Lewis, D.M., 2013b. Dyeing wool with reactive dyes. In: Lewis, D.M., Rippon, J.A. (Eds.), *The Coloration of Wool and Other Keratin Fibres*. Society of Dyers and Colourists, Bradford, UK, pp. 251–290.
- Lewis, D.M., McIlroy, K.A., 1997. The chemical modification of cellulosic fibres to enhance dyeability. *Rev. Prog. Coloration* 27, 5–17.
- Lewis, D.M., Rippon, J.A. (Eds.), 2013. *The Coloration of Wool and Other Keratin Fibres*. Society of Dyers and Colourists, Bradford, UK.
- Lewis, D.M., Smith, S.M., 1990. Reactive dyes and wool damage. In: *Proceedings of the 8th International Wool Textile Research Conference*, vol. 4. Wool Research Organisation of New Zealand, Christchurch, pp. 177–186.
- Lewis, J., 1977b. ‘A Review of Superwash Technology’, *Wool Science Review*, 54. International Wool Secretariat, Ilkley, UK, pp. 2–29.
- Lewis, J., 1978. ‘Continuous Shrink-Proofing Processes’, *Wool Science Review*, 55. International Wool Secretariat, Ilkley, UK, pp. 23–42.
- Lindley, H., 1977. The chemical composition and structure of wool. In: Asquith, R.S. (Ed.), *Chemistry of Natural Protein Fibres*. Plenum Press, New York, pp. 147–191.
- Lipson, M., 1947. Unshrinkable wools produced by alcoholic alkali. *J. Text. Inst.* 38, 279–285.

- Lord, E., 1961. *Manual of Cotton Spinning*, Vol. 2, Part 1. Textile Institute and Butterworths, Manchester and London.
- Lower, E.S., August 9–14, 1988. Silk: its properties and main end uses. *Textile Month*.
- Lucas, F., Shaw, J.T.B., Smith, S.G., 1958. The silk fibroins. *Adv. Protein Chem.* 13, 107–242.
- Lucas, F., Rudall, K.M., 1968. Intracellular fibrous proteins and the keratins. In: Florkin, M., Stotz, E.H. (Eds.), *Comprehensive Biochemistry*, vol. 26. Elsevier, Amsterdam, pp. 475–558.
- Maclaren, J.A., Milligan, B., 1981. *Wool Science: The Chemical Reactivity of the Wool Fibre*. Science Press, NSW, Australia.
- Makinson, K.R., 1967. The use of a diffraction grating as a rubbing surface in the study of the frictional properties of wool fibers. *Text. Res. J.* 37, 763–771.
- Makinson, K.R., 1974. The role of chlorination in oxidative antifelting treatments of wool. *Text. Res. J.* 44, 856–857.
- Makinson, K.R., 1975. Mechanism of shrink-proofing with silicone resins. *Text. Res. J.* 45, 217–219.
- Makinson, K.R., 1979. *Shrinkproofing of Wool*. Marcel Dekker, New York.
- Makinson, K.R., Lead, J.A., 1973. The nature and function of the resin in the chlorine/resin shrink-proofing treatment of wool tops. *Text. Res. J.* 43, 669–681.
- Marsh, J.T., 1941. *Mercerising*. Chapman and Hall, London.
- Marshall, W.J., Peters, R.H., 1947. The heats of reaction and affinities of direct cotton dyes for cuprammonium rayon, viscose rayon and cotton. *J. Soc. Dye. Colour.* 63, 446–461.
- McCleary, H.R., 1953. Fundamentals of the dyeing of cellulosic fibers. *Text. Res. J.* 23, 673–682.
- McGovern, J.N., 1990. ‘Vegetable Fibers’, in *Polymers – Fibers and Textiles, a Compendium*. University of Wisconsin Press, Madison, WI, pp. 412–430.
- McPhee, J.R., 1960. Reaction of wool with oxidizing agents in concentrated salt solutions. *Text. Res. J.* 30, 349–357.
- McPhee, J.R., 1963. Shrinkproofing of wool with peracetic acid followed by sodium sulfite. *Text. Res. J.* 33, 755–757.
- McPhee, J.R., 1971. *The Mothproofing of Wool*. Merrow Publishing, Watford.
- Mercer, E.H., 1954. The relation between external shape and internal structure of wool fibers. *Text. Res. J.* 24, 39–43.
- Merten, T., Thomas, H., Höcker, H., 1995. Comparative investigations on the shrinkage behaviour of corona and glow discharge-treated wool top. In: *Proceedings of the 9th International Wool Textile Research Conference*, vol. 4. Cita’ degli studi biella, Biella, Italy, pp. 386–393.
- Meybeck, J., Galafassi, P., 1970. The effect of hydrocarbon substituents in azo dyes on wool. In: *Proceedings of the 4th International Wool Research Conference, Applied Polymer Symposia*, No. 18, Part 1. San Francisco, pp. 463–472.
- Meybeck, A., Meybeck, J., 1967. Photooxidation of the peptide group I, fibrous proteins. *Photochem. Photobiol.* 6, 355–363.
- Millard, M.M., 1975. Surface analysis of plasma-treated wool fibers by X-ray photoelectron spectrometry. In: *Proceedings of the 5th International Wool Textile Research Conference, Aachen*, vol. 2. Deutsches Wollforschungsinstitut, pp. 44–53.
- Millington, K.R., 2006a. ‘Photoyellowing of Wool. Part I: Factors Affecting Photoyellowing and Experimental Techniques’, *Coloration Technology*, vol. 122, pp. 169–186. Part II: ‘Photoyellowing mechanisms and methods of prevention’, *Coloration Technology*, 122, 301–316.

- Millington, K.M., 2006b. Improving the photostability of whitened wool by applying an anti-oxidant and a metal chelator rinse. *Color. Technol.* 122, 49–56.
- Millington, K.R., Kirschenbaum, L.J., 2002. Detection of Hydroxyl radicals in photoirradiated wool, cotton, nylon and polyester fabric using a fluorescent probe. *Color. Technol.* 118, 6–14.
- Mills, W., 2007. 'Beating moths the clean way'. *Wool. Rec.* 166–230.
- Mitchell, T.W., Feughelman, M., 1967. The mechanical properties of wool fibers in water at temperatures above 100°C. *Text. Res. J.* 37, 660–668.
- Moncrieff, R.W., 1953. *Wool Shrinkage and its Prevention*. National Trades Press, London.
- Müller, B.M., 1992. Adsorbable organic halogens in textile effluents. *Rev. Prog. Coloration* 22, 14–21.
- Naebe, M., Cookson, P.G., Rippon, J.A., Wang, X., 2010a. Effect of leveling agent on the uptake of reactive dyes by untreated and plasma-treated wool. *Text. Res. J.* 80, 611–622.
- Naebe, M., Cookson, P.G., Rippon, J.A., Brady, R.P., Wang, X., Brack, N., van Riessen, G., 2010b. Effects of plasma treatment of wool on the uptake of sulfonated dyes with different hydrophobic properties. *Text. Res. J.* 80, 312–324.
- Nakpathom, M., Somboon, B., Narumol, N., 2009. Papain enzymatic degumming of Thai *Bombyx mori* silk fibers. *J. Microsc. Soc. Thailand* 23, 142–146.
- Negri, A.P., Cornell, H.J., Rivett, D.E., 1992. Effects of processing on the bound and free fatty acid levels in wool. *Text. Res. J.* 62, 381–387.
- Nevell, T.P., 1995. Cellulose structure, properties and behaviour in the dyeing process. In: Shore, J. (Ed.), *Cellulosics Dyeing*. Society of Dyers and Colourists, Bradford, UK, pp. 1–80.
- Nevell, T.P., Zeronian, S.H., 1985. *Cellulose Chemistry and its Applications*. Ellis Horewood, Chichester.
- Orwin, D.F.G., 1979. Cytological studies of keratin fibres. In: Parry, D.A.D., Creamer, L.K. (Eds.), *Fibrous Proteins: Scientific, Industrial and Medical Aspects*, vol. 1. Academic Press, London, pp. 271–297.
- Peters, R.H., 1967. 'Mercerisation of Cotton', in *Textile Chemistry, Vol. II: Impurities in Fibres: Purification of Fibres*. Elsevier, London, pp. 328–365.
- Peters, R.H., 1975. 'Adsorption of Direct Dyes by Cellulose', in *Textile Chemistry, Vol III: The Physical Chemistry of Dyeing*. Elsevier, New York, pp. 379–472.
- Pierlot, A.P., 1997. Influence of glass transition temperature on the felting shrinkage of wool fabric. *Text. Res. J.* 67, 616–618.
- Ponchel, P., Bauters, M., 1975. 'Spécificité des modifications de la cuticule sous l'effet de certains agents'. In: *Proceedings of the 5th International Wool Textile Research Conference*, Aachen, vol. 3. Deutsches Wollforschungsinstitut, pp. 213–223.
- Postle, L.J., Ingham, J., 1952. The measurement of inter-fibre friction in slivers. *J. Text. Inst.* 43, T77–T90.
- Powning, R.F., Irzykiewicz, H., 1962. Digestive proteinase of clothes moth larvae, II, Digestion of wool and other substrates by *Tineola* proteinase and comparison with trypsin. *J. Insect Physiol.* 8, 275–284.
- Rakowski, W., 1990. 'Plasma treatment of wool – from lab curiosity to industrial reality'. In: *Proceedings of the 9th International Wool Textile Research Conference*, Biella, Italy, vol. 4. Cita' deglia studi biella, pp. 359–368.
- Rattee, I.D., 1984. 'Reactive dyes for cellulose 1953–1983'. *Rev. Prog. Coloration* 14, 50–57.
- Rearick, W.A., Wallace, M.L., Martin, V.B., February 2002. Flammability considerations for raised-surface apparel. *AATCC Rev.* 2, 12–15.

- Rigby, B.J., Mitchell, T.W., 1972. Ageing in single wool fibres. *J. Text. Inst.* 63, 416–421.
- Rippon, J.A., 1984. Improving the dye coverage of immature cotton fibres by treatment with chitosan. *J. Soc. Dye. Colour.* 100, 298–303.
- Rippon, J.A., 2008. Friction, felting and shrinkproofing of wool. In: Gupta, B.S. (Ed.), *Friction in Textile Materials*. Woodhead Publishing, Cambridge, pp. 253–291.
- Rippon, J.A., 2013a. The structure of wool. In: Lewis, D.M., Rippon, J.A. (Eds.), *The Coloration of Wool and Other Keratin Fibres*. Society of Dyers and Colourists, Bradford, UK, pp. 1–42.
- Rippon, J.A., 2013b. The chemical and physical basis for wool dyeing. In: Lewis, D.M., Rippon, J.A. (Eds.), *The Coloration of Wool and Other Keratin Fibres*. Society of Dyers and Colourists, Bradford, UK, pp. 43–74.
- Rippon, J.A., Harrigan, F.J., 1994. Dyeing Process for Keratin Materials, with Improved Exhaustion of Bath Constituents. US Patent, p. 5496379.
- Rippon, J.A., Leeder, J.D., 1986. The effect of treatment with perchloroethylene on the abrasion resistance of wool fabric. *J. Soc. Dye. Colour.* 102, 171–176.
- Rippon, J.A., Rushforth, M.A., 1976. The use of the water-soluble bisulphite addition product of a polyisocyanate. *Textilveredlung* 11, 224–229.
- Rippon, J.A., Harrigan, F.J., Tilson, A.R., 1995. The Sirolan-LTD wool dyeing process: improved product quality with economic benefits and cleaner effluent. In: *Proceedings of the 9th International Wool Textile Research Conference*, vol. 3. Cita' degli studi biella, Biella, Italy, pp. 122–131.
- Rippon, J.A., Christoe, J.R., Denning, R.J., Evans, D.J., Huson, M.G., Lamb, P.R., Millington, K.R., Pierlot, A.P., 2016. Wool: structure, properties and processing. In: *Encyclopedia of Polymer Science and Technology*. John Wiley, New York. April 2019. <https://onlinelibrary.wiley.com/doi/10.1002/0471440264.pst402.pub2>.
- Rivett, D.E., 1991. 'Structural Lipids of the Wool Fibre', *Wool Science Review*, 67. International Wool Secretariat, Ilkley, UK, pp. 1–25.
- Robson, R.M., 1998. Silk composition, structure and properties. In: Lewin, M., Pearce, E.M. (Eds.), *Handbook of Fibre Chemistry*, second ed. Marcel Dekker, New York, pp. 415–463.
- Rowell, R.M., Stout, H.P., 1998. Jute and kenaf. In: Lewis, M., Pearce, E.M. (Eds.), *Handbook of Fibre Chemistry*, second ed. Marcel Dekker, New York, pp. 465–504.
- Rowland, S.P., Wade, C.P., Bertoniere, N.R., 1984. Pore structure analysis of purified, sodium hydroxide-treated and liquid ammonia-treated cotton celluloses. *J. Appl. Polym. Sci.* 29, 3349–3357.
- Rudall, K.M., 1962. Silk and other cocoon proteins. In: Florkin, M., Mason, H.S. (Eds.), *Comparative Biochemistry*. Academic Press, New York, pp. 397–433.
- Rupin, M., 1976. Dyeing with direct and fiber reactive dyes. *Text. Chem. Colorist* 8, 139–143.
- Russell, I.M., Pierlot, A.P., 1999. Chemically Assisted Protein Annealing Treatment. USP 5928383.
- Ryder, M.L., 1987. 'The Evolution of the Fleece', *Scientific American* (Jan.). Scientific American Inc., New York, pp. 100–107.
- Sandoz Technical Bulletin, 1971. Multicolour Effects on Wool, No. 1570. Basle, Switzerland.
- Sandoz Technical Information, 1987. Sandospace DPE Liquid, vol. 8. Basle, Switzerland.
- Schindler, W.D., Hauser, P.J., 2004. *Chemical Finishing of Textiles*. Woodhead Publishing, Cambridge, pp. 51–73.
- Schumacher-Hamedat, U., Laurini, C., Schneider, V., 1990. The chemistry and physics of the wool surface upon shrink-proofing. In: *Proceedings of the 8th International Wool Textile Research Conference*, Christchurch, vol. 4. Wool Research Organisation of New Zealand, pp. 451–460.

- Senior, C., 1995. Dyeing with sulphur dyes. In: Shore, J. (Ed.), *Cellulosics Dyeing*. Society of Dyers and Colourists, Bradford, UK, pp. 280–320.
- Service, R.F., 2017. Spinning Spider Silk into Startup Gold. *Science Magazine*, American Association for the Advancement of Science. <http://www.sciencemag.org/news/2017/10/spinning-spider-silk-startup-gold>.
- Shank, D., March 2002. Non formaldehyde wrinkle-free finishing: a commercial update. *AATCC Rev.* 2 (3), 29–32.
- Shore, J., 1995a. Dyeing with direct dyes. In: Shore, J. (Ed.), *Cellulosics Dyeing*. Society of Dyers and Colourists, Bradford, UK, pp. 1–80.
- Shore, J., 1995b. Dyeing with reactive dyes. In: Shore, J. (Ed.), *Cellulosics Dyeing*. Society of Dyers and Colourists, Bradford, UK, pp. 189–245.
- Shore, J., 1995c. Dyeing with azoic components. In: Shore, J. (Ed.), *Cellulosics Dyeing*. Society of Dyers and Colourists, Bradford, UK, pp. 321–351.
- Simpson, W.S., 1971. 'Polymer Deposition in Wool', IWS Product Development Report, No. 143, Parts I and II.
- Simpson, W.S., 2002a. Chemical processes for enhanced appearance and performance. In: Simpson, W.S., Crawshaw, G.H. (Eds.), *Wool: Science and Technology*. Woodhead Publishing Limited, Cambridge, pp. 230–231.
- Simpson, W.S., 2002b. Chemical processes for enhanced appearance and performance. In: Simpson, W.S., Crawshaw, G.H. (Eds.), *Wool: Science and Technology*. Woodhead Publishing, Cambridge, UK, pp. 217–219.
- Sloan, F.R.W., 1974. Preparation, bleaching, dyeing and finishing of linen. *Rev. Prog. Coloration* 5, 12–16.
- Speakman, J.B., Stott, E., 1931. A contribution to the theory of milling: a method of measuring the scaliness of wool. *J. Text. Inst.* 22, T339–T348.
- Speakman, J.B., Whewell, E., 1945. The use of abrasives to make wool unshrinkable. *J. Text. Inst.* 36, T48–T56.
- Speakman, J.B., Stott, E., Chang, H., 1933. A contribution to the theory of milling. *J. Text. Inst.* 24, T273–T292.
- Speakman, J.B., Nilssen, B., Elliott, G.H., 1938. Reactivity of the sulphur linkage in wool. *Nature* 142, 1035.
- Stewart, R.G., 1985. *Wool Scouring and Allied Technology*, second ed. Wool Research Organization of New Zealand, New Zealand.
- Sutherland, T.D., Young, J.H., Weisman, S., Hayashi, C.Y., Merritt, D.J., 2010. Insect silk: one name, many materials. *Annu. Rev. Entomol.* 55, 171–188.
- Swift, J.A., 1977. The histology of keratin fibers. In: Asquith, R.S. (Ed.), *Chemistry of Natural Protein Fibres*. Plenum Press, New York, pp. 81–146.
- Tanaka, K., Kajiyama, N., Ishikura, K., Waga, S., Kikuchi, A., Ohtomo, K., Takagi, T., Mizuno, S., 1999. Determination of the site of disulfide linkage between heavy and light chains of silk fibroin produced by *Bombyx mori*. *Biochim. Biophys. Acta* 1432, 92–103.
- Taylor, D.S., 1973. The wrinkling behaviour of wool fabrics: the effect of annealing parameters. *J. Text. Inst.* 64, 405–411.
- Teasedale, D.C., 1988. *Wool Testing and Marketing Handbook*. University of New South Wales, Australia.
- Tester, D.H., 1984. Fracture planes of fibers from Martindale abraded wool fibers. *Text. Res. J.* 54, 75–76.
- Thomas, H., 2007. Plasma modification of wool. In: Shishoo, R. (Ed.), *Plasma Technologies for Textiles*. Woodhead Publishing, Cambridge, UK, pp. 228–246.

- Thorsen, W.J., 1971. Improvements in cotton spinnability, strength and abrasion resistance by corona treatment. *Text. Res. J.* 41, 455–458.
- Thorsen, W.J., Kodani, R.Y., 1966. A corona discharge method of producing shrink-resistant wool and mohair. *Text. Res. J.* 36, 651–661.
- Thorsen, W.J., Ward, W.H., Millard, M.M., 1979. Wool shrinkage control and surface modification by ozone. *J. Appl. Polym. Sci.* 24, 523–546.
- Townend, F., 1945. Two-colour dyeing of all-wool materials. *J. Soc. Dye. Colour.* 61, 144–150.
- Truter, E.V., 1956. *Wool Wax*. Cleaver-Hume Press, London.
- Tsukada, M., Nagura, M., Ishikawa, H., Shiozak, H., 1991. Structural characteristics of silk fabrics treated with epoxides. *J. Appl. Polym. Sci.* 43, 643–649.
- Tsukada, M., Shiozaki, H., Goto, Y., Freddi, G., 1993. Physical properties of silk fabrics treated with ethyleneglycol diglycidyl ether by the pad/batch method. *J. Appl. Polym. Sci.* 50, 1841–1849.
- Turner, A.J., 1920. Influence of atmospheric exposure on the properties of textiles. *J. Soc. Dye. Colour.* 36, 165–173.
- Turner, A.J., 1953. The structure of textile fibers. In: Urquhart, A.R., Howitt, F.O. (Eds.). *Textile Institute*, Manchester, pp. 91–117.
- Vickerstaff, T., 1954. *The Physical Chemistry of Dyeing*. Oliver and Boyd, London.
- von Bergen, W., 1970, third ed. *Wool Handbook*, Vol. 2, Part 2. Interscience, New York.
- Vreeland, J.M., 1999. The revival of colored cotton. *Sci. Am.* 280 (4), 112–118.
- Wakelyn, P.J., Bertoniere, N.R., French, A.D., Thibodeaux, D.P., Triplett, B.A., Rouselle, M.-A., Goynes Jr., W.R., Edwards, J.V., Hunter, L., McAlister, D.D., Gamble, G.R., 2007a. Structural properties of cotton. In: *Cotton Fiber Chemistry and Technology*. CRC Press, Boca Raton, FL, pp. 23–67.
- Wakelyn, P.J., Bertoniere, N.R., French, A.D., Thibodeaux, D.P., Triplett, B.A., Rouselle, M.-A., Goynes Jr., W. R., Edwards, J.V., Hunter, L., McAlister, D.D., Gamble, G.R., 2007b. Chemical properties of cotton. In: *Cotton Fiber Chemistry and Technology*. CRC Press, Boca Raton, FL, pp. 69–106.
- Wang, H., Lewis, D.M., 2002. Chemical modification of cotton to improve fibre dyeability. *Color. Technol.* 118, 159–168.
- Ward, R.J., Willis, H.A., George, G.A., Guise, G.B., Denning, R.J., Evans, D.J., Short, R.D., 1993. Surface analysis of wool by X-ray photoelectron spectroscopy and static secondary ion mass spectrometry. *Text. Res. J.* 63, 362–368.
- Wei, M., Zhang, S., Tang, B., Yang, J., 2005. Pretreatment of cotton with poly(vinylamine chloride) for salt-free dyeing with reactive dyes. *Color. Technol.* 121, 193–197.
- Welch, C.M., Peters, J.G., 1997. Mixed polycarboxylic acids and mixed catalyst in formaldehyde-free durable press finishing. *Text. Chem. Colorist* 29, 22–27.
- Wick, C.B., 1995. Genencor international takes a green route to blue dye. *Genet. Eng. News* 15, 22–25.
- Wojciechowska, E., Pielesz, A., Wlochowicz, A.Z., 1991. ‘Yellowing of wool – reasons’. In: *Proceedings of the 5th International Wool Textile Research Conference*, Metlan. Gdynia, Poland, pp. 21–26.
- Wolfgang, W.G., 1970. Silk. In: Mark, H., Gaylord, N. (Eds.), *Encyclopaedia of Polymer Science and Technology*, vol. 12. Interscience, New York, pp. 578–585.
- Wortmann, F.J., Rigby, B.J., Phillips, D.G., 1984. Glass transition temperature of wool as a function of regain. *Text. Res. J.* 54, 6–8.
- Yang, Y., Li, S., 1992. Crease-proofing silk. *Text. Asia* 23, 72–75.
- Yang, Y., Li, S., 1994. Crease resistant finishing of silk fabric with BTCA. *Text. Chem. Colorist* 26 (5), 25–29.

- Young, R.A., 1997. Fibres (vegetable). In: Howe-Grant, M. (Ed.), *Kirk-Othmer Encyclopaedia of Chemical Technology*, vol. 10. Wiley-Interscience, New York, pp. 727–744.
- Youssef, Y.A., Mousa, A.A., Farouk, R., 2009. High performance reactive disperse dye-fixation on silk fabric. *AATCC Rev.* 9, 33–39.
- Zahn, H., 1980. 'Wool is not keratin only', Plenary Lecture. In: *Proceedings of the 6th International Wool Textile Research Conference*, Pretoria, South Africa, Addendum to Vol. I. South African Wool and Textile Research Institute, Pretoria, pp. 1–15.
- Zahn, H., Blankenburg, G., 1964. Action of alcohol/water mixtures on wool. *Text. Res. J.* 34, 176–177.
- Zahn, H., Kusch, P., 1981. Wool as a biological composite system. *Melliand Textilberichte Int. Text. Rep. (English edn.)* 10, 75–85.
- Zeronian, S.H., 1985. Intercrystalline swelling of cellulose. In: Nevell, T.P., Zeronian, S.H. (Eds.), *Cellulose Chemistry and its Applications*. Ellis Horwood, Chichester, pp. 159–180.
- Ziegler, K., 1965. The influence of alkali treatment on wool. In: *Proceedings of the 3rd International Wool Textile Research Conference*, Paris, vol. 2, pp. 403–417.
- Ziegler, K., 1977. Crosslinking and self-crosslinking in keratin fibers. In: Asquith, R.S. (Ed.), *Chemistry of Natural Protein Fibers*. Plenum Press, New York, pp. 267–300.

This page intentionally left blank

Electrokinetic properties of natural fibres

9

Thomas Luxbacher

Anton Paar GmbH, Graz, Austria

9.1 Introduction

Many technical and biological processes are driven by the electrostatic interaction between a solid surface and dissolved components in a surrounding liquid phase. The charging characteristic at the solid–liquid interface determines the type and strength of the electrostatic interaction. Knowledge of the solid surface charge is therefore of great importance for the understanding, control and optimization of these processes. The treatment of natural fibres for textile application, for the reinforcement of composite materials, or for biomedical use aims primarily at the introduction of specific surface functionalities, which alter the charging behaviour of a fibre material. The success of a surface modification process may be determined by the measurement of surface charge. Unfortunately, several factors disable the direct analysis of the surface charge. The functional groups become charged only in contact with the liquid and the number and even the sign of these charges are strongly dependent on the pH value of an aqueous solution. A titration method commonly used for the determination of surface charge on particles in suspension (Wäsche et al., 2002) is not applicable for fibre characterization. Firstly, the size of fibres is too large to obtain a stable dispersion. Secondly, the auxiliary chemicals used for charge titration change conductivity and pH of the aqueous solution and thus alter the fibre surface charge. However, surface charge is related to the surface potential (Hunter, 1981), which again cannot be determined by direct means. The electrokinetic or zeta potential has been accepted as an approximation for the surface potential and thus for the surface charge of a solid.

Section 9.2 explains the physical background of electrokinetic effects and discusses the type and principles of methods for the measurement of these phenomena. Focus is thereby on the streaming potential method. The electrokinetic effects are related to the interfacial zeta potential. Its relation to surface charge and related phenomena is discussed.

In Section 9.3 studies of electrokinetic properties of natural fibres in the literature are reviewed. The major properties and applications of natural fibres characterized by their electrokinetic behaviour are discussed. The properties comprise the effect of swelling on the zeta potential, the kinetics of swelling, and the correlation with water uptake capability. The application of cellulose fibres for textiles is discussed, including the processing of cotton and regenerated cellulose fibres with respect to the accessibility of surface functional groups. The idea of using natural fibres as a source for reinforcing composite materials is mentioned with focus on the role of

coupling and grafted agents. The section concludes with a brief review of the analysis of electrokinetic properties of human hair as another type of natural fibre.

An extension of the possibilities of the electrokinetic characterization of natural fibres is suggested in [Section 9.4](#). The range of applications of natural fibres in functional textiles (e.g. fixation of microencapsulated compounds) and biomedicine (e.g. nonwovens of natural fibres for wound healing) are also discussed.

9.2 Key principles of electrokinetic properties of natural fibres

The current knowledge of electrokinetics has been reviewed a couple of years ago by a working group within the International Union of Pure and Applied Chemistry ([Delgado et al., 2005](#)). The basic principle leading to the observation of electrokinetic phenomena is the movement of a liquid phase relative to a charged solid surface. In microelectrophoresis, charged particles dispersed in a liquid move under the influence of an electric field. The measured electrophoretic mobility of these particles is related to their electrokinetic or zeta potential and furthermore to the electrokinetic charge density. The sedimentation of charged particles in a liquid either driven by gravity or accelerated by centrifugal force gives rise to the sedimentation potential. For macroscopic solids, the streaming potential and alternatively the streaming current are generated either by flowing liquid tangential to a flat solid surface or by forcing the liquid through a permeable sample, for example, a fibre plug, powder bed or porous filter. A pressure gradient applied between both ends of the capillary system composed of the solid material is the driving force for the streaming potential and current. For permeable samples, the electro-osmotic flow of liquid caused by an electric field is another phenomenon giving the zeta potential of the corresponding solid surface. The colloid vibration current ([Dispersion Technology, Inc., 2018](#)) or the electrokinetic sonic amplitude ([Colloidal Dynamics, LLC, 2018](#)) for the electroacoustic determination of the zeta potential of colloidal particles complete the series of major electrokinetic effects. A schematic representation of the principles of these electrokinetic phenomena is given in [Fig. 9.1](#).

Natural fibres occur in a size range, which makes them unsuitable for the zeta potential measurement by electrophoresis or sedimentation potential. Mainly the length but also the diameter of the fibres exceeds the upper limits for obtaining a stable dispersion in a liquid phase. Although electroacoustics enables the analysis of particles with larger size, the little difference in density between fibres and the solvent constrains the application of this technique especially in aqueous solution, where fibre swelling reduces the difference in density compared to water even further.

The zeta potential of fibres, which are randomly arranged to form a permeable sample plug, may be assessed by the measurement of the electro-osmotic flow. [Jacobasch et al. \(1985\)](#) reviewed the zeta potential calculated from the measurement of electro-osmotic flow and compared this electrokinetic approach with the measurement of streaming current and streaming potential. Although a commercial apparatus was

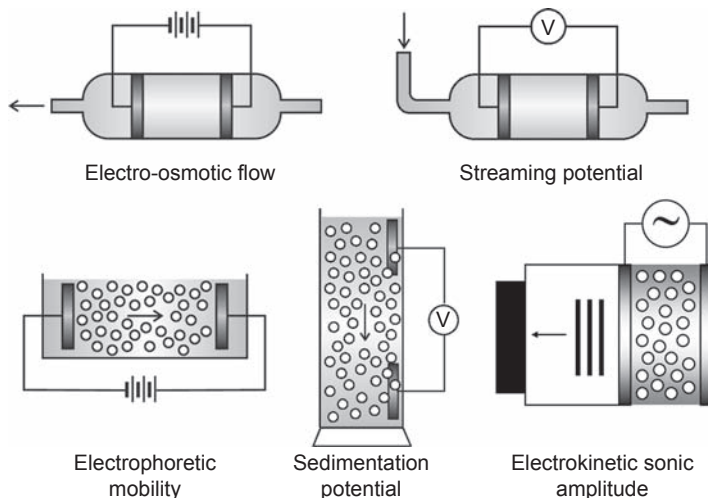

Figure 9.1 Schematic representation of the measuring principles of the electrokinetic phenomena electro-osmotic flow, streaming potential, electrophoretic mobility, sedimentation potential, and electrokinetic sonic amplitude.

not available for either streaming potential/current measurement or for the determination of electro-osmotic flow, the review recommended the use of streaming potential/current measurement for the zeta potential determination of fibres. Primarily the easier and more precise determination of electrical quantities (voltage, current) compared to the marginal volume flow rate, the significantly shorter measuring time for streaming potential/current, and the need for correction of volume backflow in case of electro-osmosis were decisive for the preference of the streaming potential/current method for the zeta potential determination of fibre samples.

9.2.1 Theoretical background

The concept of zeta potential is based on the fundamental model of the electrochemical double layer (EDL) shown in Fig. 9.2 (Hunter, 2001). In contact with an aqueous solution, a solid surface assumes a surface charge. The charged solid surface provokes an interfacial charge distribution that is different from the charge distribution in the liquid phase. The surface charge further gives rise to a surface potential, which decays with increasing distance from the solid surface. The EDL model distinguishes between a stationary immobile and a diffuse mobile layer of counter-ions that compensate the surface charge. For the sake of simplicity we neglect the extension of the Stern model of the EDL, which describes a sub-structure of the stationary layer (Hunter, 2001). Common to all models is the existence of an electrokinetic or zeta potential at the boundary between the stationary and diffuse layers of counter-ions, which is accessible experimentally by measuring any of the electrokinetic effects described in Section 9.2 appropriate for the solid sample. The boundary is known as the shear plane and

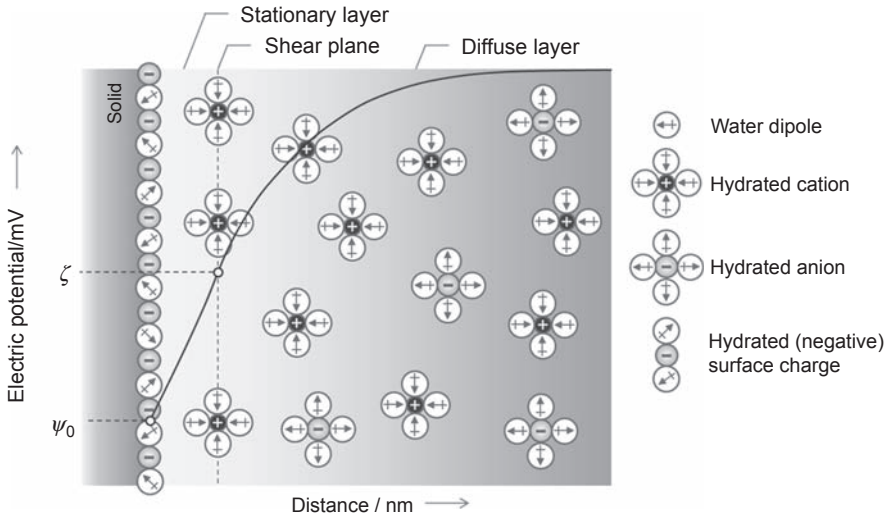

Figure 9.2 Model of the electrochemical double layer.

indicates the location of slipping of the moving phase relative to the stationary phase during the electrokinetic measurement. The location of the solid surface is responsible for the zeta potential being an interfacial property and thus depending on both the surface potential (surface charge) and the properties of the liquid.

Fig. 9.3 shows schematically the generation of the streaming current and streaming potential signals. In contact with a liquid phase, a solid surface exhibits a surface charge. In aqueous solution the surface charge originates primarily from the

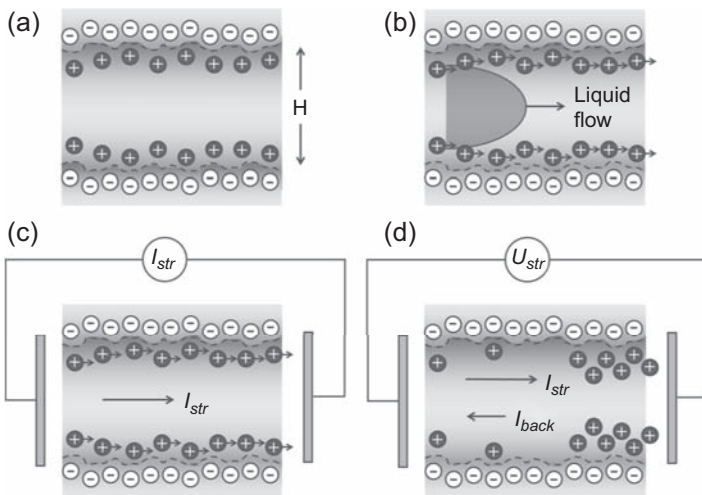

Figure 9.3 Generation of streaming current I_{str} and streaming potential U_{str} upon liquid flow in a capillary channel with appropriate channel height H .

protonation and de-protonation of surface functional groups and from the adsorption of hydroxide and hydronium ions. In equilibrium the surface charge is partially compensated by counter-ions of the surrounding liquid that accumulate at the solid–liquid interface (Fig. 9.3a). When moving the liquid phase along the solid surface, the counter-charges are sheared off and move in the direction of the liquid flow (Fig. 9.3b). The movement of charges causes the streaming current I_{str} (Fig. 9.3c), which may be measured with a highly sensitive ampere metre (the streaming current occurs in the range of a few nA to a few tens of nA). Connecting the measuring cell to a different electronic circuit with a high internal impedance, the streaming current is opposed by a backflow current I_{back} . When streaming and backflow currents are in equilibrium, the streaming potential may be measured (Fig. 9.3d).

The relations between the electrokinetic effects of streaming potential and streaming current and the zeta potential date back to the beginning of the last century (Smoluchowski, 1905; Lyklema, 1995). The streaming current is related to the geometric dimensions of the capillary channel (cell constant L/A where L is the length and A the cross-section of the flow channel) to calculate the zeta potential as,

$$\zeta = \frac{dI}{d\Delta p} \cdot \frac{\eta}{\varepsilon \cdot \varepsilon_0} \cdot \frac{L}{A}, \quad (9.1)$$

where Δp is the pressure difference across the flow channel and η and $\varepsilon \times \varepsilon_0$ are the dynamic viscosity and permittivity of the electrolyte solution. Streaming current and streaming potential are related by the Ohm resistance R inside the flow channel and Eq. (9.1) may therefore be expressed as,

$$\zeta = \frac{dU}{d\Delta p} \cdot \frac{\eta}{\varepsilon \cdot \varepsilon_0} \cdot \frac{L}{A} \cdot \frac{1}{R} \quad (9.2)$$

For randomly packed fibre plugs, a well-defined flow channel and thus the exact dimensions L and A are not accessible. However, the cell constant L/A may be determined by the measurement of resistance and conductivity κ ,

$$\frac{L}{A} = R \cdot \kappa \quad (9.3)$$

Combining Eq. (9.3) with Eq. (9.2), we get

$$\zeta = \frac{dU}{d\Delta p} \cdot \frac{\eta}{\varepsilon \cdot \varepsilon_0} \cdot \kappa_B, \quad (9.4)$$

where the subscript B of κ_B indicates that the conductivity is measured in the bulk electrolyte solution. The zeta potential calculated according to Eq. (9.4) is correct provided that the assumption is valid that the electrical conductivity inside the

permeable plug of fibres is carried by the aqueous electrolyte only. Eq. (9.4) thus neglects the possible occurrence of surface conductance or similar conductivity effects contributed by the solid sample when immersed in an aqueous solution. Such assumption is correct for measuring conditions where the dimension of the plug capillaries between adjacent fibres appears large compared to the extension of the EDL. The extension of the EDL into the liquid phase depends on the ionic strength of the aqueous solution and thus on the solute concentration. Another prerequisite for the validity of Eq. (9.4) is the absence of any contribution of material conductance to the total electrical conductivity.

While the extension of the EDL limits the applicability of Eq. (9.4) to a certain electrolyte concentration and packing density for all kinds of fibre samples (e.g. cellulose, polymer or glass fibres), the swelling behaviour of natural fibres in hydrophilic conditions also introduce some extra conductivity. A variety of different methods have been assessed in the literature to compensate the effect of the increased conductivity inside the fibre plug compared to the bulk electrolyte conductivity. Among these methods, two approaches are commonly used to correct the apparent zeta potential calculated by Eq. (9.4) for the influence of surface conductance. The approach by Chang and Robertson (1967) considers the dependence of the apparent zeta potential on the packing density of the fibre plug. With this assumption, Eq. (9.1) can be written as:

$$\zeta = \frac{dI}{d\Delta p} \cdot \frac{\eta}{\varepsilon \cdot \varepsilon_0} \cdot \frac{L}{A} \cdot e^{B \cdot d} \quad (9.5)$$

The correct zeta potential is determined by the extrapolation of the packing density $d \rightarrow 0$ (single-capillary case) using the linear form of Eq. (9.5),

$$\ln \left(\frac{dI}{d\Delta p} \cdot \frac{\eta}{\varepsilon \cdot \varepsilon_0} \cdot \frac{L_{cell}}{A_{cell}} \right) = \ln \zeta - B \cdot d \quad (9.6)$$

The approach of Chang and Robertson requires the measurement of streaming current or streaming potential at different packing densities of the same fibre plug. Therefore, a more convenient and accomplished approach determines the cell constant L/A of Eq. (9.1) by measuring the cell resistance and electrolyte conductivity at higher ionic strength of the aqueous solution (Fairbrother and Mastin, 1924). Under these conditions, any additional conductivity effect introduced by the solid sample is suppressed and becomes negligible. The modified Eq. (9.1) then reads,

$$\zeta = \frac{dI}{d\Delta p} \cdot \frac{\eta}{\varepsilon \cdot \varepsilon_0} \cdot R_{0.1 \text{ N KCl}} \cdot \kappa_{0.1 \text{ N KCl}}, \quad (9.7)$$

where $R_{0.1 \text{ N KCl}}$ and $\kappa_{0.1 \text{ N KCl}}$ refer to the resistance and conductivity of a 0.1 N KCl solution, which is recommended for the determination of the cell constant.

9.2.2 Experimental methods

The streaming potential measurement of natural fibres has been realized by a variety of differently designed measuring devices. In the simplest case, a differential pressure is generated by raising the reservoir beaker with measuring liquid to an elevated level relative to the drain beaker (Zembala and Adamczyk, 2000). An advanced approach uses a continuously working pump for liquid transport. A peristaltic or rotary pump allows a better control of the liquid flow and thus of the differential pressure and the design of a commercial analyzer (Anton Paar GmbH, 2003). Most recently an instrument using a syringe pump system for liquid transport is available, which offers the possibility of better flow control even for miniaturized sample size (Anton Paar GmbH, 2009). The latest generation of instruments incorporates a novel method for liquid transport that applies a pressure decline during the streaming potential and streaming current measurement without using either a mechanical pump or an external gas reservoir (Luxbacher, 2018a).

Both home-made apparatuses and commercial instruments apply the permeation mode of measurement, where an aqueous solution passes through a randomly aligned fibre plug mounted in a cylindrically shaped measuring cell. The schematic drawing of an appropriate measuring cell design is shown in Fig. 9.4.

The aqueous electrolyte solution passes through the permeable fibre plug and generates a pressure difference between the inlet and the outlet of the measuring cell and the corresponding streaming potential signal. In order to eliminate any influence of electrode polarization, the streaming potential is preferentially recorded at increasing pressure difference between both ends of the fibre plug. The dependence of streaming potential on the differential pressure is strictly linear assuming that the boundary condition of laminar flow of liquid through the permeable sample is fulfilled. Fig. 9.5 shows the linear dependence of streaming potential on the applied pressure gradient measured for a bleached cotton fibre sample within a reasonable pressure range.

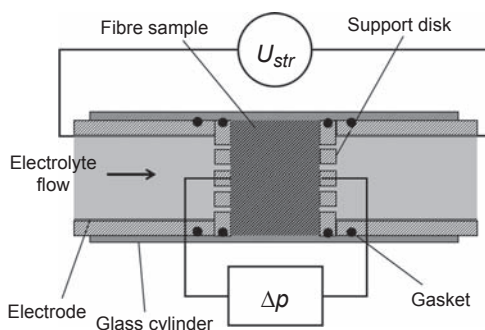

Figure 9.4 Measuring cell design for streaming potential measurement of fibre samples (Anton Paar GmbH, 2009).

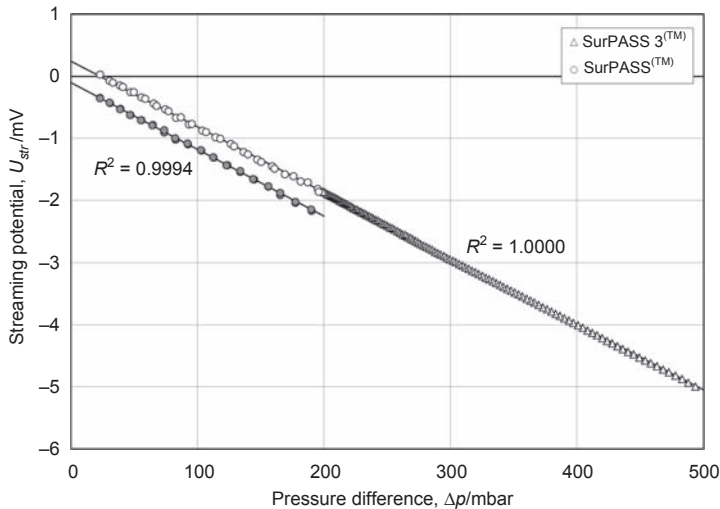

Figure 9.5 Streaming potential versus differential pressure for a bleached cotton sample (0.01 mol/L KCl, pH 5.5; Luxbacher, 2018b) obtained with two different commercial instruments.

With the sample mounting indicated in Fig. 9.4, the streaming potential coupling coefficient $dU/d\Delta p$, which is dependent on the packing of the fibre plug, is related to the electrical conductivity κ_B of the electrolyte solution to calculate the zeta potential according to Eq. (9.4). The possible contribution of surface or material-specific conductance to the overall conductivity inside the fibre plug lets us estimate an apparent zeta potential only. For the sake of reproducibility of the streaming potential coupling coefficient and thus of the apparent zeta potential, a reproducible packing density of the fibre plug must be maintained. The weight of the fibre sample and its compression determine the packing density. Knowledge about the liquid flow behaviour is essential to control the sample permeability and thus the reproducibility of the streaming potential measurement.

9.2.3 The zeta potential of natural fibres

The electrical charges on surfaces of cellulosic fibres play a major role in their applications in papermaking or textile technology. The electrical charges determine the zeta potential at the fibre–liquid interface upon immersion of the fibres in an aqueous solution. The zeta potential predicts the electrostatic interaction between individual fibres or between the fibres and the aqueous environment that is used for fibre processing. Although cellulosic fibres such as cellulose pulp, cotton, regenerated cellulose or other lignocellulosic plant fibres are among those natural fibres whose electrokinetic properties are studied most frequently, the zeta potential characterization of other natural fibres such as human hair, wool or silk is as important in the fields of cosmetics or textiles.

The type and number of surface charges are the primary properties of the fibre surface, which determine the zeta potential. The surface charge is generated by the interaction of surface functional groups with the aqueous environment and is a function of the pH value of the electrolyte solution. Fig. 9.6 shows the pH dependence of zeta potential typical for a surface rich in acidic functional groups (which generate negatively charged residues upon exposure to water), a surface dominated by basic functional groups, and a surface with amphoteric character. The latter property may arise either by the presence of weakly acidic or basic (i.e. amphoteric) functional groups or by the more or less equal distribution of acidic and basic functional groups with comparable (acidic and basic) strength. For a surface with acidic groups, the isoelectric point (iep; the pH of the electrolyte solution where the net surface charge density and thus the zeta potential assume $\sigma = 0 \mu\text{C}/\text{cm}^2$ and $\zeta = 0 \text{ mV}$, respectively) occurs at low pH. Basic surface groups shift the iep to high, pH. For amphoteric surfaces, the iep is found in the neutral range.

A second contribution to surface charge arises from the adsorption of molecules and ions contained in the liquid phase on the fibre surface. Besides the adsorption of charged molecules (whose charge is again pH dependent), the accumulation of the dominant molecule present in the aqueous solution — water itself — must not be neglected when interpreting the measured zeta potential. Water adsorption at the fibre surface and its penetration into the fibre structure affects the surface charge and thus the magnitude of the zeta potential. The adsorption of water and its dissociated ions, hydroxide (OH^-) and hydronium (H_3O^+), determine the interfacial charge of polymer surfaces. Fig. 9.6 also displays the general trend of the zeta potential for a surface without dissociable groups common to pristine polymers. The effect of different

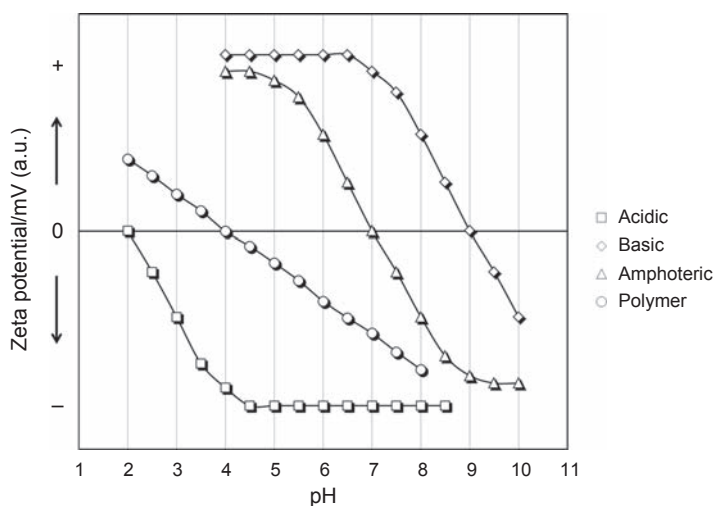

Figure 9.6 Dependencies of the zeta potential on the pH of an aqueous solution of a 1:1 electrolyte for surfaces with acidic, basic and amphoteric functional groups, and for polymer surfaces without dissociable groups.

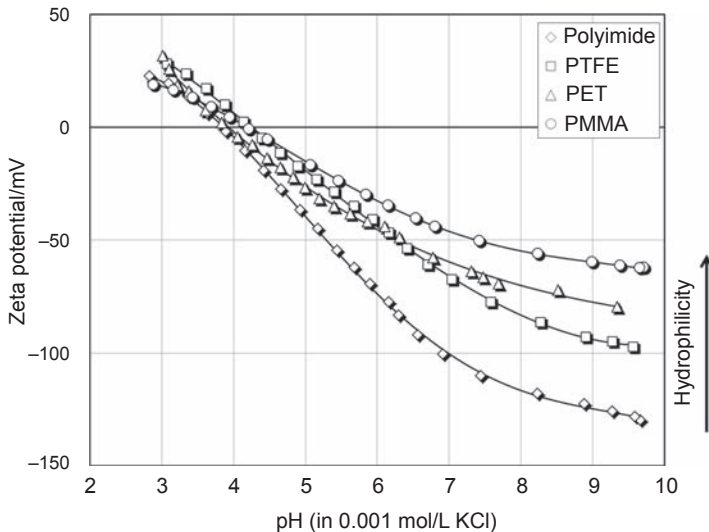

Figure 9.7 Zeta potential of polymer surfaces with different hydrophobicity.

hydrophobicity of polymer surfaces on the zeta potential is shown in Fig. 9.7. The iep at pH 4 is common to all polymer surfaces with a lack of dissociable functional groups (Zimmermann et al., 2010). The decrease in negative zeta potential corresponds to an increase in the surface hydrophilicity and correlates with the decrease in the water contact angle (Kühn and Jacobasch, 1986). For natural fibres, the contribution of hydroxide and hydronium ion adsorption to the total surface charge is commonly suppressed by the presence of dissociable functional groups. However, as discussed in Section 9.3.5, the conversion from natural to bleached hair is an example where the surface charge formation is determined by the transfer from a hydrophobic to a hydrophilic surface.

The ionic strength of the measuring liquid determined by the concentration of the electrolyte solution is another parameter that affects the zeta potential. For a simple 1:1 electrolyte (e.g. NaCl, KCl) a selective interaction with the fibre surface is not assumed and the zeta potential follows a successive decrease with increasing ionic strength (see Fig. 9.8). Such concentration dependence gives information about the magnitude of surface conductance and serves as a baseline for the investigation of selective interaction between the solid surface and a complex electrolyte with divalent or trivalent cations or anions. The surface conductance, represented by the difference between the apparent and correct zeta potential at low ionic strength, is determined by the concentration of ions in the stationary layer of the EDL and thus by the solid surface charge. Although less important for rigid surfaces, the surface conductance or – more precisely – the interfacial conductance is a property that is strongly linked to materials with brush-type surfaces or to the process of surface swelling.

The structure and chemistry of natural fibres make them highly accessible for water. Water may enter the porous surface of fibres, which causes the fibre to swell significantly. The swelling process has a dramatic effect on the zeta potential. Firstly,

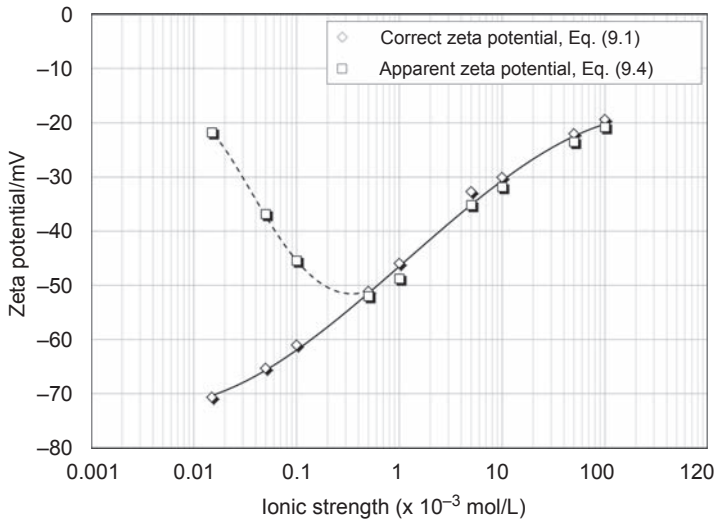

Figure 9.8 Dependence of apparent and correct zeta potential on the ionic strength of a 1:1 electrolyte (microscope slide, KCl, pH 5.5).

uncharged water molecules, which are dominantly present at the fibre–liquid interface, not only refrain from participation in the interfacial charge formation process, but also shield the contribution of dissociated surface groups. Secondly, the incorporation of water molecules expands the fibre surface and shifts the plane of shear of the EDL towards the bulk liquid phase (Stana-Kleinschek et al., 2002). Both effects reduce the magnitude of the zeta potential. Thirdly, the penetration of the aqueous electrolyte solution into the porous fibre structure increases the fibre conductivity. The streaming potential is then measured in the presence of a fibre plug conductance which exceeds the electrolyte conductivity remarkably. Water inside the fibre pores furthermore opens additional paths for streaming potential/current, which add to the potential/current at the outer fibre surface and thus to the total zeta potential (Hubbe, 2006). This effect was already accounted for by Goring and Mason (1950a,b) and Chang and Robertson (1967), who determined the correct zeta potential of a fibre plug by the extrapolation of an apparent zeta potential to infinitely small fibre packing density.

The complex behaviour of swollen fibres is not restricted to cellulosic materials only but occurs also for hair especially after oxidative treatment (bleaching). The process of bleaching opens the hair structure and introduces acidic surface groups, which increase the hydrophilic character of the surface.

The rate of swelling may be observed by following the time dependence of zeta potential. Fig. 9.9 shows a typical swelling characteristic for a natural fibre sample. Kanamaru (1960) has assigned the temporal change of the zeta potential to first-order kinetics,

$$-\frac{d\zeta}{dt} = k \cdot (\zeta - \zeta_{EQ}) \quad (9.8)$$

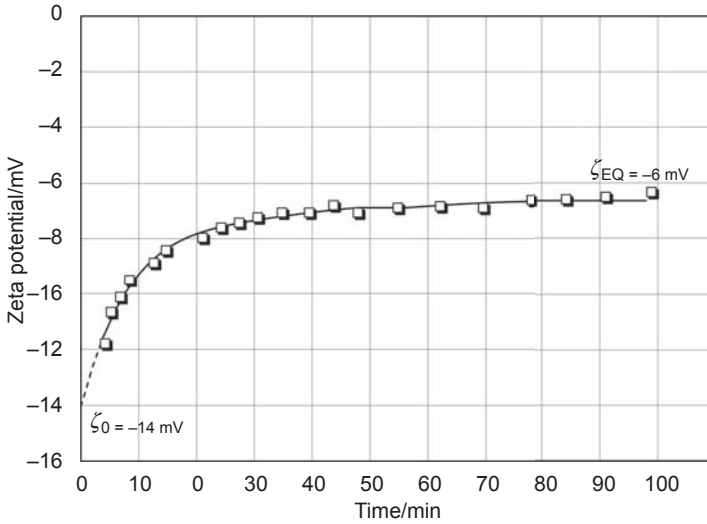

Figure 9.9 Time dependence of zeta potential for a natural fibre during swelling in aqueous solution.

Upon integration, Eq. (9.8) gives

$$-\ln \frac{\zeta - \zeta_{EQ}}{\zeta_0 - \zeta_{EQ}} = k \cdot t, \quad (9.9)$$

where ζ_0 is the zeta potential determined at first contact of the dry fibre sample with the aqueous solution and ζ_{EQ} is the zeta potential of the fibre when equilibrated. ζ_0 and ζ_{EQ} are determined from the time dependence of zeta potential by extrapolation to $t \rightarrow 0$ s (for ζ_0) and $t \rightarrow \infty$ (for ζ_{EQ}), respectively. The experimental data shown in Fig. 9.9 gives, $\zeta_0 = -14$ mV, $\zeta_{EQ} = -6$ mV, and an initial swelling rate $k = 0.08 \text{ min}^{-1}$.

The electrokinetic characterization of natural fibres offers another possibility for analysis to get information about the surface properties of fibres and their behaviour in fibre processing. The exposure of a fibre sample to a chemical compound dissolved in the measuring liquid changes its surface chemistry upon binding or adsorption of such compound on the fibre surface. The change in the zeta potential with increasing concentration of the additive in the aqueous electrolyte solution lets us determine an adsorption isotherm. The additive may be of different types such as salts, surfactant molecules, anionic and cationic polyelectrolytes (technical and biopolymers), or proteins and enzymes. In case of a titration of a fibre surface with acidic functional groups (giving a negative surface charge) with a cationic surfactant, the zeta potential changes sign at a certain surfactant concentration, which determines the point of zero charge (pzc) or point of charge reversal (pcr). This concentration is indicative for the number of surface groups that are available for the electrostatic interaction with process chemicals. The time-dependent change of the zeta potential after exposure

of the fibre sample to a certain concentration of the additive informs us about the adsorption or binding kinetics such as the initial rate of adsorption as well as the time for equilibration of the simultaneous adsorption and desorption processes. Examples for a binding isotherm and the adsorption kinetics are shown in Fig. 9.10. In Section 9.3, the application of various experimental approaches to the electrokinetic characterization of natural fibres is reviewed.

9.3 Applications

This section reviews literature data on the electrokinetic properties of natural fibres. Most of the zeta potential analyses described in the literature were performed for cellulosic fibres with focus on cotton. The increasing waste of plant fibres has introduced the needs for fibre processing and re-use, e.g. for reinforcement in light-weight composite materials, which drive the investigation of the surface properties of such fibres and thus of their zeta potential. In recent years, the value of zeta potential analysis was discovered for the understanding of the interaction of compounds dissolved in an aqueous solution with the fibre surface. The analysis of adsorption and desorption processes has become a major focus of the application of the zeta potential for the surface analysis of human hair, for example, to evaluate hair-care formulations. The various fields of zeta potential analysis for fibres are discussed in turn.

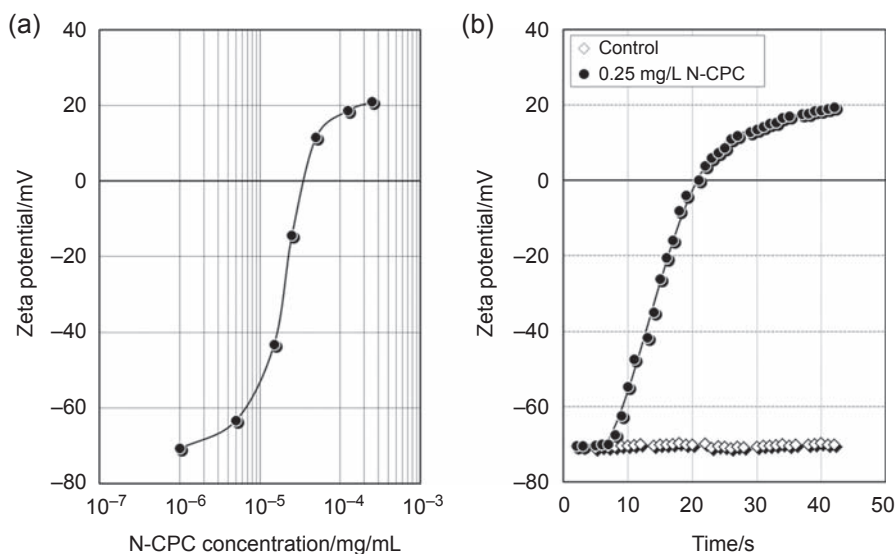

Figure 9.10 Binding isotherm (a) and kinetics of adsorption (b) of the cationic surfactant N-cetyl pyridinium chloride (N-CPC) on a natural fibre.

9.3.1 Cellulose pulp

The first attempts to determine the zeta potential of natural fibres focused on the measurement of cellulose pulp used for papermaking application. As early as 1950, the complexity of the determination of the correct zeta potential of fibre samples in the shape of a randomly arranged plug was recognized (Goring and Mason, 1950b). An extension of Eq. (9.1) was introduced and refined by other authors (Chang and Robertson, 1967) to correct the effect of surface conductivity that is caused by the proximity of neighbouring fibres in the sample plug. Despite the attempts made by these authors to find a quantitative approach to correct the zeta potential of fibre plugs, their method of extrapolating the apparent zeta potential measured at various fibre packing densities to the single-capillary limit is tedious and thus impracticable. Forty years later the topic was reconsidered in a phenomenological manner without changing the experimental access to the correct zeta potential (Hubbe, 2006). The phenomena of streaming potential and streaming current inside fibre plugs are probably better understood today; however, an operating procedure for a fast measurement is still missing. Although Eq. (9.4) gives an apparent zeta potential, only this initial approach is therefore still accepted. In the field of papermaking, the zeta potential information reduces to the determination of the sign of charges of pulp fibres and their change upon modification of the fibre surface by adding additives such as polyelectrolytes and other process chemicals. Simple streaming potential analyzers are nowadays applied to monitor and adjust the apparent surface charge of pulp fibres in the papermaking process (BTG, 2018; AFG Analytic, 2018). A more detailed analysis of the pH dependence of the apparent zeta potential reveals the different affinities of hardwood and softwood pulp towards swelling. Fig. 9.11 shows a similar evolution of the charging behaviour for cellulose pulp originating from spruce and beech, respectively, with a distinct difference at alkaline pH. The less negative apparent zeta potential for beech at higher pH suggests an increased conductance of hardwood pulp, which is explained

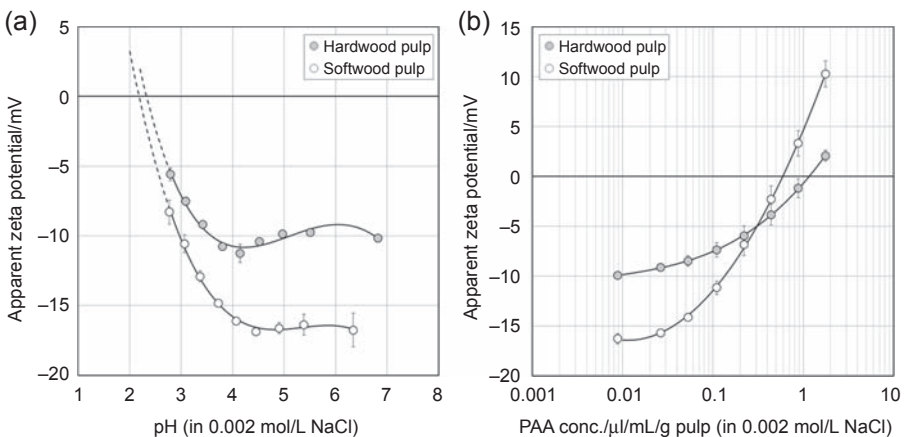

Figure 9.11 Dependence of zeta potential for hardwood (beech) and softwood (spruce) cellulose pulp on (a) pH and (b) concentration of poly(acryl amide), PAA.

by its enhanced swelling propensity. The adsorption isotherm of the cationic polyelectrolyte poly(acryl amide), PAA, reveals a higher pzc for hardwood pulp despite of its less negative zeta potential at pH 5-6. The higher consumption of PAA confirms the enhanced specific surface area for hardwood pulp, which is triggered by the stronger swelling propensity.

9.3.2 Cotton

Among natural fibres, cotton is by far the fibre sample whose electrokinetic properties have been investigated most extensively. The main reason for the ongoing interest in the surface charge of cotton fibres and fabrics is due to its use in textile applications. The processing of cotton involves several steps of pre-treatment to remove contaminants of the raw cotton fibre, bleaching to increase the number of reactive surface groups, and dyeing and finishing processes to obtain the final properties of the textile fabric. The electrokinetic properties of cotton are very suitable to monitor the efficiency of cotton treatment and thus to optimize the process conditions. Several authors have reported the effect of scouring, bleaching and mercerization of raw cotton. [Pusic et al. \(1999\)](#) used the pH dependence of zeta potential for raw, scoured, bleached and mercerized cotton fibres to visualize the effect of various treatments. [Fig. 9.12](#) shows the characteristic evolution of the negative zeta potential for a raw cotton fibre plug in the range of pH 2–9. Starting at a high pH, we first find an almost constant zeta potential of $\zeta = -15$ mV, which starts to decrease below pH 6. Towards a lower pH the zeta potential is approaching $\zeta = 0$ mV and thus the iep at pH 2 (extrapolated). This behaviour does not change for raw cotton fibres after treatment. However, the zeta potential is shifted to more negative values for scoured and bleached cotton

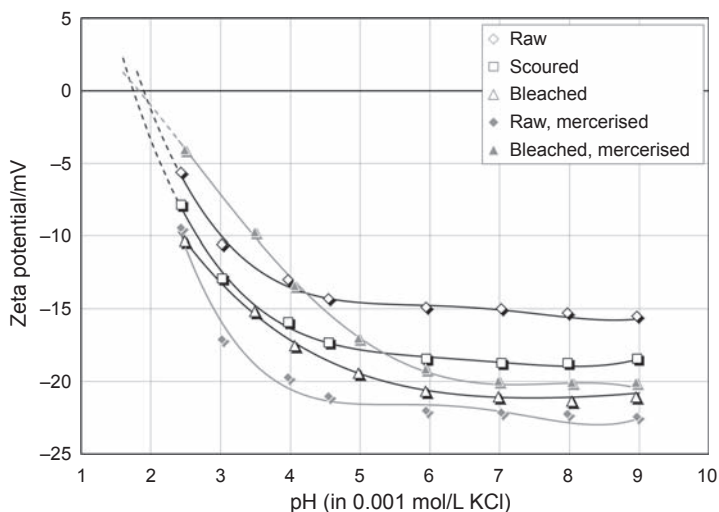

Figure 9.12 pH dependence of zeta potential for raw and differently treated cotton fibres ([Pusic et al., 1999](#)).

fibres with a constant (plateau) zeta potential at $\zeta = -19$ mV for scoured and $\zeta = -21$ mV for bleached cotton fibres, respectively. The low negative zeta potential for raw cotton fibres is assigned to the impurities such as pectin, waxes and other non-cellulosic compounds, which prohibit the accessibility of dissociable acidic surface groups of cotton and thus their contribution to the surface charge. After removal of these impurities (scouring) and partial oxidation of the remaining cellulose (bleaching), the hydroxide groups ($-\text{OH}$) and possible carboxylic acid groups ($-\text{COOH}$) become accessible leading to an increasing negative zeta potential. An extrapolation of the pH dependence of zeta potential for bleached cotton fibres towards lower pH indicates a shift of the iep to $\text{pH} < 2$ and thus the presence of a significant number of $-\text{COOH}$ groups.

The mercerization of the raw and bleached cotton fibres (24% NaOH, 18°C, 120 s) leads to almost the same negative zeta potential in the alkaline range; however, the effect of an acidic electrolyte solution on the surface charge is different for bleached mercerized fibres. Although the exact reason for this significant difference remains unclear from solely a zeta potential analysis, it nevertheless indicates that bleached cotton behaves differently to raw cotton upon exposure to highly concentrated alkaline solution.

The effect of different cleaning agents for the extraction of raw cotton impurities such as pectins and waxes was investigated by Ribitsch et al. (2001) who showed the effect of several surface and structural modification processes for the selective removal of individual impurities. HCl cleaning and alkaline treatment remove non-cellulosic compounds such as hemicellulose, waxes, pectin and proteins. Their results clearly indicate a stronger effect of alkaline treatment compared to HCl cleaning. Demineralization with polyphosphoric acid has an even stronger effect on the negative zeta potential of raw cotton and compares with the selective removal of wax components after petrol ether extraction. Stana-Kleinschek and Ribitsch (1998) presented an example for the use of changes in the electrokinetic properties for process optimization. With an increasing number of petrol ether extraction cycles the accessibility of the negative surface charge of successively cleaned raw cotton fibres is improved. The same authors investigated the effect of the alternative and more environmentally friendly enzymatic cleaning of raw cotton fibres (Ribitsch et al., 1996). The pH dependence of zeta potential for raw cotton fibres treated with the specific enzymes lipase and pectinase as well as with an enzyme mixture (containing xylanase, mannanase and cellulase) makes evident that the enzyme lipase has the strongest effect on the removal of hydrophobic impurities such as fatty acids and waxes. The effect is comparable with that of petrol ether extraction. Ribitsch et al. (1996) used another analytical approach and type of display of the effect of surface treatment. They detected the accessibility of negative surface groups of cotton fibres by monitoring the adsorption of an appropriate tracer molecule such as a cationic surfactant like the quaternary ammonium compound *N*-cetyl pyridinium chloride (N-CPC). The changes in the zeta potential were recorded with an increasing concentration of N-CPC starting at the zeta potential of the respective cotton fibre at a certain pH. For cotton surface analysis, this pH is selected in the alkaline range due to the assumed complete dissociation of the acidic functional groups of cellulose. At a certain concentration of N-CPC,

a charge reversal of the cotton fibre surface takes place. This pcr, which determines the concentration of N-CPC necessary to completely compensate the negative surface charge of cotton, is representative for the surface charge density. Again lipase had the strongest effect on the accessibility of surface functional groups compared to the other enzymatic treatment processes. The series of pcr values (smallest for enzyme mixture, largest for lipase treatment) differs from the series of negative zeta potential in the alkaline range (little difference between treatments with various enzymes). However, a comparison with the iep reveals two different activities of enzymes: the removal of non-cellulosic impurities and the chemical modification of the cotton fibre by oxidation thus introducing additional acidic surface groups. A contribution of hydrophobic interaction between the C₁₆ tail group of N-CPC and the non-cellulosic impurities of raw cotton must also be considered when comparing the pcr.

The streaming potential method was applied to gain information about the effect of washing of protein-stained raw cotton fabrics with the zeta potential used as an indicator for the washing efficiency (Luxbacher et al., 2008). Fig. 9.13 shows the complex surface properties of blood-stained raw cotton fabrics. The protein soiling by blood adds an amphoteric character to the raw cotton surface. After washing with a standard detergent, the zeta potential changes significantly and the iep of the washed fabric shifts towards the iep of the raw cotton fabric displayed in Fig. 9.13 for reference purposes. Protein soiling is difficult to remove with a standard detergent only. Addition of the enzyme amylase to the detergent and washing at the same bath temperature enhances the cleaning efficiency. The even higher negative zeta potential of the stained cotton fabric after washing in the presence of the enzyme compared to raw cotton indicates an additional removal of the natural impurities and a partial bleaching of the raw cotton fabric. Recently a standard cotton fabric, which is certified as a

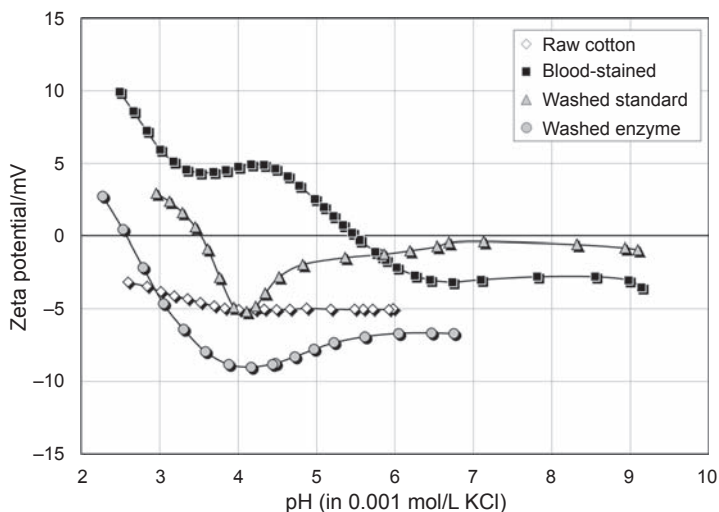

Figure 9.13 Zeta potential of raw, blood-stained, and washed cotton fabrics (Luxbacher et al., 2008).

crockmeter test fabric according to ISO standard F09-105 (ISO, 2009), was suggested as a reference material for the verification of instruments used for the surface zeta potential analysis (Luxbacher, 2018b). This fabric fulfills the requirements that the zeta potential method puts on such a reference material: It is commercially available, inexpensive, manufactured in a reproducible way (to comply with ISO F09-105), has a hydrophilic surface and a large surface area. The target zeta potential of the standard cotton fabric at the native pH 5.5-6.5 of an aqueous 0.01 mol/L KCl solution was specified as $\zeta = -(20 \pm 2)$ mV. The tolerance of $\pm 10\%$ is suggested by the ISO standard 13099-2 for the complementary electrophoretic light scattering technique that determines the zeta potential in particle dispersions and emulsions (ISO, 2012).

9.3.3 Other cellulosic fibres

The swelling characteristics and the correlation with the moisture content of natural cellulose fibres was investigated in detail by Bismarck et al. (2002) by studying the time dependence of the zeta potential. They showed the temporal decrease in the negative zeta potential for differently treated flax fibres as a representative example for natural cellulose fibres that are assigned as potential candidates for reinforcement in polymer composite materials. The higher degree of swelling of unmodified flax fibres becomes also obvious from the pH dependence of the zeta potential of these fibres. They found a remarkable difference in the plateau values of the negative zeta potential for natural and purified flax fibres. The purification and flax fibre separation processes involved dew retting, steam-heating and alkali treatment. A significant degree of swelling leads to an extension of the fibre 'surface' towards the bulk aqueous phase surrounding the fibre. The position of the fictive shear plane that determines the zeta potential is also shifted thus decreasing the magnitude in the zeta potential. Higher swelling also increases the electrical conductance of the wet fibre plug, which may be measured in addition to the streaming potential to confirm the situation inside the fibre plug. Strongly swelling fibres show the characteristic increase in the negative zeta potential that occurs below pH 5. The negative zeta potential passes a maximum before decreasing in the same manner as for other non-swollen material surfaces. The maximum in the negative zeta potential is associated with a minimum in the conductance. Cellulose fibres show therefore a stronger swelling in the neutral and especially in the alkaline range. Such behaviour is also found for bleached hair fibres despite their different surface chemistry as discussed in Section 9.3.5.

Inglesby et al. (2005) investigated the changes of the electrokinetic properties of rice straw after solvent extraction, which was applied as an attempt to modify waste plant fibres for further use in fibre-reinforced composite materials. Although little difference between untreated and solvent extracted rice straw was observed, the shift in the iep towards lower pH was assumed significant and assigned to the successful removal of mineral salt impurities masking the surface functional groups of the ligno-cellulose fibres.

A similar approach to pre-treatment was performed with jute fibres (Bellmann et al., 2005). Different from rice straw, extraction of waxes from raw jute using a benzene-ethanol mixture increased the negative zeta potential as shown in Fig. 9.14.

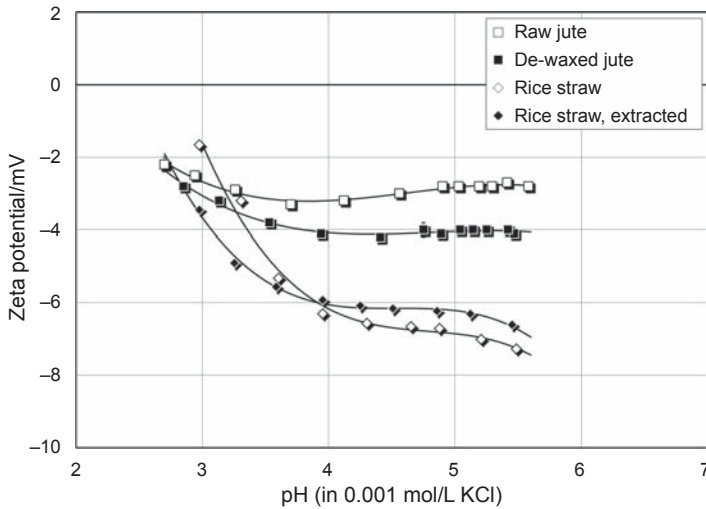

Figure 9.14 Effect of extraction of waxes with alcohol-benzene azeotropes on the zeta potential of jute (Bellmann et al., 2005) and rice straw fibres (Inglesby et al., 2005).

Poathan et al. (2002) moved a step further and treated cellulose fibres obtained from banana plants with different silanes. A silane coupling agent is commonly applied in a sizing agent to achieve a strong adhesion between the reinforcing fibre and the polymer resin of the composite material. Fig. 9.15 shows the effect of silane treatment of a cellulose fibre. The final zeta potential is determined by the functional group introduced by the respective silane. Silane vinyl triethoxy silane (VTS) contains a vinyl

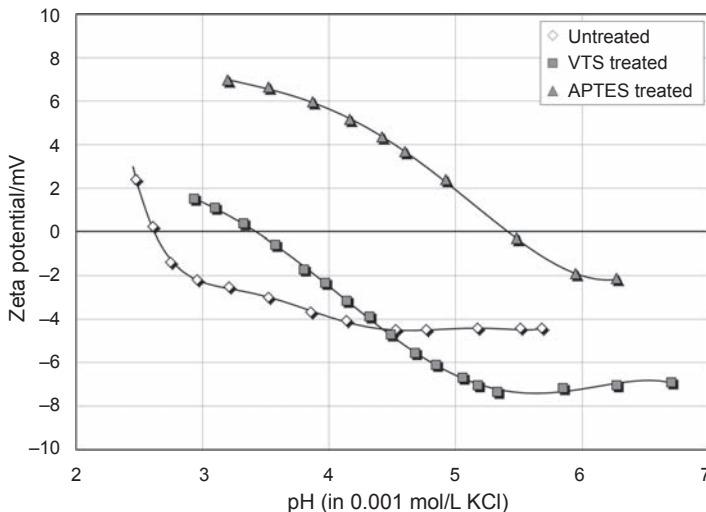

Figure 9.15 Effect of silane treatment on the zeta potential of a lignocellulose fibre (VTS... vinyl triethoxy silane, APTES... aminopropyl triethoxy silane; Poathan et al., 2002).

group which increases the hydrophobic character of the sized fibre. The iep shifts towards pH 4, which is indicative for an inert polymer surface. The treatment with silane aminopropyl triethoxy silane (APTS) introduces primary amino groups which give the treated cellulosic fibres a basic surface property. The iep is shifted towards an alkaline pH; however, the extent of this shift in Fig. 9.15 indicates only partial coverage of the cellulosic surface with the silane. Full coverage of the fibre surface with APTS let us expect an iep at pH 9 (Plonka et al., 2004). Alternatively to the interpretation of an incomplete coverage with APTS, the orientation of the silanol group towards the hydroxide groups of the cellulose surface may be reversed and the $-NH_2$ group of some APTS molecules may be consumed by hydrogen bonding to the cellulose $-OH$ groups.

9.3.4 Regenerated cellulose

Ribitsch et al. (2001) compared the electrokinetic properties of the regenerated cellulose fibres viscose, lyocell and modal with cotton (a natural cellulose fibre). For all regenerated cellulose fibres they measured a similar zeta potential, which is significantly smaller than the zeta potential for cotton. The explanation for this behaviour is found in the swelling characteristics of these different cellulosic fibres. Fig. 9.16 shows the time dependence of zeta potential for regenerated cellulose fibres and bleached cotton after first exposure to the aqueous measuring liquid (Stana-Kleinschek et al., 2001). The negative zeta potential decreases with a similar rate for all fibres; however, the ratio between the initial and equilibrium zeta potential values differs significantly. The relative change in the zeta potential, $(\zeta_{EQ} - \zeta_0)/\zeta_0$, is related to the water uptake capability of the dry fibre or the maximum moisture

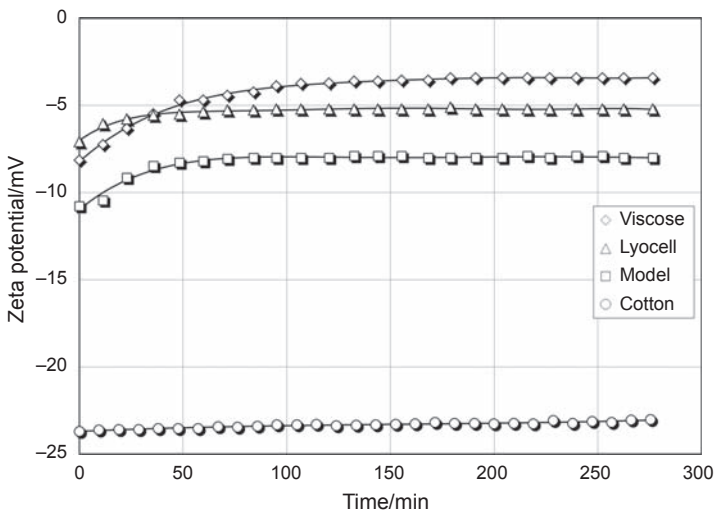

Figure 9.16 Time dependence of zeta potential for bleached cotton and regenerated cellulose fibres (1 mmol/L KCl, pH 8.5).

content of the fibre (Baltazar-y-Jimenez and Bismarck, 2007). It is highest for viscose. Stana-Kleinschek et al. (2002) tested the accessibility of surface functional groups by the adsorption of the cationic surfactant N-CPC, which reveals two distinct regions: a pcr at a very low concentration of N-CPC for regenerated cellulose fibres and pcr values at a significantly higher N-CPC concentration for differently treated cotton fibres. As an alternative to cotton, regenerated cellulose fibres such as viscose or lyocell have been explored as a fibre blend for composite fabrics used in advanced textile technology. The zeta potential analysis of a combination of different material surfaces such as a polymer and a natural fibre makes the effect of material properties such as hydrophilicity, swelling or porosity evident besides indicating the different mechanisms of surface and interfacial charge formation. Fig. 9.17 compares the zeta potential of a blend fabric composed of 33% lyocell and 67% polyester fibres with the zeta potential of pure fabrics. Other than for cotton-modacryl blends (Petricin et al., 2018), the zeta potential of the lyocell-polyester blend coincides with the average zeta potential calculated from the results obtained for the pure fabrics. This coincidence indicates the absence of fibre porosity or of any severe swelling for lyocell.

9.3.5 Human hair

The second-largest source for electrokinetic data of natural fibres is available for human hair. Human hair as a natural keratin fibre is subject to various testing of cosmetic products for hair care and hair treatment. Unlike the case of cotton fibres, the electrokinetic characterization of human hair starts with the virgin hair, which is

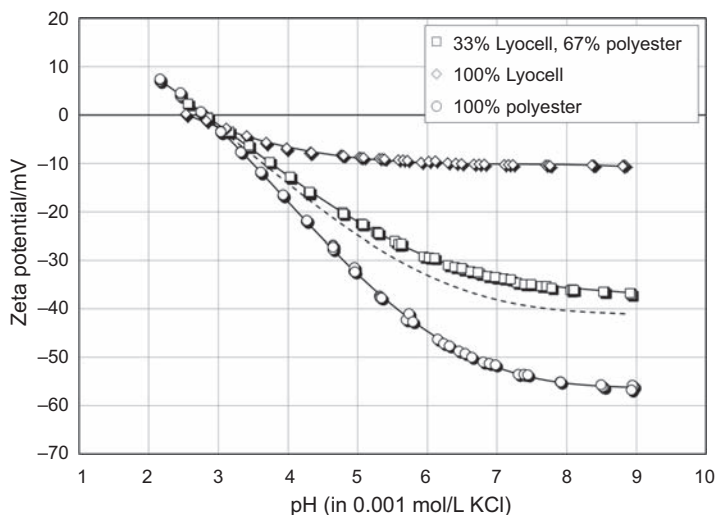

Figure 9.17 pH dependence of zeta potential for polyester and lyocell fabrics and for a fabric blend made of 67% polyester and 33% lyocell. The *dashed curve* indicates the expected pH dependence of the zeta potential for the blend fabric calculated from the experimental data for the pristine polyester and lyocell fabrics.

grown under well-controlled conditions and lacks any kind of treatment. The surface of natural hair fibres is hydrophobic similar to raw cotton; however, the hydrophobicity of the latter fibre originates from the different impurities. While cotton becomes more hydrophilic upon cleaning, human hair increases its wettability after chemical treatment such as bleaching or shampoo application. Bleaching of hair leads to a permanent modification of the surface chemistry, while the adsorption of shampoo ingredients only leads to a temporary increase in the hydrophilicity of hair. Although the main objective of the zeta potential analyses of hair is a qualitative testing of the interaction between liquid hair treatment agents with the hair surface, some authors have discussed such interaction also quantitatively. [Parreira \(1980\)](#) and [Jachowicz and Berthiaume \(1989\)](#) determined the zeta potential of virgin human hair fibres in an aqueous 10^{-4} N KCl solution. Although the hair samples used by both authors were comparable (same supplier, slightly different pre-treatment), the magnitude in zeta potential was found to be significantly different. Despite this difference, the reasons for which may vary (different hair chemistry, different packing density inside the measuring cell, consideration of surface conductance), the same iep at pH 3.4 ± 0.1 is reported by both authors.

[Jachowicz et al. \(1985\)](#) investigated the time and concentration dependencies of the adsorption of polyelectrolyte and surfactant molecules on human hair. They thereby simulated the effect of a hair conditioner by selecting different cationic polyelectrolytes and monitoring their modification of the surface charge of virgin hair. They further looked at competitive adsorption processes by subsequent exposure of the cationic polyelectrolyte-treated hair to either an anionic surfactant or an anionic polyelectrolyte. Their results clearly indicate the compensation of the positive surface charge of the cationic polyelectrolyte-treated hair by the more powerful anionic polyelectrolyte compared to the surfactant even at a concentration well above its critical micelle concentration.

Bleaching of hair affects the fibre structure and enhances swelling of the bleached hair in aqueous solution. Swelling expands the hair fibre diameter and makes the hair-water interface less distinct. The shear plane of the electrochemical double layer (where the zeta potential is determined) gets shifted towards the bulk liquid phase, which makes the streaming potential and thus the zeta potential less effective. [Stana-Kleinschek et al. \(2002\)](#) discussed the effect of fibre swelling on the position of the shear plane and thus on the zeta potential. Assuming the same surface charge and surface potential, the magnitude of the zeta potential decreases with the degree of swelling and therefore with the degree of bleaching. The zeta potential of differently bleached hair is shown in [Fig. 9.18](#). Upon bleaching, the hair fibres become more hydrophilic. The surface charge of bleached hair is primarily generated by the interaction of functional groups with water (de-protonation of sulfonic acid groups) with their surrounding hydrophilic surface covered by water molecules. We observe a similar trend in the zeta potential when comparing with photochemical or other oxidative treatments of hydrophobic man-made polymer surfaces ([Temmel et al., 2005](#)). For bleached hair fibres, the penetration of electrolyte solution into the more open

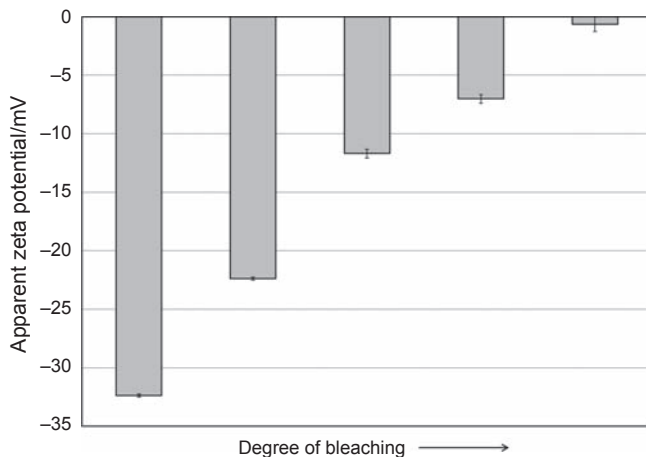

Figure 9.18 Effect of bleaching on the zeta potential of hair fibres.

and swollen hair fibre structure increases the conductance of the hair fibre plug in the measuring cell. Application of Eq. (9.4) for calculating the (apparent) zeta potential from streaming potential measurement introduces an increasing underestimation of the zeta potential with increasing difference between the electrolyte conductivity and the total conductance in the measuring cell. Another effect of the decrease in the streaming potential with increasing degree of bleaching is caused by a variation of the distance between individual hair fibres in the measuring cell. Bleached hair fibres become much more tightly compressed than virgin hair (a smaller amount of bleached hair is necessary to achieve the same plug permeability). The closer proximity of bleached hair fibres introduces the additional effect of surface conductance, which is presumably suppressed for virgin hair at the ionic strength of 1 mmol/L. The surface conductance eliminates the contribution of streaming potential within the fibre to the total streaming potential measured, whereas this contribution is observed for more hydrophobic fibres. Despite these factors, which sum up to the observed trend in the apparent zeta potential with increasing degree of bleaching shown in Fig. 9.18, we can make use of the zeta potential to access information about the increasing number of functional surface groups.

The electrokinetic behaviour of strongly bleached hair is very similar to natural lignocellulosic plant fibres. Fig. 9.19 compares the pH dependencies of the zeta potential for virgin and bleached human hair with the pH dependence of the zeta potential for untreated flax fibres. Firstly, the significant difference in the magnitude of zeta potential between virgin and bleached hair becomes obvious. The main reason is the change from a hydrophobic surface for virgin hair to a hydrophilic surface for bleached hair. Secondly, the zeta potential of bleached hair fibres shows a distinct maximum in the range of pH 3–4. This characteristic feature reflects the change in the hair fibre plug conductivity at lower pH due to a decline of the hair fibre swelling.

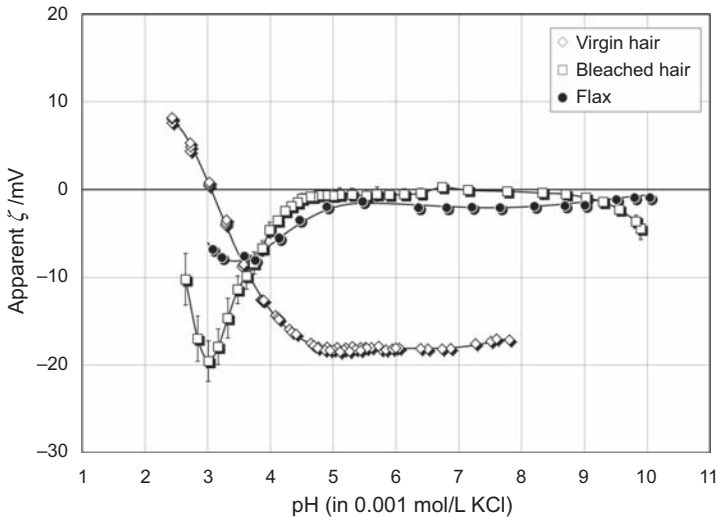

Figure 9.19 pH dependence of zeta potential for virgin and bleached human hair. Comparison with natural flax fibres.

Thirdly, the iep for bleached hair is shifted towards lower pH confirming the formation of sulfonic acid groups, which originate from oxidation of the thiol groups primarily of cysteine, upon bleaching. Finally the magnitude of the zeta potential of strongly bleached hair and its evolution with electrolyte pH resembles the electrokinetic behaviour of the lignocellulosic flax fibre.

9.4 Future trends

Although the electrokinetic properties of cotton fibres as the most prominent member of natural fibres for zeta potential analysis have been investigated for almost 100 years, a complete understanding of all phenomena occurring within the fibre structure and on the fibre surface still requires fundamental research. The drawback of fibres having an irregular surface, which prevents the exact determination of the zeta potential, is compensated by the large surface area of porous fibre plugs giving rise to satisfactory measurement reproducibility. Nonetheless, work is in progress to elucidate the different phenomena contributing to the streaming potential signal and thus to the better understanding of the electrokinetic properties of natural fibres.

Besides the fundamental research on electrokinetic and related properties of natural fibres, which contributes to the understanding of the chemical and physical properties of fibres most relevant for their successful technical application, experimental approaches for a realistic simulation of technical processes are also available from the literature. [Gonzalez-Caballero et al. \(1988\)](#) and [Espinosa-Jimenez and Gonzalez-Caballero \(1991\)](#) investigated the uptake of reactive dyestuff by bleached cotton fibres

using the zeta potential as an indicator. This approach was also applied by [Ramesh Kumar and Teli \(2007\)](#) for cotton fibres pre-treated with polymer resins.

A current trend in textile technology is the functionalization of textile surfaces in order to achieve different effects, such as antimicrobial behaviour, comfort of wear, flame retardancy, water repellence, or breathability. Microencapsulation was discovered as a potential tool to introduce such functions on standard cotton fabrics. Very recently, the streaming potential method has been used to assess the fixation and stability of microencapsulated compounds on cotton fibres and fabrics ([Eureka, 2010](#); [Pusic et al., 2011](#)).

The recent literature indicates the successive replacement of studies of the zeta potential for the characterization of cotton and regenerated cellulose fibres in textile processing by the investigation of other natural fibres for different applications. A reinforcement of polymer composite materials by plant fibres is driven by ecological reasons. The electrokinetic properties reveal success or the possible failure of cellulose-based plant fibres ([Aranberri-Askargorta et al., 2003](#); [Bismarck et al., 2001](#)). Cotton and cellulose derivatives are investigated for medical use ([Payerl et al., 2017](#)). Fibres and nonwovens of the biopolymer chitosan are potential candidates for artificial skin replacement ([Matsumoto et al., 2007](#); [Ristic et al., 2015](#)). Especially in the field of -biomaterials, the interaction between the surface of natural fibres and proteins in solution is affected by the surface charge of both solid and liquid components. The electrokinetic properties of fibres and their changes upon exposure to aqueous solutions that contain various biological components is currently the focus of many research activities. The classical streaming potential method for the electrokinetic characterization of solid surfaces is being rediscovered and the number of applications is growing fast.

The knowledge of the electrokinetic behaviour of hair fibres experiences growth by the time-resolved investigation of binding processes of the ingredients for shampoos and conditioners following the method proposed by [Jachowicz et al. \(1993\)](#). This approach combines the simulation of hair treatment with the analyses of adsorption and desorption kinetics at conditions close to real-life conditions.

9.5 Conclusion

Although the prerequisites for the electrokinetic characterization of natural fibres were introduced in the 1950s, the zeta potential has been routinely applied for only 20 years. The main reasons for this delay were the absence of commercially available measuring instruments and the fact that the knowledge of zeta potential characterization of fibres and other solid surfaces was limited to a small number of experts. However, since 1990, the diversity of different fibre samples investigated by a variety of research groups reflects the growing interest in this technique to understand the interfacial properties of natural fibres. In this chapter, the theoretical aspects of the electrochemical double layer and the equations relevant for the determination of the surface zeta potential were highlighted. For fibre surface and interface analyses, the zeta potential

was treated as an indicator for the pH titration of the surface functional groups, the interaction of fibres with dissolved components such as salts, surfactants, or natural and technical polyelectrolytes (including proteins and enzymes), and the monitoring of swelling processes. Examples from the literature were selected to demonstrate the main use of the zeta potential for the characterization of cotton and regenerated cellulose fibres for textile application, of lignocellulosic plant fibres as a possible source for reinforcing composite materials, and of human hair especially for testing hair-care products such as shampoos and conditioners.

9.6 Sources of further information and advice

Despite the many publications on the topic of electrokinetic properties of natural fibres found in the literature, a comprehensive textbook discussing the characterization of the zeta potential of these fibres is still missing. Even for the application of the streaming potential measurement for solid surface analysis, only brief sections in textbooks for zeta potential and colloidal and interfacial science are available. Instead the interested reader is referred to the concise ZETA Guide, a booklet highlighting the basic principles of the surface zeta potential method and illustrating representative application examples including the zeta potential analysis of natural fibres (Luxbacher, 2014). The interested reader is further referred to the books of Robert J. Hunter (Hunter, 1981; Hunter, 2001) and to the encyclopaedia of Johannes Lyklema (Lyklema, 1995). Information about the principles of the various measuring techniques is partially available on the websites of the manufacturers of the corresponding measuring instruments. A review of the early work on the electrokinetics of cellulose fibres is highly recommended. Onabe (1978, 1979a,b,c) published a series of comprehensive papers about the various aspects of the assessment of cellulose-polyelectrolyte systems representative for many natural fibres and their various applications.

Although different from natural fibres, the work by Werner et al. (1998) explains and applies the principles of the streaming potential and streaming current method for the electrokinetic characterization of solid surfaces.

Despite the complexity of electrokinetic properties of natural fibres and its consequences for the determination of the zeta potential, the approach of streaming potential measurement has been accepted and widely used with significant success. The primary result of a standard streaming potential measurement gives an apparent zeta potential only; however, the information provided is most satisfactory and hardly requires any tedious correction for interfacial conductivity effects. Neglecting the contribution of interfacial conductance requires the maintenance of a high reproducibility of sample preparation and measurement. In addition to the measurement of the streaming potential (or the streaming current), the differential pressure, and the electrolyte conductivity and temperature for calculating the zeta potential according to Eq. (9.4), other parameters describing the flow behaviour of measuring liquid streaming through the permeable fibre plug, and the electrical conductance of the fibre sample are extremely helpful for achieving this goal.

Appendix: symbols and abbreviations

Notation

A	cross-section of flow channel
B	phenomenological parameter of Chang-Robertson approach for calculating zeta potential of fibre plugs
d	packing density of fibre or powder plug in the measuring cell
$dI/d\Delta p$	streaming current coupling coefficient (slope of streaming current vs. differential pressure)
$dU/d\Delta p$	streaming potential coupling coefficient (slope of streaming potential vs. differential pressure)
I, I_{Str}	streaming current
I_{back}	backflow current opposing the streaming current
k	rate of swelling of natural fibres
L	length of flow channel
$L/A, L_{cell}/A_{cell}$	cell constant of flow channel
R	electrical resistance inside measuring cell
$R_{0.1\text{ N KCl}}$	electrical resistance inside measuring cell when using 0.1 N KCl
t	time
U, U_{Str}	streaming potential
Δp	pressure difference across the flow channel
ϵ	dielectric coefficient of electrolyte solution
ϵ_0	vacuum permittivity
ζ	zeta potential
ζ_0	zeta potential of natural fibres at first contact with water
ζ_{EQ}	equilibrium zeta potential for completely swollen natural fibres
η	dynamic viscosity of electrolyte solution
κ	electrical conductivity
$\kappa_{0.1\text{ N KCl}}$	electrical conductivity of 0.1 N KCl
κ_B	bulk conductivity of electrolyte solution
σ_{el}	electrokinetic charge density

Abbreviations

APTES	aminopropyl triethoxy silane
N-CPC	<i>N</i> -cetyl pyridinium chloride
EDL	electrochemical double layer
iep	isoelectric point
pcr	point of charge reversal
PET	poly(ethylene terephthalate)
PMMA	poly(methyl methacrylate)
PTFE	poly(tetrafluoro ethylene)
pzc	point of zero charge
VTS	vinyl triethoxy silane

References

- AFG Analytic. FPA Fiber Potential Analyzer, 2018. Available at: <https://www.afg-analytic.de/en/fpa-fiber-potential-analyzer.html>.
- Anton Paar, GmbH, 2003. EKA Electro Kinetic Analyzer Instruction Manual. Anton Paar GmbH, Graz.
- Anton Paar GmbH, 2009. Instruction Manual SurPASS Electrokinetic Analyzer. Anton Paar GmbH, Graz.
- Aranberri-Askargorta, I., Lampke, T., Bismarck, A., 2003. Wetting behaviour of flax fibers as reinforcement for polypropylene. *J. Colloid Interface Sci.* 263, 580–589.
- Baltazar-y-Jimenez, A., Bismarck, A., 2007. Wetting behaviour, moisture uptake and electrokinetic properties of lignocellulosic fibres. *Cellulose* 14, 115–127.
- Bellmann, C., Caspari, A., Albrecht, V., Loan Doan, T.T., Mäder, E., Luxbacher, T., Kohl, R., 2005. Electrokinetic properties of natural fibres. *Colloid. Surf. A Physicochem. Eng. Asp.* 267, 19–23.
- Bismarck, A., Mohanty, A.K., Aranberri-Askargorta, I., Czaplá, S., Misra, M., Hinrichsen, G., Springer, J., 2001. Surface characterization of natural fibers; surface properties and the water uptake behaviour of modified sisal and coir fibers. *Green Chem.* 3, 100–107.
- Bismarck, A., Aranberri-Askargorta, I., Springer, J., Lampke, T., Wielage, B., Stamboulis, A., Shenderovich, I., Limbach, H.-H., 2002. Surface characterization of flax, hemp and cellulose fibers: surface properties and the water uptake behavior. *Polym. Compos.* 23, 872–894.
- BTG, 2018. Müték SZP-10 System Zeta Potential. Available at: <https://www.btg.com/en/products/products-by-type/laboratory/laboratory-detail/178/>.
- Chang, M.Y., Robertson, A.A., 1967. Zeta potential measurement of fibres: D.-c. streaming current method. *Can. J. Chem. Eng.* 45, 66–71.
- Colloidal Dynamics, LLC, 2018. How do the Zetaprobe and Acoustosizer II measure zeta potential and particle size? Available at: http://www.colloidal-dynamics.com/docs/CD_measurement_techniques.pdf.
- Delgado, A.V., Gonzalez-Caballero, F., Hunter, R.J., Koopal, L.K., Lyklema, J., 2005. Measurement and interpretation of electrokinetic phenomena. *Pure Appl. Chem.* 77, 1753–1805.
- Dispersion Technology, Inc., 2018. Short introduction to electroacoustic theory. Available at: <https://www.dispersion.com/electro-acoustic-theory-short-introduction-and-references>.
- Espinosa-Jimenez, M., Gonzalez-Caballero, F., 1991. The electrokinetic properties of cellulose fabrics and their significance in dyeing processes. *Cellul. Chem. Technol.* 52, 65–77.
- Eureka, 2010. Project 4178, 'Improving the Application and Durability of Surface Functionalisation on Textile Fabrics'. Available at: <http://www.eurekanetwork.org/project/-/id/4178>.
- Fairbrother, F., Mastin, H., 1924. Studies in electro-endosmosis. Part I. *J. Chem. Soc.* 75, 2318–2331.
- Gonzalez-Caballero, F., Espinosa-Jimenez, M., Gonzalez-Fernandez, C.F., 1988. The uptake of a reactive dye by bleached cotton and its effect on the electrical properties of the interface. *J. Colloid Interface Sci.* 123, 537–543.
- Goring, D.A.I., Mason, S.G., 1950a. Electrokinetic properties of cellulose fibers. I: stream potential and electro-osmosis. *Can. J. Res. B* 28, 307–322.
- Goring, D.A.I., Mason, S.G., 1950b. Electrokinetic properties of cellulose fibers. II: zeta-potential measurements by the stream-compression method. *Can. J. Res. B* 28, 323–338.

- Hubbe, M.A., 2006. Sensing the electrokinetic potential of cellulosic fiber surfaces. *Bio-Resources* 1, 116–149.
- Hunter, R.J., 1981. *Zeta Potential in Colloid Science*. Academic Press, London.
- Hunter, R.J., 2001. *Foundations of Colloid Science*. Oxford University Press, New York.
- Inglesby, M.K., Gray, G.M., Wood, D.F., Gregorski, K.S., Robertson, R.G., Sabellano, G.P., 2005. Surface characterization of untreated and solvent-extracted rice straw. *Colloids Surf. B Biointerfaces* 43, 83–94.
- ISO 105-F09:2009 – Textiles – Tests for colour fastness – Part F09: Specification for cotton rubbing cloth.
- ISO 13099-2:2012 – Colloidal systems – Methods for zeta potential determination – Part 2: Optical methods.
- Jachowicz, J., Berthiaume, M., Garcia, M., 1985. The effect of the amphiprotic nature of human hair keratin on the adsorption of high charge density cationic polyelectrolytes. *Colloid Polym. Sci.* 263, 847–858.
- Jachowicz, J., Berthiaume, M., 1989. Heterocoagulation of silicon emulsions on keratin fibers. *J. Colloid Interface Sci.* 133, 118–134.
- Jachowicz, J., Maxey, S., Williams, C., 1993. Sorption/desorption of ions by dynamic electrokinetic and permeability analysis of fiber plugs. *Langmuir* 9, 3085–3092.
- Jacobasch, H.-J., Bauböck, G., Schurz, J., 1985. Problems and results of zeta-potential measurements on fibers. *Colloid Polym. Sci.* 263, 3–24.
- Kanamaru, K., 1960. Wasseraufnahme in ihrer Beziehung zur zeitlichen Erniedrigung des Zeta-Potentials von Fasern in Wasser. *Kolloid Z* 168, 115–121.
- Kühn, N., Jacobasch, H.-J., 1986. Zum Zusammenhang zwischen dem Kontaktwinkel zwischen Wasser und festen Polymeren und ihrem Zeta-Potential gegenüber wäßrigen Lösungen. *Acta Polym.* 37, 394–396.
- Luxbacher, T., Pusic, T., Petrinic, I., 2008. Monitoring the washing efficiency of stained cotton fabrics by streaming potential measurement. In: Dragcevic, Z. (Ed.), *Proceedings of the 4th International Textile, Clothing & Design Conference*. University of Zagreb, Croatia, pp. 825–830.
- Luxbacher, T., 2014. *The ZETA Guide – principles of the streaming potential technique*. Anton Paar GmbH, Graz.
- Luxbacher, T., 2018a. System for determining the zeta potential for characterizing a solid/liquid interface with controlled profile pressure loading. US 9,933,377 B2.
- Luxbacher, T., 2018b. Standard cotton fabric as a reference material for the streaming potential measurement. In: *Proceedings of the 9th International Textile, Clothing & Design Conference*, Dragcevic Z. University of Zagreb, Croatia, pp. 126–131.
- Lyklema, J., 1995. *Fundamentals of Interface and Colloid Science*, vol. 2. Academic Press, London.
- Matsumoto, H., Yako, H., Minagawa, M., Tanioka, A., 2007. Characterization of chitosan nanofiber fabric by electrospray deposition: electrokinetic and adsorption behavior. *J. Colloid Interface Sci.* 310, 678–681.
- Onabe, F., 1978. Studies on interfacial properties of polyelectrolyte-cellulose systems. I: formation and structure of adsorbed layers of cationic polyelectrolyte-(poly-DADMAC) on cellulose fibers. *J. Appl. Polym. Sci.* 22, 3495–3510.

- Onabe, F., 1979a. Studies on interfacial properties of polyelectrolyte-cellulose systems. II: electrokinetic properties of cellulose fibers with adsorbed monolayers of cationic polyelectrolyte. *J. Appl. Polym. Sci.* 23, 2909–2922.
- Onabe, F., 1979b. Studies on interfacial properties of polyelectrolyte-cellulose systems. III: theoretical model for the electrokinetic behaviour of cellulose fibers with adsorbed monolayers of cationic polyelectrolyte. *J. Appl. Polym. Sci.* 23, 2999–3016.
- Onabe, F., 1979c. Studies on interfacial properties of polyelectrolyte-cellulose systems. IV: electrokinetic properties of carboxymethylcellulose fibers with adsorbed multilayers of cationic polyelectrolyte. *J. Appl. Polym. Sci.* 24, 1629–1641.
- Parreira, H.C., 1980. On the isoelectric point of human hair. *J. Colloid Interface Sci.* 75, 212–217.
- Payerl, C., Bracic, M., Zankel, A., Fischer, W.J., Kaschowitz, M., Fröhlich, E., Kargl, R., Stelzer, F., Sprik, S., 2017. Nonspecific protein adsorption on cationically modified Lyocell fibers monitored by zeta potential measurements. *Carbohydrate Polymers* 164, 49–56.
- Plonka, R., Mäder, E., Gao, S.L., Bellmann, C., Dutschk, V., Zhandarov, S., 2004. Adhesion of epoxy/glass fibre composites influenced by aging effects on sizings. *Compos. A* 35, 1207–1216.
- Pothan, L.A., Bellmann, C., Kailas, L., Thomas, S., 2002. Influence of chemical treatments on the electrokinetic properties of cellulose fibres. *J. Adhes. Sci. Technol.* 16, 157–178.
- Pusic, T., Grancaric, A.M., Soljacic, I., Ribitsch, V., 1999. The effect of mercerisation on the electrokinetic potential of cotton. *J. Soc. Dye. Colourists* 115, 121–124.
- Pusic, T., Soljacic, I., Petrinic, I., Luxbacher, T., 2011. Microcapsule durability on polyamide-knitted fabrics assessed by streaming potential analysis. *AATCC Review* 11, 68–73.
- Ramesh Kumar, A., Teli, M.D., 2007. Electrokinetic studies of modified cellulosic fibres. *Colloid. Surf. A Physicochem. Eng. Asp.* 301, 462–468.
- Ribitsch, V., Stana-Kleinschek, K., Jeler, S., 1996. The influence of classical and enzymatic treatment on the surface charge of cellulose fibres. *Colloid Polym. Sci.* 274, 388–394.
- Ribitsch, V., Stana-Kleinschek, K., Kreze, T., Strnad, S., 2001. The significance of surface charge and structure on the accessibility of cellulose fibres. *Macromol. Mater. Eng.* 286, 648–654.
- Ristic, T., Hribernik, S., Fras-Zemljic, L., 2015. Electrokinetic properties of fibres functionalised by chitosan and chitosan nanoparticles. *Cellulose* 22, 3811–3823.
- Smoluchowski, M., 1905. Zur Theorie der elektrischen Kataphorese und der Oberflächenleitung. *Physikalische Zeitschrift* 6, 529–531.
- Stana-Kleinschek, K., Ribitsch, V., 1998. Electrokinetic properties of processed fibers. *Colloid. Surf. A Physicochem. Eng. Asp.* 140, 127–138.
- Stana-Kleinschek, K., Kreze, T., Ribitsch, V., Strnad, S., 2001. Reactivity and electrokinetic properties of different types of regenerated cellulose fibres. *Colloid. Surf. A Physicochem. Eng. Asp.* 195, 275–284.
- Stana-Kleinschek, K., Ribitsch, V., Kreze, T., Fras, L., 2002. Determination of the adsorption character of cellulose fibres using surface tension and surface charge. *Mater. Res. Innov.* 6, 13–18.
- Temmel, S., Kern, W., Luxbacher, T., 2005. Zeta potential of photochemically modified polymer surfaces. *Prog. Colloid Polym. Sci.* 132, 54–61.
- Wäsche, R., Naito, M., Hackley, V.A., 2002. Experimental study on the zeta potential and streaming potential of advanced ceramic powders. *Powder Technol.* 123, 275–281.

-
- Werner, C., Körber, H., Zimmermann, R., Dukhin, S., Jacobasch, H.J., 1998. Extended electrokinetic characterization of flat solid surfaces. *J. Colloid Interface Sci.* 208, 329–346.
- Zembala, M., Adamczyk, Z., 2000. Measurements of streaming potential for mica covered by colloid particles. *Langmuir* 16, 1593–1601.
- Zimmermann, R., Freudenberg, U., Schweiß, R., Küttner, D., Werner, C., 2010. Hydroxide and hydronium ion adsorption – a survey. *Current Opinion in Colloid & Interface Science* 15, 196–202.

This page intentionally left blank

Improving the flame retardancy of natural fibres

10

Ryszard M. Kozłowski¹, Małgorzata Muzyczek²

¹Journal of Natural Fibers Editor-in-chief, coordinator of FAO/SCORENA European Cooperative Research Network on Flax and other Bast Plants, former director of the Institute of Natural Fibres, Poznan, Poland; ²Journal of Natural Fibers Taylor & Francis Group, Poznan, Poland

10.1 Introduction

Most of the materials around us are flammable: they ignite easily with fast flame spread, and are linked to very dangerous fires leading to huge material loss and fatal accidents. Protecting flammable materials against fire is thus of the utmost importance. Textile materials are widely used and are often accidentally exposed to fire. Therefore, requirements are in place that force textile producers to modify their products so that they are flame retardant (FR) and difficult to ignite. These requirements are not only essential in health and safety terms, but also for economic reasons.

The most common natural fibres generally fall into two broad categories: lignocellulosic fibres such as cotton and flax, hemp, jute, sisal, ramie, abaca which are easy to ignite and flammable, and protein fibres such as wool, silk and leather, hair which are more difficult to ignite.

The flammability and flame retardancy of these natural fibre materials is therefore the subject of a considerable body of research.

10.1.1 Historical background

Fire retardants have been used for lignocellulosic materials for quite a long time. The first reports on the flammability and flame retardancy of natural fibres concerned wood, which was the most popular lignocellulosic material at the time and was widely used by our ancestors as a construction material.

Below some interesting data are presented on the historical use of flame retardancy of natural fibres: (Kozłowski and Helwig, 1998a)

- *1st century AD* – During the reconstruction after the Great Fire of Rome, Emperor Nero ordered wood to be soaked in salt water before use.
- *1638* – fire retardant treatment for canvas was used in Persian theatres.
- *1684* – report on Oxford written on a piece of ‘incombustible cloth’.
- *1783* – coating of a lighter-than-air balloon with alum by the Montgolfier brothers to reduce fire hazard.

- *18th–19th centuries* – the first experiments with inorganic salts, leading to basic understanding of fire retardants and their protective mechanisms, carried out by William Henry Perkin and Gay-Lussac.
- *World War II* – considerable progress in fire retardants for textiles and wooden products for military purposes.

The search for FRs for cellulosic fabrics has an interesting historical background and the records go back over 350 years. As mentioned above, after a great fire in Paris in 1821, Gay-Lussac advised the use of the simple salts ammonium chloride (NH_4Cl) and diammonium phosphate ($(\text{NH}_4)_2\text{HPO}_4$) to render wood and other lignocellulosic materials fire retardant. Later, researchers took other inorganic salts into consideration such as boric acid and borates, chlorides of calcium, magnesium, zinc and tin, sodium silicate, aluminium hydroxide and calcium sulphate. Gay-Lussac was also asked by King Louis XVII to look for means of protecting fabrics used in the theatre after previous fires in European playhouses. Gay-Lussac recommended for these purposes chemical compounds such as ammonium salts of sulphuric, hydrochloric or phosphoric acid for the treatment of hemp and linen fabric. He observed that a better result could be obtained by using a mixture of ammonium chloride and ammonium phosphate. He also noticed that borax did not prevent afterglow but was very effective when mixed with ammonium chloride.

The renowned chemist William Henry Perkin became interested in the problem of flame retardancy at the beginning of the 20th century and conducted a series of studies. Perkin defined the requirements for a flame proofing process in terms that are as relevant today as they were in 1913. These requirements are listed below: A process, to be successful, must in first place not damage the feel or durability of the cloth or cause it to go damp as so many chemicals do, and it must not make it dusty.

It must not affect the colours or the design woven into the cloth or dyed or printed upon it; nothing (such as arsenic, antimony or lead) of a poisonous nature or in any way deleterious to the skin may be used and the fireproofing must be permanent, that is to say, it must not be removed even in case of a garment which may possibly be washed 50 times or more. Furthermore in order that it may have a wide application, the process must be cheap (Kandola, 1996).

Perkin's work confirmed the results obtained by Gay-Lussac and others and initiated a commercial process called 'Non-flame'. In this process, flannelette was first impregnated with sodium stannate and then with ammonium sulphate, followed by washing and drying. The retardant is believed to be a stannic oxide that reacts with cellulose in such a way as to produce permanent resistance to laundering with soap.

This work has withstood the scrutiny of subsequent researchers for 150 years and remains valid and applicable today. However, Perkin's process did not prove popular at the time, and no further developments in FRs were carried out until World War II.

The properties required today in an ideal fire retardant are: (Kozłowski and Helwig, 1998a)

- high fire protection effectiveness,
- chemical stability when subjected to fire,
- no effect on mechanical strength and aesthetics of protected materials,
- no emission of toxic and corrosive substances during their use – low bioavailability,

- no increase in emissions of toxic and corrosive gases produced by thermal decomposition and combustion,
- easy to apply,
- insecticidal and fungicidal effectiveness if possible,
- resistance to water,
- relatively low price.

It is very difficult to meet all the requirements listed above when using only one fire retardant. Fire retardant systems therefore frequently consist of multiple components. These requirements do not differ substantially from those defined by Perkin, although they are now more numerous.

Typically, flame retardants contain one of the following seven elements: chlorine, bromine (both halogens), aluminium, boron, nitrogen, phosphorus or antimony. There are, however, a number of replacement and synergists that have also been shown to be effective. For example, aluminium, which is most often used as an oxide or hydroxide, can be replaced by magnesium hydroxide or by magnesium salt. Also, some elements, such as zinc, often used as zinc borate or zinc stannate, and molybdenum, often used as ammonium molybdates, have also been found to be effective, primarily as smoke suppressants in mixtures of flame retardants (Posner, 2009).

One problem that is currently receiving a great deal of attention is the emission of the toxic products of thermal decomposition and combustion of materials as well as smoke release. The literature shows that 55%–70% of fire victims die as a result of inhalation of gases produced by decomposition and combustion of materials and not from the direct action of high temperature and flame.

The American Fire Safety Council (Arens, 2004) states that the United States has one of the highest rates of fire deaths and injuries in the world.

For example, (Evarts, 2018)

- Fire death rates vary considerably by state, with 2012–16 average death rates per million population ranging from a low of 3.9 to a high of 24.4.
- The US average was 9.7 deaths per million population.
- Public fire departments responded to 1,319,500 fires in 2017, a slight decrease of 2% from the previous year (Fig. 10.1).
- Every 24 s, a fire department in the United States responds to a fire somewhere in the nation.
- A fire occurs in a structure at the rate of one every 63 s, and a home fire occurs every 88 s.
- 77% of all fire deaths occurred in the home, a decrease of 4% compared to 2016.
- Home fires were responsible for 10,600 civilian injuries, or 72% of all civilian injuries, in 2017.
- An estimated \$23 billion in property damage occurred as a result of fire in 2017, a large increase, as this number includes a \$10 billion loss in wildfires in Northern California.
- An estimated 22,500 structure fires were intentionally set in 2017, an increase of 13% over the year before (Fig. 10.1).

Domestic fire safety in Europe: (Kobes et al., 2009)

- In Europe 2.0–2.5 million fires are reported per year, resulting in 20,000–25,000 fire deaths and 250,000–500,000 fire injuries in Europe per year (CTIF, 2006).
- About 80% of the fatalities occur in private homes. Fire safety regulations cover residential buildings with respect to constructional fire safety. The interior, however, of the homes (in

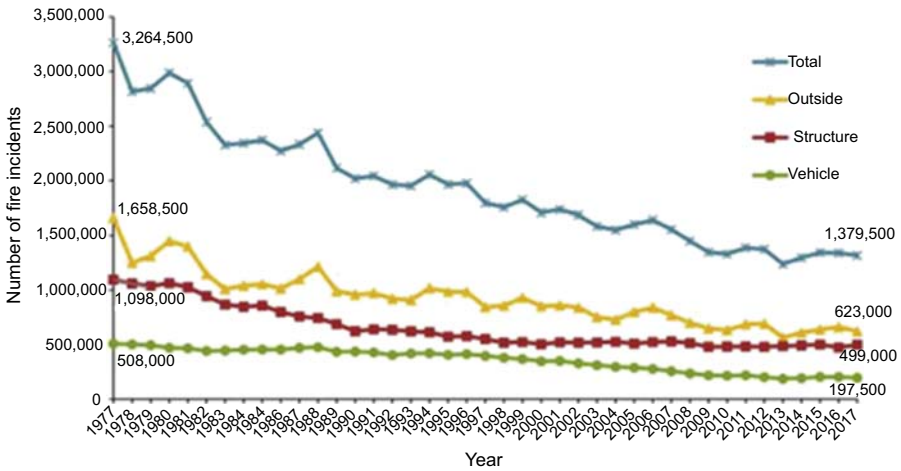

Figure 10.1 Fires in the United States during 2017 by type.

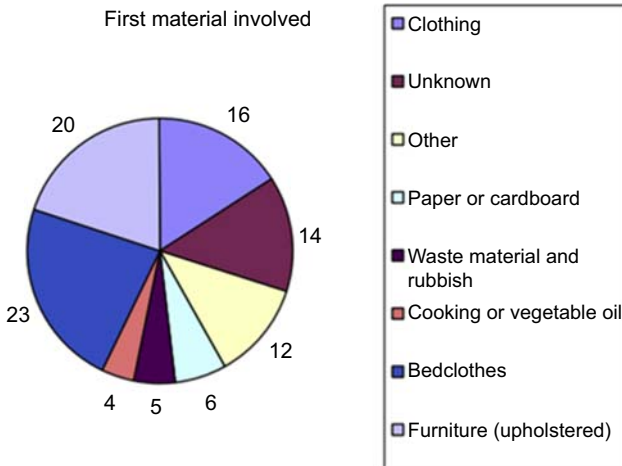

Figure 10.2 First material involved in (start of) domestic fire.

contrast to most commercial buildings) is full of materials that can easily be ignited and contribute to the fast spreading of fire (Fig. 10.2). This area has been widely neglected in consumer protection legislation in Europe.

- The (absolute) number of fatalities is relatively high in Poland, the United Kingdom, France and Germany; however, compared to the other EU countries the number of fire deaths per million inhabitants is not extremely high in these four countries.
- The number of fire deaths per million inhabitants is relatively high in Latvia (58.7), Estonia (54.0) and Lithuania (52.4). The number of fire deaths per million inhabitants is relatively low for the Netherlands (4.3), Germany (5.3) and Austria (5.5). The average fire death ratio is 17.3 for the 18 EU countries studied.

10.1.2 Flame retardant (FR) market (Wilkie et al., 2009)

Worldwide consumption of flame retardants reached a volume of 2.49 million tonnes in 2015 valued at US\$6.29 billion. In volume terms, market size is expected to grow at a compound annual growth rate (CAGR) of 4.9% from 2016 to 2025 to exceed 4.0 million tonnes by the end of the forecast period. In terms of value, the global flame retardants market is predicted to touch US\$11.96 billion by 2025. Flame retardants are mainly consumed by the polymer industry. Textiles and rubber products account for most of the rest (Additives for Polymers, 2017).

Fig. 10.3. shows the consumption of FRs by region (2016).

Asia consumed the largest volume of flame retardants in 2016 with a 50% share, with China being the largest single consumer at 26% (<https://www.flameretardan>).

China has recently become a key player in the field of FR textiles for many reasons. The most widely used FRs are antimony oxide, phosphorus and bromine, all of which are produced in China, where the prices of these FR substances are lower than those of other global producers. China has a large number of phosphorus furnaces in operation, and thus produces elemental phosphorus, reportedly in the range of one million metric tons/year, most of which is used in fertilizers. Phosphorus trichloride, phosphorus oxychloride and phosphine-derived THPC or THPS are also produced in China. Furthermore, antimony oxide has been rising rather sharply in price, making phosphorus even more important as an FR.

It is worth mentioning that China is not only a large exporter of FRs but also a large domestic consumer of FRs, including FRs for textiles. The statistics for China show that there has been a slight increase in the rate of casualties from fire, and the contribution of textile materials to the risk of fire has certainly been recognized (Weil and Yang, 2008).

Fig. 10.4 shows the classes and share of commonly used FRs in the world and Table 10.1 presents the US flame retardant market (Dawson et al., 2004).

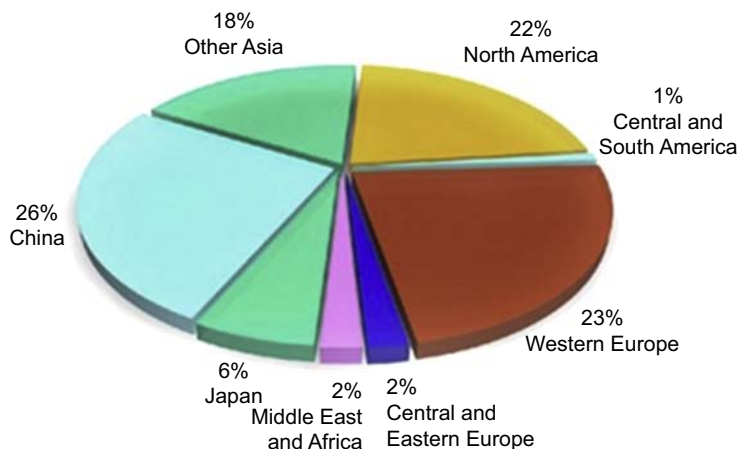

Figure 10.3 Global Flame Retardants Consumption by region, 2016

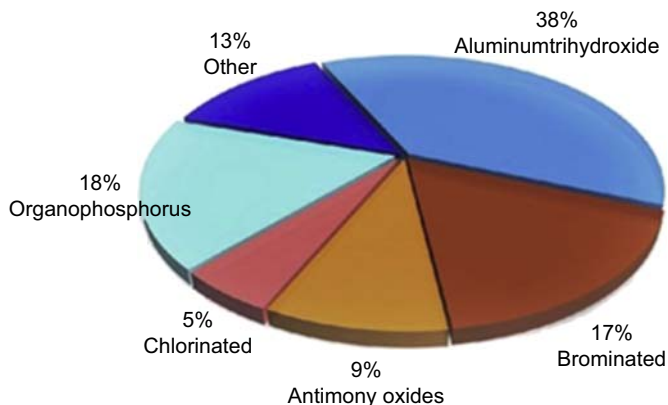

Figure 10.4 Global Flame Retardants Market by chemistry, 2016.

Table 10.1 US flame retardant market (Dawson et al., 2004).

Chemical type	Market share (%)
Bromine-based	32
Chlorine-based	17
Phosphorus-based	17
Antimony oxide	20
Alumina trihydrate	11
Other (includes magnesium hydroxide and boron-, molybdenum- and nitrogen-based)	3

Aluminium hydroxide is the largest single flame retardant at 38% share. Second are the halogenated flame retardant systems comprising brominated and chlorinated products which are commonly used together with the synergist antimony trioxide, in total 31%. Organophosphorus and other flame retardants like e.g. inorganic phosphorus compounds, nitrogen and zinc based flame retardants make up the rest at 31%.

Over the last decade there is a trend towards substituting legacy halogenated flame retardants with more sustainable non-halogenated products (<https://www.flameretardan>).

Nowadays, the increasing concentrations of the structurally related polybrominated diphenyl ethers (PBDEs) in the environment, human food chain, and human tissues raise concern about possible neurotoxic effects. PBDEs are used as flame retardants in a range of products, including electronic equipment, furniture, construction materials, and textiles. As Milou M.L. Dingemans (2007), is that children of early brain age accumulate BDE-47 (tetrabromodiphenyl ether) more rapidly than adults.

Neonatal exposure to brominated flame retardant reduces long-term potentiation and postsynaptic protein levels in mouse hippocampus.

Also other example: The US Congress is considering legislation to lift requirements for airports to use firefighting foams containing fluorochemicals. Substances such as perfluoroalkyls persist in the environment and are increasingly found in drinking water supplies across the United States, especially near airports, military bases, and other facilities that manufacture or use these compounds. Foams containing fluorochemicals have been used for decades to suppress fires involving hydrocarbon fuels. Now, a bill (H. R. 4) that the House of Representatives passed in late April 2018 to reauthorize the Federal Aviation Administration says FAA ‘shall not require the use of fluorinated chemicals’ in firefighting foams used at airports (Hogue, 2018).

The non-halogenated flame retardant report is categorized based on key polymers such as epoxy resin, PVC, unsaturated polyester, UPE, rubber, polyolefin, Engineering Thermoplastic (ETP), styrenics and others (polyurethane, synthetic fibers, etc.) (Transparency Market Research). Transportation, textile, construction, electrical and electronics, furniture, among others are some of the major applications-see Table 10.2 Market applications.

Certain issues in functional properties like loading levels and setbacks in cognitive operations of non-halogenated flame retardants are growth restraining factors expected to hinder the market growth in the coming years. In many cases replacing used flame retardants by micro- and nanoparticles has also influence in decreasing amount of flame retardants.

The role of FRs is to provide fibres and textiles that are flame resistant by increasing their ignition temperature and modifying their reaction to fire. Each of these markets for FRs is driven by different demands for reaction or resistance to fire (Innes, 1996).

Particularly in case of man-made fibres it is desirable to avoid dripping and toxic activity of flame retardants (before and after burning).

Table 10.2 Market applications (Weil and Yang, 2008).

Market area	Products/places	FR philosophy
Building construction and contents	Building	(1) Containment
	Interior finishing	(2) Flame spread
	Furnishings	(3) Ignition resistance
Electrical and electronics	Small appliances	(1) Ignition
	Electronic devices	(2) Resistance
	Wire and cables	(3) Flame resistance
Transportation	Automotive	(1) Escape time
	Public transportation Rail	(2) Containment
	Aircraft	

10.2 Key issues in flame retardancy of natural fibres and lignocellulosic textiles

Generally most of textiles fibres are highly combustible except only protein fibres (wool, silk) and leather. The term 'combustible fibres' is intended to include the readily and freely burning fibres, commonly encountered in commerce, which are stored in relatively large quantities and when they are stored present considerable fire hazard.

Main causes of fire are:

- Faulty electrical equipment
- Foreign materials in storage fibres e.g. like metal, increasing temperature by fermentation in fibres with higher humidity, sometimes by spontaneous heating (oxidation reaction occurring with some fibres like jute, hemp, kenaf)
- Friction, fibres-to –fibres
- Smoking. (Merritt, 1954)

Charring fabrics, made from natural fibres such as cotton, wool exhibit a greater tendency to smoldering combustion and can be more susceptible to smoldering ignition (Posner, 2009).

As mentioned previously, while FRs are able to effectively lower the ignitability and heat release rate (HRR) of protected textiles, as well as reducing surface spread of flame, their contribution to the levels of toxic gases emitted by textiles at high temperatures or in fire conditions is often unknown: this issue is of increasing importance in the field.

An equally important issue is the elimination of toxic substances which could be harmful to the environment, including sewage waste, gases, fumes, dust and solid waste (Wesolek and Kozłowski, 2002). The development and introduction of no-waste technology, that is, full recycling in production and application, would be a step towards reducing these risks. The bioavailability of the FR to the human skin, especially for textiles used for apparel and linen bedding is also of great importance.

The US Environmental Protection Agency (EPA) has studied FRs with particular emphasis on the brominated groups and the hazard they pose to the environment (Hogue, 2010).

Research into fire retardants for lignocellulosic fibrous materials in textiles (such as cotton, flax, hemp, ramie, jute and kenaf) generally follows one of two paths: durable and non-durable.

For fibres and textiles that have to be washed, the objective is to find the most effective and durable fire retardant finishing. Durable flame retardancy is generally obtained through chemical modification involving chemical reactions between hydroxyl groups of cellulose with reactive fire retardant.

Cellulose is a polyhydroxy compound that may be modified by the formation of chemical derivatives through the typical reaction of alcohols: the substitution of hydroxyl groups.

However, the physical structure of natural cellulosic fibres, especially their crystalline regions, is linked to cellulose displaying reduced chemical reactivity. Its crystalline

structure renders the larger part of the molecule impenetrable by chemical reagents, so that the most important consideration in any reaction system is how to disrupt the crystalline regions so that they may become as accessible to reagents as the amorphous regions.

Pre-treatment processes are therefore required, which often result in the activation of cellulose. Cellulose may be activated by various processes involving treatment with water or aqueous solutions, which also cause the cellulose to swell. Sodium hydroxide and liquid ammonia are still important and are widely used for the process of mercerization and non-iron finishing of flax and other cellulosic fibre yarns.

From a chemical point of view, the chemical modification reaction involved in the functionalization of cellulose can be divided into the following processes:

- addition of water and alkalis,
- esterification – inorganic and organic,
- etherification,
- oxidation,
- other reactions such as halogenations, cold plasma and corona treatment, MOF, polyoxy metaletes and dendrimers – grafting, etc.

The latest advances in genetic engineering have created the opportunity to obtain transgenic cellulose (cotton, flax, sisal, etc.) with built-in FR groups inside the structure of cellulose or lignin. These can substitute hydroxyl groups, rendering cellulose more flame resistant in its natural state.

The flammability of different fibres depends on their chemical composition and structure. [Table 10.3](#) presents the flammability properties of some natural and man-made fibres for comparison purposes ([Wakelyn et al., 1998](#)).

In lignocellulosic fibres the main flammable element is carbon. The calorimetric efficiency of combustion of carbon sources is presented below:

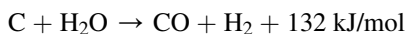
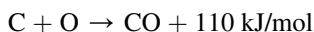
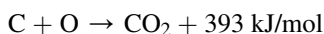

From these equations it can be observed that HRR (kJ/mol) is the highest in the case of full oxygen delivery in flame conditions. It is clear that FR materials emit a lower amount of flammable gases. [Table 10.4](#) presents the different mechanisms of fire retardancy, which are applicable for all materials including fibres and textiles.

The mechanism of combustion of lignocellulosic and other flammable materials, both protected and unprotected, is presented below – unprotected fibres in [Fig. 10.5](#) and protected fibres in [Fig. 10.6](#).

Table 10.3 Flammability properties of various fibres (Wakelyn et al., 1998).

Fibre type	Oxygen index – LOI according to ASTM/D-2863-70	Heat of combustion (kcal/kg)	Ignition temperature (°C)	Self-ignition temperature (°C)	Smoke emission		Gases produced in flaming conditions
					Decrease in visibility (m)	Optical density (%)	
Cotton	18.4	3.9	255	400	4	0.02	CO ₂ , CO, H ₂ O
Flax	17.4	3.8	256	390	4	0.02	CO ₂ , CO, H ₂ O
Wool	25.2	4.9	242	570–600	18	0.09	CO ₂ , CO, HCN, NO _x , H ₂ O
Rayon	19.7	3.9	420	500	4	0.02	CO ₂ , CO, HCN, NO _x , H ₂ O
Polyamide	20.1	7.9	421–485	530	6	0.03	CO ₂ , CO, HCN, NO _x , H ₂ O
Polyester	20.6	5.7	320	440	28	0.14	CO ₂ , CO, H ₂ O
Polyvinyl chloride	37.1	5.1	395	—	34	0.18	CO ₂ , CO, HCl, NO _x , H ₂ O
Polypropylene	18.6	6	340	570	66	0.39	CO ₂ , CO, H ₂ O
Polylactic acid (Hogue)	22.0	—	—	—	—	—	—

ASTM, American Society for Testing and Materials; LOI, limiting oxygen index.

Table 10.4 Mechanism of fire retardancy (Kozłowski et al., 2001).

Mechanism	Compounds and agents	Comments
<p>1. Generation of protective gaseous coatings of non-flammable gases at elevated temperatures.</p> <p>Inhibition of combustion by terminating the formation of free radicals in chain reactions proceeding in burning gases. Capability of building a group into the structure that is converted into fire-retardant form.</p> <p>Removing of hydrogen from flammable fibres in fire conditions.</p>	<p>Ammonium compounds, halogen compounds, sulphates, organic halogen derivatives, for instance derivatives of 4-bromophthalic acid, HET acid.</p> <p>The halogen effect increases when halogen combines with a metal oxide (e.g. antimony (III) oxide) due to synergic effect.</p>	<p>Advantages: effective protection against flame spreading, easily applicable.</p> <p>Disadvantages: easily leached, generally (except for organic derivatives) poor stability, abundant evolution of toxic gases during combustion.</p>
<p>2. Retardation of temperature increase of flammable materials, for example lignocellulosic particles, due to high heat of melting and decomposition and the ability to be converted at flame temperature into non-flammable liquid forms which cut off oxygen supply.</p>	<p>Boron compounds (boric acid, borax, zinc borate, methyl and ethyl borates), polyphosphates, tungstic acid, phosphonic derivatives, aluminium phosphate, molybdenum oxides.</p>	<p>Advantages: very effective protection due to increase in material ignition temperature. Decrease of emitted heat energy.</p> <p>Disadvantages: phosphate-based fire retardants have considerable influence on mechanical properties of materials and cause increased emission of CO by catalyzing combustion reaction towards the formation of this toxic gas.</p>
<p>3. Activity that comprises properties of the above-mentioned groups.</p>	<p>Ammonium phosphates, ammonium polyphosphates, ammonium borates, phosphate adducts with urea, melamine, biuret, dicyandiamide, etc., ammonium molybdate in combination with hydrated alumina, proteins.</p>	<p>Advantages: the most advantageous and versatile action.</p> <p>Disadvantages: easily leached out, emission of great amounts of toxic gases, especially in the case of phosphate-containing systems.</p>

Continued

Table 10.4 Continued

Mechanism	Compounds and agents	Comments
4. Reduction in thermal conductivity, resistance to fire.	Blending the natural fibres with Mineral fibres: (alumina fibres, glass fibre, mineral wool), granulated glass, kaolin, diatomite, mica and its derivatives (vermiculite), also covered with silver, carbon fibres, synthetic fibres based on polymers NOMEX, Kevlar, also including 'ladder' polymers suitable for back coating of textiles (carpets, etc.).	Advantages: significant improvement of insulating ability and improvement of partitions. Introduced products cause a decrease in the emission of toxic gases. Disadvantages: they are not suitable for many lignocellulosic fibres protection. They accumulate heat generated during fire, which results in temperature increase.
5. Insulating of lignocellulose material against penetration of heat energy. Screening and reflecting of heat radiation.	Acting as Mirrors of Al and Ag foil reflecting IR, intumescent coatings including the most recent solution: flexible intumescent interlayer, montmorillonite incalate fire blockers (for special applications, e.g. aircraft interiors, heritage buildings). see Fig. 10.7	Advantages: ready to use, relatively low cost of protection, complete inhibition of fire spreading over the surface, separation of flammable materials from fire zone. Disadvantages: protection of surface only; in case of surface damage, there is a fire hazard. In the case of textile composites, cover the natural design and colour.

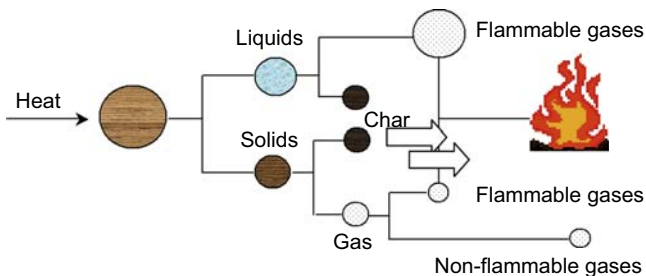

Figure 10.5 Burning mechanism of untreated lignocellulosic fibres.

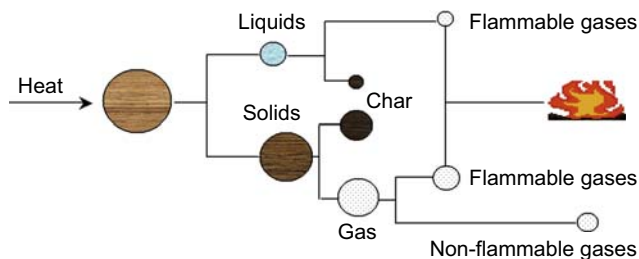

Figure 10.6 Burning mechanism of FR treated lignocellulosic fibres.

Phosphorus–nitrogen synergism is a real effect in some specific cases but cannot be considered to be universal. It can most clearly be observed with phosphorus FR finishes on cellulosic substrates. In this case, its occurrence is dependent upon the nitrogen compound used, and probably results from the formation of reactive P–N intermediates. In other cases, nitrogen components can actually provoke the action of phosphorus FRs. When this occurs, it is probably the result of neutralizing or buffering phosphorus acids.

Some stable covalently bonded P–N inorganics appear to be useful FRs despite their extremely high thermal and hydrolytic stability (Weil et al., 1993).

Melamine can prove useful in the development of FRs, and can even synergize phosphorus with or without chemical interaction. The endothermic sublimation and dissociation of melamine alone probably make major contributions to its FR effect. Melamine phosphates are broadly effective FRs, with melamine cyanurate and melamine borate also proving very effective. They display a synergistic effect with pentaerythritol and ammonium polyphosphate (Bolens et al., 1999).

In addition to the release of melamine, the mode of action of these substances, particularly dimelamine phosphate, involves condensation reactions of both the melamine and the phosphate portion of the molecule. The end product appears to be phosphorus oxynitride which itself offers very promising FR properties.

Indirect evidence suggests that phosphorus oxynitrides may occur in char from P–N systems, but direct evidence of this is not yet available.

FR chemicals prevent the release of volatile products by forming a glassy barrier. This barrier also prevents oxygen from accessing the pyrolysis zone. FR chemicals may increase the thermal conductivity of fibres in order to dissipate the heat from the surface faster than it is supplied by the external heat source, or they may affect chemical and physical changes so that heat is absorbed by chemicals, preventing the surface from igniting.

Non-flammable gases released by the decomposition of FR chemicals dilute the combustion gases formed by the pyrolysis of lignocellulosic fibrous materials and form a non-flammable gaseous mixture.

FR chemicals lower the temperature at which pyrolysis occurs, directing the degradation pathway towards more char production and fewer volatiles, and also release free radical inhibitors at pyrolysis temperatures that interrupt the chain propagation mechanism of flammability (Kozłowski and Helwig, 1998b).

The effects of FR application for fibres and textiles include:

- delay of ignition time,
- reduction of fire propagation,
- reduction of heat released,
- reduction of mass loss rate (MLR),
- reduction of surface spread of flame.

These effects make it possible to extinguish the fire, using simple equipment and with a longer time available for evacuation, etc.

Fire retardants can be classified according to their different characteristics. Types of fire retardants could be divided for different groups, e.g.:

- Chemical nature:
 - inorganic compounds,
 - organic compounds.
- Penetration:
 - penetrating treated material,
 - creating a protective coating on the surface (limited penetration).
- Application:
 - for structures (increasing fire resistance),
 - for decorative materials,
 - for furniture,
 - for outdoor elements,
 - for historic wooden buildings, etc.

10.3 Flammability and flame retardancy of some natural fibres and textiles

Because of differences in chemical composition between natural fibres, for example, cellulosic versus protein fibres, their fire behaviour is different. This requires special approach to fire retardancy of specific fibre types.

10.3.1 Cellulosic fibres

Cotton, viscose, acetate, triacetate, flax, linen, hemp, jute, sisal, ramie, abaca, cabuya and henequen, coir are fibres with low flame resistance, composed of carbon and hydrogen (fuels) and oxygen (which supports combustion). These fibres are consequently highly flammable.

The use of a Cone Calorimeter to determine the heat release rate from different textiles, including cotton, flax, and silk was investigated by Horrocks and others (Bolens et al., 1999), who concluded that:

The peak heat release rate (PHRR) value depends on time to peak (TTI), which in turn depends on ignitability of a specimen. Due to this dependency those two parameters have been combined into one index called FIGRA (Fire Growth Rate Index) which is the ratio of PHRR and the time at which PHRR occur and may be used to

Table 10.5 Summary of cone calorimetric data and ranking order of all the samples (van Hees et al., 2010).

Sample number	Cone calorimetric values				Ranking order of FIGRA values
	TTI (s)	PHRR (kW/m ²)	THR (MJ/m ²)	FIGRA (kW/m ² /s)	
Light cotton	9	94	1.0	9.40	3
Heavy cotton	14	128	3.2	9.10	2
Polyester/cotton	10	157	1.9	15.4	5
Acrylic	17	292	4.5	16.2	6
Light silk	—	—	—	—	0
Heavy silk	28	45	1.0	1.5	1
Wool	16	171	2.9	10.6	4

FIGRA, fire growth rate index; PHRR, peak heat release rate; THR, total heat released; TTI, time to ignition.

rank fabrics for their potential burning hazard [...] The higher is the FIGRA index value the higher is the fire hazard suggesting a high PHRR value at a very low time to ignite and so FIGRA in reality becomes a heat acceleration parameter.

Table 10.5 presents the results of cone calorimeter studies for different fibres, both man-made and natural, where FIGRA values were calculated at heat flow of 35 kW/m². Rank '0' suggests the safest fabric and rank '6' indicates the most hazardous fabric.

Cotton is an easily combustible fibre. Cotton fleece in particular has a lower density and contains a considerably large amount of air in its fuzzy surface; it is therefore more flammable than most woven and knitted cotton fabrics.

Without treatment by FRs it is very difficult to meet the flammability standard for cotton fabrics and apparel. Yung states that blending cotton with 10%–20% polyester slightly decreases the flammability of blended fabrics, but chemical treatment by FR is still required. However, blending cotton with polyester lowers the wearing performance of the fabric (Nazare et al., 2002).

Commonly used durable FR chemicals for cotton are based on organophosphorus compounds, such as tetrakis-(hydroxymethyl)-phosphonium chloride known as 'THPC'. The THPC system is effective in imparting durable flame resistance to cotton fabrics.

The use of THPC as an FR requires special equipment, making it unsuitable for most textile mills. *N*-methylol dimethylphosphonopropionamide (MDPA), commercially known as 'Pyrovatex CP' and 'Pyrovatex CP New', have also been used as an effective durable FR for cotton. Economic considerations and the use of formaldehyde for curing have led to a decrease in the level of cotton flame retardancy. For this reason, C. Q. Yang and others (Nazare et al., 2002) have investigated the use of polycarboxylic acids for

both cotton/polyester blends and 100% cotton. In that study, the authors (Yang and Qiu, 2006) developed an FR finishing system based on a combination of a hydroxyl-functional organophosphorus oligomer (HFPO) and dimethylol dihydroxyl ethylene urea (DMDHEU). DMDHEU as a bonding agent forms a covalent bond with cotton and cellulose and organophosphorus oligomer (HFPO). These two compounds are able to form a cross-linking network on cotton. Holme also discusses new trends in the development in chemical finishings for cellulose textiles using DMDHEU (Holme, 1993). Cotton fabric treated with this FR finishing system shows high levels of durable FR performance without significant change in fabric hand and whiteness.

Different halogen-free flame retardants based on different ratios of phosphorous-nitrogen containing monomers were developed by Ahmed el Shafei (Ahmed el Shafei, 2018) from North Carolina State University and grafted polymerized on PET, PP or cotton either thermally or using atmospheric glow discharge plasma. The key in the performance of monomers for self-extinguishing properties when graft polymerized thermally or via atmospheric plasma on cotton, polyester and polypropylene are the P/N ratio, % oxygen, and number of grafting sites.

As Zhang G. et al. (2018) reports a novel phosphorus-containing flame retardant, ammonium salt of triethanolamine phosphoric ester acid (ATEPEA) was facily synthesized under moderate and solvent-free conditions. The results showed that the ATEPEA flame retardant (FR) was successfully synthesized and grafted onto the cotton fabrics through P—O—C covalent bonds. The cotton fabrics treated with the ATEPEA have the excellent flame retardancy and durability. The limiting oxygen index (LOI) values of cotton fabrics treated with 200 and 250 g/L ATEPEA were 44.0% and 46.6%, respectively; even after 50 laundering cycles, the LOI values still had 26.2% and 27.2%, respectively. These results confirmed that the ATEPEA FR had high efficiency and conferred excellent durability on cotton fabrics.

Beginning in the 1960s Westex Inc. set out to produce flame resistant cotton fabrics for industrial uses by exploring PROBAN/FR — 7A. The resulting fabrics were certified flame resistant to industrial washes and 50 home launderings (Baitinger, 2002).

The durability of this FR is not connected to a chemical reaction between cellulose and phosphorus derivatives, but is a result of a curing process carried out in an ammonia atmosphere. PROBAN lowered the mechanical strength of fibres and resulted in higher levels of CO emission during combustion. This system is principally applied to all types of cotton work wear fabrics.

The durability of the flame resistance must be sufficient to survive industrial laundry conditions. The physical properties of the fabric have to yield acceptable performance both in the market and in the relevant working conditions.

Westex also introduced INDURA fabrics, with guaranteed flame resistance for all apparel. This product permits garment attrition, rather than a set number of washes, to become the criterion for removal from service. It also sufficiently enhances all cotton performance so that on a cost/performance basis it is effective. The durability of the flame resistance is achieved by applying specific finishing techniques. INDURA is still based on the ammonia-cure phosphonium salt precondensate system (Baitinger, 2002).

In 1970s, the United States Department of Agriculture developed a process that used boric acid to create flame resistant cotton batting. The application process has

now been improved such that boric acid no longer falls from the batting (Wakelyn et al., 2003). Ten percent by mass of boric acid is added to the raw cotton in the willow or mixing machine prior to ginning along with 2%–3% oil and the surfactant. The oil allows the dusting of boric acid to be avoided and makes it easier for the boric acid to adhere to the fibres. The oil is modified by the surfactant, reducing the surface tension on the fibres and improving the bond between boric acid and the fibres. The boric acid must be ground to a very fine particle size in order to improve adherence to the fibres.

Wakelyn et al. (2003) also present the idea of making the batting smoulder and flame resistant as well as durable to wet treatments through the use of an inherently flame resistant fibre such as Modacrylic or Basofil, which can be blended with the ‘cotton’ fibres with or without a low melt polyester. As a result, the various batting products can be produced for use as fire blocking barriers or as filling material.

Foster–Miller Inc. developed an innovative method of incorporating microencapsulated fire retardants (MFRs) into cotton and cotton blend tentage textiles (Kovar et al., 1994). Their efforts aimed at providing a new class of flame resistant textile fabric, using MFRs, which would meet the criteria of the fire retardant fabrics currently in use while also improving their fire performance by lowering smoke and heat generation, eliminating toxic gas generation and making them more ignition-resistant. They also aimed to reduce the overall cost of the coating.

The method developed by Foster–Miller Inc. involved sol–gel infiltration of alumina trihydrate FR and incorporation of intumescent FRs into MFRs, which would then be bonded to the fabrics using polyvinyl acetate latex, as both the micro-encapsulation layer and the adhesive for bonding the MFRs to the fabric. Alumina trihydrate, $\text{Al}_2\text{O}_3 \cdot 3\text{H}_2\text{O}$ is a known FR that extinguishes flame by emitting water when exposed to intense heat.

Sol–gel processing is a method of chemically synthesizing hydrated alumina from an alkoxysilane precursor such as aluminium tri-secondary butoxide. Alkoxides may be hydrated under aqueous conditions into a hydrated aluminium oxide and the corresponding alcohol (Wakelyn et al., 2003).

Vroman et al. (2005) provide information on the nano-encapsulation of ammonium phosphate as a fire retardant for textiles and also on the effect of surfactants on the properties of nano-capsules.

Summing up, flame retardancy of cotton and other lignocellulosic fibres (flax, hemp, jute, kenaf, abaca, sisal) is generally obtained by use of the following finishes.

1. Non-durable FR finishes:

- Phosphorous-containing compounds,
- Halogen-containing compounds,
- Inorganic compounds.

2. Durable FR finishes for cotton and other lignocellulosic fibres (flax, hemp, jute, sisal, ramie etc.):

- Propane (self-crosslinking),
- THPC,
- Ammonia,
- Pyrovatex CP (reactive to cellulose),
- MDPA,
- Trimethylol melamine (TMM).

3. Potential durable FR finishes for cotton fleece:
 - Organophosphorus chemicals,
 - HFPO,
 - Other chemicals,
 - Polycarboxylic acids,
 - Inorganic metal phosphates.
4. Binders for the HFPO:
 - Melamine—formaldehyde resin (TMM),
 - DMDHEU,
 - 1,2,3,4-butanetetracarboxylic acid (BTCA).
5. Other potential durable FR finishes for cotton: (Yang et al., 2006)
 - Multifunctional carboxylic acids,
 - Maleic acid,
 - Succinic acid,
 - Citric acid,
 - Inorganic phosphates,
 - $Al_a(OH)_b(HPO_4)_c(H_2PO_4)_dXH_2O$.

Another way to obtain low-inflammatory fabrics is the production of cotton blends with slow-burning fibers.

Mount Vernon Mills ([News from the World of Technical Textiles, 2016](#)), manufacturer of textile and chemicals has introduced its Resilience line of flame resistant fabrics engineered for enhanced durability. The new fabrics Arapaho R, Hopi N2X and Navajo N2X features cotton blended with high tenacity nylon or Kevlar for increased durability and higher abrasion resistance. Arapaho R, Hopi N2X and Navajo N2X fabrics contributes to more durable flame resistant clothing that doesn't sacrifice comfort.

10.3.2 Protein fibres

Wool and silk belong to this group, as they have nitrogen as part of their chemical composition. Nitrogen is non-flammable and does not support combustion, so these fibres ignite and burn much less easily. The development of a carbonaceous structure tends to inhibit flame.

The LOI for these protein fibres is above 25 without the use of an FR (see also [Table 10.3](#)).

10.3.2.1 Silk

Silk is a natural protein fibre and is viewed as environmentally friendly because it contains only natural amino acid units ([Guan and Chen, 2006](#)).

According to fire statistics about 50% of fires worldwide are caused by textiles. Silk is widely used to produce pyjamas, particularly in Asia, so it is important for silk fabrics to be finished with FR.

Silk generally has a higher flame retardancy than cellulosic fibres, which results from its high nitrogen content (about 15%–18%). Its LOI value is about 23%, but it still requires an additional FR finish to fulfil certain commercial requirements.

Two hundred years ago silk fabrics were immersed in a mixture of borax and boric acid solution to achieve FR finishing, but this mixture is easily removed in water. In the late 1960s, inorganic salts and quaternary ammonium salts were suggested as possible FRs for use on silk in Japan and America, but the most widely known commercial FR additive products were non-durable. In the mid-1980s a new method was developed, involving the treatment of silk fabrics with urea phosphoric acid salt using a pad dry process. This resulted in flame retardancy with an LOI value higher than 28%. The FR finish remained on the fabric after dry-cleaning but not after washing.

In the 1990s, the Japanese scientist Kako et al. investigated the treatment of silk fabrics with an organophosphorus FR and TMM (Yoshioka et al., 1990). The resulting fabric showed good flame retardancy. Recently there have been new reports on a study using *N*-hydroxymethyl (3-dimethyl phosphono) propionamide (HDPP, Pyrovatex CP, Ciba–Geigy) for the treatment of silk fabrics. In this case silk fabrics with excellent flame retardancy have been obtained.

Kamlangkla et al. (Richard Horrocks and Liu, 2015) report that diethyl 2-(acryloyloxyethyl) phosphate (DEAEP) and diethyl 2-(acryloyloxyethyl) phosphoramidate (DEAEPN) could be grafted on the surface of silk fabrics to enhance its flame retardancy by means of a two steps process, i.e., argon-induced graft polymerization of phosphorus containing monomers followed by a SF₆ plasma treatment.

The LOI of the treated fabrics reaches 29 and 30.5 vol% for DEAEP and DEAEPN, respectively, with a reasonable amount of loading (c. 11%).

10.3.2.2 Wool

Wool is a keratin protein composed of amino acids linked by a peptide bond. The peptide units are cross-linked by disulfide bonds, with reactive groups such as amino hydroxyl, imidazol and guanido attached to them (Kozłowski and Muzyczek, 1986).

The presence of potentially reactive groups in wool allows the modification of some of its properties. However, it must be emphasized that the cross-linked structure of keratin is not easily modified compared to that of other proteins, and in some cases modification is in fact impossible.

It is generally understood that wool, thanks to its high nitrogen content, shows significant resistance to the action of fire. Wool ignites with difficulty, has slow flame spread, and once the initial ignition is extinguished, it ceases to burn.

A comparative investigation of combustibility confirms the higher fire resistance of wool compared to other fibres. In many cases, when the fabric has a large surface mass (above 800 g/m²), wool is considered a non-combustible material. Woollen textiles, if exposed to a sufficiently intense heat source, can ignite, but in most cases they will only smoulder or carbonize rather than burning with flame.

Wool burns to ash, which cools immediately and can easily be removed from surfaces, including skin. In comparison with other fibres (mainly man-made fibres as PE, PP) the smoke released by burning wool is less dense. Thanks to its natural properties, wool is mostly used to produce clothes, furniture coverings, carpets and blankets. There has recently been an increased interest in the use of wool as a raw material with fire resistant properties, both in public buildings and for protective

clothing. This is the result of the natural fire resistance of wool combined with the possibility of achieving higher levels of protection through the use of fire retardants or by combining wool with other fire resistant fibres.

Treated FR wool may be used in the production of protective clothes for emergency situations (e.g. woollen protective clothing used by metalworkers, fire brigades, military forces and the petrol industry). Moreover, FR wool is used in the production of tapestries, floor coverings, carpets and other goods in hotels, restaurants, high buildings, aeroplanes and ships.

Wool blended with certain cellulosic fibres such as flax, hemp and jute has been described as non-flammable. In flame conditions, the wool in these blends reduces the crystalline area of the cellulosic fibres, creating an amorphous area and leading to lower flammability (Kozłowski et al., 2002, 2005a).

The International Wool Secretariat (CSIRO) achieved a notable scientific breakthrough with the discovery and development of a new mordanting (dye-assisting) process which markedly improves the natural flame resistant quality of wool. It is known as Zirpro. Their output of treated wool textiles, carpets, aircraft furnishings, curtain fabrics, railway upholstery and blankets now exceeds more than 70 million lb (35 million kg).

10.3.2.3 Zirpro flame retardant treatments

Zirpro flame retardant treatments are based on the exhaustion of negatively charged complexes of titanium or zirconium with fluorides, citrates or other carboxylic or hydroxyl-carboxylic acids on the positively charged wool fibres in acid conditions (pH below 3) at a certain temperature (CSIRO). The complexing agent has to be present not only to avoid the precipitation of the extremely hydrolysis-prone titanium and zirconium compounds but also to ensure the negative charge of the metal complex by excess of the complexing agent. The advantages of zirpro treatments are listed below:

- They cost as little as one-tenth of other available durable treatments. They are the only known flame resist techniques which can be applied by the low-cost exhaustion process during the dyeing operation.
- Low add-on of chemicals keeps the cost down and ensures no increase in the weight of the treated material.
- The effective chemicals are exhausted into the fibre; as a result the handle and the natural soil resistance of wool fibres are in no way impaired.
- Treated wool is not only fire resistant but also heat resistant.
- The physical properties of wool are not adversely affected.
- In all its applications, the treatment is simple; in the commonest method, the processor simply mixes chemicals together and adds them to the dye-bath.
- Treatment can often be carried out concurrently with any one of the number of routine process applied to wool.
- Flexibility: various application methods have been devised to cover all possible requirements and products.
- The treatment has been successfully tested against 50 washings at 40°C, and against dry-cleaning.
- Colour fastness of treated wool to water and perspiration is not affected.

- Use of organic FRs commonly increases smoke emission, but wool treated with the new mordanting process does not show a significant increase.
- The new treatments are compatible with easy-care treatments for wool including machine washability.

10.3.2.4 Fibre blends with wool

Bourbigot et al. (2007) shows that high performance fibres such as aramides (known as heat and flame resistant) – unfortunately with poor handle – can be blended with wool to achieve better handle and higher synergistic flame retardancy effects.

Blends of wool with high performance fibres were investigated. Kevlar (PPTA or poly-p-phenylenediamine-terephthalamide) was chosen because it can lead to a synergistic effect (in terms of HRR) in association with the wool and because it has an acceptable cost (Bourbigot et al., 2005). Kevlar/wool blends were studied in different structures (blends yarn by yarn and fibre by fibre, double woven rib structure and double faced structure).

Horrocks and Kandola (1997) expect one promising approach to the manufacture of hybrid core yarn Kevlar/wool blends, because they exhibit natural yarn aspect. A good handle and good dyeability can be expected from this method, along with the preservation of high performance in terms of flammability and mechanical properties.

10.3.3 Leather

Leather is an excellent natural product that is widely used not only in the shoe industry, but especially in high-end upholstery products and the luxury car industry. For both these applications its behaviour in fire conditions is very important. Leather is both safer and healthier than man-made products and textiles used in the automobile sector and for home furnishings. Leather is not dripping.

10.3.3.1 Flammability of leather

Tanned leather is resistant to short-term exposure to temperatures of up to 200°C (higher temperatures result in pyrolysis). Exposure to temperatures in the range of 130–170°C for half an hour or so causes no structural changes in leather. Resistance to higher temperatures requires appropriate finishing.

In order to determine the flammability of natural and artificial leather, measurements were carried out (Kozłowski et al., 2006) using ISO 3795:1989(E) and EN ISO 6940:2004 methods. The results of these measurements are presented in Tables 10.6 and 10.7.

The results obtained using the ISO 3795:1989(E) method allow the leather investigated to be classified as a non-ignitable material (combustion time: 0 mm/min). On the other hand, artificial polyurethane (PU) leather does ignite, and flame spreads at the rate of 66 mm/min.

The length of time for which the sample is not ignited and does not glow during the exposure of the surface and edge to flame was determined by the EN ISO 6940:2004

Table 10.6 Leather flammability in compliance with ISO 3795:1989(E) (Kozłowski et al., 2006).

Result	Natural leather (for furniture applications)	Artificial PU leather
Length of sample burnt (mm)	0	254
Combustion time (s)	0	230
Flammability degree (mm/min)	0	66
Other observations	Ignition, glowing, flame going out before the first point of the measurement	Glowing: 1850 s causing a slow ashing of the sample

Table 10.7 Leather flammability in compliance with EN ISO 6940:2004 (Kozłowski et al., 2006).

Material	Place of contact with flame	Time of contact with flame (s)	Time of sample combustion (s)	Observations	
				Time of glowing (s)	Length of sample burnt (mm)
Natural leather	Surface (grain)	18	0	0	Local
		19	0	593	28
	Edge	5	98	Over 600	200 (whole)
Artificial PU leather	Surface	4	0	0	Local
		4	135	403	Ashing
	Edge	3	0	0	10
		1	71	313	Ashing

method. In the case of natural leather, the time of surface exposure to flame is 18 s, whereas for artificial leather it is 4 s (Table 10.7). When the edge of the fabric is exposed to flame, natural leather ignites after 5 s, smoulders slowly, glows for a long time and then shrinks. Artificial leather, on the other hand, ignites immediately on contact with flame, burns slowly and then glows until the sample undergoes total ashing.

The results of flammability measurements performed on a cone calorimeter are given in Table 10.8.

The HRR for natural leather is 190 kW/m² (on average), which is clearly lower than that observed for artificial leather (Table 10.8). The time to sustained ignition (TI) in the case of natural leather is 2.1 times longer than that of artificial leather and the MLR

Table 10.8 Leather flammability determined using a cone calorimeter in compliance with ISO 5660 – 1:2002 (E) (Kozłowski et al., 2006).

Measurement parameters (heat flux of 35 kW/m ²)	Dimensional unit	Natural leather	Artificial PU leather
Peak HRR	kW/m ²	190.60	278.82
Time to sustained ignition (TI)	s	40.11	19.28
Total heat released (THR)	MJ/m ²	14.95	10.09
Average heat of combustion (HOC _{av})	MJ/kg	19.87	16.72
Average MLR (MLR _{av})	g/s m ²	2.09	4.44
Average SEA (SEA _{av})	m ² /kg	137.66	238.32
Average CO emission (CO _{av})	kg/kg	0.028	0.043
Average CO ₂ emission (CO _{2,av})	kg/kg	2.110	2.059

is 2.1 times lower for natural leather, which indicates a slow burning of the material. Smoke emission, expressed by specific extinction area (SEA), in natural leather is almost twice as low as that for artificial leather. Natural leather is also safer because the level of carbon monoxide emitted is one and a half times lower.

Studies on the flammability of natural and artificial leather have shown that natural leather is safer in case of fire due to its longer ignition time (as evaluated by applying three different tests) and lower emission of carbon monoxide compared to artificial leather.

One drawback of natural leather, however, is its tendency to glow, which can cause long-lasting smouldering (up to several hours) of upholstery. It is therefore necessary to apply FRs or flame-retarding barriers to leather used for upholstery applications (Kozłowski et al., 2016).

No revolutionary FR system has been developed in the last decade, particularly in the area of environmentally friendly durable finishes for all types of fibres and fabrics. Progress has responded to legislative pressures, specific test methods, cost and environmental influences.

M. Levin (Lewin, 2005), very famous person in flame retardancy science, concluded that:

... notwithstanding the considerable effort spent in the fifties, sixties, and seventies of the 20th century on the flame retarding of cotton, no successful treatment has evolved. There is still no treatment which would render FR cotton fabrics durable to multiple hot alkaline soft and hard water launderings, without changing markedly the mechanical, physical and aesthetic properties with materials containing environmentally friendly FRs, at a reasonable cost. Whereas for cotton fabrics, partial solutions exist, there are virtually no solutions for blends of cotton/polyesters, in spite of the enormous economic importance for such products. Similarly, no durable FR treatment which would preserve the mechanical and physical properties was developed for textiles. Existing treatments are non-durable to atmospheric conditions and suffer sizable losses in the mechanical properties.

Developing new FR systems for the automotive and aircraft industries is another important challenge. Two basic challenges for the future can be discerned: one challenge is the development of several new kinds of catalysts for FR systems, based on organometallics and macromolecular metal complexes on one hand and catalytic particles or catalysts precipitated on nanoparticles on the other hand. Another challenge is the application of nanocomposites.

10.3.4 *The range of application of FR fabrics*

- Apparel and garments — sleepwear, nightwear, children's wear, kitchen wear, etc.
- Uniforms for fire-fighting personnel, armed forces, police, etc.
- Protective clothing for workers in many industries such as petrochemicals, oils, paints and solvents, electricity generation and distribution, metalworking, welding, gas storage and distribution, etc.
- Home furnishing and decorations — curtains, drapes, upholstery, bedding, mattresses, wall coverings, carpets and rugs, etc.
- Industrial fabrics — brattice cloth for coal mines, carpet backing fabrics, barrier fabrics as overlay on foam and rubber cushions, underlay in motor vehicles and aircraft industry, etc.
- Hotels, restaurants, clubs, dormitories, auditoriums, theatres, cinemas, halls, religious centres, marriage venues, hospitals, schools, colleges, etc. (Kozłowski et al., 2005b)

Lists of non-durable and durable flame retardants are presented in [Tables 10.9 and 10.10](#). Flammability of some fabrics treated by different FRs is presented in [Table 10.11](#). [Table 10.12](#) presents a risk analysis of selected FRs according to the US Consumer Product Safety Council (CPSC).

The recent report from the Sub-committee on Flame Retardant Chemicals (part of the CPSC) is the most authoritative toxicological risk assessment of any FR chemicals to date and used scenarios for dermal and oral exposure and inhalation.

10.4 **Methods of improving flame retardancy in natural fibres**

Many studies have been carried out with the aim of gaining a greater understanding of the behaviour of fire retardants on textiles. Non-durable chemical compounds such as soluble phosphates, borates and halides, as well as more durable treatments, were considered. Among the latter group of compounds were urea–phosphate and other nitrogen–phosphorous combinations.

The other type of bond is the most durable of the chemical bonds between cellulose and the modifying compound (Kozłowski and Helwig, 1998a).

From durable FR treatment two phosphoro-organic systems should be mentioned:

- dialkylphosphonocarboxylic acid amide — PPA — Pyrovatex P, Ciba
- tetrakis(hydroxymethyl) phosphonium — urea — THPC — Proban CC, Albright and Wilson

More recently back coatings consisting of a resin-bonded antimony–bromine system have also been used, as flexible intumescent coatings.

Table 10.9 Review of fire retardants (non-durable) for fabric protection (Kozłowski et al., 2005b).

No.	Producer	Name
1.	American Cyanamid Co.	Aerotex NDC, NDS; Pyroset BC
2.	Thor Chemicals Ltd.	Aflaman LS, GK; Aflaman PS; Flammentin AS, CN
3.	BASF	Akaustan
4.	Albright	Amgard TR
5.	Lutex Chemical	Banfire
6.	Apex Chemical Co.	Celluset 3, 7, 40; Flameproof 2084; Flameproof 311, 4227; Flameproof 260
7.	Consos Inc.	Consos Flame Retarder 270
8.	White Chemical Corp.	F/R P-26 solution
9.	Polymer Research	Fire Guard No 60
10.	Arkansas Chemical Co.	Fi-Retard 5M
11.	Dr Th Bohme	Firex 4100; Firex 4160
12.	Schill & Seilacher	Flacavon F 71, R, RL, PS
13.	DuPont Industrial Chem Dep.	Flame Retardant 12, CM
14.	Zachimer und Schwarz	Flammex CE
15.	Chemische Fabrik Pfersee	Flovan AS; Flovan BU; Flovan FD
16.	Ciba	Flovan CG
17.	Huntsman's Textile Effects	Flovan CWF
18.	Innovative Company DELTA	Fobos M-2T
19.	Crown-Metro Inc.	Fyran B; Fyran JB; Fyran P
20.	Chemical Co.	Fyrol 99; Fyrol HNP
21.	Mudrin	Myflam
22.	Protex	Protenyl NE
23.	Zachimer und Schwarz	Pyrex AM
24.	Laurel Products Co.	Pyrosan LP
25.	Rudolf Chemische Fabrik	Rucon Flammfest
26.	Sun Chemical	Warconyl 175, 712

Table 10.10 Review of fire retardants for durable (wet cleaning) fabric protection (Kozłowski et al., 2005b).

No.	Producer	Name
1.	Thor Chemicals Ltd.	Aflamman IST, PCS; Aflammit KWB; Aflamman Al
2.	BASF	Akaustan Pc
3.	Albright and Wilson	Antiblaza NW; Proban 210, 420 A, NX, CI; Retardal AC, S
4.	Yohimura	Apiros 307
5.	White Chemical	Caliban F/R P-26; Caliban F/R P 53
6.	Ugine Kuhlmann	Carbinul PA
7.	Schill und Seilacher	Flacavon AR
8.	Arkansas Chemical Co.	Flame Snub WND, WD + WDC
9.	Dainippon Ink and Chemicals Inc.	Flameguard 5518, 5518conc, 5527; Flameguard 6288NS, 8115S
10.	Stauffer Chem	Fyrol 76
11.	Akzo Chemicals	Fyrol CEF
12.		Permaproof
13.		Preslom AP
14.	Dai-Ichi Kogyo Seiyaku Co. Ltd.	Pyroguard F-120
15.	American Cyanamide Co.	Pyroset TKO, TKP, CP
16.	Ciba	Pyrowatex CP
17.		Roxel
18.	Rudolf Chemische Fabrik	Rucon FlameproofS
19.	Daikyo Chem Co. Ltd.	Supervigol DS

Table 10.11 Flammability of some fabrics treated by different flame retardants (according to ISO 4589-2:1996) (Kozłowski et al., 2005b).

Fabrics	Treatment by different fire retardants	LOI
Wool	ZIRPRO finishing	35
Cotton	PYROVATEX CP finishing	34
	PROBAN finishing	28–32
	FOBOS M2T finishing	36
Linen	PYROVATEX CP finishing	28
	FOBOS M2T finishing	27
Linen/polyester	PYROVATEX CP finishing	25
	FOBOS M2T finishing	26

Table 10.12 Risk analysis of 26 selected flame retardants (Lewin, 2005).

Acceptance	Chemical	Use in furnishings	
Acceptable	Hexabromocyclododecane	+	
	Decabromodiphenyl oxide	+	
	Alumina trihydrate	+	
	Magnesium hydroxide	+	
	Zinc borate	-	
	Ammonium polyphosphates	+	
	Phosphonamide ('Pyrovatex' type)	+	
	Tetrakis(hydroxymethyl) phosphonium derivatives ('Proban' type)	+	
	Exposure studies needed	Antimony trioxide	+
		Antimony pentoxide and antimonates	+
Calcium and zinc molybdates		-	
Organic phosphonates		+	
Tris (1,3-dichloropropyl 1-2) phosphates		-	
Tris (monochloropropyl) phosphates		-	
Aromatic phosphate plasticizers		-	
Chlorinated paraffins		-	

+, passes the test; -, fails the test.

The first of the two principal systems mentioned above is reactive, and is bonded to cellulose fibre during curing in a formaldehyde cross-linking reaction. The durability of the second FR is not a result of a chemical reaction between cellulose and the phosphorous derivative, but of the ammonia curing process used. Both systems result in fibres with decreased mechanical strength and lead to higher levels of CO emission during combustion.

FRs are used in different quantities depending on their efficiency in reducing flammability and their effect on other textile properties. These data are presented in Table 10.13. The data show compounds that give results at lower percentage add-on levels (19-25); stannic oxide is the best choice, as it is white in colour and non-toxic.

One of the most efficient ways of making combustible materials fire retardant is the application of intumescent coatings. There is a growing interest in intumescent systems for textiles, which, when used with natural textile (mainly lignocellulosic) materials, should be flexible and resistant to more physical and mechanical parameters. This type of fire retardant has a promising future in many different industries (aircraft, upholstered furniture, carpets and rugs, railway carriages, etc.) (Stevens and Mann, 1999).

Table 10.13 The amount of finishing add-on necessary for cotton to acquire flame retardancy (Lewin, 2005).

Fire retardant	Add-on requirement (minimum) % on fabric weight
Ferric oxide	19
Stannic oxide	20
Lead monoxide	21
Manganese dioxide	22
Ferric chromate	24
Antimony (III) hydroxide	30
Antimony oxychloride	30
Lead chromate	37
Tin (IV) oxide, hydrous	40
Titanium (IV) hydroxide	40
Bismuth trioxide, hydrous	40
Zinc stannate	47
Aluminium stannate	54
Aluminium borate	59
Aluminium hydroxide	70
Antimonous oxide	79
Chromium (III) hydroxide	91
Silica, hydrous	100
Aluminium silicate	100
Magnesium ammonium phosphate	125

Intumescent FRs can be incorporated into textile fabrics using two different methods: micro-encapsulation and incorporation into protective coating. Micro-encapsulation is a technology that employs an outer skin, typically a thin polymer shell, to encapsulate active ingredients and release them when the shell is disrupted by external forces/energy (Réti et al., 2008).

Intumescent FRs can also be incorporated into traditional textile coatings, such as butyl rubber, by blending them with the coating prior to its application to the fabric. These coatings are typically used to provide water repellence and/or protection against chemical or biological agents.

Intumescent coatings are able to wholly isolate the covered material from excessive temperature increase and oxygen penetration (Wladyka-Przybylak and Kozłowski, 1999; Kozłowski et al., 2007). They can thus protect flammable materials from thermal decomposition and in consequence against loss of mechanical properties.

The performance of the coating is achieved by the correct selection of the following:

- carbonizing agents,
- foam-forming agents,
- dehydrating agents,
- modifiers, including very effective high dispersion components in nano scale.

The proper selection of components in an intumescent system has a fundamental effect on:

- the velocity of carbon layer formation,
- the structure or resistance of carbon layer to thermal factors,
- durability of the system during storage,
- the quality of the coating during its application,
- durability of the coating over time.

Modifiers in nano-particle form improve the fire retardancy and thermal insulation effectiveness of the system. The time needed for the formation of a carbonized layer is reduced. The structure of the carbon skeleton is improved, becoming a small-cell structure. In consequence, this allows a reduction in the amount of product used and in protection costs.

10.4.1 Flame retardant textile back-coatings

The advantages of FR textile back coatings are listed below:

- one of the most versatile and cost-effective FRs,
- is applied to the back surface of the fabric,
- does not penetrate the entire fabric,
- has no undesirable chemical interactions with the fibre,
- usually has minimal effect on aesthetic properties of the fabric.

A back-coating formulation normally consists of the following major components:

- polymeric resin binder,
- FR additives,
- fillers,
- application ancillaries.

FR additives commonly incorporated in back-coating formulations are unfortunately compounds containing halogens and antimony, but research has shown that the replacement of antimony–bromine species with phosphorus-containing compounds is possible (Wang et al., 2000).

Rochery et al. (2005) report on the optimization of the structure of a polyurethane/clay nanocomposite used as an FR coating. One of the latest reports deals with an FR coating developed by using a layer by layer assembly technique with branched polyethyleneimine and sodium montmorillonite clay applied to cotton fabrics. According to the authors this is a relatively simple means of obtaining flame resistant clothing and other textiles (Anon).

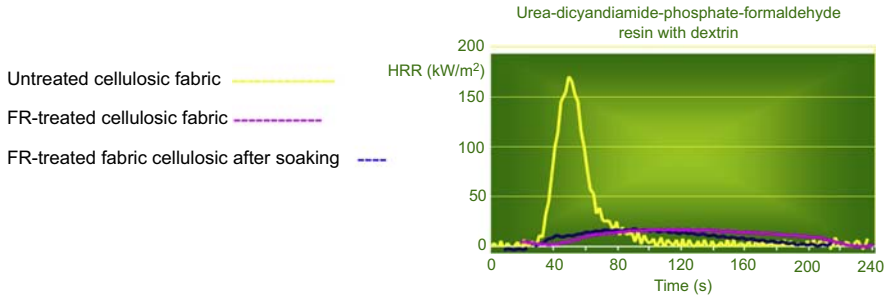

Figure 10.7 Intumescent back coating based on urea–dicyandiamide–phosphate–formaldehyde resin with dextrin. Flammability according to ISO 5660 – cone calorimeter, heat flux, 35 kW/m^2 (Kozłowski et al., 2008). Untreated fabric 1; FR treated fabric after soaking 2; FR treated fabric before soaking 3.

Fig. 10.7 presents the effectiveness of an intumescent back coating based on urea–dicyandiamide–phosphate–formaldehyde resin with dextrin tested by Cone Calorimeter (heat flux 35 kW/m^2) in comparison to untreated cellulosic fabric (Kozłowski et al., 2008). The HRR value dropped from 170 kW/m^2 for untreated cellulosic fabric to 20 kW/m^2 for fabrics covered by this intumescent coating.

This system is not sufficiently durable under hydrophilic atmospheric conditions. New solutions still need to be developed to improve the resistance of the polymer resin components to high humidity.

10.5 Future trends

Recent progress in FRs includes the following principal trends:

- Development of fire retardants with reduced leachability and bioavailability, and lower environmental impact (no toxic properties, higher efficiency).
- Chemical and biochemical modification of natural lignocellulosic and protein polymers including the use of enzymes for flame retardancy.
- Use of more efficient intumescent systems and fire blockers, with better elasticity for fabrics, mostly applied as back coatings.
- Nanostructured FRs offer the opportunity for lowering the consumption of FR additives and upgrading the effectiveness of flame retardancy.
- Functionalization of natural fibres by chemical substitution of reactive groups and plasma, corona, modified with dendrymers and other radiation treatment and micro-encapsulation, which can also improve the effectiveness of flame retardancy.

However, many of the above developments also decrease the mechanical strength of fibres and result in the emission of additional amounts of CO during combustion. This has prompted researchers to investigate safer chemicals that are able to bond with cellulose. These have been shown to include *alkyl borates*.

- Another promising development seems to be the application of genetic engineering to obtain *transgenic lignocellulosic and protein fibres with incorporated fire retardants*, which are partially substituted for functional groups. This application is, however, still at the basic research stage.

- A technology named **superfine melt technology** is a recent technology which involves making the flame retardants to very small size, which increases the surface area making the flame -retardant even better and efficient.
- **Smoke abatement technology** is a new technology in which it suppresses the smoke thereby making it more efficient and effective.
- Other innovative technologies are cross-linkage technology, surface modification technology and macromolecule technology (Niveda and Shanthi, 2018).

A potential alternative to commercially available treatments for cellulose based polymers, G. Rosace in 2017 had found a unique finishing process by grafting a combination of vinylphosphonic acid and methacrylamide on textile samples, in presence of potassium persulfate (KPS) as radical initiator. The obtained coating was able to enhance the thermal stability of cotton giving rise to a new halogen free flame retardant finishing (Rosace et al., 2017).

- **Mineral fillers** are an important class of fire retardant which are very difficult to be added also into a polymer and textiles. Aluminium/magnesium hydroxide and magnesium carbonate are endothermically decomposing and have a great demand as sustainable fire retardants. Added to these, mixed calcium/magnesium carbonate and hydroxides such as mixtures of huntite [$\text{CaMg}_3(\text{CO}_3)_4$] and hydromagnesite which are naturally occurring are also environment friendly (Hull et al., 2011).
- **Nanotechnology** is an emerging technology which is implemented in consumer products because of its functionalities as flame retardance, self-cleaning, antimicrobial property and decreasing the level of use flame retardants, etc... Aluminium oxide (Al_2O_3) and nanoclays such as montmorillonite in the nanomaterials are generally applied in both the fibre stage or in the fabric finishing stage to achieve flame retardancy. Researches on various nanoparticle coatings on synthetic and natural fibres are going on to find the best nano-coating for flame retardancy. (Niveda and Shanthi, 2018).

A team from University of Pennsylvania has developed a sandwich structure similar to that of corrugated cardboard, but in nanoscale. The researchers envision the material, made from an ultrathin aluminium oxide film, being used for a variety of aerospace and microrobotic applications. To make the material, the team started with a silicon template with holes and then coated all its surfaces with aluminium oxide (Jansen, 2018).

Researches on various nanoparticle coatings are going on to the best nano-coating for flame retardancy and for example sodium cloisite is found to be efficient in terms on polyester cotton blends (Alongi and Tata, 2015)

- New technologies for applying flame retardants are emerging which also involves utilization of **microcapsules for finishing**.

Microencapsulation is a promising technique for the finishing of fabrics with flame retardants. Microcapsules with the core as water soluble organophosphorus are promising flame retardants. Water soluble dimethyl methyl phosphonate (DMMP) and the acetal product of polyvinyl alcohol (PVA) and glutaraldehyde (GA) as microcapsules act effective flame retardants for cotton fabrics. Generally phosphates water soluble but microcapsules Di-ammonium hydrogen phosphate (DAHP) as core and polyurethane (PU) shell has a significant FR effect on cotton fabrics.

The most widely used flame retardant is Alumina Trihydrate (ATH). ATH works at approximately 220°C. The three water molecules in ATH are released in an endothermic reaction which quenches the surface of the surrounding materials. Thus the smoke is suppressed and flame retardants effect are obtain (Niveda and Shanthi, 2018)

- More recent work carried out by Richard Horrocks from University of Bolton has led to a patented process (Horrocks et al., 2009, 2011) in which using **atmospheric plasma** have demonstrated that the flash fire resistance of a both pure cotton, flame retarded cotton and poly(meta-aramid) fabrics may be improved by surface treatment in the presence of a clay and a silicon-containing monomer such as hexamethylene disiloxane (HMDSO).

The adoption of plasma technological modification by the textile industry has been slow (Richard Horrocks and Liu, 2015). One of the main reasons for this is that the majority of successful plasma applications occurred using low pressure plasma and it is only recently that atmospheric pressure plasma technologies have been developed which are considered to be more appropriate to continuous processing of textile fabrics. Thus future research efforts should be cognizant of this requirement, especially given that the established non-thermal plasma processes previously feasible at low pressures have been successfully transferred to atmospheric pressure conditions as evidenced by the current (2010) range of Dielectric Barrier Discharge, arc-jet, microwave and hybrid sources available (Richard Horrocks and Liu, 2015).

- **The layer-by-layer method** when combined with other technologies has also been used to improve the flame retardance of cotton fabrics. Wang et al. (2015) have applied an intumescent coating composed of a nitrogen-modified silane hybrid and phytic acid deposited on to cotton fabric through the combination of sol-gel process and layer-by-layer techniques in order to reduce flammability of the fabric. The cationic solution for the cotton fabric impregnation was synthesized by the **sol-gel technique**.
- Hybrid phosphorus-doped silica films have been prepared through **sol-gel processes** to enhance the thermal and fire stability of cotton. FT-IR spectroscopy was exploited for assessing the formation of the silica skeleton on the cotton surface and for evaluating the interactions between the cellulosic fibres and the doped film. The sol-gel treatments in the presence of phosphorus and nitrogen turned out to play a protective role on the degradation of the cotton fibres (Alongi et al., 2012).
- Recent interest has also been shown in the potential use of **gamma radiation** to induce polymerization and grafting of a novel phosphorus-, nitrogen-, and sulphur-containing monomer, diethyl (acryloyloxy) ethylthiophosphoramidate (DEAETPN) on to cotton fabric to obtain levels of flame retardancy (Verma and Kaur, 2012).

10.6 Sources of further information and advice

For more regulatory information on FRs see the following resources:

- www.albemarle.com – information on Albemarle Corporation and its products
- www.firesafety.org – role of flame retardants in fire prevention
- www.bsef.com – Bromine Science & Environmental Forum
- www.firemarshals.org – National Association of State Fire Marshals
- www.acfse.org – European fire safety coalition

- www.ebfrip.org – European brominated flame retardant industry
- www.cefic-efra.com – EFRA European Flame Retardant Association

Web addresses of agencies and organizations related to the textile flammability standards: www.cpsc.gov (US Consumer Product Safety Commission); www.bearhfti.ca.gov/(California Bureau of Electronic and Appliance Repair, Home Furnishings and Thermal Insulation (BEARHFTI)); www.astm.org (ASTM International); www.gpoaccess.gov/fr/ Federal Register; www.nfpa.org (NFPA - National Fire Protection Association); www.nist.gov (NIST - National Institute of Standards and Technology, US); www.europeanfiresafetyalliance.org (EFSA - European Fire Safety Alliance); www.old.ctif.org (CTIF - Comité Technique International de Prévention du Feu); www.ctif.org/world-fire-statistics (WFS-World Fire Statistics).

- Fink, U., Hajduk, F. and Ishikawa, Y., 'Flame retardants': <http://www.sriconsulting.com/SCUP/Public/Reports/FLAME000>
- 'US demands for flame retardants to grow' (October 2007): http://www.pcimag.com/copyright/BNP_GUID_9-5-2006_A_1000000
- Recent Advances in Flame Retardancy of Polymeric Materials, ed. by Menahem Levin, Proceedings of the 1999 Conference, Business Communication Com. Inc., vol. X
- Kozłowski R, Muzyczek M., Kicińska A.: '*Natural fibres for interior textiles*', in book INTERIOR TEXTILES: DESIGN AND DEVELOPMENTS by Trevor Rowe, Woodhead Publishing Ltd. Cambridge (UK) 2009.
- Kozłowski R., Muzyczek M., Walentowska J.: '*Flame Retardancy and Protection Against Bio-Deterioration of Natural Fibres. State-of-Art and Future Prospects*' in book 'Polymer Green Flame Retardants: A Comprehensive Guide to Additives and their Applications,' by: Constantine D. Paspaspyrides, Pantelis Kiliaris, Elsevier Ltd., 2014.
- Kozłowski R., Muzyczek M.: '*New smart environmentally - friendly composite coatings for wood protection*', in book Smart Composite Coatings and Membranes: Transport, Structural, Environmental and Energy Applications by M.F. Montemor, Woodhead Publishing, 2016.
- Handbook of fire resistant textiles, ed. by F.S. Kilinc, Woodhead Publishing Series in Textiles No. 140
- Fire and Fire Safety in 2014, Statistics Journal, Statistics of Fires and their analysis – Moscow, Russia, VNIPO, 2015.
- Les Statistiques des Services d'Incendie et de Secours (Statistics of fire service calls in France) – Edition 2015.
- The Singapore Civil Defence Force. Annual report 2015.
- Annuario statistico del corpo nazionale dei vigili del fuoco (Annually statistics of fire service in Italy) 2015.
- Fire and rescue statistical release. Great Britain. Department for Communities and Local Government 2015.
- Annual report. New Zealand Fire service commission 2015.

10.7 Conclusions

1. In light of the data on casualties caused by fire, the protection of natural lignocellulosic and protein fibres against fire is of ever increasing importance. Significant progress has been made in this regard in the last 4 decades, both in terms of providing an explanation for all the phenomena that occur during the combustion of different materials, including natural fibres, and in the synthesis of new flame retardants. This progress has been accompanied by a

focus on the use of fire proofing compounds which are both safer for people and environmentally friendly.

2. The importance of these requirements is on the increase, and fire retardants that cause only a slight increase in the emission of the toxic gaseous products of combustion are frequently preferred, even if they are less efficient at reducing such parameters as ignition, HRR and surface spread flame.

Fortunately, the combustion mechanism of natural fibres is considerably different from that of man-made fibres; dripping is also a problem in the latter under fire conditions. This is the reason behind the revival of the production and application of fire retardants based on simple chemical compounds such as boric acid and its derivatives, ammonium phosphates, silicates, aluminium and magnesium hydroxides, etc.

3. New developments in fireproof materials have been achieved, such as fire blockers and fire barriers, which combine several fire retardant mechanisms. Modern solutions to the problem will also come from biotechnology, in the form of biochemical modification of lignocelluloses for different applications, by functionalization of reactive groups of natural fibres.

References

- Addit. Polym. 2017 (1), January 2017, 10–11. Published by Elsevier Ltd. [https://doi.org/10.1016/S0306-3747\(17\)30014-3](https://doi.org/10.1016/S0306-3747(17)30014-3).
- Ahmed el Shafei, 2018. Sustainable dyeing and finishing: ultra-deep black dyeing of cotton and structure-property relationship of halogen-free flame retardants. In: 7th International Technical Textiles Congress, 10-12 October 2018, Izmir, Turkey.
- Alongi, J., Tata, J., 2015. A comparative analysis of nanoparticle adsorption as fire-protection approach for fabrics. *Polymers* 7, 47–68.
- Alongi, J., Colleoni, C., Rosace, G., Malucelli, G., 2012. Thermal and fire stability of cotton fabrics coated with hybrid phosphorus-doped silica films. *J. Therm. Anal. Calorim.* 110 (3), 1207–1216.
- Anon. Chem. Eng. News, Clay layers help fabrics fight flames 88 (23), 37.
- Arens, M., 2004. US fire statistics for 2003. In: American fire safety Council, Annual International Fire Safety Conference, Las Vegas, 27–29 September 2004.
- Baitinger, W.F., 2002. Enhanced thermal protective characteristics from flame resistant cotton/nylon blends. In: BCC Conference on Flame Retardancy, Stamford, CT, 3–5 June 2002.
- Bolens, C., et al., 1999. Melamine based flame retardants – A promising future. In: DSM Melapure, 10th Annual BCC (Business Communication Corporation) Conference on Flame Retardancy of Polymeric Materials, Stamford, CT, 24–26 May 1999.
- Bourbigot, S., Duquesne, S., Flambard, X., Bellayer, S., Rochery, M., Giraud, S., Vroman, I., 2005. Flame retardancy of textiles: recent advances. In: FRPM'05, Berlin, Germany, 7–9 September 2005.
- Bourbigot, S., Duquesne, S., Bellayer, S., Flambard, X., Rochery, M., Devaux, E., 2007. Advances in the flame retardancy of the polymeric materials: current perspectives. In: Schartel, B. (Ed.), Presented at FRPM' 05. Novel Developments in Flame Retardancy of Textiles, Books on Demand GmbH, Norderstedt, pp. 159–180.
- CTIF, 2006. World Fire Statistics, Report No. 10, Centre of Fire Statistics of CTIF, Belgium (CTIF - Comité Technique International de prevention et d'extinction de Feu).

- Dawson, R.B., Landry, S.D., Steukers, V., 2004. The current regulatory status for flame retardants. In: Annual BCC Conference on Flame Retardancy, Stamford.
- Dingemans, M.M.L., J Ramakers, G.M., Gardoni, F., et al., June 2007. Neonatal exposure to brominated flame retardant BDE-47 reduces long-term potentiation and postsynaptic protein levels in mouse hippocampus. *Environ. Health Perspect.* 115 (6), 865–869.
- Evarts, B., September 2018. Fire Loss in the United States During 2017. Report: NFPA's. <https://www.nfpa.org/News-and-Research/Data-research-and-tools/US-Fire-Problem/Fire-loss-in-the-United-States>.
- <https://www.flameretardants-online.com/flame-retardants/market>.
- Guan, J.P., Chen, G.Q., 2006. Flame retardancy finish with an organophosphorus retardant on silk fabrics. *Fire Mater.* 30 (6), 415–424.
- Hogue, C., 2010. Blueprints for chemical control. *Chem. Eng. News* 30–31, 4.
- Hogue, C., June 4, 2018. Bill targets firefighting fluorochemicals at US airports. *Chem. Eng. News* 96 (23), 15–15.
- Holme, I., 1993. New developments in the chemical finishing of textiles. *J. Text. Inst.* 84 (4), 520–533.
- Horrocks, A.R., Kandola, B.K., 1997. Flame retardant cellulose textiles. In: 6th European Meeting on Fire Retardancy of Polymeric Materials, Lille, France, 24–26 September 1997.
- Horrocks, A.R., Kandola, B.K., Nazaré, S., et al., 2009. Flash Fire Resistant Fabric. UK Patent Application 0900069.6, pp. 1–5.
- Horrocks, A.R., Nazaré, S., Masood, R., et al., 2011. Surface modification of fabrics for improved flash-fire resistance using atmospheric pressure plasma in the presence of a functionalised clay and polysiloxane. *Polym. Adv. Technol.* 22 (1), 22–29.
- Hull, T.R., Witkowski, A., Hollingbery, L., 2011. Fire retardant action of mineral fillers. *Polym. Degrad. Stab.* 96 (8), 1462–1469.
- Innes, J.D., 1996. Flame retardants and their market applications. Fire Retardant Chemicals Association. In: Flame Retardants – 101: Basic Dynamics; Past Efforts Create Future Opportunities, Baltimore, Maryland, 24–27 March 1996.
- Jansen, K., November 26, 2018. Aluminum oxide nanocardboard is strong yet bendable. *Chem. Eng. News* 96 (47), 7.
- Kandola, B.K., 1996. Flame-retardant treatments of cellulose and their influence on the mechanism of cellulose pyrolysis. *J. Macromol. Sci. C Polym. Rev.* 36 (4), 721–794.
- Kobes, K., Groenewegen, Ter Morsche, January 2009. Consumer Fire Safety: European Statistics and Potential Fire Safety Measures. Final report Version: 3.0 Project number: 431N8032 M. Netherlands Institute for Safety NIBRA. www.ifv.nl/kennisplein/Documents/09-06-24_rapport_consumer_fire_safety_pdf1.pdf.
- Kovar, R.F., Farrell, B., Tiano, T., Levy, R., Rubin, L., 1994. Microencapsulated fire retardants for flame resistant tentage textiles. In: BCC Conference on Flame Retardancy, Stamford, CT, 24–26 May 1994.
- Kozłowski, R., Helwig, M., 1998a. Progress in fire retardants for lignocellulosic materials. In: 5th Arab International Conference on Materials Science, Alexandria, Egypt, March 22–25, 1998.
- Kozłowski, R., Helwig, M., 1998b. Fire retardancy of lignocellulosic composites. In: Proceedings of 9th Annual BCC (Business Communication Corporation) Conference on Flame Retardancy of Polymeric Materials, Stamford, 1998.
- Kozłowski, R., Muzyczek, M., 1986. Flammability of wool and its fireproofing problems. In: Fourth International Wool Conference, Gdynia Wool Federation, Sliven, Bulgaria, 10–11 June 1986.

- Kozłowski, R., Władyska-Przybylak, M., 2001. Natural polymers, wood and lignocellulosic materials. In: Horrocks, A.R., Price, D. (Eds.), *Fire Retardant Materials*, pp. 293–317. Cambridge: UK.
- Kozłowski, R., Mieleniak, B., Muzyczek, M., Kubacki, A., 2002. Flexible fire barriers based on natural nonwoven textiles. *Fire Mater.* 26, 243–246.
- Kozłowski, R., Muzyczek, M., Mieleniak, B., 2005. Upholstery fire barriers based on natural fibres. In: Goloshchapov, A.N., Zaikov, G.E., Ivanov, V.V. (Eds.), *Essential Results in Chemical Physics and Physical Chemistry*. Nova Science Publishing, New York, pp. 87–97.
- R. Kozłowski, M. Muzyczek, B. Mieleniak, D. Wesolek and M. Przybylak: ‘Available flame retardant treatment for natural fibres’, General Assembly of Flexifunbar Project, Poznan, 10–11 March 2005.
- Kozłowski, R., Mieleniak, B., Muzyczek, M., Fiedorow, R., November 2006. Flammability and flame retardancy of leather. *Leather Int.* 24–26.
- Kozłowski, R., Wesolek, D., Władyska-Przybylak, M., Duquesne, S., Vannier, A., Bourbigot, S., Delobel, R., 2007. Intumescent flame-retardant treatments for flexible barriers. In: Duquesne, S., Magniez, C., Camino, G. (Eds.), *Multifunctional Barriers for Flexible Structure: Textile, Leather and Paper*. Springer, Berlin, pp. 39–59.
- Kozłowski, R., Muzyczek, M., Mieleniak, B., 2016. Flammability and flame retardancy of leather. In: 2nd International Conference – Science for Business: Innovations for Textiles, Polymers and Leather, ŁÓDŹ, 21.10. 2016.
- Kozłowski, R., et al., 2008. Flexifunbar EU Frame Project: Multifunctional Barrier for Flexible Structure (Textile, Leather and Paper). Final Activities Report, Lille.
- Lewin, M., 2005. Fire retardancy: challenges of the past, present and future. In: FRPM’05, Berlin, Germany, 7–9 September 2005.
- Merritt, M.J., 1954. *Textile Fibres, Their Physical, Microscopic, and Chemical Properties*, sixth ed. John Wiley & Sons, Inc., New York.
- Nazare, S., Kandola, B., Horrocks, A.R., 2002. The determination of heat release parameters from textile fabrics using cone calorimetry as a means of establishing burn hazard. In: Annual BCC Conference on Flame Retardancy, Stamford, CT, 3–5 June 2002.
- News from the World of Technical Textiles, July 2016. Colourage, pp. 74–75.
- Niveda, R., Shanthi, R., December 2018. A review study on the various fibres, finishes and standards for flame proofing of home textiles. *Colourage* 27, 38–40.
- Posner, S., 2009. *Developments in Flame Retardants for Interior Materials and Textiles. Interior Textiles: Design and Developments* by Trevor Rowe. Woodhead Publishing Ltd., Cambridge, UK, pp. 211–257.
- Réti, C., Casetta, M., Duquesne, S., Bourbigot, S., Delobel, R., 2008. Flammability properties of intumescent PLA including starch and lignin. *Polym. Adv. Technol.* 19, 628–635.
- Richard Horrocks, A., Liu, W., September 2015. Recent developments and challenges in flame retardation of textiles and fibres. *Mater. China* 34 (9), 659–674.
- Rochery, M., Taktak, M., Giraud, S., Lewandowski, M., Devaux, E., Bourbigot, S., Alexandre, M., Dubois, P., 2005. Optimisation of the structure of a polyurethane/Clay nanocomposite used as flame-retardant textile coating. In: FRPM’05, Berlin, Germany, 7–9 September 2005.
- Rosace, G., Colleoni, C., et al., 2017. Intumescent flame retardant properties of graft copolymerized vinyl monomers onto cotton fabric. *Mater. Sci. Eng.* 254 (122009).
- Stevens, G., Mann, A., 1999. *Risks and Benefits in the Use of Flame Retardants in Consumer Products. A Report for the Department of Trade and Industry*. University of Surrey, pp. 1–75.

- Report: Non-Halogenated Flame Retardants Market for Polymers – Global Industry Analysis, Size, Share, Growth and Forecast, 2012 – 2018, Transparency Market Research. http://www.transparencymarketresearch.com/sample/sample.php?flag=S&rep_id=1273.
- van Hees, P., Andersson, P., Hjothman, M., Wenne, N., Hassan, M.A., 2010. Use of the Cone Calorimeter and ConeTools software for development of innovative intumescent graphite systems. *Fire Mater.* 34 (7), 367–384.
- Verma, S.K., Kaur, I., 2012. Gamma-induced polymerization and grafting of a novel phosphorous-, nitrogen-, and sulfur-containing monomer on cotton fabric to impart flame retardancy. *J. Appl. Polym. Sci.* 125 (2), 1506–1512.
- Vroman, I., Dumont, V., Giraud, S., Saihi, D., Bourbigot, S., 2005. Nanoencapsulation of ammonium phosphate as fire retardant for textile. In: Conference Proceeding 10th European Meeting on Fire Retardancy and Protection of Materials (FRPM'05), Berlin, Germany, 7–9 September 2005.
- Wakelyn, P.J., Rearick, W., Turner, J., 1998. Cotton and flammability: overview of new developments. *Am. Dyest. Report.* 87 (2), 13–21.
- Wakelyn, P.J., Wolf, S., Oliver, K., 2003. Cotton batting fire blocking barriers for soft furnishings. In: BCC Conference on Flame Retardancy, Stamford, CT, 2–4 June 2003.
- Wang, M.Y., Horrocks, A.R., Horrocks, S., Hall, M.E., Pearson, J.S., Clegg, S., 2000. Flame retardant textile back-coatings. Part 1: antimony-halogen system interactions and the effect of replacement by phosphorus-containing agents. *J. Fire Sci.* 18 (4), 265–294.
- Wang, X., Romero, M.Q., Zhang, X.Q., et al., 2015. Intumescent multilayer hybrid coating for flame retardant cotton fabrics based on layer-by-layer assembly and sol–gel process. *J. RSC Adv.* 5, 10647–10655.
- Weil, E., Yang, C., 2008. Textile flame retardancy – state of art and recent progress. In: Annual BCC Conference on Flame Retardancy, Stamford, CT, 2008.
- Weil, E.D., Patel, N., Chia, H.H., Huang, H., Zhu, W., 1993. A systems approach to flame retardancy and comments on modes of action. In: Proceedings of the 2nd Beijing International Symposium/Exhibition of Flame Retardants, Beijing, China, 11–15 October 1993.
- Wesolek, D., Kozłowski, R., 2002. Toxic gaseous products of thermal decomposition and combustion of natural and synthetic fabrics with and without flame retardant. *Fire Mater.* 26, 215–224.
- Wilkie, C., et al., 2009. In: *Fire Polymers*, ACS Symposium Series, vol. 10013. American Chemical Society, Washington, DC.
- Wladyka-Przybylak, M., Kozłowski, R., 1999. The thermal characteristics of different intumescent coatings. *Fire Mater.* 23, 33–43.
- Wool Blend Mark. Pure New Wool, IWS Flame Resist Treatments. Flame Resistance of Wool. <http://www.csiro.au>.
- Yang, C.Q., Qiu, X., 2006. Flame retardant finishing of cotton fleece fabrics using a reactive organophosphorus oligomer. In: BCC Conference on Flame Retardancy, Stamford, CT, 22–25 May 2006.
- Yang, C.Q., Wu, X., Qiu, X., 2006. Flame retardant finishing of cotton fleece fabrics using phosphorous and nonphosphorous chemicals. In: 16th Annual BCC Conference, Stamford, CT, 21–24 May 2006.
- Yoshioka, T., Hirano, R., Shioya, T., Kako, M., 1990. Encapsulation of mammalian cell with chitosan-CMC capsule. *Biotechnol. Bioeng.* 35, 66–72.
- Zhang, G., Zhang, C., Wang, D., Zhong, L., Zhang, F., August 2018. A novel reactive phosphorous flame retardant for cotton fabrics with durable flame retardancy and high whiteness due to self-buffering. *Cellulose* 25 (10).

This page intentionally left blank

Bast fibres: the role of hemp (*Cannabis sativa* L.) in remediation of degraded lands

11

*Jerzy Mańkowski*¹, *Jacek Kołodziej*², *Krzysztof Pudelko*³, *Ryszard M. Kozłowski*⁴

¹Institute of Natural Fibres and Medicinal Plants (IWNiRZ), Poznań, Poland; ²Institute of Natural Fibres and Medicinal Plants IWNiRZ, Poznań, Poland; ³Poznań University of Life Sciences (UP – Poznań), Department of Biochemistry and Biotechnology, Poznań, Poland; ⁴Journal of Natural Fibers Editor-in-chief, coordinator of FAO/SCORENA European Cooperative Research Network on Flax and other Bast Plants, former director of the Institute of Natural Fibres, Poznan, Poland

11.1 Introduction

The use of lignite as a source of energy is still valid in many countries of the world. This causes a lot of disturbances in the ecology of the natural environment caused by, among others operation of open-cast mines. Open-cast mining works lead to significant geomechanical transformations, to degradation of: the natural structure of the soil profile and the layers of the natural cover of humus. This contributes to the disruption of natural water relations, the quality and quantity of surface waters also change. Water must not interfere with the mining process; therefore, it is necessary to perform drainage of the excavation so as to lower the water level to the pit of the excavation.

Lowering the water level causes drying of watercourses and ponds as well as water falling in lakes and wells. The areas adjacent to the excavation are also subjected to drying. Post-mining lands for long years are excluded from agricultural use. The functioning of the open pit also plays an important role in anthropogenic changes occurring in the soil, causing huge negative transformations in the natural environment. Topsoil (soil cultivation layer) created for thousands of years disappears and the anthropogenic infrastructure is fundamentally changing, many villages and farms disappear and enterprises are shutdown (Mańkowski et al., 2014).

High emission of contamination, mainly due to the developed industrial activity, is characteristic for some areas of Europe. The contamination results from the combustion processes of liquid fuels, coal and gas as well as mechanical, chemical and thermal processing of the obtained mineral raw materials. The pollutants come mainly from emissions of gases and dust to the atmosphere, containing in their composition, among others, carbon monoxide and dioxide, sulphur dioxide, nitrogen oxides, as well as fluorine compounds, sulphides, phenol, aliphatic and aromatic hydrocarbons, etc.

Dust pollutants are mainly: fly ash, dolomite-lime powders, metallurgical dusts with a high content of toxic heavy metals such as: lead, cadmium, zinc, copper, iron,

manganese, nickel, chromium, mercury, etc. Industrial pollution emitted to the surrounding atmosphere, they get into the soil relatively easily, along with atmospheric precipitation and dust fall. In the next stage during vegetation they are taken to plant organisms, where they can become a source of danger for the human body, especially when their level exceeds the acceptable standards (Kozłowski et al., 1991).

Abandoned post-mining areas, without plant cover, excluded from agricultural use, are exposed to wind erosion with all negative effects, including blowing out and blowing mineral material.



Picture 11.1 Backfilling of an open-pit mine.

11.2 Key issues in recultivation of polluted lands

The intense economic development that could be observed from the 19th through the 20th century has left its mark (stigma) on the condition and quality of the natural environment. The development of industry and the exploitation of natural resources have largely contributed to the degradation of the soil environment and its pollution.

Locating industrial centres was dependent on many factors. The most important of them are:

- raw material base and raw material availability (e.g. occurrence of deposits);
- access to water;
- sales markets and employee qualifications;
- technical infrastructure;
- relevant legal regulations.

The development of industry was possible due to the presence of raw materials (e.g. mineral resources, such as: coal, brown coal, ore of: iron, sulphur, zinc, copper, rock salt, potassium salt, crude oil and natural gas), as well as a well-developed hydrographic network. Forming industrial districts have become specialized in the production of specific products. Each industry is characterized by a specific spectrum

of pollution and the level of exposure of natural resources, environmental components to specific anthropogenic threats: physical, biological or chemical.

One of the problems associated with industrialization is the degradation of soils, often used previously in agriculture, caused by the lignite mining industry. Coal is extracted after removing the soil overburden, which is a layer of soil with a thickness of several dozen metres of rock material along with infrastructure, flora and soil. After mining, a lifeless excavation remains, which is constantly filled with material from soil overburden. After levelling the terrain, the layer that was below the surface is located in the arable part. Such top layer is characterized by a trace of humus content and does not have fully developed soil, i.e. a biologically active surface layer.

The problem of developing post-mining areas is a global problem. Lignite is extracted on a large scale in Europe, Australia and the United States (Table 11.1).

In Poland, the area of degraded land currently exceeds 60,000 ha, of which only a small part is recultivated annually. The main direction of remediation is agricultural remediation (Table 11.2).

Phytoremediation is defined as the process of removing or detoxifying pollutants from the environment using so-called higher plants. This technology is based on the ability of certain species and varieties to tolerate high concentrations of toxic compounds, uptake, accumulation and metabolism of these compounds in large quantities in their own organs or to convert them into non-toxic compounds.

Agricultural remediation (remediation) is carried out through cultivation of plants in the polluted areas, which after harvesting are used industrially for energy, food or fodder purposes. These plants are often subject to diseases and pests, which is why they are not a wholesome food for both humans and animals. Plant yields are low, which affects the profitability of the crop. Acquiring low quality crops from degraded areas does not accelerate their remediation.

Table 11.1 The main producers of brown coal in the world (million tonnes).

Country	2012	2013	2014	2015	2016
Germany	185.4	182.7	178.2	178.1	171.5
United States	71.6	70.1	72.1	64.1	66.2
Russian Federation	77.3	73.7	68.9	73.2	73.7
Poland	64.3	65.8	63.9	63.1	60.2
Turkey	68.1	57.5	62.6	50.4	50.4
Australia	71.4	62.3	60.5	65.4	59.7
World total	887.2	834.7	815.7	807.4	783.3

Based on: Prof. dr hab. Eng. Zbigniew Kasztelewicz. Report on the condition of the brown coal industry in Poland and Germany, together with a diagnosis of activities for the development of this sector in the first half of the 21st century.

Table 11.2 Devastated and degraded land requiring remediation and development as well as land reclaimed and developed in Poland in the years 2000–2016.

Specification	2000	2005	2010	2015	2016
	In hectares				
Devastated and degraded lands	71,473	64,978	61,161	63,374	64,651
Land reclaimed during the year	2,235	1,861	1,222	1,807	1,449
Including: For agricultural purposes	456	555	634	1,262	925
Forests	1,345	608	440	282	282
Land developed within a year	1,222	1,132	581	855	587
Including: For agricultural purposes	254	374	299	627	367
Forests	830	266	212	98	137

Based on: Data of the Polish Ministry of Agriculture and Rural Development.



Picture 11.2 Areas before starting the remediation process.



Picture 11.3 Areas before starting the remediation process.

The second important problem is the pollution of post-industrial areas with heavy metals. The content of trace elements in soil can be shaped both by natural and anthropogenic factors. The concentration of heavy metals in soils is conditioned and correlated with many parameters, including with the content of humic compounds, pH, or oxidation-reduction potential.

The first ones include, among others mineralogical composition of the parent rock and the nature and development of soil-forming processes. Depending on the climate, soil properties and geochemical properties of a given element, it undergoes leaching or accumulation processes (Alloway, 1990; Kabata-Pendias and Pendias, 1999). Anthropogenic factors that play the most important role in soil chemistry and their contamination with heavy metals include industrial emissions and improper waste management.

Anthropogenic emission of pollutants in relation to specific compounds is characterized by a certain repeatability resulting from technological progress, widespread use of specific technologies or installations. It is assumed, inter-alia, that the development of certain industries fosters the emission and accumulation of specific types of pollutants and substances that may cause pollution risks, including, among others, heavy metals deposition.

Electroplating, production of dyes, batteries, accumulators, plastics and paints, chemical industry, polymer stabilizers, production of plant protection chemicals, printing, printing and graphic industries — they have an affinity to cadmium emission.

Production of dyes, accumulators, batteries, fertilizers, automotive, energy and electrochemical industry, production of plant protection chemicals — contribute to the emission increase of toxic products, including lead.

Emissions and soil pollution with chromium are accompanied by the functioning of a galvanizing plant, tannery, wood impregnation plant, textile industry, printing and printing companies as well as the production of dyes and plastics.

The metallurgical, dyeing and textile industries, as well as the production of plant protection products and fertilizers, can be associated with increased copper contents in soils.

Usually quicksilver emissions are associated with the production of batteries, phosphoric acid, caustic soda, the operation of pulp and paper mill, production of plant protection products, production of metallic quicksilver, but also with hard coal-fired combustion plants.

The production of fertilizers, paper industry, refineries, steel mills and galvanizing plants can be a source of nickel emission to the ground.

Increased zinc contents in soil and ground are often correlated with the production of batteries and paints, the textile industry, the production of plastics, polymer stabilizers, graphic and printing plants.

Acidification of soils mobilizes and activates most heavy metals in the soil profile, causing the activation of toxic trace elements, their leaching into waters and, as a consequence, disturbance of the balance in the environment in the soil and water environment (Kabata-Pendias and Pendias, 1993; Rosada, 2008). It is estimated that in areas with increased industrial dust emission on average, 70%–90% of the metal content in plants comes from atmosphere (Rosada et al., 1995; Siebielec, 2008).

11.3 Methods of recultivation and remediation of polluted lands

There are three main directions of remediation and development of degraded areas:

- agricultural; creation of arable land, permanent grassland for agricultural purposes, meadows, pastures, orchards, shrub plantations,
- forestry; afforestation of reclaimed areas that have a production or protective function (e.g. soil protection or water protection),
- special; water, recreational, ecological or aesthetic – protective management ([Karczewska, 2008](#)).

At the Institute of Natural Fibers and Medicinal Plants in Poznań, Poland a project related to the agricultural remediation of post-mining sites was implemented: LIFE11 ENV/PL/445, Acronym: EKOHEMPKON, Remediation of degraded land in the region of Lignite Mine Konin by cultivation of industrial hemp (2012–18). Remediation was carried out in the area of 25 ha. Cultivated crops selected in the developed method were fibrous hemp and alfalfa. All organic matter produced fell into the soil by mowing and ploughing. A combination in the crop rotation of hemp; producing a lot of lignocellulosic biomass with the predominant composition of cellulose containing carbon, oxygen and hydrogen with alfalfa growing rich in nitrogen content and leaving organic matter as a green manure, created a specific biological ‘composite’ in the soil that facilitates the relatively rapid formation of humus, increased soil nutrient abundance, improved water and air conditions and created conditions for the multiplication of soil microorganisms beneficial for the fertility of soil.

Hemp is an annual plant, the height of which is up to 3–4 m, yielding a very high yield of dry matter, which in agricultural conditions is about 10 tons/ha. In addition, hemp has a well-developed root system of the pile type with a depth of about 1.0–1.5 m, the root system produces natural, organic channels, drains, allowing access of air and the flow of water and soil gases. Under such conditions, the development of soil microorganisms having basic meaning in the formation of humus occurs. In the remediation implemented, a Polish cultivar of fibrous hemp Białobrzeskie was used. It is a variety bred by the Institute of Natural Fibres ([Mańkowski et al., 2017a,b](#)).



Picture 11.4 Hemp grown in reclaimed areas.

The second one used in the remediation of plants was alfalfa, which unlike hemp is a perennial plant. Alfalfa is also characterized by a large yield of green mass and a deep root system. An important feature of alfalfa as a legume plant is its ability to symbiosis with rhizobia-type rhizobia bacteria with the ability to bind molecular nitrogen. Bound nitrogen serves the plant for the synthesis of proteins. In addition, significant amounts of nitrogen compounds get into the soil and serve as a source of nitrogen for other plants growing simultaneously or afterwards in crop rotation. This is very important in post-mining areas where nitrogen in the soil occurs in trace amounts and is an essential element for the creation of plant proteins and soil microorganisms.



Picture 11.5 Alfalfa grown in reclaimed areas.

Agrotechnical works were carried out in order to prepare areas recultivated for the sowing of selected plants, including hemp *Cannabis sativa* L. sowing and alfalfa. The following works were performed: sowing hemp and alfalfa, care treatments, harvesting and ploughing of biomass obtained.

The main agrotechnical activities included: disking fields, deep ploughing, drying and pre-seeding soil tillage, fertilizing, sowing, mowing, spraying with preparations to accelerate humification and ploughing of biomass. Biomass of hemp and alfalfa, thanks to the fact that it remained in the soil, provided organic matter to accelerate the restoration of the humus layer. Dead parts of plants and microorganisms undergoing humification contributed to the formation of such an important part of the soil as humus.

Remediation was carried out over a 6-year period. The reclaimed area was divided in half for hemp cultivation and alfalfa cultivation. Hemp as an annual plant was sown annually. The sowing of alfalfa due to long-term cultivation was repeated after 3 years. Alfalfa was sown every year only in the places where its cultivation was interrupted. After 3 years, the crop rotation was carried out. In the field after hemp, alfalfa was sown and *Cannabis sativa* L. seeds were sown in the fields after alfalfa cultivation.

Lime fertilization was used only in the first year of remediation. Calcium oxide so-called oxide lime was sown in the amount of 6 tons/ha. Every year in April, fertilizers were sown, in the following doses: nitrogen (N) under hemp in the quantity 150 kg N/ha, while nitrogen fertilization is not used for alfalfa. The cultivation of hemp and alfalfa was fertilized with phosphorus (P_2O_5) in the amount 150 kg/ha, as well as with potassium (K_2O) in the amount 215 kg/ha.

In case of alfalfa, there were mowing operations to limit the growth of weeds, mainly white hepatica (*Chenopodium album* L.). The growing weeds could lead to the suffocation of the sown alfalfa. The problem of the appearance of weeds in hemp was not observed.

Every year in September, treatments related to mowing hemp and alfalfa were carried out. Hemp was mowed using a mower equipped with three cutting bars that cut the stalks in three places. Such cutting facilitated the subsequent ploughing of biomass. After mowing, cut biomass was sprayed with EM (Effective Microorganisms) to accelerate its decomposition and enrich the soil microflora. Immediately after the spraying, stubble disking was performed in order to improve the effectiveness of the microorganisms. The last annual agrotechnical operation performed in November was a deep tillage, to cover the cut biomass (Mańkowski et al., 2017a,b).

The degradation of soils is influenced not only by lignite open-cast mines but also by the presence of heavy metals, mainly from emissions of dust, fumes, as well as from the sewage and industrial waste. Additional contamination of agricultural areas along roads is caused by motorization. It should be emphasized that there is a significant amount (zones around industrial centres, stripes along communication routes), which are not formally excluded from agricultural use, and create a significant threat to human health in the case of cultivation of consumer plants on them.

Methods for the remediation of heavily contaminated soils are based on two main methods. The method of immobilization of metals in soil and the method of extracting metals and removing from soil (Karczewska, 2008) (Table 11.3).

The development of a number of industries related to energy processes, causing emissions into the air, affects the soil environment both directly and indirectly. Presented factors degrading the natural environment occur in varying degrees of severity in each industrialized area.

The most toxic elements are: mercury (quicksilver), cadmium, lead, copper and zinc. Heavy metals that pollute the environment pose a serious toxicological problem, and hazards to human are caused mainly due to the consumption of contaminated food. Cereals, vegetables and fruits are plant products that are a source of human food. For this reason, the presence of heavy metals in them, especially if their amount exceeds the acceptable standards, can become a danger to the human body.

The dynamically developing industry and automotive industry adversely affect components of the biosphere, i.e. water, air and soil, causing systematic degradation of the natural environment. The negative influence of human activity factors on the soil is very long-lasting and often irreversible. The above phenomenon causes a quick loss of land used for agriculture.

Table 11.3 Potential soil pollution by various industries.

No.	Branch of the industry	Potential contamination of soil and ground with substances
1	Oil refineries, installations for the production of petroleum lubricants, Installations for gasification and liquefaction of coal or bituminous shale, plants Mining of hydrocarbon extraction with boreholes, coking plants	Aliphatic hydrocarbons, polycyclic aromatic hydrocarbons, Phenols, cresols
2	Seaports and port installations for handling crude oil and products Petroleum and other chemical cargoes and metal ores	Hydrocarbons Aliphatic, gasoline; Polycyclic aromatic hydrocarbons, pesticides and other impurities Organic, heavy metals
3	Chemical plants that produce organic products from chemical processing Coal	Aliphatic hydrocarbons, polycyclic hydrocarbons Aromatic, phenols, cresols, cyanides
4	Plastic plants, adhesives, resin and polymer production	Phthalates, Phenols, cyclohexane, chlorinated hydrocarbons
5	Production of paints, solvents and varnishes	Aromatic hydrocarbons, Chlorinated hydrocarbons, zinc, lead, chromium and barium
6	Substations and power substations	Polychlorinated biphenyls
7	Conventional power plants, combined heat and power plants and other combustion installations	Polycyclic aromatic hydrocarbons, heavy metals
8	Smelting plants for pig iron and steel and production of non-ferrous metals,	Heavy metals, cyanides, phenols, aliphatic hydrocarbons, polycyclic hydrocarbons Aromatic hydrocarbons
9	Ceramic plants	Cadmium, lead
10	Plants related to the production of lamps and measuring devices	Mercury
11	Galvanizing plants, plants producing and coating wire and cables	Heavy metals And cyanides
12	Investments related to the use or disposal of waste Dangerous and related to the thermal treatment of waste	Pesticides, aliphatic and aromatic hydrocarbons, polycyclic hydrocarbons Aromatic hydrocarbons, heavy metals

Continued

Table 11.3 Continued

No.	Branch of the industry	Potential contamination of soil and ground with substances
13	Chemical plants for the production of pesticides, pesticide warehouses and burial sites	Pesticides
14	Rubber production	Lead, tetrahydrofuran
15	Tanneries	Chromium, mineral salts, organic sewage
16	<i>Produkcja styropianu</i> Production of expanded polystyrene	Styren styrene
17	Liquid fuel stations, transport bases, large vehicle service stations, parking lots Car or parking lots	Aliphatic hydrocarbons – oils Mineral, gasoline, polycyclic aromatic hydrocarbons
18	Construction and repair facilities for ‘aircraft’, production and repair facilities Railway equipment, production plants for vehicles or equipment Mechanical and engine production	Aliphatic hydrocarbons, Polycyclic aromatic hydrocarbons, heavy metals

Based on: Stuczyński, T., Siebielec, G., Maliszewska-Kordybach, B., Smreczak, B., Gawrysiak L., 2004. Wyznaczanie obszarów, na których przekroczone są standardy jakości gleb, poradnik metodyczny dla administracji. Biblioteka Monitoringu Środowiska, Warszawa.

Depending on the nature and degree of identified pollution, remediation methods are set individually for a specific site. However, the remediation process is always very expensive. In highly contaminated areas, physical and chemical methods of soil cleaning are preferred. In addition to the phytotoxicity of pollutants, this is probably also supported by the fact that pollution of ground or underground water often appears after soil contamination.

Remediation activities (physical and chemical methods) can therefore be applied comprehensively with respect to the soil and water in a more controlled manner and provide faster results. However, the possibility of bioremediation as supporting conventional remediation processes – should not be excluded.

Chemical and physical methods besides generating high costs can also irreversibly affect soil properties, destroying their biological life, biodiversity and making them useless as an environment of plant growth (Padmavathiamma and Li, 2007).

11.4 The results

11.4.1 Results of reclamation work

In each year of the project related to the reclamation of lignite open-cast mine areas, soil analysis was conducted to determine the progress in reclamation. Analyzing the soil, the content of nutrients such as nitrogen, phosphorus, potassium, magnesium, manganese, zinc, copper, boron, sulphur as well as and the pH of the soil was determined. All tests were carried out in accordance with the applicable standards. Below, a comparison of data before reclamation and derived from studies from the last year of work.

Before starting the reclamation, the content of boron in the recultivated fields was low. As a result of the reclamation (remediation), the level of boron increased to medium. The copper content was on an average level throughout the reclamation period. Similarly, the iron and manganese content was on an average level. The content of zinc as a result of reclamation increased the level of potassium on reclamation sites before the start of work varied from low to medium (Figs 11.1–11.9, based on the IWNiRZ research).

As a result of the reclamation, the potassium content in the soil increased to very high level. Before reclamation, the magnesium content varied widely (from medium to very high). As a result of reclamation, it stabilized at a very high level. The phosphorus level increased from very low to very high. The sulphur content in the soil was at a very high level. Recultivated areas were characterized by alkaline pH of the soil.

Both in the case of fibrous hemp and alfalfa there was noticed and reported a significant increase in the biomass yield. In 2016, when in Poland drought occurred,

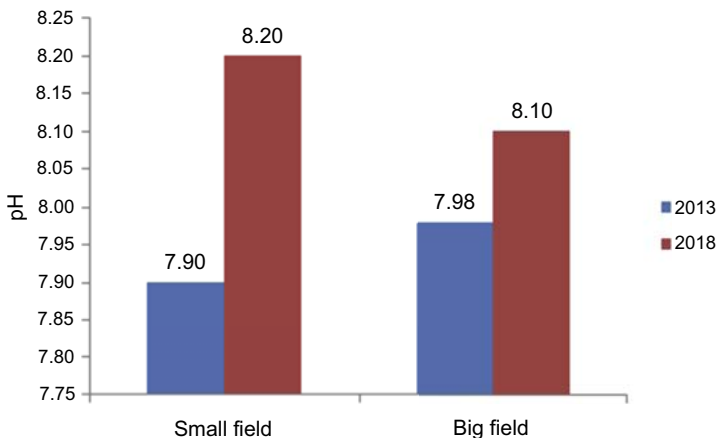

Figure 11.1 pH of soil from recultivated areas, 2013 and 2018.

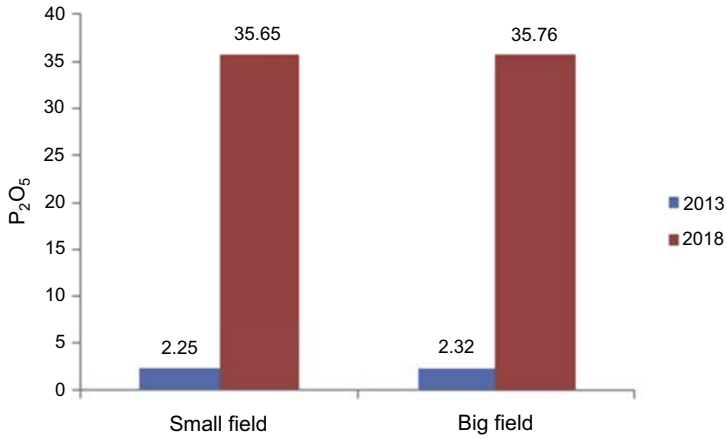

Figure 11.2 Phosphorus content (mg/100 g) of soil from recultivated areas, 2013 and 2018.

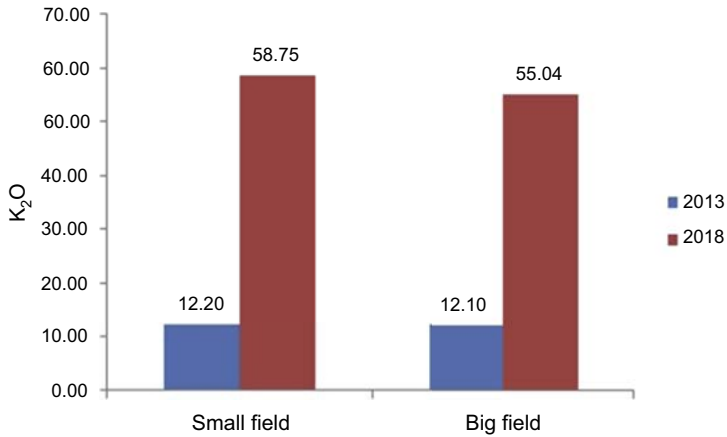

Figure 11.3 Potassium (K) content (mg/100 g) of soil from recultivated areas, 2013 and 2018.

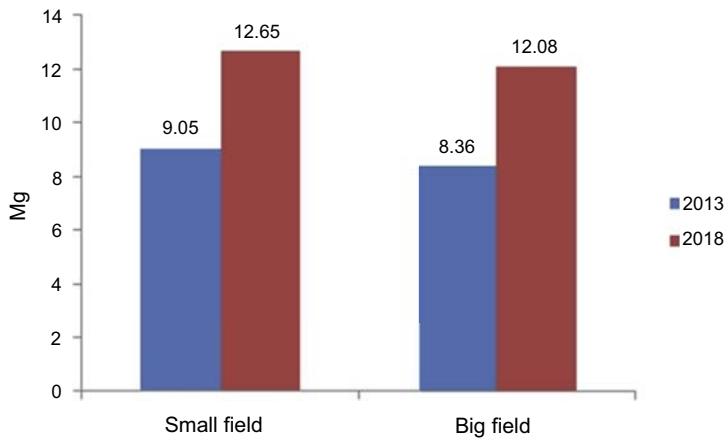

Figure 11.4 Magnesium (Mg) content (mg/100 g) of soil from recultivated areas, 2013 and 2018.

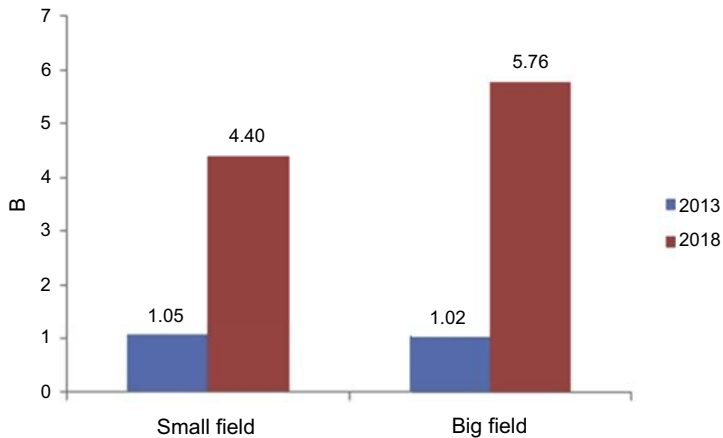

Figure 11.5 Boron (B) content (mg/1000 g) of soil from recultivated areas, 2013 and 2018.

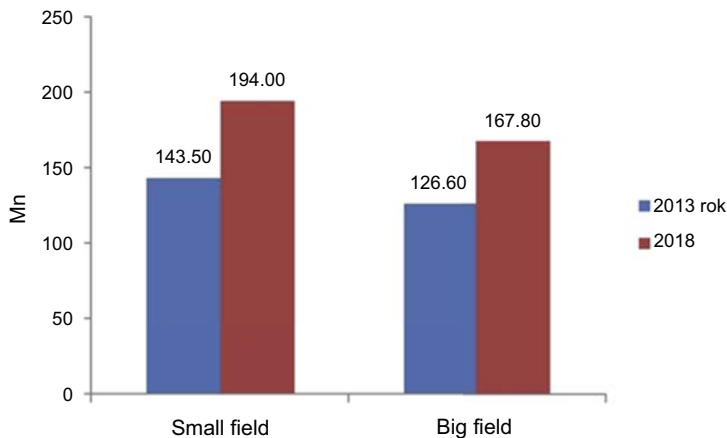

Figure 11.6 The content of manganese (Mn) (mg/1000 g) of soil from recultivated areas, 2013 and 2018.

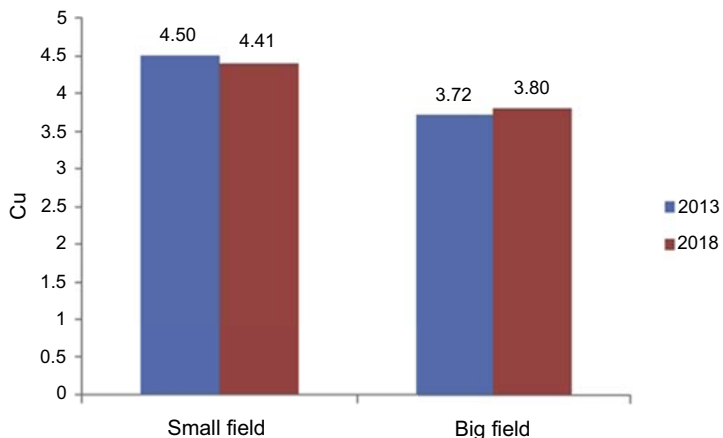

Figure 11.7 Copper (Cu) content (mg/1000 g) of soil from recultivated areas, 2013 and 2018.

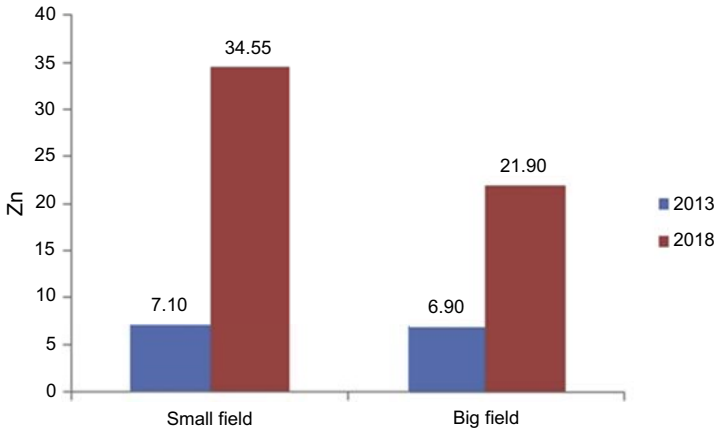

Figure 11.8 Zinc (Zn) content (mg/1000 g) of soil from recultivated areas, 2013 and 2018.

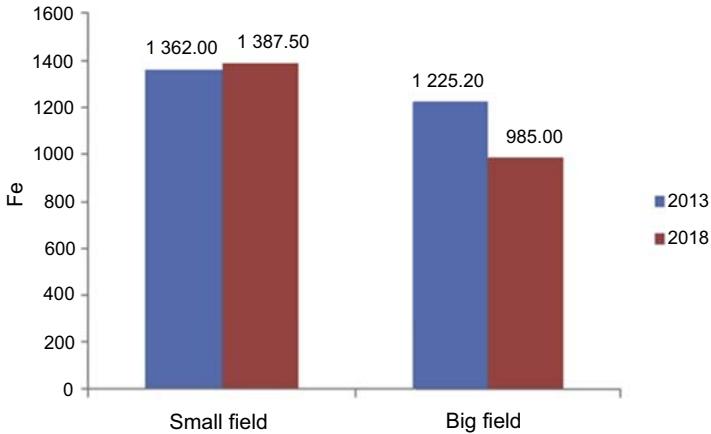

Figure 11.9 Iron (Fe) content (mg/1000 g) of soil from recultivated areas, 2013 and 2018.

fibrous hemp and alfalfa which are characterized by a well-developed deep root system, perfectly coped with unfavourable weather conditions. In 2016, the field rotation was applied. It was the first year of alfalfa cultivation on the fields after fibrous hemp, cultivation, hence the lower yield of alfalfa plant were noticed. However, this yield was higher than alfalfa yield in the first year of reclamation.

In 2017, hemp crop suffered due to long-lasting intense rainfall. A large amount of precipitation in the period immediately after emergence led to the loss of many plants. Due to the compact, impermeable recultivated layer, even slight rainfall led to the formation of large water stalls. The standing water displaced oxygen from the soil which led to the suffocation of many plants (Table 11.4).

The recultivation carried out using the agricultural method of cultivation, applying the fibrous hemp and alfalfa crop rotation and subsequent ploughing of plant biomass resulted in an increase in the level of humus on the reclaimed site during the 6-year research period (Mańkowski. et al., 2018) (Table 11.5).

Table 11.4 Average amount of biomass obtained from reclamation areas (kg/ha).

Plant	Stanowisko Habitat	Years					
		2013	2014	2015	2016	2017	2018
Fibrous hemp	Small field (9 ha)	2500	2300	6300	6800	5000	6900
	Big field (16 ha)	1800	1600	5300	5900	3500	6300
alfalfa	Small field (9 ha)	1040	4800	5600	2500	6600	7200
	Big field (16 ha)	840	4200	5500	2400	6550	7000

Table 11.5 The maximum and minimum level of humus specified in the areas reclaimed from 2013 to 2018.

Field	Sample	Level of humus (%)					
		2013 (before remediation)	2014	2015	2016	2017	After project termination
1	Min.	1.30	1.91	1.10	3.10	1.03	2.41
	Max.	1.51	2.16	2.20	3.20	2.41	2.41
2	Min.	0.76	0.75	0.80	0.60	1.90	2.24
	Max.	1.49	1.77	1.20	1.20	2.93	2.59

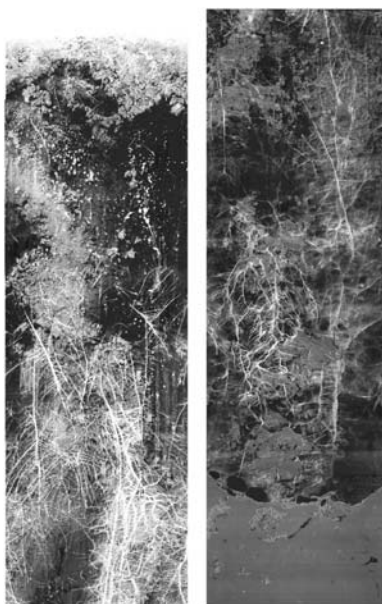

1.

2.

Picture 11.6 The root system of fibrous hemp (1) and alfalfa (2) cultivated in reclaimed areas.

The roots of hemp and alfalfa overgrown to a depth of over 100 cm, have expanded to a large extent and ventilated, aerated and scarified the recultivated soil.

There was noticed a significant difference in the behaviour of the root system of fibrous hemp grown in the post-mining areas in relation to agricultural areas. Hemp having a pile type root system, in agricultural areas has grown deeper than in post-mining lands, where the roots, due to the compact layer of the soil, formed a larger mass in the topsoil.

α -*Proteobacteria* is a fairly diverse group of microorganisms. Most of them are Gram-negative bacteria. The microorganisms classified in the genus *Rhizobium* and *Bradyrhizobium* are of particular importance from the agricultural point of view, symbiotic bacteria (with legumes – including alfalfa) capable of assimilating atmospheric nitrogen. The presence of the proper host plant in the field habitats is an element strongly stimulating the increase in the population size of the relevant microsymbionts present in the soil. The increase in the number of this group of bacteria was observed at all sites covered by reclamation according to the developed method (Figs 11.10–11.15).

β -*Proteobacteria* covers a range of groups of aerobic or facultatively aerobic bacteria. They differ quite significantly in the scope of organic matter decomposition, but many of them are important in the processes of assimilating atmospheric nitrogen by several agricultural crops (e.g. *Nitrosomonas*). On the examined objects in the last 3 years of the field experiment, the number of this group of microorganisms increased the most in all the habitats of the large field (initially much poorer compared to the small field).

The reversal of the unfavourable trend of limiting the population of this group of microorganisms, observed in previous years, may be gratifying. This is particularly evident in the large field (PD) sites, which are characterized by less homogeneous soil-forming processes compared to the small fields (PM), where the agrotechnical reclamation was carried out even before the start of the research.

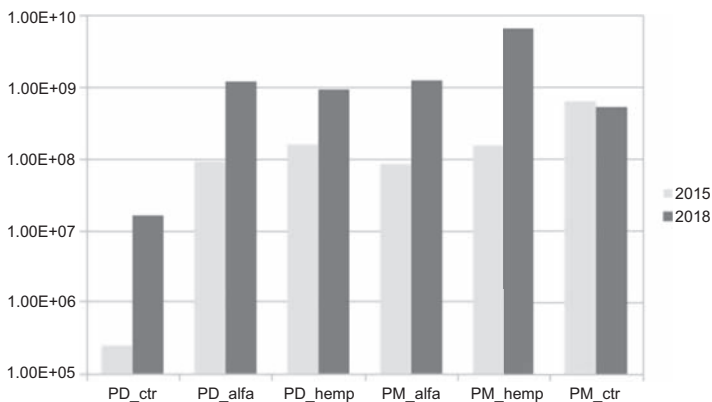

Figure 11.10 Population of α -Proteobacteria population in 2015 and 2018 at field sites.

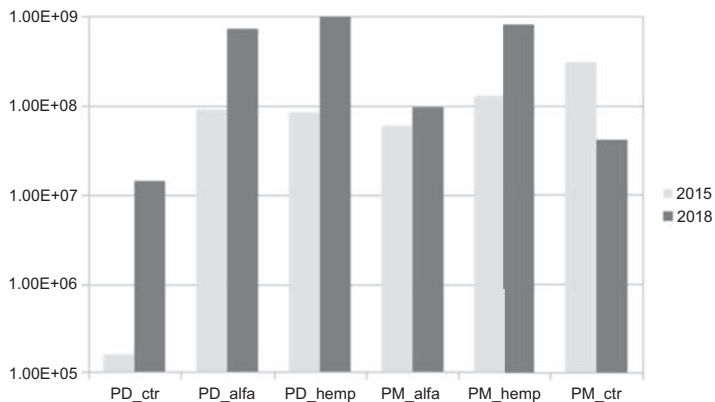

Figure 11.11 The size of the β -Proteobacteria population in 2015 and 2018 at field sites.

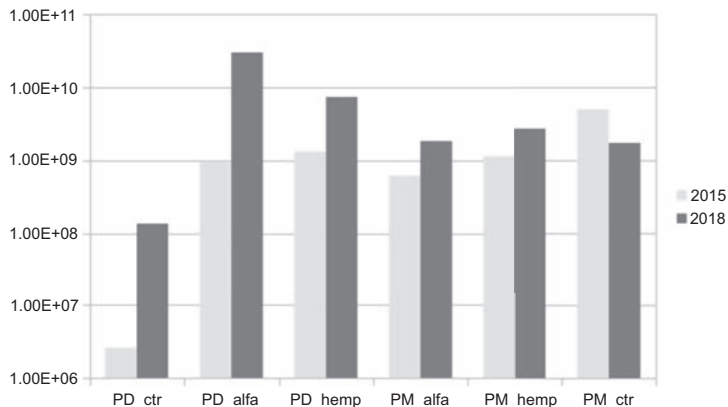

Figure 11.12 Population of the *Actinobacteria* population in 2015 and 2018 in field positions.

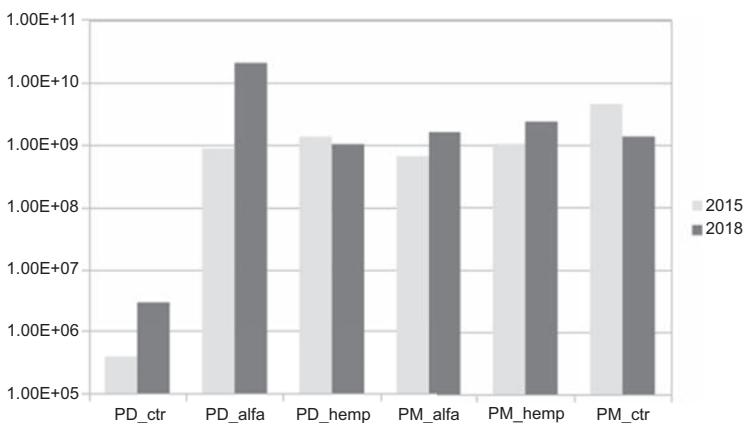

Figure 11.13 The population numbers of *Firmicutes* in 2015 and 2018 in field positions.

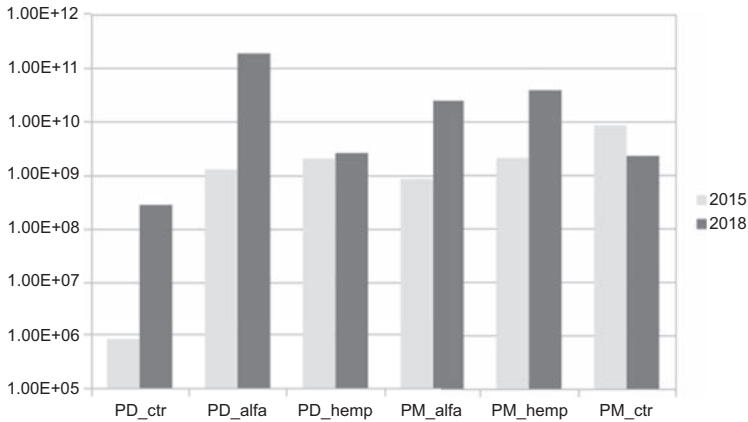

Figure 11.14 Population of the *Bacteroidetes* population in 2015 and 2018 at field sites.

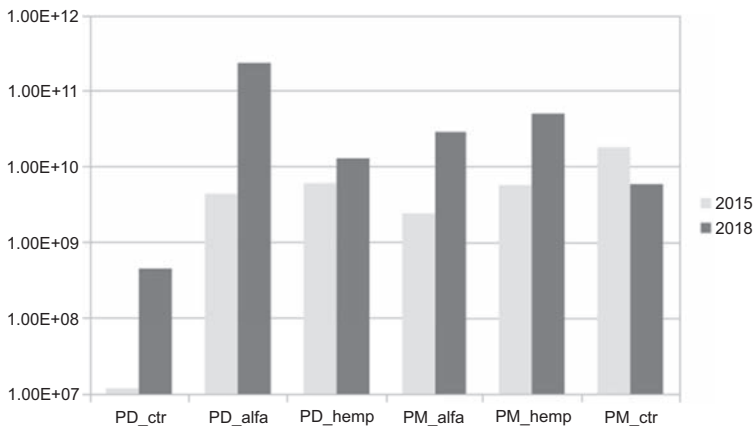

Figure 11.15 Total number of bacterial populations in 2015 and 2018 at field sites.

The proportion of two successive analyzed groups of microorganisms i.e. *Actinobacteria* (actinomycetes) and *Firmicutes*, was significantly higher than that of *Proteobacteria* and reached 30% or even over 50% (PD_hemp site) and the total pool of bacteria. Actinomycete are prokaryotic organisms that form a row of Gram-positive bacteria whose main location is soil. They are characterized by very good adaptability to the prevailing environmental conditions. They also occur in the roots of plants, fallen leaves and even in desert sand.

Both groups (*Actinobacteria* and *Firmicutes*) contribute to the decomposition of plant and animal residues, polysaccharides and hardly decomposable compounds, such as cellulose, chitin, higher fatty acids and aromatic compounds. On the objects studied, a clearly beneficial effect of reclamation on the share of the population of these two groups in the total pool of bacteria was observed regardless of the plant cultivated. Particular attention is paid to a significant increase in the number of actinoblasts

(*Actinobacteria*) on less recultivated PD fields. This may indicate that the effect of the organic matter introduced systematically on the number of population capable of decomposing plant remains has been stimulated after 6 years of project activities.

The next analyzed group, with the highest percentage share in the bacterial pool, were microorganisms classified within the *Bacteroidetes* area. This group is gram negative, often anaerobic bacteria. This is also a diverse taxon encompassing microorganisms that inhabit very different locality from soil and sewage sludge to seawater and animal digestive tracts.

Such a large representation of the bacteria belonging to this group in the studied objects indicates the continuing difficult air-water relations on the analyzed sites and the excessive anaerobic conditions with the availability of nutrients coming from the introduced organic matter already in comparison with control objects.

The graph above shows changes in the population size of soil microflora on the investigated sites. The increase in the number of bacteria observed on all reclaimed objects indicates the unambiguously beneficial effect of cultivation and conducted tillage procedures on the recultivated sites for the total number of soil microorganisms and the structure of their population in comparison with the control. The general beneficial effect of cultivation was more clearly visible on the initially less reclaimed large field facilities, however, the beneficial effect of the cultivation operations was also noted at small field sites (PM) (Pudełko et al., 2014).

Remediation results of contaminated soils.

The highest concentrations of heavy metal impurities in soils usually show a humus level, which is related to the affinity of these elements to organic matter (Kabata-Pendias and Pendias, 1993; Motowicka-Terelak and Terelak, 2002; Maciejewska, 2003; Rosada, 2008). From among the whole range of possible contaminants, the most investigated and the most popular form of applying plants in phytoremediation processes is the extraction of heavy metals from the substrate, the so-called phytoextraction.

Due to the special features of hemp (Kumar et al., 1995) i.e. high ability to accumulate metals in aboveground parts of the plant, rapid biomass growth, local origin, resistance to diseases, pests and weather whims, the possibility of growth on contaminated and degraded areas and the possibility of collecting more than one trace element from the soil, Antonkiewicz (2013) recommends fibrous hemp *Cannabis sativa* L. as one of the plants recommended for phytoremediation of soils.

Comparative studies of the phytoremediation potential of plants performed at the end of the 1990s (Grzebisz et al., 1998) confirmed that the content of heavy metals in hemp depended on the analyzed element. Cadmium accumulated in aboveground parts of hemp in an amount almost three times greater than in roots. In addition, hemp showed a much greater affinity to pick up lead and copper from the ground. Analyses of the Pb and Cu contents extracted from the contaminated soil with biomass gave the basis for the conclusion that among bast plants *Cannabis sativa* L. can play a significant and key role in phytoremediation processes of heavily contaminated soil (Antonkiewicz and Jasiewicz, 2002).

A study published in 2009 regarding the impact of cadmium soil contamination on biomass growth including the roots of industrial plants (Gangrong and Qingsheng,

2009) showed that at low concentrations of Cd (50 mg/kg) no reduction in root growth was observed for all tested plants, including hemp. Soil treatment with a dose of 100 mg/kg Cd suppressed root growth in six out of eight experimental crops. The exception was rapeseed and hemp. High doses of Cd (200 mg/kg) resulted in significantly reduced root growth of all species of studied plants (the most sunflower – by 47%, hemp – by 43%, flax – by 32%). Under the same conditions, the content of Cd in soil (200 mg/kg) in all tested plant species, with the exception of cannabis, the shoot length decreased with a gradual increase in the Cd concentration in the soil. At the Cd concentration limit of 200 mg/kg, the reduction in shoot length was also observed in flax (35%) and then in hemp (43%) (49% for soybeans) and peanut (58%).

Hemp to a certain point is characterized by tolerance to cadmium content. Only high concentrations of this element lead to impairment of the plant growth process and to the decrease of biomass production.

The research conducted at the Institute of Natural Fibres and Medicinal Plants (IWNiRZ) showed that fibrous hemp compared to the cultivation of legume plants shortened the reclamation carried out by half, and the content of heavy metal ions in reclamation soil decreased by 80% after 3 years of reclamation.

The research concerned agricultural development of contaminated areas through the cultivation of industrial plants. The introduction of fibrous plants for technical purposes into areas contaminated by civilization factors has led to their gradual remediation and restoration of the agricultural nature of their utilization.

The non-food nature of crop rotation has eliminated heavy metals from the human food chain and the obtained biomass of fibrous plants could be used in ecological production by the textile, pulp and paper, chemical or fuel-energy industry.

The research showed that the plants were growing properly, did not get sick, and the presence of heavy metals in the soil did not adversely affect the yield (Table 11.6).

The obtained results show that the highest concentrations of metals, and therefore their strongest extraction, were found in hemp. Also for flax and oil flax the level of extraction is higher than for the compared crop plants. The high biomass of fibrous hemp yield accumulates significant amounts of heavy metals (Table 11.7).

The introduction of fibrous plants devoted for technical purposes into areas contaminated by civilization factors leads to their gradual remediation. The selected plant is fibrous hemp *Cannabis sativa* L., which is not negatively influenced by the presence of heavy metals in the soil. Plants on such soils do not get sick and develop properly (Baraniecki et al., 1995; Kozłowski et al., 1993).

Table 11.6 The content of Cu, Pb, Zn and Cd in seeds in mg/kg s.m.

Element	Hemp	Fibrous flax	Linseed	Triticale	Oat
Cu	26.2	15.9	10.0	5.7	3.5
Pb	1.7	1.0	0.1	2.8	1.0
Zn	77.0	74.7	77.0	18.3	19.0
Cd	0.20	0.30	0.40	0.05	0.10

Table 11.7 The content of metals in plant stems.

Element	Hemp	Fibrous flax	Linseed	Triticale	Oat
Cu	72.6	4.1	5.7	20.9	7.8
Pb	20.0	2.0	1.0	12.9	7.4
Zn	64.9	27.3	23.7	12.4	7.3
Cd	0.3	0.6	0.4	0.1	0.1

11.5 Future trends

The process of phytoremediation of soils with the use of hemp can allow, on the one hand, extraction of harmful substances from the soil and parallel use of plants for energy purposes, e.g. for the production of bioethanol, biogas or possibly oil production for energy purposes from oil varieties (Kabata-Pendias and Pendias, 1993). Phytoremediation is considered a relatively new method of soil cleaning, and sewage sludge in situ.

Studies on the assimilation of lead and cadmium in the phytoremediation process using hemp sowing showed an increase in the amount of trace elements extracted while supporting the remediation process with appropriate doses of urea and EDTA (acidum edeticum). The best effects of the extraction of elements were obtained using (in the reported experiments) the ratio of Urea – 2.500 ppm with EDTA – 100 ppm (increased values of T4 urea). The study showed greater plant growth, increased biomass production and much more effective uptake of Pb and Cd by various parts of the plant (Astel et al., 2014).

Genetic studies carried out by scientists in Pakistan using fibrous hemp (Ahmad et al., 2015) have shown that the level of accumulation of metallic elements in a plant (Cu, Cd, Ni) correlates with the presence of specific genes responsible for the tolerance level of stress in the plant. This discovery brings a new light for the further development and improvement of the phyto-accumulative and extraction capabilities of hemp. Therefore, interference with the genetic code of a plant is not excluded, as a result of which a variety resistant to very high concentrations of heavy metals in soil or ground will be created, and, at the same time, it will allow the growth of phytoremediation potential of new industrial hemp varieties.

The work carried out by Sonia Campbell et al. (2002) on an attempt to remedy soil contaminated with polycyclic aromatic hydrocarbons (PAHs) also showed that hemp may also be useful in phytoremediation of PAHs. The growth rate of hemp in soils contaminated with chrysene and benzopyrene in concentrations from 25 to 200 µg/g was satisfactory, and PAH pollution was reduced.

Research is being carried out on the resistance of some plants, including hemp for cultivation on saline soils e.g. the HaloSYS project – ‘Integrated system of bioremediation – biorefining using halophyte species’ is being implemented at IWNiRZ. Due to the increase in population and industrialization in the world, the reclamation of soils with biological methods will become more and more important.

11.6 Conclusion

The phenomena of soil degradation and contamination have a spatial dimension, and should therefore be documented and analyzed in a quantitative way using appropriate databases, models and algorithms that interact with geographic information systems (Stuczyński et al., 2004).

Soil-forming processes are very long-lasting; they last for at least several hundred years. Experiments carried out in just a few years, conducting remediation of post-mining areas, showed a positive effect of hemp and alfalfa cultivation on the initiation of soil-forming processes and a gradual improvement of the fertility of the initial substrate. Hemp also proved to be a plant capable of absorbing heavy metals from degraded soils.

High resistance of plants to diversified weather condition, diseases and pathogens, reasonable agrotechnical and fertilizing requirements, relatively low maintenance costs of phytoremediation *Cannabis sativa* L. plantation, and finally the possibility of industrial biomass use create hemp a leader in phytoremediation among domestic industrial plants e.g. in Poland.

The presence of heavy metals in the soil does not adversely affect the development and yield of fibrous plants. The content and distribution of heavy metals in particular parts of plant varies and depends mainly on the plant species and the concentration of heavy metals in the soil. The highest concentration of Cu was found in the seeds, whereas Pb in the stems and then in the fibre.

References

- Ahmad, R., Tehsin, Z., Malik, S.T., Ahmad Asad, S., Shahzad, M., Bilal, M., Shah, M.M., Khan, S.A., 2015. Phytoremediation Potential of Hemp (*Cannabis sativa* L.): Identification and Characterization of Heavy Metals Responsive Genes. Article in CLEAN - Soil Air Water.
- Alloway, B.J., 1990. Cadmium. In: Alloway, B.J. (Ed.), Heavy Metals in Soils. Blackie and Son Ltd., Glasgow.
- Antonkiewicz, J., 2013. Fitoremediacja gleb zanieczyszczonych metalami ciężkimi. Gdańsk.
- Antonkiewicz, J., Jasiewicz, C., 2002. Ocena przydatności różnych gatunków roślin do fitoremediacji gleb zanieczyszczonych metalami ciężkimi. *Formatio Circumiectus* 1–2 (1–2), 119–130.
- Astel, A., Czyżyk, A., Parzych, A., 2014. Fitoremediacja metodą obniżania toksyczności gleb zanieczyszczonych metalami ciężkimi, Akademia Pomorska, Zakład Chemii Środowiskowej, Instytut Biologii i Ochrony Środowiska. Lab 4.
- Baraniecki, P., Grabowska, L., Mańkowski, J., 1995. Len i konopie na terenach zdegradowanych przez przemysł miedziowy, Flax and hemp in areas made derelict by the copper industry, vol. XXXIX. *Natural Fibres*, pp. 79–86. ISSN 1230-4476.
- Campbell, S., Paquin, D., Jonathan, D., Awaya & Qing, X.L., 2002. Remediation of benzo(a)pyrene and chrysene-contaminated soil with industrial hemp (*Cannabis sativa* L.). *Int. J. Phytoremediation* 4 (2), 157–168. <https://doi.org/10.1080/15226510208500080>.

- Gangrong, S., Qingsheng, C., 2009. Cadmium tolerance and accumulation in eight potential energy crops. *Biotechnol. Adv.* 27, 555–561.
- Grzebisz, W., Potarzycki, J., Cieśla, L., 1998. Ekstrakcja metali ciężkich przez rośliny włókniste z gleb zanieczyszczonych emisjami huty miedzi. Cz. II. *Len. Zesz. Probl. Post. Nauk Rol.* 460, 697–708.
- Kabata-Pendias, A., Pendias, H., 1993. *Biochemistry of Trace Elements*. PWN Warszawa, pp. 137–149.
- Kabata-Pendias, A., Pendias, H., 1999. *Biogeochemia pierwiastków śladowych*. PWN, Warszawa, pp. 380–398.
- Karczewska, A., 2008. Ochrona gleb i rekultywacja terenów zdegradowanych, pp. 189–270. Wrocław.
- Kozłowski, R., Grabowska, L., Mścisz, J., 1991. Zagospodarowanie rejonów skazonych przez przemysł roślinami niekonsumpcyjnymi. *Natural Fibres*.
- Kozłowski, R., Grabowska, L., Baraniecki, P., Mścisz, J., 1993. Recultivation by Flax and Hemp Culture of Soil Polluted by Heavy Metals. *Natural Fibres*, Poznań.
- Kumar, P.B.A.N., Dushenkov, V., Motto, H., Raskin, I., 1995. Phytoextraction: the use of plants to remove heavy metals from soils. *Environ. Sci. Technol.* 29, 1232–1238.
- Maciejewska, A., 2003. Problematyka rekultywacji gleb zanieczyszczonych metalami ciężkimi w świetle literatury. 539-550. W: "Obieg Pierwiastków w Przyrodzie". Monografia Tom II. (B. Gworek, J. Misiak red.). Dział Wydawnictw IOŚ, Warszawa, 730 ss., ISBN 83–85805–90–7.
- Mańkowski, J., Kołodziej, J., Kubacki, A., Baraniecki, P., Pniewska, I., Pudełko, K., 2014. Cultivation of Industrial Hemp Accelerating Reclamation of Land Degraded by Open Mining of Lignite. *Chemik, nauka, technika, rynek* nr 11.
- Mańkowski, J., Baraniecki, P., Kołodziej, J., Pudełko, K., Kubacki, A., Pniewska, I., 2017a. Remediation of lignite post-mining areas by cultivation of industrial hemp (*Cannabis sativa* L.). In: *Book of Abstracts 5th International Exergy, Life Cycle Assessment & Sustainability Workshop & Symposium*.
- Mańkowski, J., Kołodziej, J., Baraniecki, P., Maksymiuk, W., Kubacki, A., Pniewska, I., Pudełko, K., 2017b. Remediacja, rekultywacja i rewitalizacja. Monografia pod redakcją Prof. Grzegorza Maliny, Poznań.
- Mańkowski, J., Kołodziej, J., Kubacki, A., Baraniecki, P., Pniewska, I., Pudełko, K., 2018. Wykorzystanie konopi włóknistych do rekultywacji i zwiększenia żyzności gleb zdegradowanych – projekt LIFE11 ENV/PL/445; Remediacja, rekultywacja i rewitalizacja, red. Prof. G. Malina, Poznań, pp. 67–84, 978-83-64959-05-9.
- Motowicka-Terelak, T., Terelak, H., 2002. *Gleboznawstwo ekologiczne*. Wyd. Wszech. Mazurskiej, Olecko, 83–86523–64.
- Padmavathamma, P., Li, L.Y.L., 2007. Phytoremediation technology; hyperaccumulation metals in plant, water, air. *Soil Pollution* 184, 105–126.
- Pudełko, K., Mańkowski, J., Kołodziej, J., 2014. Diversity of soil microorganisms on the fields reclaimed after mining operations in the Konin area. In: *19 International Conference for Renewable Resources and Plant Biotechnology NAROSSA 2014* (mat. konferencyjne).
- Rosada, J., 2008. Stan środowiska rolniczego w rejonie oddziaływania emisji Huty Miedzi GŁOGÓW. *Rozprawy Naukowe Instytutu Ochrony Roślin. Państwowego Instytutu Badawczego. Zeszyt 19*.
- Rosada, J., Chudziński, B., Nijak, K., 1995. Zanieczyszczenie roślin uprawnych metalami ciężkimi pochodzącymi z gleby oraz bieżącej emisji Huty Miedzi "Głogów". s. 236–243. W: *Mater. 35 Ses. Nauk. Inst. Ochr. Rośl., cz. 1 Referaty*.

- Siebielcec, G., Stuczyński, T., Trelak, H., Filipiak, K., Koza, P., Korzeniowska –Puculek, R., Łopatka, A., Jadczyżsyn, J., 2008. Uwarunkowania produkcji rolniczej w regionach o dużym udziale gleb zanieczyszczonych metalami śladowymi. *Studia i Raporty IUNG- PIB. Zeszyt 12.*
- Stuczyński, T., Siebielec, G., Maliszewska-Kordybach, B., Smreczak, B., Gawrysiak, L., 2004. Wyznaczanie obszarów, na których przekroczone są standardy jakości gleb, poradnik metodyczny dla administracji. Biblioteka Monitoringu Środowiska, Warszawa.

Sources of further information and advice

- Albasel, N., Cottenie, A., 1985. Heavy metals uptake from contaminated soils as affected by peat, lime and chelates. *Soil Sci. Soc. Am. J.* 49.
- Alloway, B.J., 1995. Soil processes and the behaviour of metals. In: Alloway, B.J. (Ed.), *Heavy Metals in Soils*, second ed. Blacjie, Glasgow.
- Alloway, B.J., Morgan, H., 1986. The behaviour and availability of Cd, Ni and Pb in polluted soils. In: Assink, J.W., van den Brink, W.J. (Eds.), *Contaminated Soils*, Dordrecht, the Netherlands.
- Angeli, M.G., Pasuto, A., Silvano, S., 2000. A critical review of landslide monitoring experiences. *Eng. Geol.* 55, 3.
- Baraniecki, P., Mańkowski, J., 1995. Hemp Fibre as a Raw Material for Paper Production in the Aspect of Natural Environment Protection. *Agricultural Engineering*, Praha.
- Bradshaw, A., 2000. The use of natural processes in reclamation - advantages and difficulties. *Landscape Urban Plan.* 51.
- Brümmer, G., Herms, U., 1983. Influence of soil reaction and organic matter on the solubility of heavy metals in soils. In: Ulrich, B., Pankraht, J. (Eds.), *Effects of Accumulation of Air Pollutants in Forest Ecosystems*. D. Reidel Publ. Company, pp. 223–243.
- Christensen, T.H., 1989. Cadmium soil sorption at low concentrations: VIII. Correlation with soil parameters. *Water, Air Soil Pollut.* 44.
- Evangelou, M.W.H., Ebel, M., Schaeffer, A., 2007. Chelate assisted phytoextraction of heavy metals from soil. Effect, mechanism, toxicity, and fate of chelating agents. *Chemosphere* 68.
- Higgs, E.S., 1997. What is good ecological restoration? *Conserv. Biol.* 11.
- Jadia, C.D., Fulekar, M.H., 2009. Phytoremediation of heavy metals: recent techniques. *Afr. J. Biotechnol.* 8.
- Kabała, C., Chodak, T., Szerszeń, L., Karczewska, A., Szopka, K., Frątczak, U., 2009. Factors influencing the concentration of heavy metals in soils of allotment gardens in the city of Wrocław, Poland. *Fresenius Environ. Bull.* 18 (7).
- Karczewska, A., Chodak, T., Kaszubkiewicz, J., 1996. The suitability of brown coal as a sorbent for heavy metals in polluted soils. *Appl. Geochem.* 11.
- Karczewska, A., Bogda, A., Kurnikowska, B., 2001. Nickel, chromium, lead and cadmium in soils and common plant species in the area of nickel mining and smelting (Szklary, SW Poland). In: *Proc. 6th ICOBTE; Guelph 2001.*
- Karczewska, A., Bogda, A., Gałka, B., Szulc, A., Czwarciak, D., Duszyńska, D., 2006. Natural and anthropogenic soil enrichment in heavy metals in the areas of former metallic ore mining in the Sudety Mts. *Polish. J. Soil Sci.* 39, 2.
- Kasztelewicz, Z., 2018. Raport o stanie branży węgla brunatnego w Polsce i w Niemczech wraz z diagnozą działań dla rozwoju tej branży w I połowie XXI wieku. Kraków.

- Kononowa, M., 1966. Soil Organic Matter. Pergamon, Oxford.
- Lo, I.M.C., Yang, X.Y., 1999. EDTA extraction of heavy metals from different soil fraction and synthetic soils, water. *Air Soil Pollut.* 109 (1–4).
- Luo, C.H., Yang, R., Wang, Y., Li, Y., Zhang, G., Li, X., 2012. Influence of agricultural practice on trace metals in soils and vegetation in the water conservation area along the East River (Dongjiang River), South China. *Sci. Total Environ.* 431.
- Maciejewska, A., 1998. Effect of organo-mineral fertilizer obtained from brown coal on absorption of Zn, Pb, Cd by various types of plants. In: Second Internet. Symp. "Trace Elements and Food Cham" China-Wuhan.
- Mańkowski, J., Kubacki, A., Kołodziej, J., Baraniecki, P., Pniewska, I., 2013. Utilization of hemp fibre obtained from plants grown on remediated land. In: Book of Abstracts z International Conference on Natural Fibers, Sustainable Materials for Advanced Applications.
- Mańkowski, J., Kołodziej, J., Kubacki, A., Baraniecki, P., Pniewska, I., 2014. Cultivation of industrial hemp accelerating reclamation of land degraded by open mining of lignite. *CHEMIK* 2014 68, 11.
- Mańkowski, J., Kołodziej, J., Kubacki, A., Baraniecki, P., Pniewska, I., 2014. Cultivation of hemp accelerating remediation of post-mining land. In: 19 International Conference for Renewable Resources and Plant Biotechnology NAROSSA 2014.
- Mc Bride, M.B., 1994. Environmental Chemistry of Soils. Oxford University Press, New York, NY.
- Pichtel, J.R., Dick, W.A., Sutton, P., 1994. Comparison of amendments and management practices for long-term reclamation of abandoned mine lands. *J. Environ. Qual.* 23 (4).
- Qishlaqi, A., Moore, F., 2007. Statistical analysis of accumulation and sources of heavy metals occurrence in agricultural soils of Khoshk River Banks, Shiraz, Iran. *Am. Eurasian J. Agric. Environ. Sci.* 2 (5).
- Ross, S.M., 1994. Toxic Metals in Soil-Plant System. John Wiley and Sons Ltd. (red.), London.
- Simmons, J.A., Currie, W.S., Eshleman, K.N., et al., 2008. Forest to reclaimed mine land use change leads to altered ecosystem structure and function. *Ecol. Appl.* 18, 1.
- Terelak, H., Stuczyński, T., Piotrowska, M., 1997. Heavy metals in agricultural soils in Poland. *Pol. J. Soil Sci.* 30, 2.
- Wolt, J.D., 1994. Soil Solution Chemistry. Applications to Environmental Science and Agriculture. J. Wiley and Sons, New York.

This page intentionally left blank

Medical potential of cannabis: an overview

12

Dariusz Michał Zielonka¹, Łukasz Kiraga², Ryszard M. Kozłowski³

¹Warsaw University of Life Sciences, Autonomous Department of Microorganisms' Biology, Faculty of Agriculture and Biology, Warsaw, Mazowieckie, Poland; ²Warsaw University of Life Sciences, DVM Department of Physiological Sciences Faculty of Veterinary Medicine, Warsaw, Mazowieckie, Poland; ³Journal of Natural Fibres Editor-in-chief, coordinator of FAO/ESCORENA European Cooperative Research Network on Flax and other Bast Plants, former director of the Institute of Natural Fibres, Poznan, Poland

12.1 Plant biology

Cannabis sativa, a member of Cannabaceae family consisting 10 genera with approximately 100 species (Hartsel et al., 2016), is a plant with outstanding adaptive abilities (Chandra and Lata, 2017), known by mankind for millennia (Brand and Zhao, 2017; Chen et al., 2012), mainly as a source of fibre from aboveground shoots (both plant and fibre referred to as 'hemp') and a narcotic originating mainly from female plants (♀) (a plant and its preparations commonly referred to as 'cannabis' or 'marijuana'), and as a source of edible fruits — achenes (Chandra et al., 2017a). Human-influenced domestication of the species for these different purposes resulted in changes of morphology, chemotypes, distribution, and ecology of breeding forms as compared to related wild plants (Clarke and Merlin, 2016; Pollio, 2016).

Wild plants seem to be either form characterized by inbreeding depression (Soler et al., 2017) or the result of thousands of years of universal genetic exchange with domesticated plants, which makes impossible to determine the existence of the original, unchanged population (Lynch et al., 2016). The discussion on the subject of the botanical classification of medicinal *Cannabis*, including the division into several alleged species, subspecies, chemotypes, morphotypes, biotypes, ecotypes, takes place to this day (Lewis et al., 2018; Pollio, 2016; Small, 2018; Watts, 2006). Some suggest distinguishing it as a single species in which there is a subspecies with a high concentration of THC and its domesticated and ruderal varieties, as well as the subspecies with low THC content and its domestic and ruderal varieties. Others distinguish high morphotypes with narrow leaflets, characterized by a chemotype with a relatively high THC content towards CBD and low morphotypes with broad leaflets and more frequent internodes and opposite to previous, having high THC and CBD contents (McPartland and Guy, 2017).

The geographical and ecological range of *Cannabis sativa* occurrence is vast, and the cultivated populations grow on all continents, except Antarctica, in a wide range of environments, from subarctic and moderate to tropical, from sea level to over 3000 m (Lynch et al., 2016). Wild populations also occur in the north, at the tip of the Arctic

Circle in Eurasia (Chandra et al., 2017b), but most often on well-drained soils of temperate continental ecosystems in Eurasia and North America. The species is characterized by extensive phytochemical diversity, especially in cannabinoid and terpenoid profiles (Massimino, 2017; Russo, 2011), and also shows a wide variety of morphological features and life history, further fuelling the debate on the taxonomic status and origin of the plant's domestication (Sawler et al., 2015).

Cannabis is called as a 'short day plant'. Such plants naturally begin flowering at the end of summer in response to the increase in night length (Hall et al., 2014). Over the past decade, the increasing number of so-called 'auto-flowering' varieties has become available on the market. These plants are not dependent on photoperiod and begin flowering in about 2 weeks of age, regardless of the length of the day. They can be grown in constant lighting, producing very high yields (Russo and Marcu, 2017b).

12.1.1 Sex dimorphism

Dioecy occurs in about 6% of the flowering plant species, of which only a small number of species has evidenced cytogenetic or molecular sex chromosomes (Vyskot and Hobza, 2015). In contrast to animals in which the dimorphism of the sex chromosomes often accompanies dioecism, it is believed that sex chromosomes have repeatedly evolved independently in plants, suggesting the recent appearance of sex chromosome dimorphism in many plants (Divashuk et al., 2014).

Cannabis sativa is a diploid organism ($2n = 2x = 20$) with autosomal nine pairs and XX (♀) or XY (♂) chromosomes (Vyhnánek et al., 2015). Sexual expression in *C. sativa* is determined by heteromorphisms of chromosomes, where individuals XY and XX are, respectively, male and female (Fig. 12.1).

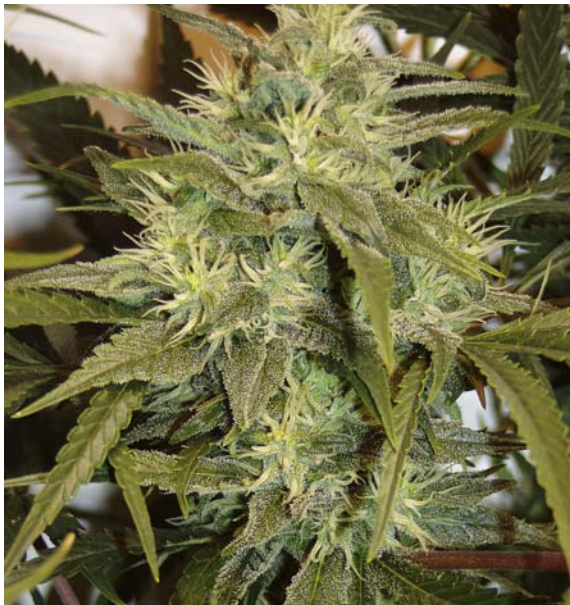

Figure 12.1 Main shoot of not pollinated mature inflorescence in the female dioecious *Cannabis sativa* plant.

Polyploidization can increase the contents of THC, sugars, protein, and flavonoids compared with diploid plants (Bagheri and Mansouri, 2015). Distinguishing male plants from female plants at the vegetative stage is virtually not possible without using molecular techniques (Pollastro et al., 2018). However, flowering male and female plants can be easily recognized by their very different floral structures (Schlutenhofer and Yuan, 2017).

Cannabis sativa is an allogamous species — pollinated by the wind in natural environmental conditions, which favours genetic heterogeneity. Some varieties are monoecious, even though they have an XX chromosomal configuration (Soler et al., 2017).

Because the *C. sativa* female plants usually have a much higher content of cannabinoids than males, production of feminized varieties, where 100% of individuals are female, is a common practice. It is possible thanks to chemical mediation by substance, such as silver thiosulphate (Chandra et al., 2017b; Schlutenhofer and Yuan, 2017), which induces production of fertile male flowers in the body of genetically female plants. These functionally male flowers produce exclusively X gametes resulting, after fertilizing the X female gametes, in feminized (XX) cultivars. This alteration of the reproduction, which allows self-pollinations and crossings between genetically female plants, may increase inbreeding and, therefore, have a considerable impact in the genetic structure of *C. sativa* cultivars (Soler et al., 2017). Also, breeding methods used to develop new cultivars may have a significant effect on the genetic structure of the crops (Hall et al., 2012).

In this respect, the most common methods of developing new *C. sativa* cultivars generally include a selection of individuals within heterogenous cultivars, hybridization of different cultivars, or a combination of both (Chandra et al., 2017b). When the population size used for the development of new cultivars is small, which due to the illegal nature of the crop may be a frequent phenomenon in the development of new *C. sativa* varieties, a genetic bottleneck effect may take place, which reduces diversity and may increase homozygosity due to crossings among related individuals (Soler et al., 2017).

A significant number of plants may show differentiation of the cannabinoid profile and content, even when the material is propagated by single sowing (Pollio, 2016). Male plants produce much smaller amounts of cannabinoids, and pollinated females reverse resources from the production of cannabinoids to develop fruits (Mansouri et al., 2009). To avoid shifting the resources one of the options is to remove the male plants as they appear. Alternatively, male plants presence can be prevented by using vegetative reproduction or micropropagation (Chaohua et al., 2016), ensuring in each case that the reproductive material is female. It is also possible to multiply crops from specially made entirely female fruits (Schafroth and Carreira, 2017).

12.1.2 Biologically active compounds

Cannabis sativa contains numerous biologically active compounds representing different chemical classes. Some of them belong to the primary metabolites, for example, amino acids, fatty acids, and steroids, while cannabinoids (Borille et al., 2017), stenbenoids, flavonoids, lignans, terpenoids and alkaloids are secondary metabolites (Vickery et al., 2016).

The metabolic profile of this plant is vibrant. In total over 500 ingredients were identified (Pollio, 2016).

The coexistence of cannabinoids, flavonoids, and stilbenoids in *C. sativa* links with various PKS enzymes, classified with three types. Among them, chalcone synthase and stilbene synthase are the best-studied enzymes from the PKS type III group, found exclusively in plants and bacteria (Duraisamy et al., 2018; Pollastro et al., 2018; Vickery et al., 2016).

Concentrations of these constituents depend on tissue type, age, cultivars, growth stage (De Backer et al., 2012).

12.1.2.1 Phytocannabinoids

Plant-derived cannabinoids (Fig. 12.2) are terpenophenol compounds with the properties of compounds composed of 21 carbon atoms (C₂₁), and they occur in the plant in the form of carboxylic acids. Cannabinoids are well recognized among *Cannabis sativa* secondary metabolites (Schafroth and Carreira, 2017). Classical phytocannabinoids usually concentrate on a viscous resin produced and sequestered in the structures known as glandular secretory hair follicles – trichomes (Lewis et al., 2018). So far, about 100 phytocannabinoids were recognized in plants (Russo and Marcu, 2017b). Their production increases in plants under stress.

12.1.2.1.1 Characteristics of the most common cannabinoids

In addition to THC, CBD and CBDV, other significant cannabinoids, including THCV and CBG, have the potential to attract some interest. In fresh plant material, all cannabinoids are present in cannabinoid acid forms such as Δ^9 -tetrahydrocannabinol acid – THCA and cannabidiol acid – CBDA (Marcu, 2016). When the plant material ages or

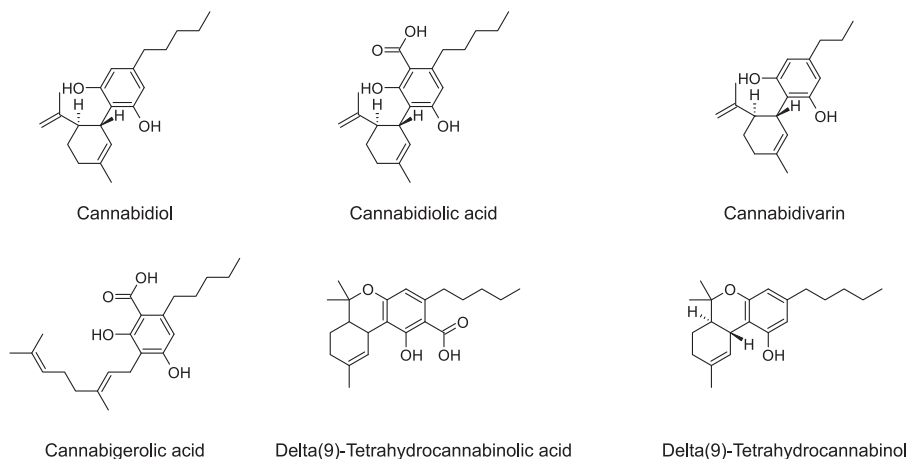

Figure 12.2 Most common phytocannabinoids occurring in *Cannabis sativa* tissues.

is heated, the acid molecules lose the carboxylic moiety. Decarboxylation converts cannabinoid acids into their inactive forms (CBDA to CBD) (Hillig and Mahlberg, 2004). Evidence suggests that these secondary metabolites play a crucial role in the defence of *Cannabis* plants (Pudełko et al., 2014). The species tend to optimize protection by allocating secondary metabolites to tissues in a direct proportion to their value. In *Cannabis*, this tissue is a pistillate inflorescence's densely developed trichome structure (Pollastro et al., 2018).

12.1.2.1.2 Synthesis

At the beginning of the cannabinoid biosynthesis pathway, the first enzyme involved in the process is polyketide type III synthase (PKS III), which requires a combination of olivetolic acid cyclase (OAC) to catalyze the condensation of hexanoyl-CoA with three molecules of malonyl-CoA to obtain olivetolic acid (Gagne et al., 2012). In the next step, the olivetolic acid reacts with geranyl pyrophosphate to form CBGA, which is transformed by oxidocyclase enzymes to significant phytocannabinoids – THCA and CBDA. Decarboxylation of THCA and CBDA occurs without enzymatic activity resulting in the establishment of THC and CBD, respectively (Gagne et al., 2012; Geissler et al., 2018).

12.1.2.2 Terpenes and terpenoids

Terpenes (Fig. 12.3) are small isoprenoid molecules classified as monoterpenes, sesquiterpenes, diterpenes or carotenoids, dependent on the number of isoprene units (C₅) used to synthesize them. Terpenoids are small lipid compounds derived from terpenes, often accompanied by a strong fragrance suitable for protection against possible predators.

12.1.2.2.1 Characteristics of the most common terpenes and terpenoids

Terpenoids not only have essential functions when coupling with cannabinoids as they have been widely studied on many different plant species and are found by medicine for their anti-oxidant, anti-bacterial, anti-fungal, anti-inflammatory, anti-stress, anti-cancer and analgesic properties. However, while gene networks that control the biosynthesis of cannabinoids and their precursors were extensively studied, the biosynthetic pathway of the terpenoid molecules in *Cannabis sativa* was only recently

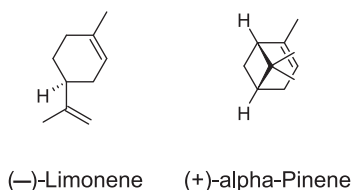

Figure 12.3 Most common monoterpenes occurring in *Cannabis sativa* tissues.

clarified (Pollastro et al., 2018). Only two genes were characterized, one coding (–)-limonene synthase, the other (+)- α -pinene synthase, two enzymes accountable for the conversion of geranyl pyrophosphate to, respectively, limonene and pinene. What is noteworthy, while cannabinoids are mostly found in *Cannabis* plants, terpenoids are also produced by many other plant species, so they must share the same enzymes involved in their metabolism (Massimino, 2017). Transcripts related to the biosynthesis of terpenes are strongly expressed in trichomes as compared to non-resinous tissues (Booth et al., 2017).

12.1.2.3 Flavonoids

Flavonoids are widely occurring chemicals in the plant kingdom and are responsible for many functions in the physiology, ecology, and biochemistry of plants. These constituents occur in tissues of *Cannabis sativa* flowers, leaves, pollen, and twigs. About 20 have been described, representing seven chemical structures that can be prenylated, glycosylated or methylated (Pollastro et al., 2018). For example, cannflavin A and cannflavin B are methylated isoprenoid flavones. Some studies suggest probable modulation through cannabinoids (Flores-Sanchez and Verpoorte, 2008).

12.1.2.3.1 Synthesis

Flavonoid pathway was broadly studied in several plants (Duraisamy et al., 2018). However, data on the flavonoid biosynthesis path in *Cannabis* is not sufficient.

Presumably, precursors in the general pathway of flavone and flavonol (Fig. 12.4) biosynthesis are phenylalanine from the shikimate pathway and malonyl-CoA, obtained due to the carboxylation of acetyl-CoA, the central intermediate in the Krebs tricarboxylic acid cycle. Phenylalanine is then transformed into p-cinnamic acid using phenylalanine ammonia lyase (PAL), which is further hydroxylated by cinnamate-4-hydroxylase (C4H), to p-coumaric acid to 4-coumarate CoA ligase (4CL) attaches ester thiol CoA. One molecule of p-coumaroyl-CoA and three molecules of malonyl-CoA are condensed by chalcone synthase (CHS) – PKS – giving naringenin chalcone. The compound obtained is then isomerized by the enzyme chalcone isomerase (CHI) to the naringenin and flavanone. Naringenin is a common substrate for flavone and flavonol biosynthesis (Behr et al., 2018).

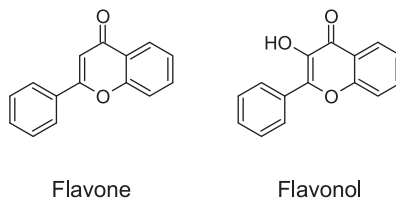

Figure 12.4 Most common flavonoids occurring in *Cannabis sativa* tissues.

12.1.2.4 Stilbenoids

Stilbenoids (Fig. 12.5) are phenolic compounds scattered in *Plantae*. Their functions in plants include constitutive and inducible defence mechanisms, growth inhibition and dormancy signalling. Often, stilbenoids are present in stem, leaves, and resin, and may have an anti-fungal and anti-bacterial activity or are repellent to insects. Nineteen of these substances have been identified in *Cannabis* (Duraisamy et al., 2018).

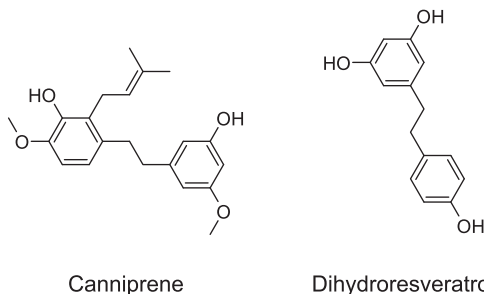

Figure 12.5 Most common stilbenoids occurring in *Cannabis sativa* tissues.

12.1.2.4.1 Synthesis

Possibly, the first step of the biosynthesis process is condensation of one molecule of dihydro-p-coumaroyl-CoA and three molecules of malonyl-CoA to dihydroresveratrol forming bibenzyls. Dihydroresveratrol and canniprene in *Cannabis* are synthesized from dihydro-p-coumaric acid. Similar to flavonoid biosynthesis, methylation and prenylation form the modified bibenzyl compounds (Russo and Marcu, 2017b).

A second step could involve bibenzyls to form 9,10-dihydrophenanthrenes. An intermediate step between bibenzyls and 9,10-dihydrophenanthrenes is possible in the biosynthesis of spirans. However, data about the biosynthesis of spirans or the regulation of the stilbenoid pathway in *Cannabis* is not sufficient.

12.1.2.5 Alkaloids

Another group of secondary metabolites found in plants. Alkaloids – mostly contain elementary nitrogen atoms, and can be derived from amino acids. They usually show biological activity in animals.

About 10 alkaloids were identified in roots, stems, leaves, pollen, and fruits in *Cannabis sativa*. Choline, neurine, L-(+)-isoleucine-betaine – protoalkaloids; hordenine – a phenethylamine being a feeding repellent for grasshoppers and trigonelline – a pyridine. Cannabisativine and anhydrocannabisativine – polyamines derived from spermidine are subclassified as dihydroperiphylline type (Russo and Marcu, 2017b). They are 13-membered cyclic compounds where the polyamine spermidine is attached via its terminal N-atoms to the β -position and the carboxyl carbon of a C₁₄-fatty acid. Piperidine and pyrrolidine were also identified in the plant (Pollastro et al., 2018; Fig. 12.6).

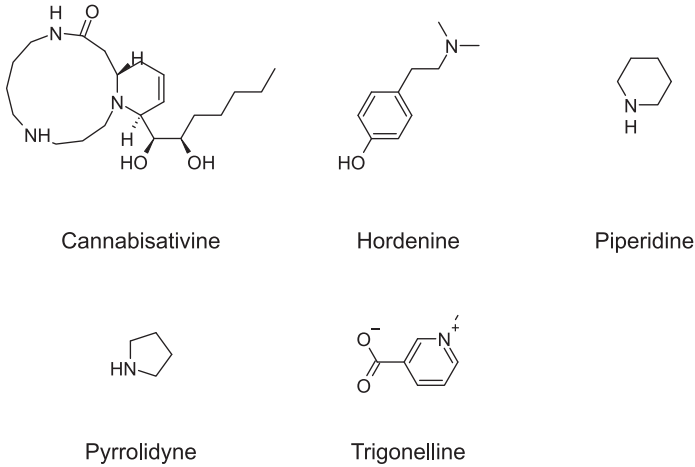

Figure 12.6 Most common alkaloids occurring in *Cannabis sativa* tissues.

12.1.2.5.1 Synthesis

Tyramine is obtained by decarboxylation of tyrosine, which through di-N-methylation produces hordenine (Russo, 2011). Trigonelline found widely in plant species participates in the pyridine nucleotide cycle which supplies the NAD cofactor. Trigonelline is synthesized from the nicotinic acid formed in the pyridine nucleotide cycle. Choline is a noteworthy plant chemical constituent because of being a precursor of the membrane phospholipid – phosphatidylcholine. It is biosynthesized from serine amino acid and ethanolamine.

Piperidine originates from lysine and pyrrolidine from ornithine. The structures of cannabisativine and anhydrocannabisativine are similar to the alkaloids palustrine and palustridine from several *Equisetum* species (Brenneisen, n.d.).

12.1.2.6 Lignanamides and phenolic amides

Cannabis sativa consists of at least 10 constituents identified as phenolic amides and lignanamides (Fig. 12.7). Phenolic amides – N-trans-feruloyltyramine, N-trans-coumaroyltyramine and N-trans-caffeoyltyramine, and lignanamides – cannabisin-A, -B, -C, -D, -E, -F, -G and grossamide. The lignanamides are placed in the *Cannabis* lignan group, and the lignanamides are classified as arylnaphthalene derivative type group (Pollastro et al., 2018).

The incidence and accumulation of phenolic amides in response to wounding and UV light suggest chemical protection against predators. Lignans have insecticide effects, they play a significant role in the flowering process, in resistance to the viruses, suberization, and healing (Behr et al., 2018; Głodowska, 2017).

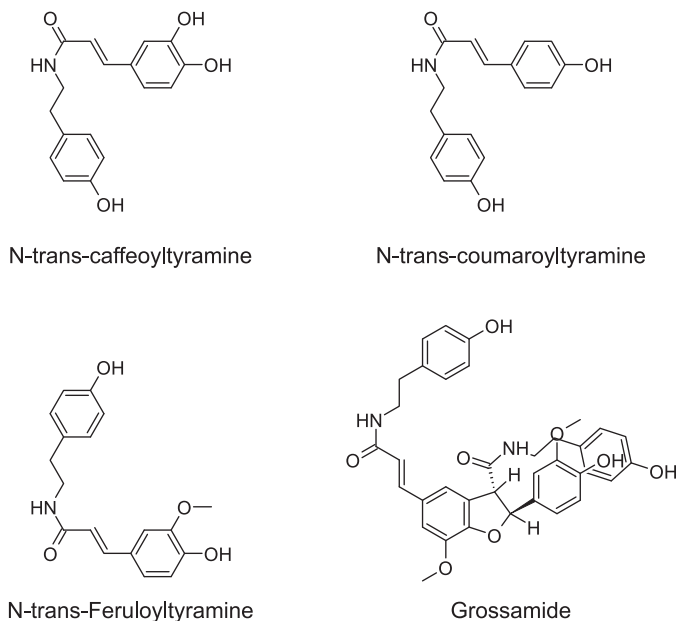

Figure 12.7 Most common phenolic amides and lignanamides occurring in *Cannabis sativa* tissues.

12.1.2.6.1 Synthesis

Lignanamide and phenol amides from *Cannabis* suggest condensation and polymerization in the biosynthesis pathway, starting from tyramine precursors and coumaric, caffeic and coniferic acid CoA esters. The enzyme hydroxycinnamoyl-CoA:tyramine hydroxycinnamoyltransferase (THT) condenses hydroxycinnamoyl-CoA esters and tyramine. Tyramine comes from tyrosine and the phenylpropanoids from phenylalanine. N-transferuloyltyramine and N-trans-caffeoyltyramine may be the monomeric intermediates in the biosynthesis path of these lignanamides (Behr et al., 2018; Pollastro et al., 2018).

12.2 Human and medicine

12.2.1 Endocannabinoid system (ECS)

The endocannabinoid system (ECS) is a biochemical system involved in the regulation of many physiological and cognitive processes. The functions of this system are the regulation of neurotransmission through interaction with presynaptic receptors in the central nervous system, and the control of many physiological processes by direct activation of receptors in tissues and organs. The cognitive processes regulated by this system include memorizing and consolidating short-term memory, motivation and influence on motor activity, feeling hunger and satiety, feeling of pain. The physiological and biochemical processes controlled by this molecular system are metabolism of lipids and carbohydrates, the activity of adipocytes, hepatocytes and the endocrine part of the pancreas, implantation, proper pre- and postnatal

development, as well as functioning of the immune system and the course of the inflammatory reaction process (Di Marzo, 2006; Mechoulam et al., 2014).

12.2.1.1 *Biological significance*

The functions regulated by this system differ in terms of the effects they cause as well as belonging to the systems and organs of the body that are controlled by it. Nevertheless, the characteristic feature of ECS is its occurrence to the greatest extent in the nervous and immunological systems, which leads to the conclusion that ECS is involved in the regulation of processes occurring mainly in these systems (Di Marzo, 2006; Mechoulam et al., 2014).

12.2.1.2 *ECS components*

Three types of components can distinguish the endocannabinoid system:

- I. Cannabinoid receptors
- II. Endogenous cannabinoids
- III. Enzymes regulating the biosynthesis and biodegradation of endogenous cannabinoids

Cannabinoid receptors (CBRs) belong to the group of G protein-coupled receptors (GPCR), thus have the structure of an alpha-helical polypeptide consisting of seven domains passing through the cell membrane, connected to the G_i protein on the inside of the membrane. A G_i protein, when activated, inhibits the enzyme adenylate cyclase. It is the α -subunit that interferes with adenylate cyclase. The by-dimer can regulate other enzymes such as mitogen-activated protein kinase (MAPK) and phosphatidylinositol-3-kinase (PI3K) or directly modify the activity of ion channels. Adenylate cyclase in turn no longer breaks ATP to form the second messenger – cAMP. It plays major roles inside a cell: through protein kinase A it can phosphorylate some proteins (such as transcription factors), and phosphorylation of proteins changes their activity. Also, cAMP binds to and regulates the function of ion channels. Rapid effect of CBR stimulation seems to be mediated through a decreased phosphorylation of A-type potassium channels, resulting in their opening. When a potassium channel opens, the net force (electrical and concentration gradient) results in an efflux of potassium, and the loss of positive charges from the cell renders the cell less excitable (hyperpolarized) (Raymon and Walls, 2007). For this reason, CBRs are classified as inhibitory receptors. At the cellular level, the CB₁ receptors are located predominantly on presynaptic terminals of gamma-aminobutyric acid (GABA) and glutamate neurons. The result of cannabinoid receptor stimulation is, therefore, inhibition of release of those neurotransmitters to the synapsis (Schlicker and Kathmann, 2001).

12.2.1.2.1 CB₁, CB₂ receptors

As previously mentioned, two types of cannabinoid receptors have been distinguished: CB₁ and CB₂. The difference between them lies in the amino acid composition of the transmembrane peptide and locations of expression in the body. Homology of human CBR types is about 44% (Munro et al., 1993).

The CB₁ receptor is the most widely distributed G-protein-coupled receptor in the CNS. This type of receptor occurs mostly in specific regions of the brain: the cerebral cortex, particularly the association and motor cortex, cerebellum, basal nuclei and in

the limbic forebrain (particularly the hypothalamus, hippocampus, and anterior cingulate cortex). The presence of CB₁ receptors in these regions is expected given the many significant effects related to cognition, motivation, movement coordination and maintaining of homeostasis. Whereas the basal ganglia allow the initiation of movement, the cerebellum controls the ongoing aspects of it (Raymon and Walls, 2007). The hippocampus stores memory and codes sensory information. The presence of cannabinoid receptors in regions associated with mediating brain reward (ventromedial striatum and nucleus accumbens) is consistent with the role that cannabinoids play in the neurobiology of reward (Martin and ElSohly, 2007). It is certain that through the hypothalamic CB₁ receptors of the endogenous cannabinoid system plays a role in appetite and regulates food intake.

Furthermore, it is also engaged in body temperature homeostasis (Wenger and Moldrich, 2002). Besides, CBRs are expressed in the spinal cord (where they play a role in the modulation of pain signalling) (Starowicz and Finn, 2017), peripherally in sensory neurons and the autonomic nervous system — what depends on modulation of numerous peripheral effects, such as vasodilatation and tachycardia (Pacher et al., 2005). In addition to the nervous system, weak expression occurs in the liver, spleen, adipose tissue, eye, testes, uterus, and even cells of the embryo (Pagotto et al., 2006). This signalling is essential in regulating the timing of embryonic implantation and uterine receptivity (Fride, 2004). These complex interactions explain not only a large number of physiological actions of cannabinoids but also the pharmacological effects of cannabis preparations.

CB₂ receptors, in contrast to CB₁ receptors they are not coupled to ion channels. The occurrence of CB₂ receptors are mainly limited to cells of the immune system, and their highest number occurs on mature B lymphocytes and macrophages, in smaller amounts on mast cells, NK cells, CD4⁺, and CD8⁺ lymphocytes (Pertwee, 2005). Their presence was found in the tissues of the brain, lymph nodes, spleen, thymus and tonsils, and in particular in microglial cells (where they occur together with CB₁ receptors) (Martin and ElSohly, 2007). This receptor has been accounted for a variety of modulatory functions, including regulating cell migration, phagocytosis, but mostly — suppression of immune cells (Turcotte et al., 2016, p. 2). The immunosuppressive activity is caused by downregulation of pro-inflammatory cytokines release (e.g., TNF- α , IL-1 β , IL-1Ra), inhibition of cyclooxygenase-2 (COX-2) synthesis and CD40 expression (Cassano et al., 2017). Those mechanisms result in a suppressed proliferation of B and T cells in response to cell-specific mitogens, inhibition of cell-killing activity, proliferation and maturation of T_c lymphocytes and NK cells (Cabral and Griffin-Thomas, 2009). Overall, the stimulation of CB₂ receptors induces anti-inflammatory effect and may lead to autoimmunological diseases treatment.

CBRs ligands is a group of compounds called cannabinoids. We divide it into:

- I. Endocannabinoids
- II. Synthetic cannabinoids
- III. Phytocannabinoids

12.2.1.2.2 Endogenous cannabinoids

The first group, derivatives of arachidonic acid — endogenous cannabinoids — are chemical compounds synthesized in animal organisms. The highest ratio is provided

by two compounds – N-arachidoneethanolamine or anandamide (AEA) and 2-arachidonoylglycerol (2-AG). AEA is a partial agonist of CB₁ receptors and a weak agonist of CB₂ receptors, where 2-AG exhibits the activity of a full CB₁ receptor agonist. There are also other compounds included in this group, but their role in the functioning of the system seems to be less critical. These include the noladine ether (ether derivative 2-AG), virodamin, N-arachidonoyl dopamine and palmitoylethanolamide (Pertwee, 2005).

12.2.1.2.3 Enzymes regulating the biosynthesis and biodegradation of endogenous cannabinoids

Enzymes involved in the biosynthesis of endocannabinoids include phospholipases A1, A2, C and D, N-acyltransferase, diacylglycerol lipase, and anandamide-specific enzyme N-acyl phosphatidylethanolamine phospholipase D (NAPE-PLD). The biodegradation of anandamide to arachidonic acid and ethanolamine corresponds to fatty acid amide hydrolase (FAAH), whereas in the case of 2-AG – monoacylglycerol lipase (MAGL) and causes the disintegration of the molecule to arachidonic acid and glycerol (Di Marzo et al., 1998; Mechoulam et al., 2014).

12.2.1.3 Synthetic cannabinoids

The second, notable group of cannabinoids are synthetic ligands of cannabinoid receptors with different chemical structure, different selectivity and affinity for CBRs. Their pharmacodynamics are based mainly on the stimulation or inhibition of CB receptors exclusively – with less significant participating in other receptor mechanisms (Khan et al., 2016).

12.2.1.4 Phytocannabinoids

The third group – phytocannabinoids characterized by an affinity for cannabinoid receptors, although this is not always the case for all compounds (for example, cannabidiol, which content in plant tissue is relatively the highest of all cannabinoids, practically has no affinity for CBRs) (Izzo et al., 2012). Phytocannabinoids are responsible for the therapeutic and medical effect of cannabis preparations. Individual products provide a mixture of cannabinoids, as it is challenging to form preparations with a single compound isolated. Products existing on the market that are not a mixture of various compounds are mainly preparations with isolated Δ^9 -THC, CBD, and CBD-A (commonly available in the form of oil solutions). In addition to these examples, the vast majority of the medicinal uses of cannabinoids is associated with the adoption of a whole range of compounds of known pharmacodynamics but unknown proportions, depending on the variety and cultivar of the plant from which the raw material was made (Mechoulam, 2005).

12.2.2 Psychogenic side effects of cannabinoids – physiological elucidation

Psychoactive effect of *Cannabis* is desired in recreational use and is unsought in medical treatment. It is characterized by a general alteration of conscious perception, euphoria, feelings of well-being, relaxation or stress reduction, increased appreciation of the arts, including humour and music, joviality, metacognition and introspection,

enhanced recollection (episodic memory), increased sensuality, increased awareness of sensation, increased libido and creativity (Earleywine, 2002). Very few cannabinoids show psychoactive effects. In order for a given substance from the cannabinoid group to have a psychoactive effect, it must jointly meet two conditions:

- be a potent agonist of CB₁ receptors
- can cross the blood-brain barrier

These criteria are met by (–)-trans- Δ^9 -tetrahydrocannabinol (Δ^9 -THC) and its geometrical isomers and enantiomers. Both the plant precursor for THC synthesis – cannabigerol acid, as well as its intermediate metabolite – tetrahydrocannabinol acid (THC-A) do not have psychoactive properties (Izzo et al., 2009). Only plants containing more than 1% THC can induce intoxication (Earleywine, 2002).

The most feasible way to deliver THC is to smoke the plant material, which provides a quick and effective method of delivering the drug from the lungs to the brain, but also contributing to the increased likelihood of abuse. One study found that the highest plasma THC levels occur after about 10 min, after which they are about 60% and 20% of concentrations, respectively, 15 and 30 min after smoking. The THC concentration in the plasma was approximately 5% of the peak after 2 h. The other way to take THC is oral administration, but the absorption is lower than through smoking. It has been shown that the availability of oral administered THC varies from 6% to 20%, and the maximum concentration occurs from 1 to 6 h from the time of admission. The first phase of THC metabolism in an organism is oxidation. THC is initially metabolized to 11-hydroxy-THC, 8- β -hydroxy-THC and with smaller efficiency to 8- α -hydroxy-THC, 8- β -11-dihydroxy-THC, and other minor metabolites. Microsomal cytochromes P450 2C9, 2C19, and 3A4 are involved in the oxidation of THC. Those metabolites are still psychoactive, and 11-OH-THC is further oxidized to non-psychoactive 11-Nor-9-carboxy- Δ^9 -tetrahydrocannabinol (THC-COOH). This compound can be glucuronidated in the second phase of metabolism and is mainly excreted into urine. In human, more than 100 metabolites could be identified, but 11-OH-THC and THC-COOH are the dominating metabolites. Within 5 days, a total of 80%–90% of a THC dose is excreted, mostly as hydroxylated and carboxylated forms. More than 65% is excreted in the feces, with approximately 20% eliminated in the urine. Numerous acidic metabolites are found in the urine, many of which are conjugated with glucuronic acid to increase their water solubility. The primary urinary metabolite is the acid-linked THC-COOH glucuronide conjugate, while 11-OH-THC predominates in the feces (Grotenhermen, 2006; Huestis, 2005; Huestis and Smith, 2007). The other routes of administration are rectal, and dermal administration (practically rarely used in treatment) and sublingual – a Sativex.

12.2.3 Pharmacodynamics of particular phytocannabinoids (affinity for CBR and other receptors) and the biological effects

12.2.3.1 THC – tetrahydrocannabinol

Δ^9 -THC is a partial agonist of CB₁ and CB₂ receptors. The presence of CB₁ receptors in brain regions such as the association and motor cortex, cerebellum, basal nuclei, and

the limbic forebrain is responsible for essential effects related to cognition, motivation, movement coordination, and appetite. As it was described, agonizing of CB₁ receptors results in decrease release of GABA and glutamate (which are postsynaptic neuromediators) what affects various psychic processes related to those regions of the brain (Raymon and Walls, 2007). This phenomenon is responsible for infamous psychoactive effects caused by *Cannabis* products, which however are desirable in treatment, or relieving the symptoms of psychiatric diseases, including schizophrenia, neurosis, insomnia (Fichtner and Moss, 2017). Stimulation of CB₁, as expressed of food intake controlling regions of the hypothalamus, is successfully used in order to stimulate the appetite of patients during anti-tumour chemotherapy or suffering from AIDS (Grotenhermen and Müller-Vahl, 2012).

Regarding anti-convulsive properties: the agonistic activity of CB₁, via cAMP synthesis inhibition, induces potassium efflux by stimulating A type and G-protein coupled inward rectifying potassium channels; also, it decreases calcium influx by inhibiting voltage-dependent N and P/Q-type calcium channels. This diminishes neuronal hyperexcitability and may attenuate seizure frequency. It also ameliorates the spasticity and tremors of multiple sclerosis and Huntington's disease (Kolikonda et al., 2015). A less significant but important mechanism which is synergistic to CBR related transmission is agonizing of G protein-coupled receptors 55 and 18 (GPR55, GPR18). Antagonizing of serotonin 5-HT_{3a} receptor leads to potent anti-emetic effect, commonly used in order to alleviate chemo- or radiotherapy-induced vomiting. Activation of peroxisome proliferator-activated receptors gamma (PPAR γ) and transient receptor potential cation channel, subfamily A (TRPA1) and V (TRPV2, 3 and 4) seem to be linked to vascular relaxation and anti-tumour effects. Δ^9 -THC is also a positive allosteric modulator of the μ - and δ -opioid receptors as well as glycine receptors with affinity to α 1 and α 3 subunits. This activity seems to contribute to the cannabis-induced analgesia (Grotenhermen and Müller-Vahl, 2012; Morales et al., 2017). CB₂ related are anti-inflammatory activities may be used in autoimmune disorders treatment, such as such as rheumatoid arthritis, atherosclerosis, and inflammatory bowel disease (Turcotte et al., 2016).

In addition to this compound, the group of phytocannabinoids includes 65 others (Brenneisen, n.d.). However, some studies say that 113 phytocannabinoids have been identified (Aizpurua-Olaizola et al., 2016). What is essential – these compounds do not show, or show a slight psychoactive effect as they weakly stimulate the CB₁ receptors. These are:

12.2.3.2 CBD – cannabidiol

Dependent on the variety – the first or the second most abundant phytocannabinoid occurring in the *Cannabis sativa* tissues. CBD lacks affinity to CB receptors (McPartland et al., 2009). However, some claim that it acts as CB₁ and CB₂ antagonist (Thomas et al., 2009) and it does not show psychoactive properties, although it strengthens the effect of THC. This mechanism can be elucidated by inhibition of hepatic drug metabolism. Pre-treatment of mice with high doses of cannabidiol results in an increase in THC level in the brain, but even a high dose of orally applied pure CBD do not cause THC-like effects in humans (Grotenhermen et al., 2017). This pharmacokinetic interaction between THC and CBD could be described by the increased effects of THC by CBD pretreatment. However, CBD cannot change THC blood level

with co-administration of both compounds (Zuardi, 2008). A wide range of CBD's pharmacological actions goes along with high therapeutic interest. Although it exhibits very weak affinity to CB receptors, determined CBD molecular mechanism are (Izzo et al., 2009; Morales et al., 2017; Pertwee, 2005):

- GPR55 antagonizing,
- FAAH inhibition,
- anandamide reuptake inhibition,
- positive allosteric modulation at $\alpha 1$ and $\alpha 1\beta$ glycine receptors,
- positive allosteric modulator at μ - and δ -opioid receptors,
- agonizing of transient receptor potential cation channels: TRPA1, TRPV1, and TRPV2,
- antagonizing of TRPM8,
- adenosine uptake competitive inhibition,
- PPAR γ agonizing,
- serotonin receptor 5-HT $_{1A}$ agonizing,
- regulation of intracellular Ca $^{2+}$,
- T-type Ca $^{2+}$ channel inhibition,
- suppressing of tryptophan degradation,
- 5-lipoxygenase and 15-lipoxygenase inhibition,
- phospholipase A2 modulation,
- anti-oxidant.

Numerous molecular routes of action suggest the anxiolytic, anti-psychotic and sedative actions that may potentially be used in psychiatric disorders and diseases. Clinical studies show that CBD is a practical, safe and well-tolerated alternative treatment for schizophrenic patients. It may have positive effects on patients who have dystonia in Huntington's disease. Anti-oxidative and neuroprotective effects are considered to apply to Parkinson's and Alzheimer's diseases (Zuardi, 2008). Research on anti-inflammatory properties of CBD presents it as a potential therapeutic agent in rheumatoid arthritis. Anti-oxidative and anti-inflammatory effect of CBD has led to the research indicating its possible activity in preventing damage caused by cerebral and heart ischemia (Pisanti et al., 2017; Zuardi, 2008). It shows efficacy in treating drug-resistant epilepsies, such as Dravet syndrome, Lennox-Gastaut syndrome and Doose syndrome (Ekstein, 2015). According to data published in New England Journal of Medicine, among child patients suffering from Dravet syndrome and treated with CBD, the number of seizures per month decreased double, and 5% of patients became seizure-free (Devinsky et al., 2017). This fact influenced an increase in the use of CBD-enriched extracts as a potential remedy for epilepsy, particularly in children (Perucca, 2017). Unlike THC, the anti-convulsant properties result from the existence of mechanisms independent of cannabinoid receptors. Some recent studies show CBD as a promising future avenue of investigation in research concerning neuro-inflammation related to brain injuries (Schurman and Aron, 2017). CBD is also considered as an anti-cancer drug (Alexander et al., 2009; Hermanson and Marnett, 2011; Kapoor, 2013; Ligresti, 2006). However, the precise mechanisms underlying CBD's effects on apoptosis and tumor growth are not precise.

12.2.3.3 CBN – cannabinol

CBN is a non-enzymatic product of THC oxidation, more common in older cannabis samples. It functions as a weak partial agonist of the CB $_1$ and CB $_2$ receptors with

higher affinity for the CB₂ (Pertwee, 2008). Although its psychoactive properties are weak, intravenous injection of high dose CBN may induce slight subjective feeling (Earleywine, 2002). It is an agonist of TRPV2 – a high-threshold thermo-TRP channel, as it activates at temperatures well beyond the noxious threshold (over 52 °C) which possibly can be useful in treating burns (Russo and Marcu, 2017a). It inhibits keratinocyte proliferation, regardless of cannabinoid receptor activity (Wilkinson and Williamson, 2007). CBN inhibits breast cancer resistance protein, however only when applied in high concentration (Holland et al., 2009), and stimulates the employment of marrow's quiescent mesenchymal stem cells, which suggests promotion of bone formation (Scutt and Williamson, 2007). It has also confirmed anti-convulsant and anti-inflammatory properties (McPartland and Russo, 2006).

12.2.3.4 CBG – cannabigerol

CBG is a weak partial agonist of CB₁ and CB₂ receptors (with a slightly stronger affinity for CBR₂) and anandamide reuptake inhibitor in the low micromolar range. Other pathways are TRPV1 and TRPA1 agonizing and TRPM8 antagonizing, which plays a potential role in analgesia. There is evidence that cannabigerol is a highly potent α_2 -adrenoceptor agonist and moderately potent 5-HT_{1A} receptor antagonist (Cascio et al., 2010). Earlier work supports gamma-aminobutyric acid (GABA) uptake inhibition greater than THC or CBD that could suggest muscle relaxant properties (Banerjee et al., 1975). Later on, it was proven to be cytotoxic in high dosage on human epithelioid carcinoma (Baek et al., 1998), and after CBD is the next most effective phytocannabinoid against breast cancer (Ligresti, 2006). It was also proven to have anti-proliferative properties with potential utility in psoriasis (Wilkinson and Williamson, 2007) and it exerts potent neuroprotective activity, with potential use against neurodegeneration, where neuroinflammation and oxidative stress play role (Gugliandolo et al., 2018).

12.2.3.5 CBDV – cannabidivarin

Its pharmacodynamics has not been yet thoroughly examined, it has a very weak affinity to both types of CB receptors, although it has been reported that CBDV acts via CB₂ cannabinoid receptor-dependent mechanisms, but direct CB₂ receptor effects were not shown (Scutt and Williamson, 2007). Pure CBDV inhibits diacylglycerol lipase-a (however at high molar concentration) and might decrease the activity of its product – the endocannabinoid, 2-AG (De Petrocellis et al., 2011). CBDV is as a potent anti-convulsant in a range of in vivo seizure models comparable to phenobarbitone and felbamate that parallel a variety of human seizure types and pathologies (Hill et al., 2012). However, more efforts are required to determine the anti-convulsant molecular mechanism. It is actively developed by GW pharmaceuticals regarding epilepsy and autism spectrum disorders.

12.2.3.6 CBC – cannabichromene

Like CBDV, it has a minimal effect on the CB₁ and CB₂ receptors. It stimulates TRPV1 and is the most potent agonist of TRPA1 among phytocannabinoids; it also

acts as a strong anandamide reuptake inhibitor (Izzo et al., 2009; Morales et al., 2017). CBC has anti-inflammatory effects. It has been found to have similar efficacy to phenylbutazone (PBZ) at equivalent doses, but since CBC is less toxic than PBZ, it has been found that higher CBC doses can be used to achieve a more significant therapeutic effect (Wirth et al., 1980). Antibiotic, antiviral and antifungal activities have also been proven (Russo, 2011). It is supposed, that CBC may contribute to the overall analgesic effects of medical cannabis (Maione et al., 2011).

12.2.3.7 *THCV – tetrahydrocannabivarin*

Pharmacology of this compound is considerably different from other cannabinoids, as it acts as CB₁ receptor antagonist and CB₂ receptor partial agonist (Izzo et al., 2009, p.), however, it may act as CB₁ agonist in higher doses (Morales et al., 2017). Due to CBR₁-antagonizing properties, THCV produces weight loss, decreased body fat and serum leptin concentrations with increased energy expenditure in obese mice; that is why it can be considered as a new potential treatment against obesity-associated glucose intolerance (Wargent et al., 2013). THCV also demonstrated a CBR₂-based ability to suppress carrageenan-induced hyperalgesia and inflammation in mice (Bolognini et al., 2010). Beyond the endocannabinoid system, THCV has been reported to activate 5-HT_{1A} receptors and produce anti-psychotic effects (Cascio et al., 2015).

12.2.3.8 *Other phytocannabinoids*

Despite their lower concentration levels in the plant, other phytocannabinoids such as cannabiodiol (CBND), cannabielsion (CBE), cannabicyclol (CBL), and cannabitrilol (CBT) have also been the subjects of pharmacological study over the last few decades, nevertheless further investigation regarding the potential applicability of these compounds is needed (Morales et al., 2017).

12.2.3.9 *Acid forms*

Each cannabinoid described above occurs in plant tissue mainly in the form of carboxyl acid. Cannabinoid acids are found in variable quantities in fresh, undried cannabis, but being progressively decarboxylated with drying, and especially under intense heating. Their pharmacology is different from non-acid derivatives and characterized by lack of CB receptors affinity. None of them, including Δ^9 -THC-A, can result in psychoactive effects. Also, interaction with other molecular pathways seems to be limited (Burstein, 1999).

Regarding THC and CBD, proved pharmacodynamical actions of their acid precursors' are TRPA1 partial agonizing and TRPM8 antagonizing (CBD-A and THC-A), what plays a potential role in analgesia and COX-2 inhibition (CBD-A) providing anti-inflammatory activities (Izzo et al., 2009). However, acid cannabinoids exhibit strong antibiotic properties. They were used for some time in veterinary medicine in Czechoslovakia about 50 years ago (Mechoulam, 2005). There are some old date reports concerning usage of cannabinol acids as topical applied antibiotics.

More current research has revealed that the acids possess both analgesic and anti-inflammatory properties (by inhibition of COX-2 and 5-LOX) and may contribute to the actions of the parent drug (Burstein, 1999). THC-A and CBG-A have also proven to be insecticidal, which explains why the cannabinoid acids are shifted in female inflorescence to trichome glands (Sirikantaramas et al., 2005).

12.2.3.10 Terpenoids and flavonoids

Characteristic, in most cases — the pungent fragrance of cannabis preparations should not be identified with cannabinoids, as it is a result of over 100 terpenoid compounds. Terpenoids are lipophilic, interact with cell membranes, neuronal and muscle ion channels, neurotransmitter receptors, G-protein coupled (odorant) receptors, second messenger systems and enzymes (Russo, 2011). Many healthful properties of terpenoids have been found. Cannabis terpenoids may increase cerebral blood flow, enhance cortical activity, kill respiratory pathogens, and provide anti-inflammatory activity. Mice exposed to terpenoids inhaled from ambient air for 1 h demonstrated significant effects on activity levels, suggesting a direct pharmacological influence on the brain, even at low serum concentrations. Ingestion and percutaneous absorption are also documented in humans (Jager et al., 1992).

Similarly, this data would support a demonstrable clinical role for cannabis terpenoids (Gardner, 2011). Considering terpenoids separately — limonene, for example, has been shown to decrease anxiety in mice via the 5-HT_{1A} serotonin receptors. If inhaled, it has an immune stimulating effect. In laboratory experiments, it influenced the dying of acne bacteria and cancer cells. It also has the potential to treat gastroesophageal reflux. α -pinene is a bronchodilator. It also has antibacterial and antibiotic properties. α -Pinene inhibits decomposition of the acetylcholine, a neurotransmitter involved in memory. β -myrcene, in addition to its anti-inflammatory effect, acts as a muscle relaxant in mice, and potentiate barbiturate sleep time at high doses. Linalool affects serotonin neurotransmission and counters anxiety, it has sedative and anti-convulsant properties; β -caryophyllene is anti-inflammatory and unlike other anti-inflammatories, does not irritate the stomach lining. It was showed that β -caryophyllene activates the CB₂ receptor, making it ‘the first proven phytocannabinoid beyond the cannabis genus’. Other terpenoids with therapeutic potential are nerolidol (it may have sedative and anti-fungal effects); caryophyllene oxide (anti-fungal properties) and phytol (prevents vitamin A teratogenesis) (Brenneisen, n.d.; Russo, 2011).

Flavonoid components of cannabis, especially likely to be of benefit in oral or sublingual administration, include apigenin, a unique agent that has strong anti-anxiety effects without sedation (Salgueiro et al., 1997). Another flavonoid — cannflavin A, work as an anti-inflammatory 30 fold stronger than aspirin (McPartland and Russo, 2006). Another flavonoid — orientin is an anti-inflammatory phytochemical associated with *Cannabis* plant, which contributes to its anti-rheumatic properties (Zaka et al., 2017).

The biological activity of cannabis is not only limited to THC action. It consists of all pharmacologically active components’ synergy in triggering specific physiological action. The clinical contribution of cannabinoids, terpenoids, and flavonoids to clinical cannabis effects has been espoused as an ‘entourage effect’ (Gardner, 2011;

Massimino, 2017). Terpenes may influence changes in THC pharmacokinetics because they cause a significant increase in blood-brain barrier permeability (Russo, 2016). They modulate the affinity of THC for their receptor, by sequestering THC, by increasing the fluidity of neuronal membranes or by interfering with the annular lipids surrounding the receptor (McPartland and Russo, 2006; Russo, 2011). They may influence on the reduction of THC-induced anxiety, cholinergic deficits, and immunosuppression (Russo and McPartland, 2003).

In conclusion, thanks to the knowledge about the health benefits of cannabis and cannabinoids, their uses can be stated as an anti-inflammatory agent, painkiller, nervous tissue protective and regenerating agent, anti-convulsant, anti-spasmodic, anti-nausea and anti-emetic agent, appetite stimulant, anti-depressant, anxiolytic and anti-psychotic, immunological regulator, and antioxidant.

12.2.4 The beneficial effect of phytocannabinoids, terpenoids, and flavonoids on the human body and the physiological explanation of the phenomenon

The term ‘medical cannabis’ refers to plant materials and pharmaceutical products derived from *Cannabis sativa*, which are used for medical prescriptions. Cannabis is used for medicinal purposes from 2700 B.C. (Reekie et al., 2017). The first scientific research by the Irish physician O’Shaughnessy from 1839 was to administer *Cannabis* to patients suffering from numerous diseases (Zaami et al., 2018). As is known, phytocannabinoids are responsible for the treatment and elimination of symptoms of diseases challenging to treat, as well as a positive effect on many physiological processes, which under the influence of association with an illegal drug cause conflicting emotions (Ben Amar, 2006).

12.2.5 Reports on the effectiveness of medical treatment, description of medical cases

Scientific evidence regarding the effectiveness in the cannabis-based treatment of various diseases, as well as many patients’ opinions who use cannabis to relief or eliminate their symptoms exist. These are

- epilepsy
- Parkinson’s disease
- Alzheimer’s disease
- multiple sclerosis
- spasticity
- Tourette’s syndrome
- autism
- Crohn’s disease and other intestine inflammatory conditions
- nausea and vomiting
- loss of appetite and cachexia
- psoriasis
- post-traumatic stress disorder

- neurosis
- psychosis
- insomnia
- chronic pain: neuropathic, metastatic, inflammatory
- migraine
- fibromyalgia
- rheumatoid polyarthritis
- inflammatory bowel disease
- atherosclerosis
- diabetes type II
- osteoporosis
- side effects linked with chemotherapy and radiotherapy
- Hashimoto thyroiditis
- terminal stages of cancer
- open angle glaucoma
- cancer

Evidence for improving the condition of patients with cancer exists; however, cannabis preparations are used most often to relieve the adverse symptoms of chemo- and radiotherapy, as well as cancer pain. There are also reports noting tumour regression due to the use of cannabis (Alexander et al., 2009; Ben Amar, 2006; Javid et al., 2016; Kapoor, 2013; Khan et al., 2016; Nikan et al., 2016; Ramer et al., 2014; Romano et al., 2014; Takeda et al., 2012; Wilkinson and Williamson, 2007). Various studies reported a cannabinoid-induced autophagy mechanism in cancer cells (Costa et al., 2016). In addition to the anatomical locations of cannabinoid receptors described earlier, overexpression of these receptors at the cells of many types of cancer seems extremely interesting. This allocation applies both to the CB₁ receptors associated with the nervous system and to the CB₂ receptors characteristic for cells and organs of the immune system. High expression of these receptors also occurs in tumours not derived from tissues rich in these receptors. They were found to be overexpressed in lung cancer, breast cancer, skin cancer, and prostate cancer, both in primary tumours and metastases (Pisanti et al., 2013; Pyszniak et al., 2016; Velasco et al., 2016).

12.2.6 Pharmacologically active Cannabis sativa preparations

12.2.6.1 Available preparations and use

There are few registered drugs based on cannabinoids. This not very extensive group can be divided into:

- medicaments containing marijuana
- medicaments containing plant cannabinoids extracts (nabiximols)
- medicaments containing synthetic cannabinoids

Medicines from the first group contain dried, blossoming tops of female plants. The Bedrocan company produces medical marijuana for the Dutch Ministry of Health and exports its products to Canada and a few European countries. The products differ in their concentration of THC, CBD and their quantitative relation: Bedrocan® (22%

THC, <1% CBD), Bedrobinol® (13.5% THC, <1% CBD), Bediol® (6.3% THC, 8% CBD), Bedica® (14% THC, <1% CBD and high amount of b-myrcene), Bedrolite® (<1% THC, 9% CBD). The preparations, before being released into the market, are validated about the content of pesticides, heavy metals, and pathogenic micro-organisms.

The second group includes medicines based on the *Cannabis sativa* extract. The U.S. Adopted Name (USAN) and WHO International Nonproprietary Names have suggested the use of the nabiximols definition for cannabis medical extracts. GW Pharmaceuticals, a company with a leading position in the world in the development of cannabinoid plant derivatives, is known for its product — Sativex®, which is intended for use on the oral mucosa, containing *Cannabis sativa* plant extract, containing THC and CBD in a 1:1 ratio, as well as other cannabinoids and non-cannabinoid biologically active ingredients. Each dose is delivering 2.7 mg THC and 2.5 mg CBD. To treat pain associated with multiple sclerosis (MS) the drug was first approved in Canada. Two years later it was approved in the treatment of pain associated with malignant carcinoma. Then, the United Kingdom was registered with an indication of spasticity associated with MS. Currently, Sativex® has been approved for marketing in 21 European countries for the treatment of muscle stiffness and spasm caused by multiple sclerosis, making it the most popular and most desirable cannabis-based drug in Europe. The same company is a producer of Epidiolex®, an oral solution of plant-based CBD at a dose of 25 and 100 mg·mL⁻¹. It is the only medicine containing natural cannabinoids approved by the FDA. It was documented with the status of ‘orphan medicine’ in the treatment of two childhood epilepsy: Dravet syndrome and Lennox and Gastaut syndrome in patients aged 2 years or older. Target indications also include tuberous sclerosis syndrome manifested by epileptic seizures.

Established in 2006 Dutch company Echo Pharmaceuticals has started the production of an oral tablet that contains pure, extracted from *Cannabis* natural Δ^9 -THC. This drug is set to be registered for some indications, including MS, behavioural disturbances in patients with Alzheimer’s disease and chronic pain. Namisol® is now in Phase II of clinical development.

The last group consists of preparations with synthetic THC analogs. Marinol®, which has form capsules for oral administration, contains the corresponding THC analogue, with the pharmacological name — dronabinol. US Food and Drug Administration (FDA), suggested indications for its use are anorexia associated with weight loss in AIDS patients and nausea/vomiting associated with cancer chemotherapy in patients who have not responded appropriately to conventional anti-emetics. Cesamet® in the form of capsules containing nabilone, which is an analogue of THC with slight differences in its molecular structure. This product aimed to find a substance with actions similar to THC, but with limited psychogenic properties, but failed in latter. As with Marinol®, the FDA indicated Cesamet® for symptoms associated with vomiting/nausea in chemotherapy patients. In other countries, including Canada, it is widely used as a supportive therapy for the treatment of chronic neuropathic pain. Currently, there are also synthetic pro-drugs of THC in the pre-clinical phase, developing by Nemus Bioscience. Their compound named NB1111 will be possibly intended for the treatment of glaucoma in the form of eye drops (McCoy, 2017).

12.2.6.2 Legal issues

Widespread use of medicinal cannabis products is limited by one significant fact — the psychoactive effect, which is almost exclusively attributable to THC. The question arises whether advantages of medical use of cannabinoids outweigh drawbacks — their psychoactive properties, the potential risk of addiction and clinical adverse reaction.

Side effects may occur only in case of usage of a preparation containing psychoactive component — THC. Therefore they may be compared to those caused by marijuana. The psychoactive effect, desired in recreational use, is rather unsought in medical treatment. However, the merits of changing the mood of patients suffering from, i.e., a terminal stage of tumor or AIDS is a subjective matter. More significant consequences may be caused by long term usage of THC containing products. Potentially the most substantial issue that instinctively comes to mind is addictive potential. There is a relatively old publication claiming, that each one person per 10 people that have ever tried marijuana, will become addicted. Nevertheless, the same issue maintains, that one per seven will be addicted to alcohol, one per five to cocaine, one per four to heroin and one per 3 to nicotine (Strike et al., 2003).

In conclusion, cannabinoids, besides the fact of psychoactive properties of THC and potential side effects resulting from regular usage, exhibit numerous health benefits. Their pharmacological action, especially regarding the most abundant compounds, has been precisely examined. Therapeutic potential regarding different diseases has been proven on numerous in vitro, animal and human studies, which are translational health research, essential to ensure that biomedical research provides practical benefits.

12.3 Conclusions and prospects

A review of the scientific literature on medical preparations derived from *Cannabis* results in considerable and reliable evidence that marijuana and cannabinoids have therapeutic properties and potential to cure a multitude of diseases.

Even in cases where some of the plant constituents may be a limiting factor in terms of cultivation, research or production of preparations, a broad spectrum of chemotypes the plant offers leads to the development of cultivars intended exclusively for producing medicines.

Versatile and complex nature of *Cannabis* derived pharmaceuticals suggest that more comprehensive and knowledge-based approach in legal regulations is imperative for improving drug quality and availability to patients. The regulatory environment undergoes rapid changes around the world, although there are still significant discrepancies in terms of access conditions, prescription, price, and reimbursement, as well as in terms of the level of knowledge among health professionals about the use of cannabis preparations.

Abbreviations

BCP	β -caryophyllene
Cannabis	<i>Cannabis sativa</i> var./ssp. <i>sativa</i> and <i>Cannabis sativa</i> var./ssp. <i>indica</i>
CBC	Cannabichromene
CBDA	Cannabidiolic acid
CBG	Cannabigerol
CBGA	Cannabigerolic acid
ECS	Endocannabinoid system
Hemp	<i>Cannabis sativa</i> var. <i>sativa</i>
PKS	Polyketide synthase
THC	Δ^9 -tetrahydrocannabinol
THCA	Δ^9 -tetrahydrocannabinolic acid
THCV	Tetrahydrocannabivarin
TRP	Transient receptor potential
TRPV	Transient receptor potential vanilloid type

References

- Aizpurua-Olaizola, O., Soydaner, U., Öztürk, E., Schibano, D., Sirmsir, Y., Navarro, P., Etxebarria, N., Usobiaga, A., 2016. Evolution of the cannabinoid and terpene content during the growth of *Cannabis sativa* plants from different chemotypes. *J. Nat. Prod.* 79, 324–331. <https://doi.org/10.1021/acs.jnatprod.5b00949>.
- Alexander, A., Smith, P.F., Rosengren, R.J., 2009. Cannabinoids in the treatment of cancer. *Cancer Lett.* 285, 6–12. <https://doi.org/10.1016/j.canlet.2009.04.005>.
- Baek, S.H., Kim, Y.O., Kwag, J.S., Choi, K.E., Jung, W.Y., Han, D.S., 1998. Boron trifluoride etherate on silica-A modified Lewis acid reagent (VII). Antitumor activity of cannabigerol against human oral epitheloid carcinoma cells. *Arch. Pharm. Res.* 21, 353–356.
- Bagheri, M., Mansouri, H., 2015. Effect of induced polyploidy on some biochemical parameters in *Cannabis sativa* L. *Appl. Biochem. Biotechnol.* 175, 2366–2375. <https://doi.org/10.1007/s12010-014-1435-8>.
- Banerjee, S., Snyder, S., Mechoulam, R., 1975. Cannabinoids: influence on neurotransmitter uptake in rat brain synaptosomes. *J. Pharmacol. Exp. Ther.* 194, 74–81.
- Behr, M., Sergeant, K., Leclercq, C.C., Planchon, S., Guignard, C., Lenouvel, A., Renaut, J., Hausman, J.F., Lutts, S., Guerriero, G., 2018. Insights into the molecular regulation of monolignol-derived product biosynthesis in the growing hemp hypocotyl. *BMC Plant Biol.* 18, 1–18. <https://doi.org/10.1186/s12870-017-1213-1>.
- Ben Amar, M., 2006. Cannabinoids in medicine: a review of their therapeutic potential. *J. Ethnopharmacol.* 105, 1–25. <https://doi.org/10.1016/j.jep.2006.02.001>.
- Bolognini, D., Costa, B., Maione, S., Comelli, F., Marini, P., Di Marzo, V., Parolaro, D., Ross, R., Gauson, L., Cascio, M., Pertwee, R., 2010. The plant cannabinoid D9-tetrahydrocannabivarin can decrease signs of inflammation and inflammatory pain in mice. *bph_756 677.687 Br. J. Pharmacol.* 160, 677–687.
- Booth, J.K., Page, J.E., Bohlmann, J., 2017. Terpene synthases from *Cannabis sativa*. *PLoS One* 12, 1–20. <https://doi.org/10.1371/journal.pone.0173911>.

- Borille, B.T., Ortiz, R.S., Mariotti, K.C., Vanini, G., Tose, L.V., Filgueiras, P.R., Marcelo, M.C.A., Ferrão, M.F., Anzanello, M.J., Limberger, R.P., Romão, W., 2017. Chemical profiling and classification of cannabis through electrospray ionization coupled to Fourier transform ion cyclotron resonance mass spectrometry and chemometrics. *Anal. Methods* 9, 4070–4081. <https://doi.org/10.1039/c7ay01294b>.
- Brand, E.J., Zhao, Z., 2017. Cannabis in Chinese medicine: are some traditional indications referenced in ancient literature related to cannabinoids? *Front. Pharmacol.* 8, 1–11. <https://doi.org/10.3389/fphar.2017.00108>.
- Brenneisen, R., n.d. Chemistry and analysis of phytocannabinoids and other cannabis constituents. *Marijuana Cannabinoids*, 17–49. https://doi.org/10.1007/978-1-59259-947-9_2.
- Burstein, S.H., 1999. The cannabinoid acids: nonpsychoactive derivatives with therapeutic potential. *Pharmacol. Ther.* 82, 87–96.
- Cabral, G.A., Griffin-Thomas, L., 2009. Emerging role of the cannabinoid receptor CB2 in immune regulation: therapeutic prospects for neuroinflammation. *Expert Rev. Mol. Med.* 11. <https://doi.org/10.1017/S1462399409000957>.
- Cascio, M., Gauson, L., Stevenson, L., Ross, R., Pertwee, R., 2010. Evidence that the plant cannabinoid cannabigerol is a highly potent $\alpha 2$ -adrenoceptor agonist and moderately potent 5HT_{1A} receptor antagonist: novel pharmacological actions of cannabigerol. *Br. J. Pharmacol.* 159, 129–141. <https://doi.org/10.1111/j.1476-5381.2009.00515.x>.
- Cascio, M.G., Zamberletti, E., Marini, P., Parolaro, D., Pertwee, R.G., 2015. The phytocannabinoid, Δ^9 -tetrahydrocannabivarin, can act through 5-HT_{1A} receptors to produce antipsychotic effects: THCV, 5-HT_{1A} and schizophrenia. *Br. J. Pharmacol.* 172, 1305–1318. <https://doi.org/10.1111/bph.13000>.
- Cassano, T., Calcagnini, S., Pace, L., De Marco, F., Romano, A., Gaetani, S., 2017. Cannabinoid receptor 2 signaling in neurodegenerative disorders: from pathogenesis to a promising therapeutic target. *Front. Neurosci.* 11. <https://doi.org/10.3389/fnins.2017.00030>.
- Chandra, S., Lata, H., 2017. L. - Botany and Biotechnology.
- Chandra, S., Lata, H., ElSohly, M.A., 2017a. *Cannabis sativa* L. - botany and biotechnology. *Cannabis Sativa Bot. Biotechnol.* 1–474. <https://doi.org/10.1007/978-3-319-54564-6>.
- Chandra, S., Lata, H., ElSohly, M.A., Walker, L.A., Potter, D., 2017b. Cannabis cultivation: methodological issues for obtaining medical-grade product. *Epilepsy Behav.* 70, 302–312. <https://doi.org/10.1016/j.yebeh.2016.11.029>.
- Chaohua, C., Gonggu, Z., Lining, Z., Chunsheng, G., Qing, T., Jianhua, C., Xinbo, G., Dingxiang, P., Jianguang, S., 2016. A rapid shoot regeneration protocol from the cotyledons of hemp (*Cannabis sativa* L.). *Ind. Crops Prod.* 83, 61–65. <https://doi.org/10.1016/j.indcrop.2015.12.035>.
- Chen, T., Wu, Y., Zhang, Y., Wang, B., Hu, Y., Wang, C., Jiang, H., 2012. Archaeobotanical study of ancient food and cereal remains at the Astana Cemeteries, Xinjiang, China. *PLoS One* 7, 1–9. <https://doi.org/10.1371/journal.pone.0045137>.
- Clarke, R.C., Merlin, M.D., 2016. Cannabis domestication, breeding history, present-day genetic diversity, and future prospects. *Crit. Rev. Plant Sci.* 35, 293–327. <https://doi.org/10.1080/07352689.2016.1267498>.
- Costa, L., Amaral, C., Teixeira, N., Correia-Da-Silva, G., Fonseca, B.M., 2016. Cannabinoid-induced autophagy: protective or death role? *Prostaglandins Other Lipid Mediat.* 122, 54–63. <https://doi.org/10.1016/j.prostaglandins.2015.12.006>.
- De Backer, B., Maebe, K., Verstraete, A.G., Charlier, C., 2012. Evolution of the content of THC and other major cannabinoids in drug-type cannabis cuttings and seedlings during growth of plants. *J. Forensic Sci.* 57, 918–922. <https://doi.org/10.1111/j.1556-4029.2012.02068.x>.

- De Petrocellis, L., Ligresti, A., Moriello, A.S., Allarà, M., Bisogno, T., Petrosino, S., Stott, C.G., Di Marzo, V., 2011. Effects of cannabinoids and cannabinoid-enriched *Cannabis* extracts on TRP channels and endocannabinoid metabolic enzymes: novel pharmacology of minor plant cannabinoids. *Br. J. Pharmacol.* 163, 1479–1494. <https://doi.org/10.1111/j.1476-5381.2010.01166.x>.
- Devinsky, O., Cross, H., Laux, L., Marsh, E., Miller, I., Nabbout, R., Scheffer, I.E., Thiele, E.A., Wright, S., 2017. Trial of Cannabidiol for Drug-Resistant Seizures in the Dravet Syndrome. *N. Eng. J. Med.* 376, 2011–2020. <https://doi.org/10.1056/NEJMoa1611618>.
- Di Marzo, V., 2006. The endocannabinoid system: can it contribute to cannabis therapeutics? In: Grotenhermen, F. (Ed.), *Haworth Series in Integrative Healing*. Haworth Press, New York, pp. 207–225.
- Di Marzo, V., Melck, D., Bisogno, T., De Petrocellis, L., 1998. Endocannabinoids: endogenous cannabinoid receptor ligands with neuromodulatory action. *Trends Neurosci.* 21, 521–528. [https://doi.org/10.1016/S0166-2236\(98\)01283-1](https://doi.org/10.1016/S0166-2236(98)01283-1).
- Divashuk, M.G., Alexandrov, O.S., Razumova, O.V., Kirov, I.V., Karlov, G.I., 2014. Molecular cytogenetic characterization of the dioecious *Cannabis sativa* with an XY chromosome sex determination system. *PLoS One* 9, 1–7. <https://doi.org/10.1371/journal.pone.0085118>.
- Duraisamy, G.S., Mishra, A.K., Kocábek, T., Matoušek, J., 2018. Activation of polyketide synthase gene promoter in *Cannabis sativa* by heterologous transcription factors derived from *Humulus lupulus*. *Biol. Plant.* 62, 250–260. <https://doi.org/10.1007/s10535-017-0766-z>.
- Earleywine, M., 2002. *Understanding Marijuana: A New Look at the Scientific Evidence*. Oxford University Press, USA.
- Ekstein, D., 2015. Issues and promise in clinical studies of botanicals with anticonvulsant potential. *Epilepsy Behav.* 52, 329–332. <https://doi.org/10.1016/j.yebeh.2015.07.042>.
- Fichtner, C., Moss, H., 2017. Medical marijuana and mental health: cannabis use in psychiatric practice. *Psychiatr. Times* 34.
- Flores-Sanchez, I.J., Verpoorte, R., 2008. Secondary metabolism in cannabis. *Phytochem. Rev.* 7, 615–639. <https://doi.org/10.1007/s11101-008-9094-4>.
- Fride, E., 2004. The endocannabinoid-CB1 receptor system in pre- and postnatal life. *Eur. J. Pharmacol.* 500, 289–297. <https://doi.org/10.1016/j.ejphar.2004.07.033>.
- Gagne, S.J., Stout, J.M., Liu, E., Boubakir, Z., Clark, S.M., Page, J.E., 2012. Identification of olivetolic acid cyclase from *Cannabis sativa* reveals a unique catalytic route to plant polyketides. *Proc. Natl. Acad. Sci. U.S.A.* 109, 12811–12816. <https://doi.org/10.1073/pnas.1200330109>.
- Gardner, F., 2011. Terpenoids, ‘minor’ cannabinoids contribute to ‘entourage effect’ of Cannabis-based medicines. *O Shaugnessys J. Cannabis Clin. Pract.* Autumn 18–21.
- Geissler, M., Volk, J., Stehle, F., Kayser, O., Warzecha, H., 2018. Subcellular localization defines modification and production of Δ^9 -tetrahydrocannabinolic acid synthase in transiently transformed *Nicotiana benthamiana*. *Biotechnol. Lett.* 40, 981–987. <https://doi.org/10.1007/s10529-018-2545-0>.
- Głodowska, M., 2017. *Cannabis sativa* L. and its Antimicrobial Properties - A Review, pp. 77–82.
- Grotenhermen, F., 2006. Clinical pharmacokinetics of cannabinoids. In: Russo, E.B., Grotenhermen, F. (Eds.), *Haworth Series in Integrative Healing*. Haworth Press, New York, pp. 69–116.
- Grotenhermen, F., Russo, E., Zuardi, W.A., 2017. Even High Doses of Oral Cannabidiol Do Not Cause THC-Like Effects in Humans: Comment on Merrick et al. *Cannabis and Cannabinoid Research* 1 (1), 2016 102–112. <https://doi.org/10.1089/can.2015.0004>. *Cannabis Cannabinoid Res.* 2, 1–4. <https://doi.org/10.1089/can.2016.0036>.

- Grotenhermen, F., Müller-Vahl, K., 2012. The Therapeutic Potential of Cannabis and Cannabinoids. Dtsch. Aerzteblatt Online. <https://doi.org/10.3238/arztebl.2012.0495>.
- Gugliandolo, A., Pollastro, F., Grassi, G., Bramanti, P., Mazzon, E., 2018. In vitro model of neuroinflammation: efficacy of cannabigerol, a non-psychoactive cannabinoid. Int. J. Mol. Sci. 19, 1992. <https://doi.org/10.3390/ijms19071992>.
- Hall, J., Bhattarai, S.P., Midmore, D.J., 2014. The effects of photoperiod on phenological development and yields of industrial hemp. J. Nat. Fibers 11, 87–106. <https://doi.org/10.1080/15440478.2013.846840>.
- Hall, J., Bhattarai, S.P., Midmore, D.J., 2012. Review of flowering control in industrial hemp. J. Nat. Fibers 9, 23–36. <https://doi.org/10.1080/15440478.2012.651848>.
- Hartsel, J.A., Eades, J., Hickory, B., Makriyannis, A., 2016. *Cannabis sativa* and Hemp, Nutraceuticals: Efficacy, Safety and Toxicity. Elsevier Inc. <https://doi.org/10.1016/B978-0-12-802147-7.00053-X>.
- Hermanson, D.J., Marnett, L.J., 2011. Cannabinoids, endocannabinoids, and cancer. Cancer Metastasis Rev. 30, 599–612. <https://doi.org/10.1007/s10555-011-9318-8>.
- Hill, A., Mercier, M., Hill, T., Glyn, S., Jones, N., Yamasaki, Y., Futamura, T., Duncan, M., Stott, C., Stephens, G., Williams, C., Whalley, B., 2012. Cannabidivarin is anticonvulsant in mouse and rat: cannabidivarin as an anticonvulsant. Br. J. Pharmacol. 167, 1629–1642. <https://doi.org/10.1111/j.1476-5381.2012.02207.x>.
- Hillig, K.W., Mahlberg, P.G., 2004. A chemotaxonomic analysis of cannabinoid variation in Cannabis (Cannabaceae). Am. J. Bot. 91, 966–975. <https://doi.org/10.3732/ajb.91.6.966>.
- Holland, M.L., Lau, D.T.T., Allen, J.D., Arnold, J.C., 2009. The multidrug transporter ABCG2 (BCRP) is inhibited by plant-derived cannabinoids: plant-derived cannabinoids inhibit ABCG2. Br. J. Pharmacol. 152, 815–824. <https://doi.org/10.1038/sj.bjp.0707467>.
- Huestis, M., 2005. Pharmacokinetics and metabolism of the plant cannabinoids, Δ^9 -Tetrahydrocannabinol, cannabidiol and cannabinol. In: Pertwee, R. (Ed.), *Cannabinoids, Handbook of Experimental Pharmacology*. Springer, Berlin, New York, pp. 658–683.
- Huestis, M., Smith, M., 2007. Human cannabinoid pharmacokinetics and interpretation of cannabinoid concentrations in biological fluids and tissues. In: ElSohly, M.A. (Ed.), *Marijuana and the Cannabinoids, Forensic Science and Medicine*. Humana Press, Totowa, NJ, p. 322.
- Izzo, A.A., Capasso, R., Aviello, G., Borrelli, F., Romano, B., Piscitelli, F., Gallo, L., Capasso, F., Orlando, P., Di Marzo, V., 2012. Inhibitory effect of cannabichromene, a major non-psychoactive cannabinoid extracted from Cannabis sativa, on inflammation-induced hypermotility in mice. Br. J. Pharmacol. 166 (4), 1444–1460. <https://doi.org/10.1111/j.1476-5381.2012.01879.x>.
- Jager, W., Buchabuer, G., Jirovetz, L., Fritzer, M., 1992. Percutaneous absorption of lavender oil from massage oil. J. Soc. Cosmet. Chem. 43, 49–54.
- Javid, F.A., Phillips, R.M., Afshinjavid, S., Verde, R., Ligresti, A., 2016. Cannabinoid pharmacology in cancer research: a new hope for cancer patients? Eur. J. Pharmacol. 775, 1–14. <https://doi.org/10.1016/j.ejphar.2016.02.010>.
- Kapoor, S., 2013. The inhibitory effects of cannabidiol on systemic malignant tumors. J. Pain Symptom Manag. 45, e1. <https://doi.org/10.1016/j.jpainsymman.2013.02.002>.
- Khan, M.I., Sobocińska, A.A., Czarnecka, A.M., Król, M., Botta, B., Szczylik, C., 2016. The Therapeutic Aspects of the Endocannabinoid System (ECS) for Cancer and their Development: From Nature to Laboratory. Curr. Pharm. Des. 22, 1756–1766. <https://doi.org/10.2174/1381612822666151211094901>.
- Kolikonda, M., Srinivasan, K., Enja, M., Vishwanath, S., Lippmann, S., 2015. Medical marijuana for epilepsy? Innov. Clin. Neurosci. 13, 23–26.

- Lewis, M.A., Russo, E.B., Smith, K.M., 2018. Pharmacological foundations of cannabis chemovars. *Planta Med.* 84, 225–233. <https://doi.org/10.1055/s-0043-122240>.
- Ligresti, A., 2006. Antitumor activity of plant cannabinoids with emphasis on the effect of cannabidiol on human breast carcinoma. *J. Pharmacol. Exp. Ther.* 318, 1375–1387. <https://doi.org/10.1124/jpet.106.105247>.
- Lynch, R.C., Vergara, D., Tittes, S., White, K., Schwartz, C.J., Gibbs, M.J., Ruthenburg, T.C., deCesare, K., Land, D.P., Kane, N.C., 2016. Genomic and chemical diversity in cannabis. *Crit. Rev. Plant Sci.* 35, 349–363. <https://doi.org/10.1080/07352689.2016.1265363>.
- Maione, S., Piscitelli, F., Gatta, L., Vita, D., De Petrocellis, L., Palazzo, E., de Novellis, V., Di Marzo, V., 2011. Non-psychoactive cannabinoids modulate the descending pathway of antinociception in anaesthetized rats through several mechanisms of action: phytocannabinoids in supraspinal pain control. *Br. J. Pharmacol.* 162, 584–596. <https://doi.org/10.1111/j.1476-5381.2010.01063.x>.
- Mansouri, H., Asrar, Z., Mehrabani, M., 2009. Effects of gibberellic acid on primary terpenoids and Δ^9 -tetrahydrocannabinol in *Cannabis sativa* at flowering stage. *J. Integr. Plant Biol.* 51, 553–561. <https://doi.org/10.1111/j.1744-7909.2009.00833.x>.
- Marcu, J.P., 2016. An Overview of Major and Minor Phytocannabinoids, *Neuropathology of Drug Addictions and Substance Misuse*. Elsevier Inc. <https://doi.org/10.1016/B978-0-12-800213-1.00062-6>.
- Martin, B., ElSohly, M.A., 2007. The endocannabinoid system and the therapeutic potential of cannabinoids. In: *Marijuana and the Cannabinoids, Forensic Science and Medicine*. Humana Press, Totowa, NJ, pp. 125–144.
- Massimino, L., 2017. In silico discovery of terpenoid metabolism in *Cannabis sativa*. *F1000Research* 6, 107. <https://doi.org/10.12688/f1000research.10778.1>.
- McPartland, J., Russo, E., 2006. Cannabis and cannabis extracts: greater than the sum of their parts? In: Russo, E., Grotenhermen, F. (Eds.), *Handbook of Cannabis Therapeutics: From Bench to Bedside, Haworth Series in Integrative Healing*. Haworth Press, New York, pp. 171–204.
- McCoy, M., 2017. AMRI can do NEMUS's cannabinoid chemistry. *C&EN* 95, 44–45.
- McPartland, J.M., Glass, M., Pertwee, R.G., 2009. Meta-analysis of cannabinoid ligand binding affinity and receptor distribution: interspecies differences: ligand affinity and receptor distribution of CB1. *Br. J. Pharmacol.* 152, 583–593. <https://doi.org/10.1038/sj.bjp.0707399>.
- McPartland, J.M., Guy, G.W., 2017. Models of cannabis taxonomy, cultural bias, and conflicts between scientific and vernacular names. *Bot. Rev.* 83, 327–381. <https://doi.org/10.1007/s12229-017-9187-0>.
- Mechoulam, R., 2005. Plant cannabinoids: a neglected pharmacological treasure trove. *Br. J. Pharmacol.* 146, 913–915. <https://doi.org/10.1038/sj.bjp.0706415>.
- Mechoulam, R., Hanuš, L.O., Pertwee, R., Howlett, A.C., 2014. Early phytocannabinoid chemistry to endocannabinoids and beyond. *Nat. Rev. Neurosci.* 15, 757–764. <https://doi.org/10.1038/nrn3811>.
- Morales, P., Hurst, D.P., Reggio, P.H., 2017. Molecular targets of the phytocannabinoids: a complex picture. In: Kinghorn, A.D., Falk, H., Gibbons, S., Kobayashi, J. (Eds.), *Phytocannabinoids*. Springer International Publishing, Cham, pp. 103–131.
- Munro, S., Thomas, K., Abu-Shaar, M., 1993. Molecular characterization of a peripheral receptor for cannabinoids. *Nature* 365, 61–65.
- Nikan, M., Nabavi, S.M., Manayi, A., 2016. Ligands for cannabinoid receptors, promising anticancer agents. *Life Sci.* 146, 124–130. <https://doi.org/10.1016/j.lfs.2015.12.053>.

- Pacher, P., Bátkai, S., Kunos, G., 2005. In: Pertwee, R.G. (Ed.), *Cardiovascular Pharmacology of Cannabinoids, Cannabinoids*. Springer-Verlag, Berlin/Heidelberg, pp. 599–625.
- Pagotto, U., Marsicano, G., Cota, D., Lutz, B., Pasquali, R., 2006. The emerging role of the endocannabinoid system in endocrine regulation and energy balance. *Endocr. Rev.* 27, 73–100. <https://doi.org/10.1210/er.2005-0009>.
- Pertwee, R., 2005. Pharmacological actions of cannabinoids. In: Pertwee, R. (Ed.), *Cannabinoids, Handbook of Experimental Pharmacology*. Springer-Verlag.
- Pertwee, R.G., 2008. The diverse CB₁ and CB₂ receptor pharmacology of three plant cannabinoids: Δ^9 -tetrahydrocannabinol, cannabidiol and Δ^9 -tetrahydrocannabivarin. *Br. J. Pharmacol.* 153, 199–215. <https://doi.org/10.1038/sj.bjp.0707442>.
- Perucca, E., 2017. Cannabinoids in the treatment of epilepsy: hard evidence at last? *J. Epilepsy Res.* 7, 61–76. <https://doi.org/10.14581/jer.17012>.
- Pisanti, S., Malfitano, A.M., Ciaglia, E., Lamberti, A., Ranieri, R., Cuomo, G., Abate, M., Faggiana, G., Proto, M.C., Fiore, D., Laezza, C., Bifulco, M., 2017. Cannabidiol: state of the art and new challenges for therapeutic applications. *Pharmacol. Ther.* 175, 133–150. <https://doi.org/10.1016/j.pharmthera.2017.02.041>.
- Pisanti, S., Picardi, P., D'Alessandro, A., Laezza, C., Bifulco, M., 2013. The endocannabinoid signaling system in cancer. *Trends Pharmacol. Sci.* 34, 273–282. <https://doi.org/10.1016/j.tips.2013.03.003>.
- Pollastro, F., Minassi, A., Fresu, L.G., 2018. Cannabis phenolics and their bioactivities. *Curr. Med. Chem.* 25, 1160–1185. <https://doi.org/10.2174/0929867324666170810164636>.
- Pollio, A., 2016. The name of *Cannabis*: a short guide for nonbotanists. *Cannabis Cannabinoid Res.* 1, 234–238. <https://doi.org/10.1089/can.2016.0027>.
- Pudelko, K., Majchrzak, L., Narozna, D., 2014. Allelopathic effect of fibre hemp (*Cannabis sativa* L.) on monocot and dicot plant species. *Ind. Crops Prod.* 56, 191–199. <https://doi.org/10.1016/j.indcrop.2014.02.028>.
- Pyszniak, M., Tabarkiewicz, J., Łuszczki, J., 2016. Endocannabinoid system as a regulator of tumor cell malignancy – biological pathways and clinical significance. *OncoTargets Ther.* 9, 4323–4336. <https://doi.org/10.2147/OTT.S106944>.
- Ramer, R., Fischer, S., Hausteil, M., Manda, K., Hinz, B., 2014. Cannabinoids inhibit angiogenic capacities of endothelial cells via release of tissue inhibitor of matrix metalloproteinases-1 from lung cancer cells. *Biochem. Pharmacol.* 91, 202–216. <https://doi.org/10.1016/j.bcp.2014.06.017>.
- Raymon, L., Walls, C., 2007. Pharmacology of cannabinoids. In: ElSohly, M.A. (Ed.), *Marijuana and Cannabinoids, Forensic Science and Medicine*. Humana Press, Totowa, NJ, pp. 97–123.
- Reekie, T.A., Scott, M.P., Kassiou, M., 2017. The evolving science of phytocannabinoids. *Nat. Rev. Chem.* 2, 0101. <https://doi.org/10.1038/s41570-017-0101>.
- Romano, B., Borrelli, F., Pagano, E., Cascio, M.G., Pertwee, R.G., Izzo, A.A., 2014. Inhibition of colon carcinogenesis by a standardized *Cannabis sativa* extract with high content of cannabidiol. *Phytomedicine* 21, 631–639. <https://doi.org/10.1016/j.phymed.2013.11.006>.
- Russo, E.B., 2016. Beyond cannabis: plants and the endocannabinoid system. *Trends Pharmacol. Sci.* 37, 594–606. <https://doi.org/10.1016/j.tips.2016.04.005>.
- Russo, E.B., 2011. Taming THC: potential cannabis synergy and phytocannabinoid-terpenoid entourage effects. *Br. J. Pharmacol.* 163, 1344–1364. <https://doi.org/10.1111/j.1476-5381.2011.01238.x>.
- Russo, E., Marcu, J., 2017a. Cannabis pharmacology: the usual suspects and a few promising leads. In: Kendall, D., Alexander, S. (Eds.), *Cannabinoid Pharmacology, Advances in Pharmacology*. Academic Press, an imprint of Elsevier, pp. 67–134.

- Russo, E.B., Marcu, J., 2017b. Cannabis Pharmacology: The Usual Suspects and a Few Promising Leads, first ed. Elsevier Inc. Advances in Pharmacology. <https://doi.org/10.1016/bs.apha.2017.03.004>.
- Russo, E.B., McPartland, J.M., 2003. Cannabis is more than simply Δ^9 -tetrahydrocannabinol. *Psychopharmacology (Berl.)* 165, 431–432. <https://doi.org/10.1007/s00213-002-1348-z>.
- Salgueiro, J., Ardenghi, P., Dias, M., Ferreira, M.B., Izquierdo, I., Medina, J., 1997. Anxiolytic natural and synthetic flavonoid ligands of the central benzodiazepine receptor have No effect on memory tasks in rats. *Pharmacol. Biochem. Behav.* 58, 887–891. [https://doi.org/10.1016/S0091-3057\(97\)00054-3](https://doi.org/10.1016/S0091-3057(97)00054-3).
- Sawler, J., Stout, J.M., Gardner, K.M., Hudson, D., Vidmar, J., Butler, L., Page, J.E., Myles, S., 2015. The genetic structure of marijuana and hemp. *PLoS One* 10, 1–9. <https://doi.org/10.1371/journal.pone.0133292>.
- Schafroth, M.A., Carreira, E.M., 2017. Phytocannabinoids Unraveling the Complex Chemistry and, Progress in the Chemistry of Organic Natural Products. https://doi.org/10.1007/978-3-319-45541-9_3.
- Schlicker, E., Kathmann, M., 2001. Modulation of transmitter release via presynaptic cannabinoid receptors. *Trends Pharmacol. Sci.* 22, 565–572. [https://doi.org/10.1016/S0165-6147\(00\)01805-8](https://doi.org/10.1016/S0165-6147(00)01805-8).
- Sluttenhofer, C., Yuan, L., 2017. Challenges towards revitalizing hemp: a multifaceted crop. *Trends Plant Sci.* 22, 917–929. <https://doi.org/10.1016/j.tplants.2017.08.004>.
- Schurman, L.D., Aron, H., 2017. Endocannabinoids: A Promising Impact for Traumatic Brain Injury. *Front. Pharmacol.* 8. <https://doi.org/10.3389/fphar.2017.00069>.
- Scutt, A., Williamson, E.M., 2007. Cannabinoids stimulate fibroblastic colony formation by bone marrow cells indirectly via CB2 receptors. *Calcif. Tissue Int.* 80, 50–59. <https://doi.org/10.1007/s00223-006-0171-7>.
- Sirikantaramas, S., Taura, F., Tanaka, Y., Ishikawa, Y., Morimoto, S., Shoyama, Y., 2005. Tetrahydrocannabinolic acid synthase, the enzyme controlling marijuana psychoactivity, is secreted into the storage cavity of the glandular trichomes. *Plant Cell Physiol.* 46, 1578–1582. <https://doi.org/10.1093/pcp/pci166>.
- Small, E., 2018. Dwarf germplasm: the key to giant Cannabis hempseed and cannabinoid crops. *Genet. Resour. Crop Evol.* 65, 1071–1107. <https://doi.org/10.1007/s10722-017-0597-y>.
- Soler, S., Gramazio, P., Figàs, M.R., Vilanova, S., Rosa, E., Llosa, E.R., Borràs, D., Plazas, M., Prohens, J., 2017. Genetic structure of *Cannabis sativa* var. indica cultivars based on genomic SSR (gSSR) markers: implications for breeding and germplasm management. *Ind. Crops Prod.* 104, 171–178. <https://doi.org/10.1016/j.indcrop.2017.04.043>.
- Starowicz, K., Finn, D.P., 2017. Cannabinoids and pain: sites and mechanisms of action. In: *Advances in Pharmacology*. Elsevier, pp. 437–475.
- Strike, C., Urbanoski, K., Rush, B., 2003. Who seeks treatment for cannabis-related problems? *Can. J. Public Health* 94, 351–354.
- Takeda, S., Okajima, S., Miyoshi, H., Yoshida, K., Okamoto, Y., Okada, T., Amamoto, T., Watanabe, K., Omiecinski, C.J., Aramaki, H., 2012. Cannabidiolic acid, a major cannabinoid in fiber-type cannabis, is an inhibitor of MDA-MB-231 breast cancer cell migration. *Toxicol. Lett.* 214, 314–319. <https://doi.org/10.1016/j.toxlet.2012.08.029>.
- Thomas, A., Baillie, G.L., Phillips, A.M., Razdan, R.K., Ross, R.A., Pertwee, R.G., 2009. Cannabidiol displays unexpectedly high potency as an antagonist of CB1 and CB2 receptor agonists in vitro: cannabinoid antagonism by cannabidiol. *Br. J. Pharmacol.* 150, 613–623. <https://doi.org/10.1038/sj.bjp.0707133>.

- Turcotte, C., Blanchet, M.-R., Laviolette, M., Flamand, N., 2016. The CB2 receptor and its role as a regulator of inflammation. *Cell. Mol. Life Sci.* 73, 4449–4470. <https://doi.org/10.1007/s00018-016-2300-4>.
- Velasco, G., Hernández-Tiedra, S., Dávila, D., Lorente, M., 2016. The use of cannabinoids as anticancer agents. *Prog. Neuropsychopharmacol. Biol. Psychiatry* 64, 259–266. <https://doi.org/10.1016/j.pnpbp.2015.05.010>.
- Vickery, C.R., La Clair, J.J., Burkart, M.D., Noel, J.P., 2016. Harvesting the biosynthetic machineries that cultivate a variety of indispensable plant natural products. *Curr. Opin. Chem. Biol.* 31, 66–73. <https://doi.org/10.1016/j.cbpa.2016.01.008>.
- Vyhnaněk, T., Trojan, V., Štiasna, K., Presinszká, M., Hřivna, L., Mrkvicová, E., Havel, L., 2015. Testing of DNA isolation for the identification of hemp. *Potravinárstvo* 9, 393–397. <https://doi.org/10.5219/509>.
- Vyskot, B., Hobza, R., 2015. The genomics of plant sex chromosomes. *Plant Sci.* 236, 126–135. <https://doi.org/10.1016/j.plantsci.2015.03.019>.
- Wargent, E.T., Zaibi, M.S., Silvestri, C., Hislop, D.C., Stocker, C.J., Stott, C.G., Guy, G.W., Duncan, M., Di Marzo, V., Cawthorne, M.A., 2013. The cannabinoid Δ^9 -tetrahydrocannabivarin (THCV) ameliorates insulin sensitivity in two mouse models of obesity. *Nutr. Diabetes* 3 e68–e68. <https://doi.org/10.1038/nutd.2013.9>.
- Watts, G., 2006. Science commentary: cannabis confusions. *Br. Med. J.* 332, 175–176. <https://doi.org/10.1136/bmj.332.7534.175>.
- Wenger, T., Moldrich, G., 2002. The role of endocannabinoids in the hypothalamic regulation of visceral function. *Prostaglandins Leukot. Essent. Fat. Acids* 66, 301–307. <https://doi.org/10.1054/plf.2001.0353>.
- Wilkinson, J.D., Williamson, E.M., 2007. Cannabinoids inhibit human keratinocyte proliferation through a non-CB1/CB2 mechanism and have a potential therapeutic value in the treatment of psoriasis. *J. Dermatol. Sci.* 45, 87–92. <https://doi.org/10.1016/j.jdermsci.2006.10.009>.
- Wirth, P.W., Sue Watson, E., ElSohly, M., Turner, C.E., Murphy, J.C., 1980. Anti-inflammatory properties of cannabichromene. *Life Sci.* 26, 1991–1995. [https://doi.org/10.1016/0024-3205\(80\)90631-1](https://doi.org/10.1016/0024-3205(80)90631-1).
- Zaami, S., Di Luca, A., Di Luca, N.M., Montanari Vergallo, G., 2018. Medical use of cannabis: Italian and European legislation. *Eur. Rev. Med. Pharmacol. Sci.* 22, 1161–1167.
- Zaka, M., Sehgal, S.A., Shafique, S., Abbasi, B.H., 2017. Comparative in silico analyses of *Cannabis sativa*, *Prunella vulgaris* and *Withania somnifera* compounds elucidating the medicinal properties against rheumatoid arthritis. *J. Mol. Graph. Model.* 74, 296–304. <https://doi.org/10.1016/j.jmgm.2017.04.013>.
- Zuardi, A.W., 2008. Cannabidiol: from an inactive cannabinoid to a drug with wide spectrum of action. *Rev. Bras. Psiquiatr.* 10.

Part Two

Applications and case studies for natural fibres

This page intentionally left blank

Chemical and physical characteristic of modified cotton and linen fabrics with amine-terminated dendritic polymer

13

Somaye Akbari, A. Asayesh, S. Khaliliazar, M. Razipour, N. Esmaeeli
Department of Textile Engineering, Amirkabir University of Technology (Polytechnic Tehran), Tehran, Iran

13.1 Introduction

Cellulosic fibres have been known as the important natural fibre which have been using in various fields of application such as textile, medical, agriculture (Kozłowski et al., 2009). Cotton and flax are the useful example of cellulosic fibres which have been used in textile industry from long time ago, with about 95% and 71% cellulose component, respectively (Fouk et al., 2007; Zhang et al., 2014). Flax is a natural lingo-cellulosic fibre, the eco-friendly, biodegradable and cool nature as well as, lightweight, moisture adsorption and good ventilation properties of this cellulosic fibre lead to increasing the demand for these natural fibres globally and utilizing in various fields of application (Aleeva and Koksharov, 2012), such as clothing, filtration and insulation as well as composite (Arbelaiz et al., 2005; Galashina et al., 2012). On the other hand, flax fibre indicates the high degree of crystallinity and orientation. In the microstructure of the flax fibre, larger area of crystalline region comparing with amorphous one was observed (Borsa et al., 2016; Masseteau et al., 2014). This drawback resulted in poor dyeability and compatibility of flax fibre which limited its application in various fields (Zhang et al., 2014). In order to overcome these disadvantages chemical and physical modifications have been carried out by scientist.

Atmospheric plasma treatment was employed to enhance the interfacial adhesion between flax fibre and high density polyethylene (HDPE) and unsaturated polyester. It was found that argon treated fibre and air treated fibre indicated superior adhesion prosperity for HDPE and polyester matrixes, respectively. Moreover, presence of new functional group (O=C=O) on the fibre surface through plasma treatment can improve flax fibre chemical properties (Bozaci et al., 2013). Several different methods have been conducted to improve dyeability of flax fibre. Urea pretreatment of linen fabric revealed the levelness and dye uptake enhancement of the modified fabric. Although, urea modified flax fibre showed a tiny decrease in the fibre strength (Sun et al., 2011). Ultrasonic environment in flax fibre dyeing was used to improve the affinity of reactive dye to the flax fibre and increase the dyeing rate of the fibre

via providing additional momentum to the dye molecules in contact with the fibre surface (Fakin et al., 2005). In another work, utilizing rare-earth chloride ions in flax fibre dyeing not only improved the dyeability of the fibre by reducing the crystallinity and orientation degree of the flax fibre but also increased its compatibility (Qingxia, 1992). Modified flax fibre under mild alkali/ultrasound condition revealed the decrease in the porosity of the fibre in mesoporous range. However, this treatment didn't alter the flax fibre diameter (Borsa et al., 2016). It was reported that increase in sodium hydroxide concentration resulted in improving dyeing rate of flax fibre (Wu et al., 2007). The properties of differently printed and easy-care finished linen fabrics have been also investigated. For this purpose, linen fabrics were screen-printed with reactive dyes, vat dyes and pigments, and digitally printed with reactive dyes. Based on the results, the areal density and rigidity of the fabric increased, while air permeability decreased by printing. Tensile strength and abrasion resistance remained unchanged. Fastness to washing, rubbing and light were good for all printed linen samples, except for the digitally printed reactive dyes. The applied easy-care finishing was not suitable for the printed and unprinted linen fabrics, due to the high loss in strength. On the one hand, cross-linking improved crease recovery angles and appearance after washing and significantly decreased the stiffness of linen fabrics, whilst, decreased the fabric strength and abrasion resistance to an undesirable extent (Tavčer et al., 2011). The effect of plasma treatment on the surface characteristics of linen fabric was evaluated. Plasma treatment caused remarkable increase of wettability, wick-ability, surface energy and O/C ratio, and decrease of water contact angle and deterioration of the waxy outer layer of the fibres. Moreover, the amount of surface improvement was dependent on the time of plasma treatment, and most of the improvements were found to be stable during 2 weeks of storage after the plasma treatment (Szabó et al., 2015). Furthermore, the effect of linen fabrics modification with health promoting products such as vitamin E, beeswax and natural silk protein on their physical and chemical properties were investigated (Marszałek et al., 2014). The results revealed that enhancing linen fabrics with health promoting products improves their handle, whilst decreases the breaking force and worsens the thread slippage index parameter in stitches. However, these values are still within the limits required for linen fabrics used for clothing. Modification has no negative effect on the biodegradation process and whiteness degree, meanwhile lowers the hygroscopicity, air permeability and, in some cases, water absorption of the fabric. The traditional alkaline preparation, biopreparation with two commercial pectinase enzymes, and bleach-ability of linen fabrics were considered. All the applied treatments drastically decreased the dynamic water contact angle and increased the energy of the fibre surface. One of the enzymes that were used for biopreparation was very efficacious in improving the wicking of the linen fabric, whilst the other had a great lightning effect on the fabric colour. There was a direct correlation between the apparent capillary radius, fabric colour and bleach-ability of the differently scoured linen fabrics (Csiszar, 2012).

On the other hand, cotton has been become popular fibre due to its excellent properties such as nontoxicity, biocompatibility, high water absorbency and moisture regain as well as biodegradation, softness and affinity to skin and ease of fabrication into many textile products (Wang and Lewis, 2002). However, cotton fibre suffers

from some disadvantages including inferior strength, crease resistance and resistance toward microbes, besides low dye ability towards anionic dyes, which often limit its application (Ghosh et al., 2010; Chattopadhyay and Patel, 2011). In order to improve cotton properties, different modification methods such as grafting (Monier and El-Sokkary, 2012; Takács et al., 2005; Broadbent and Lewis, 2000), plasma (Temmerman and Leys, 2005) and enzymatic treatment (Ibrahim et al., 2007) as well as treatment with nanoparticles (Chattopadhyay and Patel, 2011) and surfactants (Pisuntornsug et al., 2002) were applied on cotton fabrics. For instance, Arian et al. (Arain et al., 2013) reported that the treatment of cotton fabric by grafting with the combination of chitosan with AgCl–TiO₂ colloid showed better antibacterial effect than the cotton fabric treated with chitosan. Moreover, the modified cotton showed improved tensile strength and wrinkle recovery angle (WRA). Grafting of polyurethane onto the surface of cotton fabric provides the high washability and anti-crease property of the treated samples (Yeju et al., 2005). According to the literatures, grafting of cotton with synthesized molecules (polyamide-epichlorohydrin) (Burkinshaw et al., 1990), biomolecules (chitosan) (Srisuk and Srikulkit, 2017), improve the flexibility, crease resistance and moisture regain of the fabric. The air plasma treated cotton fabric also exhibited enhancement in hydrophobicity which resulted in more absorbance of azadirachtin in presence of citric acid as cross-linker and provided antibacterial effect on modified cotton fabric (Vaideki et al., 2008). The effects of different resin finishing agents on cotton fabric dyed with reactive dye were investigated. The treated fabric properties such as the wrinkle recovery, tensile strength, dimensional stability, stiffness, abrasion resistance and colour strength were evaluated. Melamine formaldehyde resin treated fabric exhibited a higher crease recovery angle, better smoothness and higher bending length due to higher cross-linking with cellulose. The colour strength decreased by the resin treatments, whilst the fastness properties were unchanged (Tania et al., 2018).

Dyeing cotton fabric with anionic dyes (reactive, direct and acidic dyes) essentially need a large quantity of salt, NaCl or Na₂SO₄ and alkaline conditions to achieve an efficient dye uptake of fabric, through facilitate the migration of dye molecules from bath to fabric. Regarding to the growing concerns about environmental issues all around the world, studies mostly focus on dyeing technology of cellulosic fabrics with anionic dyes without salt and alkali (Soleimani-Gorgani et al., 2015). This strategy is categorized into two parts: the first is the development of hetero- and hemibifunctional dyes and 'low – salt' dyes (Zhang et al., 2008a). The second is the development of a cross-linking agent (Hayati et al., 2011). Among these methods, modification of cellulosic fibres or fabrics through introducing cationic groups, which is called cationization, especially amine functional groups has received considerable attention from 2 decades ago (Burkinshaw et al., 2000). The cotton fabric reacted with quaternary compound containing an acrylamide residue using pad-dry-cure process; it was reported that modified fabrics could be dyed with reactive dyes without using salt or alkali. The modified cotton fabric showed adequate wash fastness and light fastness (Wang and Lewis, 2002). In a study, the cationic hyperbranched PAMAM-chitosan was applied onto cotton fabric and it indicated a good antibacterial effect (Klaykruayat et al., 2010).

Over the recent decades, dendrimers as a class of macromolecules has been attract great deal of attention due to its highly branched structure of great regularity, a compact shape and large number of reactive end groups as well as room between the branches for trapping guest molecules such as contaminant, dye, and drug (Gao and Yan, 2004). Poly(amidoamine) dendrimers (PAMAM) is one of the well-known and efficient dendrimers using in drug delivery systems, enhancing polymer properties, additives as well as nanotechnology (Ilunga and Meijboom, 2019; Svenson and Tomalia, 2012). Particularly, the applications of amine-terminated dendritic polymer in textile sciences have been investigated properly (Akbari and Kozłowski, 2018).

Dendrimer pretreated cotton was displayed remarkable colour strength enhancement, even when dyeing had been carried out in the absence of both electrolyte and alkali (Burkinshaw et al., 2000). The printed cotton fabric grafted with biocompatible PAMAM dendrimer showed the higher level of reactive dye fixation than the printed unmodified one with PAMAM dendrimer. Therefore, the modification of cotton fabrics with PAMAM dendrimer might omit the pre-treatments which are environmentally unfriendly process (Soleimani-Gorgani et al., 2015). Other characteristic such as UV adsorption and flame retardancy also investigated by Zhang et al. (Zhang et al., 2008b).

The aim of this chapter was to determine the potential of modified both cotton and linen fabrics with PAMAM hyperbranched dendritic polymers in enhancing colour strength of fabrics in 'salt-free' dyeing method with acidic dyes. Also, the effect of PAMAM hyperbranched dendritic polymers on physical and chemical properties of modified fabrics including air permeability, strength, crease recovery angle, stiffness, antibacterial properties and moisture regains were determined.

13.2 Cotton and linen fabrics modification procedure by amine-terminated dendritic polymer

Cotton and linen fabrics with the same yarns count in both weft and wrap directions were immersed in a 1% solution of polyamidoamine hyperbranched dendritic polymer in aqueous solution for 2 min at room temperature. Then, samples were padded (Ernst Benz-Textile Machine) with 100% pick up. In following, samples were dried for 1 min at 80°C, and then cured for 4 min at 160°C. Finally, the samples were rinsed with hot and cold water to remove any un-reactant materials.

It is worth mention that the pad-dry-cure methods for modification of fabrics prefer compared to the exhaustion methods has faster operation and higher efficiency (Kozłowski and Muzyczek, 2017).

13.2.1 Characterization of modified cotton and linen fabrics

13.2.1.1 Dyeing

First, modified and unmodified cotton and linen fabrics were immersed in acetic acid aqueous solution for 10 min at 40°C. The samples were brought out from the bath and

two acidic dyes, Acid Red 1 and Acid Red 42, were added to the solution separately. Second, samples were immersed in two dyeing solutions prepared as mentioned above and the fabrics were dyed with the rate of 2°C/min to the boiling point. Finally, dyed fabrics were rinsed thoroughly with hot and cold water to remove unreacted dye molecules. The colour strength of dyed samples was measured by reflectance spectrophotometer (Color-Eye 7000A, Gretag Macbeth) using Kubelka-Munk equation, as expressed in Eq. (13.1). R is the absolute reflectance of the dyed samples at the maximum absorption wavelength of C.I. Acid Red 1 and C.I. Acid Red 42 which are 505 and 512 nm, respectively.

$$K/S = (1 - R)^2 / 2R \quad (13.1)$$

13.2.1.2 Physical properties characterization

According to ASTM –D1388 test method, wrinkle recovery angle of modified and unmodified fabrics was measured in wrap and weft direction for both cotton and linen fabrics. Bending length of fabrics were measured in order to estimate the stiffness of samples according to ASTM-D 1388 test method using stiffness tester (Shirley, England).

The tensile strength of cotton and linen fabrics were measured by Instron tensile tester machine according to ASTM –D 5035 test method in both wrap and weft directions. The tensile strength of cotton and linen fabrics was measured using tensile strength tester (Instron 5566) with a cross head speed of 300 mm/min and a gauge length of 20 cm. From each fabric type in modified and unmodified state, five strip specimens of the size 30 cm × 6 cm were cut in the wrap and weft directions and tested respectively. Furthermore, air permeability of modified and unmodified both cotton and linen fabrics were measured according to ASTM-D737 test method. Also, moisture content and moisture regain of sample were evaluated by Sartorius Moisture Analyzer model MA50, Germany equipped with IR lamp.

13.2.1.3 Antibacterial test

Antibacterial activity of the unmodified and modified cotton fabrics were tested against gram-positive *S. aureus* and gram-negative *E. coli* based on the colony forming count method as described by ATCC100 standard test method.

13.3 Effect of modified cotton and linen fabrics by amine-terminated dendritic polymers

13.3.1 Dying effect

The host–guest properties of dendrimer and guest molecules via surface attachment by ion binding and interior encapsulation by hydrophilic interactions and hydrogen-bond interactions have been investigated by various researchers (Baars and Meijer, 2000;

Cheng et al., 2008). Among various dendrimers and guest molecules, the relationships of electrostatic interaction and encapsulation between amine-terminated dendrimers such as PPI or PAMAM dendrimer and negatively charged molecules are interesting (Cheng et al., 2008). The host–guest reactions of amine-terminated dendritic group on the cotton and linen fabrics are proposed in this paper. Anionic dye adsorption was chosen as the guest models to investigate the modified fabric potential in the host–guest reactions.

The presence of amine functional groups on the modified surfaces could improve the affinity of the acidic dyes to the fabric, due to the ionic and polar interaction between positive charged amine groups on the cellulose fabrics and the negative charge of acidic dyes (Burkinshaw et al., 2000). Therefore, to investigate the efficiency and success of the modified fabrics with the amine-terminated dendritic polymer; samples were dyed with monosulphonate and disulphonate dyes. As a result, the K/S values of samples at the maximum absorption wavelength of the dyes were calculated. As it can be seen in Figs 13.1 and 13.2, the K/S values of the modified cotton and linen fabrics, respectively, for both acidic dyes are significantly higher than the unmodified samples.

Based on the results, the higher K/S value of the modified cotton fabrics dyed with Acid Red one attributed to the more affinity of the disulphonate dye comparing to the monosulphonate one. On the other hand, the slight difference in K/S value of the dyed linen fibres with Acid Red 1 and Acid Red 42 can be related to the high crystalline structure of them (Borsa et al., 2016).

However, the higher K/S values of linen fabrics in comparison with cotton ones were investigated may be due to the higher efficiency of grafting reaction between linen fabrics and amine-terminated dendritic groups on the surface.

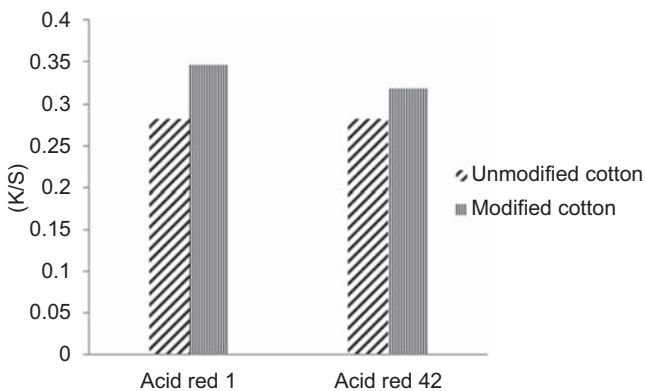

Figure 13.1 The K/S values of the modified and unmodified cotton fabrics.

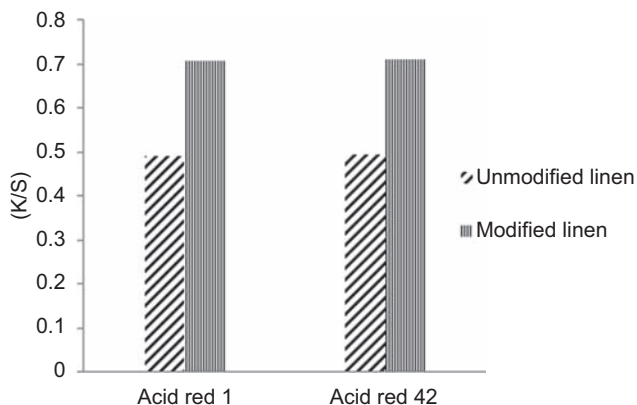

Figure 13.2 The K/S values of the modified and unmodified linen fabrics.

13.3.2 Physical properties analysis

13.3.2.1 Wrinkle recovery angle

The fabric ability to recover from induced wrinkle or resistance against wrinkle is one of the significant properties of textile fabrics. Due to the cellulosic fabric structure, which results in easily wrinkling, this characteristic has become more important in their textile application (Hashem et al., 2003). In this research, the wrinkle recovery angle (WRA) of cotton and linen fabrics was measured in two warp and weft directions. Fig. 13.3 illustrates that the modified linen fabrics with amine-terminated

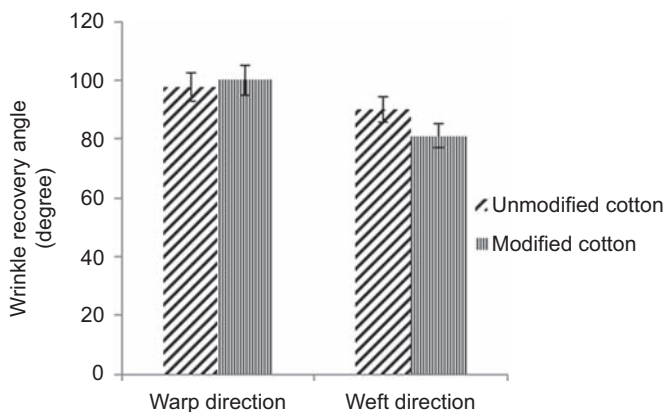

Figure 13.3 The wrinkle recovery angle (WRA) for the modified and unmodified cotton fabrics.

dendritic groups exhibit higher WRA, which clarifies the role of dendrimer in reducing wrinkling. Wrinkles in cellulosic fibres, are resulted of the slippage of the cellulose chains in amorphous region applying the distortion force, which results in reforming the weak hydrogen bonds at new location that cause wrinkles (Hsu et al., 2001; Akpan and Hameed, 2014). Unlike linen fabric, as it is shown in Fig. 13.4, modification of cotton fabric with amine-terminated dendritic groups lead to decrease in WRA of fabric in weft direction.

According to the analysis of variances (ANOVA), modification of the fabric has a significant effect on the fabric's wrinkle recovery angel in both warp and weft direction, except for cotton fabric, in which the wrinkle recovery angel in warp direction has not been affected through grafting with amine-terminated dendritic groups (Table 13.1).

13.3.2.2 Bending length

Bending length of modified and unmodified cotton and linen fabrics are illustrated in Figs 13.5 and 13.6, respectively. Figures reveal that the bending length of both fabrics in both warp and weft directions decreases as a results of modification of the fabrics with amine-terminated dendritic groups. Since, bending length is one of the factors affecting fabric handle, it can be concluded that modification of the fabric with dendrimer improves the fabric handle.

According to the analysis of variances, modification of the fabric has a remarkable effect on the fabric's bending length in both warp and weft direction, but in cotton fabric the effect of modification on the bending length in weft direction is not significant (Table 13.2).

13.3.2.3 Tensile strength

The average breaking strength of the fabrics is presented in Table 13.3. It illustrates that modification of the fabrics with dendritic polymers enhances the fabric's strength

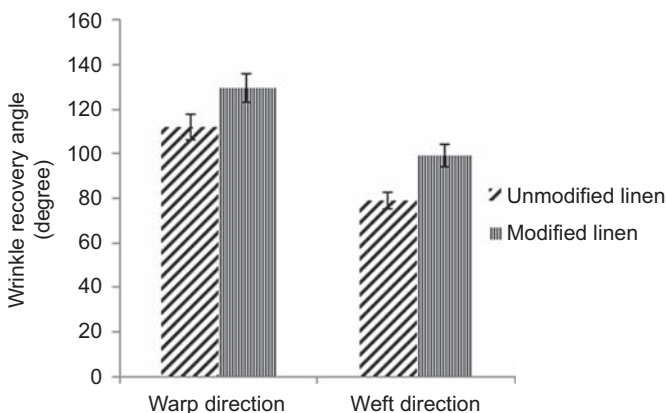

Figure 13.4 The wrinkle recovery angle (WRA) for the modified and unmodified linen fabrics.

Table 13.1 Analysis of variances for wrinkle recovery angel of cotton fabrics.

ANOVA					
	Sum of squares	df	Mean square	F	Sig.
Between groups	1014.950	3	338.317	54.788	0.000
Within groups	98.800	16	6.175		
Total	1113.750	19			

Tukey HSD ^a				
VAR00001	N	Subset for alpha = 0.05		
		1	2	3
4.00	5	83.2000		
2.00	5		88.6000	
1.00	5			99.0000
3.00	5			100.2000
Sig.		1.000	1.000	0.870

Means for groups in homogeneous subsets are displayed. 1. Unmodified state in warp direction. 2. Unmodified state in weft direction. 3. Modified state in warp direction. 4. Modified state in weft direction.

^aUses harmonic mean sample size = 5.000.

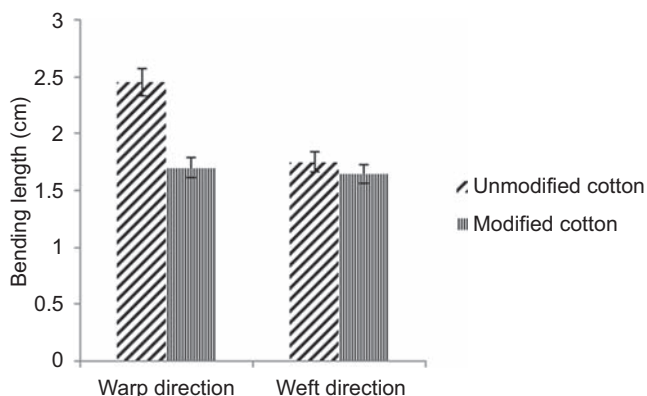

Figure 13.5 The Bending length of the modified and unmodified cotton fabrics.

in both directions. It seems that the presence of amine-terminated dendritic groups on the surface of cellulosic fabrics enhanced strength may be due to the more ionic and hydrogen bonding related to the abundant amine groups on the surface which make some cross-link between cellulosic chain of cotton and linen fabrics. According to the analysis of variances, in case of cotton fabric in both weft and warp direction, this difference is statistically significant; However, in the case of the linen fabric,

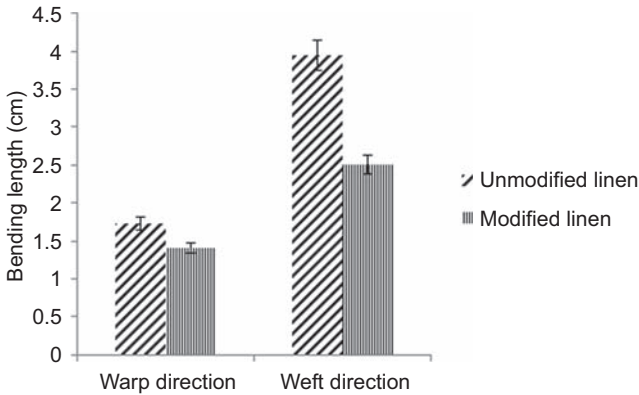

Figure 13.6 The Bending length of the modified and unmodified linen fabrics.

Table 13.2 Analysis of variances for bending length of cotton fabric.

ANOVA					
	Sum of squares	df	Mean square	F	Sig.
Between groups	2.746	3	0.915	43.140	0.000
Within groups	0.764	36	0.021		
Total	3.509	39			

Tukey HSD ^a				
VAR00001	N	Subset for alpha = 0.05		
		1	2	3
2.00	10	1.6200		
4.00	10	1.7450		
3.00	10		1.8850	
1.00	10			2.3150
Sig.		0.063	1.000	1.000

Means for groups in homogeneous subsets are displayed.

^aUses harmonic mean sample size = 10.000.

this difference is statistically insignificant in both warp and weft directions (P value = .477 and .449 respectively).

The increase in the strength of the fabric as results of grafting with amine-terminated dendritic groups on the surface can be attributed to the formation of ionic bonds on the cotton and linen fabrics, which prevents the slippage of molecular chains. Consequently, the fabric strength increases. These results confirm the result of the wrinkle recovery angel.

Table 13.3 Tensile strength of the unmodified and modified cotton and linen fabrics.

Fabric	Tensile strength in the warp direction (N)	Tensile strength in the weft direction (N)
Unmodified cotton	195	170
Modified cotton	210	198
Unmodified linen	197	366
Modified linen	202	386
Total	13590.832	9

13.3.2.4 Air permeability

Air permeability of modified and unmodified both cotton and linen fabrics were measured using air permeability testing apparatus, under a pressure of 50 Pa and the results are shown in Fig. 13.7. The Figure demonstrates that modification of the fabrics with amine-terminated dendritic groups on the surface, leads to decrease in the fabric's air permeability. It seems that the connection of bulk highly branched structure to the surface of the fabrics causes this decrement.

The decrease in the air permeability as a result of fabric modification is more obvious in the linen fabric, as it is in confirmation of statistical results (Table 13.4). It can be attributed to the fact that, the reaction of dendrimer groups on the linen fibres is more pronounced. While, in case of cotton fabric, according to the analysis of variances (Table 13.4), this difference is statistically insignificant.

**Figure 13.7** Air permeability of the modified and unmodified cotton and linen fabrics.

Table 13.4 Analysis of variances for air permeability of cotton and linen fabrics.

ANOVA					
	Sum of squares	df	Mean square	F	Sig.
Between groups	181087.350	3	60362.450	395.430	.000
Within groups	2442.400	16	152.650		
Total	183529.750	19			

Duncan ^a				
VAR00001	N	Subset for alpha = 0.05		
		1	2	3
2.00	5	48.6000		
1.00	5	52.4000		
4.00	5		206.0000	
3.00	5			266.0000
Sig.		0.633	1.000	1.000

1. Unmodified cotton. 2. Modified cotton. 3. Unmodified linen. 4. Modified linen.

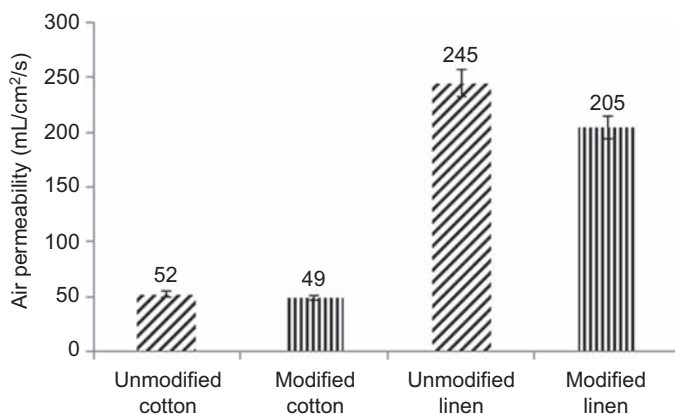
^aUses Harmonic Mean Sample Size = 5.000.

It is worth to mention that this result has conformity to the claim of grafting more amine-terminated dendritic groups on the surface molecules to linen fabrics which results in higher K/S values of modifies sample comparing to unmodified ones, respectively.

13.3.2.5 Moisture regain

Moisture regain was tested as a hydrophilic property of modified fabrics. The cotton and linen fabrics are well-known fabrics as the hydrophilic ones. However, any modification methods for more adsorption make them more comfort in further application. [Table 13.5](#) reveals the moisture regain of the cotton and linen fabric after modification with amine-terminated dendritic polymer. It is concluded that the presence of amine functional groups enhanced the wettability of both cotton and linen fabrics.

Colour strength and higher moisture regain results; both confirm the efficiency and success of the modification of cotton and linen fabrics with amine-terminated dendritic

Table 13.5 Moisture regain (%) of unmodified and modified cotton and linen fabrics.

Fabrics	Modified	Unmodified
Cotton	3.31	2.84
Linen	4.25	4.09

polymer in improving wettability and providing host–guest property of modified cellulosic fabrics. Host–guest chemistry of amine-terminated dendrimer which grafted on fabrics is defined as an electrostatic interaction and encapsulation between abundant amine groups of dendrimer and negatively charged guest molecules like water and dye molecules (Khaliliazar et al., 2016).

13.3.2.6 Antibacterial properties



The antibacterial properties of amine-terminated dendritic polymers such as PAMAM dendrimer against *S. aureus* and *E. coli* bacteria has been investigated on cotton fabrics (Klaykruayat et al., 2010). Furthermore, the effect of these two kinds of bacteria as a model for Gram-positive and Gram-negative ones examined on the poly lactic acid films and electrospun fibres after modification with poly propylene imine dendrimer of generation two. Generally, the antibacterial activities of amine-terminated dendritic polymers are related to the interaction between polycationic structures and anionic cell membranes of the bacteria (Khaliliazar et al., 2016). As evidence, the antibacterial activity of the modified and unmodified cotton fabrics reveal in Table 13.6. Results indicate that more than 99.9% of both bacteria were killed by the antibacterial activity of the modified cotton fabric due to the presence of abundant amine groups on the surfaces.

13.4 Future trends

Progress of science and technologies in surface modification of polymers and fabrics have been produced fabrics with new features. Among various novel technologies, applications of nano- and biomaterials have been concerned in textile industries due to the unique properties of these materials. Dendrimers as one of the nano-size materials are new artificial macromolecules characterized with treelike topological structures, highly branched structures of great regularity, compact shapes, large number of (reactive) end groups, and room between the branches.

This chapter book investigates the effect of amine-terminated dendritic polymer on physical and chemical properties of cotton and linen fabrics. It was found that the dye adsorption and moisture regain of modified cotton and linen fabrics increased, which represent the host–guest properties in modified fabrics. Tensile strength enhancement along with increase of wrinkle recovery angel and decrease of bending length, all indicate the improvement of physical properties of cotton and linen fabrics through grafting with amine-terminated dendritic polymer. However, the air permeability of fabrics decreased after this treatment. The antibacterial activity of the modified cellulosic fabrics also improved. The results reveal that this kind of modification could enhance the chemical and physical properties of cotton and linen fabrics for further application.

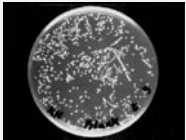
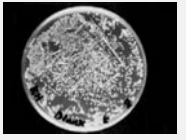
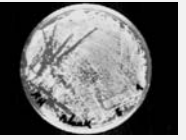
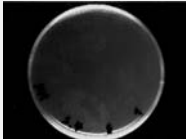
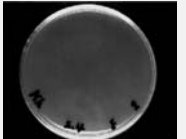
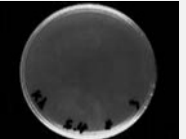
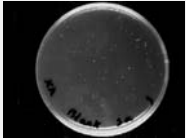
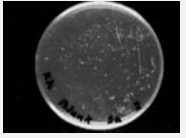
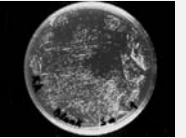
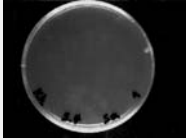
Table 13.6 Antibacterial results of the modified and unmodified cotton fabrics.

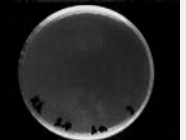
Concentration (number of bacteria in 100 mL of suspension)	10^4	10^5	10^6	Antibacterial effect
<i>E. coli</i>				
Unmodified cotton fabrics				—
Modified cotton fabrics				>99.99%
<i>S. aureus</i>				
Unmodified cotton fabrics				—
Modified cotton fabrics				>99.99%

13.5 Sources of further information and advice

Enhancing chemical and physical properties of modified cotton and linen fabrics with amine-terminated dendritic polymers was the goal of functionalization of fabrics by dendritic polymers. Improvement of colour strength on modified fabrics reduces textile wastewater. As a result, environmental pollution is reduced, which is the most important concern in the 21st century. Other chemical improvements such as more moisture adsorption and antibacterial properties as well as an enhancement on physical properties are the benefit of modification of cotton and linen fabrics by dendritic polymers.

Among various kind of dendritic polymers including hyperbranched, dendrigraft, dendron, and dendrimer, hyperbranched polymers have to concern more attention due to the price, particularly in textile applications. Nevertheless, it seems that this modification is not beneficial for the usual application with regard to the final price. However, it is worthwhile for technical textile such as medical gauzes, tampons, and pads as well as composites additives.

References

- Akbari, S., Kozłowski, R.M., 2018. A review of application of amine-terminated dendritic materials in textile engineering. *J. Text. Inst.* 1–8.
- Akpan, U., Hameed, B., 2014. Development and photocatalytic activities of TiO₂ doped with Ca–Ce–W in the degradation of acid red 1 under visible light irradiation. *Desalination Water Treat.* 52 (28–30), 5639–5651.
- Aleeva, S., Koksharov, S., 2012. Chemistry and technology of biocatalyzed nanoengineering of linen textile materials. *Russ. J. Gen. Chem.* 82 (13), 2279–2293.
- Araïn, R.A., Khatri, Z., Memon, M.H., Kim, I.-S., 2013. Antibacterial property and characterization of cotton fabric treated with chitosan/AgCl–TiO₂ colloid. *Carbohydr. Polym.* 96 (1), 326–331.
- Arbelaiz, A., Cantero, G., Fernandez, B., Mondragon, I., Ganan, P., Kenny, J., 2005. Flax fiber surface modifications: effects on fiber physico mechanical and flax/polypropylene interface properties. *Polym. Compos.* 26 (3), 324–332.
- Baars, M.W., Meijer, E., 2000. Host-Guest Chemistry of Dendritic Molecules. *Dendrimers II*. Springer, pp. 131–182.
- Borsa, J., László, K., Boguslavsky, L., et al., 2016. Effect of mild alkali/ultrasound treatment on flax and hemp fibres: the different responses of the two substrates. *Cellulose* 23 (3), 2117–2128.
- Bozaci, E., Sever, K., Sarikanat, M., et al., 2013. Effects of the atmospheric plasma treatments on surface and mechanical properties of flax fiber and adhesion between fiber–matrix for composite materials. *Compos. B Eng.* 45 (1), 565–572.
- Broadbent, P., Lewis, D., 2000. Modification of cotton cellulose with sodium benzoylthioglycollate and its effect on dyeability with disperse dyes. Part 2: application of sodium benzoylthioglycollate to cotton fabric. *Dyes Pigments* 45 (1), 35–41.
- Burkinshaw, S., Lei, X., Lewis, D., Easton, J., Parton, B., Phillips, D., 1990. Modification of cotton to improve its dyeability. Part 2—pretreating cotton with a thiourea derivative of polyamide—epichlorohydrin resins. *J. Soc. Dye. Colour.* 106 (10), 307–315.

- Burkinshaw, S., Mignanelli, M., Froehling, P., Bride, M., 2000. Dyes Pigments 47, 259–267.
- Chattopadhyay, D., Patel, B., 2011. Modification of cotton textiles with nanostructural zinc particles. *J. Nat. Fibers* 8 (1), 39–47.
- Cheng, Y., Wu, Q., Li, Y., Xu, T., 2008. External electrostatic interaction versus internal encapsulation between cationic dendrimers and negatively charged drugs: which contributes more to solubility enhancement of the drugs? *J. Phys. Chem. B* 112 (30), 8884–8890.
- Csiszar, E., 2012. Surface properties and residual chromophore content of differently pretreated linen fabrics. *Text. Res. J.* 82 (19), 2030–2040.
- Fakin, D., Golob, V., Kreze, T., Le Marechal, A.M., 2005. Ultrasound in the pretreatment processing of flax fibers. *AATCC Rev.* 5 (9).
- Foulk, J.A., Dodd, R.B., McAlister, D., Chun, D., Akin, D.E., Morrison, H., 2007. Flax-cotton fiber blends: miniature spinning, gin processing, and dust potential. *Ind. Crops Prod.* 25 (1), 8–16.
- Galashina, V., Moryganov, P., Dymnikova, N., 2012. Bio-protected flax nanocomposites as basis for manufacturing of high-tech eco-products. *Russ. J. Gen. Chem.* 82 (13), 2270–2278.
- Gao, C., Yan, D., 2004. Hyperbranched polymers: from synthesis to applications. *Prog. Polym. Sci.* 29 (3), 183–275.
- Ghosh, S., Yadav, S., Vasanthan, N., Sekosan, G., 2010. A study of antimicrobial property of textile fabric treated with modified dendrimers. *J. Appl. Polym. Sci.* 115 (2), 716–722.
- Hashem, M., Hauser, P., Smith, B., 2003. Wrinkle recovery for cellulosic fabric by means of ionic crosslinking. *Text. Res. J.* 73 (9), 762–766.
- Hayati, B., Mahmoodi, N.M., Arami, M., Mazaheri, F., 2011. Dye removal from colored textile wastewater by poly (propylene imine) dendrimer: operational parameters and isotherm studies. *Clean Soil Air Water* 39 (7), 673–679.
- Hsu, Y.-C., Chen, J.-T., Yang, H.-C., Chen, J.-H., Fang, C.-F., 2001. Ozone decolorization of mixed-dye solutions in a gas-induced reactor. *Water Environ. Res.* 73 (4), 494–503.
- Ibrahim, N., Gouda, M., El-Shafei, A., Abdel-Fatah, O., 2007. Antimicrobial activity of cotton fabrics containing immobilized enzymes. *J. Appl. Polym. Sci.* 104 (3), 1754–1761.
- Ilunga, A.K., Meijboom, R., 2019. A review of dendrimer-encapsulated metal nanocatalysts applied in the fine chemical transformations. *Catal. Lett.* 149 (1), 84–99.
- Khalilizar, S., Akbari, S., Kish, M., 2016. Modification of poly (L-lactic acid) electrospun fibers and films with poly (propylene imine) dendrimer. *Appl. Surf. Sci.* 363, 593–603.
- Klaykrueyay, B., Siralermukul, K., Srikulkit, K., 2010. Chemical modification of chitosan with cationic hyperbranched dendritic polyamidoamine and its antimicrobial activity on cotton fabric. *Carbohydr. Polym.* 80 (1), 197–207.
- Kozłowski, R., Kicińska-Jakubowska, A., Muzyczek, M., 2009. *Natural Fibres for Interior Textiles*. Elsevier, Interior Textiles, pp. 3–38.
- Kozłowski, R., Muzyczek, M., 2017. *Natural Fibers: Properties, Mechanical Behavior, Functionalization and Applications*. *Natural Fibers: Properties, Mechanical Behavior*, 1–393. Nova Science Publishers, Inc., Cambridge.
- Marszałek, R., Binkowska, B., Sapieja, A., Hernik, T., Marcinowska, B., 2014. Modification of linen fabrics with health promoting products and its effect on the use properties of the fabrics and natural environment. *Fibres Text. East. Eur.* 6 (108), 63–68.
- Masseteau, B., Michaud, F., Irlle, M., Roy, A., Alise, G., 2014. An evaluation of the effects of moisture content on the modulus of elasticity of a unidirectional flax fiber composite. *Compos. Appl. Sci. Manuf.* 60, 32–37.
- Monier, M., El-Sokkary, A., 2012. Modification and characterization of cellulosic cotton fibers for efficient immobilization of urease. *Int. J. Biol. Macromol.* 51 (1–2), 18–24.

- Pisuntornsug, C., Yanumet, N., O'Rear, E.A., 2002. Surface modification to improve dyeing of cotton fabric with a cationic dye. *Color. Technol.* 118 (2), 64–68.
- Qingxia, D., 1992. Application of rare-earth metal compounds in dyeing flax. *Text. Aux.* 4, 007.
- Soleimani-Gorgani, A., Najafi, F., Karami, Z., 2015. Modification of cotton fabric with a dendrimer to improve ink-jet printing process. *Carbohydr. Polym.* 131, 168–176.
- Srisuk, S., Srikulkit, K., 2017. Properties evaluation of sodium nitrite treated chitosan-cotton fabric. *J. Met. Mater. Miner.* 18 (2).
- Sun, H., Jiang, X., Shen, Y., Chen, C., 2011. The improvement of dyeability of flax fibre by urea treatment. *Pigment Resin Technol.* 40 (1), 36–41.
- Svenson, S., Tomalia, D.A., 2012. Dendrimers in biomedical applications—reflections on the field. *Adv. Drug Deliv. Rev.* 64, 102–115.
- Szabó, O.E., Csiszár, E., Tóth, A., 2015. Enhancing the surface properties of linen by non-thermal atmospheric air-plasma treatment. *Open Chem.* 13 (1), 570–576.
- Takács, E., Wojnarovits, L., Borsa, J., Papp, J., Hargittai, P., Korecz, L., 2005. Modification of cotton-cellulose by preirradiation grafting. *Nucl. Instrum. Methods Phys. Res. Sect. B Beam Interact. Mater. Atoms* 236 (1–4), 259–265.
- Tania, I.S., Kabir, S., Uddin, Z., 2018. Effects of resin treatments on the quality of cotton fabric dyed with reactive dye. *Fibres Text. East. Eur.*
- Tavčer, P.F., Košir, S., Csiszar, E., 2011. Properties of differently printed and easy-care finished linen fabrics. *Color. Technol.* 127 (3), 194–199.
- Temmerman, E., Leys, C., 2005. Surface modification of cotton yarn with a DC glow discharge in ambient air. *Surf. Coat. Technol.* 200 (1–4), 686–689.
- Vaideki, K., Jayakumar, S., Rajendran, R., Thilagavathi, G., 2008. Investigation on the effect of RF air plasma and neem leaf extract treatment on the surface modification and antimicrobial activity of cotton fabric. *Appl. Surf. Sci.* 254 (8), 2472–2478.
- Wang, H., Lewis, D., 2002. Chemical modification of cotton to improve fibre dyeability. *Color. Technol.* 118 (4), 159–168.
- Wu, H.-L., Xu, S.-J., Jiang, S.-J., 2007. Research of flax dyeing with alkali modified. *Prog. Text. Sci. Technol.* 2, 025.
- Yeqiu, L., Jinlian, H., Yong, Z., Zhuohong, Y., 2005. Surface modification of cotton fabric by grafting of polyurethane. *Carbohydr. Polym.* 61 (3), 276–280.
- Zhang, F., Chen, Y., Lin, H., Wang, H., Zhao, B., 2008. HBP-NH₂ grafted cotton fiber: preparation and salt-free dyeing properties. *Carbohydr. Polym.* 74 (2), 250–256.
- Zhang, F., Chen, Y., Lin, H., Zhang, D., 2008. Performance of cotton fabric treated with an amino-terminated hyperbranched polymer. *Fibers Polym.* 9 (5), 515–520.
- Zhang, Q.Y., Liu, Z.D., Zhang, Y., Xu, L.B., 2014. The difficulties of dyeing of flax fiber and the improving method. *Adv. Mater. Res.* 450–453. *Trans Tech Publ.*

This page intentionally left blank

Natural fibre composites (NFCs) for construction and automotive industries

14

Yong K. Kim, Vijaya Chalivendra

University of Massachusetts Dartmouth, North Dartmouth, MA, United States

14.1 Introduction

Natural fibre composites (NFCs) are composite materials, in which at least the reinforcing fibres are derived from renewable and carbon dioxide neutral resources such as wood or plants. NFCs are used in moulded articles that require moderate strength for acceptable performance such as equipment housings, roofing for low-cost housing and in large diameter piping (Alves et al., 2010).

Impetus for using composite materials for automobile industry stems from the proactive effort by reducing the weight of manufactured cars and trucks to reduce the environmental burden in the total life cycle of the automobiles including development, production, use, disposal, and recycling would be strongly required. According to Martin Goede et al. (2009), a mass reduction of 100-kg in a car weight could result in a 0.3–0.5 L/100 km fuel consumption reduction and a 7.5–12.5 g/km carbon dioxide emission decrease. A study on Audi car door panels showed that replacing traditional ABS panels with hemp/epoxy NFC composite material lowered net energy consumption by 45% and significantly reduced overall CO₂ and methane emissions (Joshia et al., 2004). Thus, the industry stakeholders are required to embrace the reduced global carbon dioxide emissions and establishment of a sustainable society. Recently automotive and packaging industries are demanding a shift of their design from oil-derived polymers and mineral reinforcement materials to natural materials to exploit the recyclability and/or biodegradability of ‘green’ products at the end of life. This shift of material selection and design changes was predicted from the fact that drastic reduction in worldwide reserves of petroleum has increased the price of petroleum considerably; also, disposal costs of petroleum-based composites are very high and some composites are impossible to dispose of, whereas natural materials are renewable, inexpensive, biodegradable and environmentally friendly. European directives (e.g. European Parliament and the Council, 2000) also play an important role as a driving force towards sustainable mobility. For instance, the directive European Parliament and the Council (2000) related to end of life vehicles, predetermines the deposition fraction of a vehicle to 15% in 2005, and then gradually reduces it to 5% in 2015.

Over the last 2 decades, increasing numbers of car models, first in Europe encouraged by government legislation and then in North America, have adopted natural

fibre-reinforced polymers in door panels, package trays, hat racks, instruments panels, internal engine covers, sun visors, boot liners, oil/air filters progressing to more structurally demanding components such as seat backs and exterior underfloor panelling. Recently, all of the major international automotive manufacturers use these materials and their use is expected to increase in this area (Faruk et al., 2014).

In the construction industry, wood fibre/PP or fibre/PE has been used extensively in decking, particularly in the United States. Natural fibre-reinforced composites have also been gaining popularity in non-structural construction applications and used for door and window frames, wall insulation, and floor lamination (Corradi et al., 2009, Kymäläinen and Sjöberg, 2008). Assessment for replacement of wooden laminates in insulating structural panels has found NFCs to have better mechanical properties (Uddin and Kalyankar, 2011). Reinforcement of cement by natural fibres for building materials is also being assessed (Uddin and Kalyankar, 2011).

Overall, the global NFCs market was estimated at US \$2.1 billion in 2010 and projected to rise 10% annually until 2016 reflecting further potential seen across a range of industries including automotive, aerospace, construction, civil and the sports and leisure industries (Ho et al., 2012).

In this context, construction, furniture, packaging and automotive industries are exploring opportunities to replace traditional materials such as metals, polymeric resins and reinforcement fibres synthesized from petroleum oils with newly emerging NFCs to save energy cost and reduce environmental impacts. Traditionally, natural fibres are often applied only for markets that require low costs and high production rates and can accept low performance. Recently, natural fibres are emerging as reinforcement fibres for composite materials in automotive, furniture, packaging and building industries. The main reason for the trend is that natural fibres have many advantages over glass fibres, which are typically used as reinforcement fibres in these industries. While their major advantages are lower cost, lightweight resulting composites, biodegradability and renewable sources, natural fibres have disadvantages such as variations in fibre geometry and physical properties, lower mechanical properties, poor interfacial adhesion and incompatibility with hydrophobic matrix resin systems (Kozłowski et al., 2005; Netravali, 2005).

Thus, the main focus of NFC researchers has been and will be to overcome these drawbacks for design, and manufacturing reasonably performing natural fibre-reinforced composites for automotive, construction and other applications. These natural fibres possess good tensile properties comparable to glass fibres, and mostly are processed with traditional textile equipment with lower energy requirement.

Composite materials can be defined as all solid materials composed of more than one component, where these components are in separate phases (Strong, 2008). This wide definition includes materials such as fibre-reinforced plastics, common and steel reinforced concrete, particle filled plastics, rubber toughened plastics, ceramic mixtures, etc. However, we are interested in fibre-reinforced polymeric composites, which are composed of reinforcement fibres that are held by surrounding resin matrix. The reinforcement fibres may be in the form of continuous filaments or short fibres. The fibres are converted to suitable reinforcement preforms such as nonwoven mats, yarns, fabrics and 3D fabrics.

This chapter focuses on NFCs in which the matrix materials are polymeric resins. NFCs are composite materials comprising at least one major component derived from a biological origin. The natural fibres can be used as the reinforcement, such as long textile fibres (e.g. flax, hemp, kenaf, jute, ramie and sisal), short fibres (wood fibres, by-products from long fibre processing, and recycled fibres) and fibre fibrils (Miao and Finn, 2008). The matrix materials can be derived from biomaterials such as various epoxidized plant oils and soy protein (Wool and Sun, 2005). Most of the biopolymers are still in the development stage. The vast majority of current NFCs are made from a combination of natural fibres and polymeric matrices derived from bioplastics, which can replace the traditional matrix resins from petrochemicals (European Bioplastics, 2019-1, 2019-2).

NFCs can be fabricated with manufacturing methods that are used for conventional composites of thermoset matrix and thermoplastic composites. These traditional composite fabrication methods include resin transfer moulding (RTM), vacuum infusion, compression moulding, direct extrusion and compounding, and injection moulding. Different manufacturing techniques as well as different constituents result in composite materials with diverse properties. The properties of NFCs, thus, can be tailored for various types of applications by a proper selection of fibres, matrix resins, additives and manufacturing method.

14.2 Natural fibre composites (NFCs)

Natural fibre composites are produced by combining various natural fibre preforms and matrix resins derived from natural polymers or synthetic polymers. The matrix resins are either thermosets or thermoplastics.

14.2.1 Fundamentals of composite materials

Composite materials have been used for a long time, but it was not until the 1960s that the introduction of polymeric composite materials based on advanced fibres began to capture the attention of industries. With the availability of an established design database for the last 50 years, composite materials have become common engineering materials and are utilized in various applications including automotive components, infrastructures, aerospace parts, sporting goods, wind turbine blades, marine and oil industries. By replacing steel components with composite ones, a weight saving of 60%–80% is realizable (Mazumdar, 2002).

Typically composite materials are formed by combining reinforcements in a matrix material system. Reinforcements can be in the form of fibres, particles or whiskers made of metals, ceramics and polymers (Fig. 14.1). Mostly used reinforcements are in fibre form. Reinforcement fibre usually has much greater mechanical properties and serves as the principal load-carrying member. The efficacy of reinforcing fibres is determined by interface, aspect ratio, fibre placement geometry in terms of distribution and orientation. Matrix materials can be made of metals, polymers or ceramics.

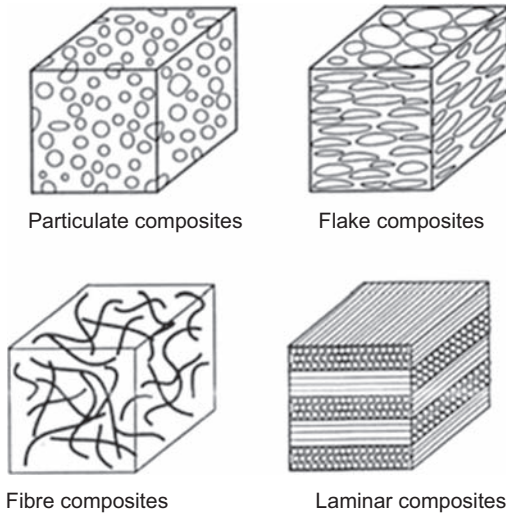

Figure 14.1 Composite materials of various reinforcement geometries.

The matrix plays the role of a binder to keep the fibres or other types of reinforcement in a desired location and orientation. The matrix transfers load to the reinforcement through the fibre–matrix interface, and it protects reinforcement from environmental damage. The reinforcement–matrix interface plays a decisive role in the transferring load from the matrix to the fibre.

Polymer composites are divided into two groups by matrix resin type, thermosets and thermoplastics. Then they are further divided into two groups by the performance requirements, engineering composites and advanced composites (Strong, 2008). Advanced composites are generally fabricated with continuous high-performance fibre reinforcements and matrix resins with superior thermal and mechanical properties. For thermosets, resins used for engineering composites are typically polyesters and vinyl esters. The engineering thermoset composites (ETSCs) are alternatively called fibreglass-reinforced plastics (FRP), since the reinforcement for ETSC is almost always glass fibres. Generally for ETSCs, fibre placement during the moulding is often random in such processes as spray-up and wet lay-up with short fibres, even when more precise fibre placement techniques such as filament winding, pultrusion and RTM, resin/fibre content control are less precise than would be the case for the same processes used with advanced thermoset composites (ATSC).

The most important organic polymer engineering composites (OPECs) are FRP which are used in applications such as automotive, construction, consumer goods, and marine and infrastructure components. Typical OPECs are listed in Table 14.1.

The characteristics of engineering composites and advanced (high performance) composites are compared in Table 14.2. The ATSCs are differentiated from ETSCs by the types of resins, reinforcements and precision of the processes used to control fibre placement (Strong, 2008).

Table 14.1 Organic polymer engineering composites.

Classification	Typical example(s)
Fibre/resin composites	Glass fabric/mat reinforced
Continuous	Polyester resin moulded into
Discontinuous	Sport boat hulls.
Heterophase polymer mixtures	Aluminium and/or graphite
Random particulate filled	Powder blended into nylon
Flake or shaped particles	Plastic to form a machine gear.
Interstitial polymeric materials	'Marbleized' decorative
Interpenetrating polymer networks skeletal composites	Plastic for wall panels.
Laminar and linear composites	High pressure laminates used
Material hybrids	In kitchen counter top.
Polymer-polymer	Polyurethane rubber impregnated Polyaramid rope/cable

Table 14.2 Comparison of engineering and advanced composites.

	Engineering composites		Advanced composites	
	Thermosets	Thermoplastics	Thermosets	Thermoplastics
Resin	Low cost (polyester, vinyl ester)	Low cost (PP, PC, nylon, PET, ABS)	Epoxies & speciality (phenolics, PUR, polyimides, silicones)	High aromatic resins (PEEK, PPS, PAS, liquid crystal polymers, TPimides)
Reinforcement	Chopped or woven fibreglass	Short fibreglass	Advanced long fibres (carbon, aramids etc.)	High-performance long fibres
Fibre content	Up to 50%	Up to 40%	50%–65%	50%–65%
Processing	Traditional thermoset curing (spray-up, lay-up, RTM, pultrusion, filament winding)	Traditional thermoplastic processing (injection moulding, extrusion, blow moulding)	Precision placement methods (prepreg lay-up, filament winding, pultrusion, RTM)	Modified precision methods for thermosets and specific methods for thermoplastics only

Engineering thermoplastic composites (ETPC) are fabricated from relatively low-cost commodity thermoplastics such as polypropylene (PP), nylon, polycarbonate (PC), polyethylene terephthalate (PET) and acrylonitrile butadiene styrene (ABS). These traditional thermoplastic resins are now replaced by the bioplastic counterparts derived from renewable resources ([European Bioplastics, 2019-2](#)). Main reinforcements are short glass fibres, which will be replaced by natural fibres for engineering thermoplastic natural fibre composite (ETNFC) products. ETPCs are moulded using traditional thermoforming techniques such as injection moulding, extrusion and blow moulding. It is very difficult to process resin and short fibre mixtures in the thermoforming machines. This difficulty limits the maximum fibre volume up to 40%.

Advanced thermoplastic composites (ATPC) are produced using long high-performance fibres (carbon, aramid, ceramic yarns) with high thermomechanical resins such as polyetheretherketone (PEEK), polyphenylene sulfide (PPS), polyarylsulfone (PAS) and thermoplastic imides (TPIs). The precision fibre placement methods adopted from thermoset processing or specialized thermoplastic processing techniques enable the reinforcement fibre volume in high content, typically more than 50% up to 65%.

In summary, NFCs can replace the traditional application areas of ETSC and ETPC by choosing the proper natural reinforcement type and matrix resin system. [Joshia et al. \(2004\)](#) concluded that NFCs are likely to be environmentally superior to FRP in most applications after comprehensive life-cycle analysis of these classes of composites. However, they warned that the environmental quality improvement will disappear for the case of increased fertilizer use in natural fibre cultivation, which results in higher nitrate and phosphate emissions causing water quality deterioration of local water-bodies. Furthermore, the environmental superiority of NFCs may vanish if NFC products have significantly lower operating life compared to FRP components. Thus, NFC research should focus on achieving equivalent or superior technical performance and component life.

14.2.2 Matrix resins systems for NFCs

According to the European Bioplastics in cooperation with the research institute Nova-Institute, global bioplastics production capacity is set to increase from around 2.11 million tons in 2018 to approximately 2.62 million tons in 2023 ([European Bioplastics, 2019-1](#)). Innovative biopolymers such as PLA (polylactic acid) and PHAs (polyhydroxyalkanoates) are the main reasons for this growth in the field of bio-based, biodegradable plastics. PHAs are an important polymer family that has been in development stage for a while, and recently finally enters the market at commercial scale, with production capacities estimated to quadruple in the next 5 years.

These polyesters are completely bio-based, biodegradable, and supplied with a wide array of physical and mechanical properties depending on their chemical composition production processes. Production capacities of PLA are also predicted to grow by 60% by 2023 compared to 2018. PLA is a very versatile material that features excellent barrier properties and is available in high-performance PLA grades that are an excellent replacement for PS (polystyrene), PP (polypropylene), and ABS (acrylonitrile butadiene styrene) in more demanding applications.

Table 14.3 Unfilled thermosetting resin properties.

Resin	Density (g/cm ³)	Tensile modulus (GPa)	Tensile strength (MPa)
Epoxy ^a	1.2–1.4	2.5–5.0	50–110
Phenolic ^a	1.2–1.4	2.7–4.1	35–60
Polyester ^a	1.1–1.4	1.6–4.1	35–95
AESO/ Styrene ^b	1.0–1.2	1.0–1.6	15–21

^aafter Mazumdar (2002).

^bAESO (80–60 wt%) after Wool and Sun (2005).

Bio-based, non-biodegradable plastics, including the drop-in solutions bio-based PE (polyethylene) and bio-based PET (polyethylene terephthalate), as well as bio-based PA (polyamides), currently make up for around 48% (1 million tons) of the global bioplastics production capacities. The production of bio-based PE is predicted to continue to grow as new capacities are planned to come online in Europe in the coming years. Bio-based PP is expected to enter the market on a commercial scale with a strong growth potential due to the widespread application of PP in a potential structural recyclable NFC applications. Bio-based PUR (polyurethanes) are another important group of polymers that have huge production capacities with a well-established market and are expected to grow faster than the conventional PUR market due to their versatility (European Bioplastics, 2019-1, 2019-2).

Polymeric matrix resins can be classified into two types: thermoplastics and thermosets. Thermoplastics are polymers in which cross-links (bonds between molecules) are not present; polymers in which cross-links are present are called thermosets. Thermoset materials once cured cannot be re-melted or reformed. During the curing they form three-dimensional molecular networks called cross-links. These cross-linked bonds are as strong as the polymeric backbone chains. Due to these cross-links, thermoset molecules are not flexible and cannot be re-melted and re-shaped. In thermoset matrix composites, the fibres are impregnated with thermosetting resins and then exposed to high temperatures for curing. In fibre-reinforced polymeric composites, the most common thermoset resins are epoxy, (unsaturated) polyester, vinyl ester, phenolics, polyimide and polyurethane. Recently NFCs were fabricated with bio-based thermosetting resins from plant oils such as soybean triglycerides (Petrovic et al., 2004). O'Donnell et al. (2004) used acrylated epoxidized soybean oil (AESO), which was commercially available. Natural fibre/AESO composites are truly bio-based green composites. Some of the basic properties of selected thermosetting resins are shown in Table 14.3.

Thermoplastic materials used for ETPCs are ductile and tougher than thermosets and are widely used for non-structural applications without fillers and reinforcements. These low-cost commodity types of thermoplastic resins are nylon, PP, polystyrene (PS), polyethylene (PE), PET and polyvinyl chloride (PVC). Puglia et al. (2004) compiled a vast variety of NFCs, which were fabricated with thermoplastic matrices. European Bioplastic (2019-1) reports that all of these bio-based thermoplastic matrix

resins such as PE, PP, PVC, PLA, PET, PHA and polyamide with performance property comparable or exceeding to non-bio-based counterparts are commercially available to substitute (European Bioplastics, 2019-2).

One of the main advantages of thermoplastic NFC is the possibility of using the conventional thermoplastic processing equipment with low maintenance costs as a consequence of the poor abrasion resistance of natural fibres. However, the major processing problems associated with the natural fibre-filled thermoplastic systems stem from variation in the quality of the natural fibre material, incompatibility between the hydrophilic natural fibre and the hydrophobic matrix and the poor thermal stability of these lignocellulosic fibres at temperatures above 230°C.

Sain and Panthapulakkal (2005) listed PP, PS, PE (low-density polyethylene [LDPE]) as well as high-density polyethylene [HDPE]), PVC and polyamide 6 and 6,6 as viable thermoplastic resins for NFCs within the thermal stability limits of lignocellulosic natural fibres. Since less damage is done to the processing equipment by the less abrasive natural fibres compared to glass fibres, a higher fibre loading about 50–65 wt.% can be processed compared to that of glass fibres (40%). The final properties of the composite are strongly correlated to a number of parameters such as the mechanical properties and the geometrical characteristics of the reinforcement fibres, the fibre–matrix and the fibre–fibre interactions and the distribution and orientation of fibres. Currently, for automotive applications most common NFCs are components made of lignocellulosic fibre with PP as matrix material.

However, thermoplastic matrix materials derived from renewable raw materials available in last 2 decades are not popular due to the high cost, poor processability and poor performance properties. Starch has many application potentials as thermoplastics in disposable items and packaging materials, but starch is brittle and hydrophilic. Moreover starch has poor flowability in extrusion and moulding processes (Wool and Sun, 2005). Starch or modified starch is not used for matrix resin material for NFCs.

These drawbacks are now overcome by the bioplastic development and commercial scale availability of equivalent mechanical and physical properties to conventional resins. There are many different thermoplastic polymers of renewable materials (see Fig. 14.2): polylactic acid (PLA), polyhydroxybutyrate (PHB), and cellulose esters. Bioplastics – polymeric materials that are bio-based, biodegradable, or both – have the same properties as conventional plastics and offer additional advantages, such as a reduced carbon footprint or additional waste management options such as composting. Bioplastics are a diverse family of materials with differing properties. There are three main groups (European Bioplastics, 2019-2):

- bio-based or partially bio-based non-biodegradable plastics such as bio-based PE, PP, or PET (so-called drop-ins) and bio-based technical performance polymers such as PTT or TPC-ET (thermoplastic polyester elastomers);
- Plastics that are both bio-based and biodegradable, such as PLA and PHA or PBS (polybutylene succinate);
- Plastics that are based on fossil resources and are biodegradable, such as PBAT (polybutylene adipate terephthalate).

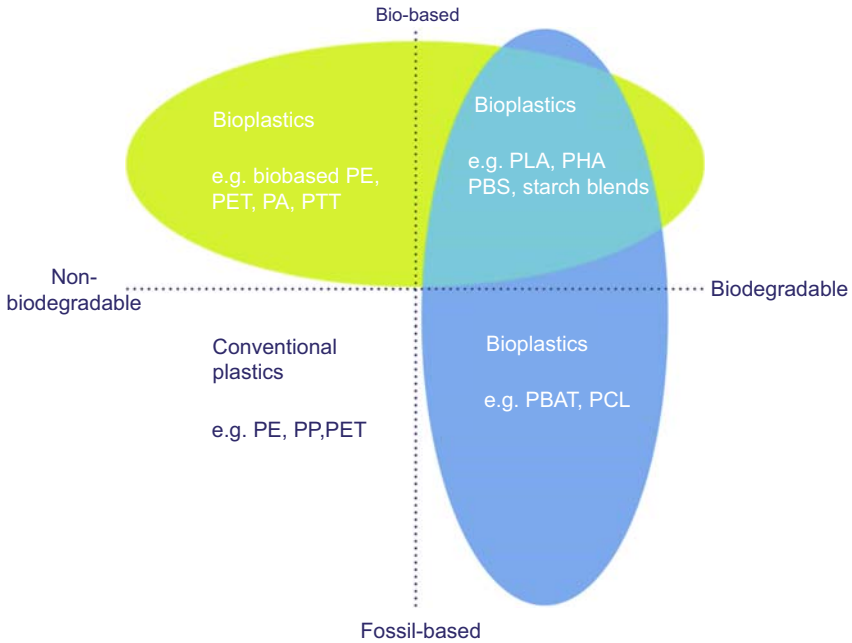

Figure 14.2 Thermoplastics derived from renewable sources (European Bioplastics, 2019-2).

Oksman et al. (2003) studied flax/PLA NFC and reported that the strength of composite is about 50% better compared to similar flax/PP composites, which are commonly used in many industrial applications including automobiles. They concluded that PLA can replace PP as a matrix resin, since the stiffness of PLA composite is 8.4 GPa with a 30 wt.% flax fibre content. However, here the cost and commercial availability of the PLA should be considered over the commodity status of PP plastics.

14.3 Natural fibre reinforcement forms for green composites

Natural fibres used for NFC reinforcements are long textile fibres such as flax, hemp, kenaf, jute, ramie and sisal, short fibre by-products from these long fibre processing, wood fibres, recycled fibres, etc. (Kozłowski and Waldyka-Przybylak, 2004). Natural fibres such as flax, ramie and hemp can be used for replacement of glass fibres as non-structural composite replacements in automotive components and building material applications. Production and converting these bast fibres for suitable textile and reinforcement forms are reviewed by Biagiotti et al. (2004).

They pointed out that these fibres have comparable tensile strength and specific modulus with E-glass fibres as shown in Table 14.4. However, as the properties of these natural fibres depend largely on cultivars, the regions where they are produced, processing methods and produced fibre geometry, it is difficult to obtain reproducible

Table 14.4 Physical properties comparison of selected natural fibres with typical advanced reinforcement fibres for engineering composites.

Fibre	Density (g/cm ³)	Elongation at break (%)	Tensile strength (MPa)	Young's modulus (GPa)	Specific modulus (GPa cm ³ /g)
Flax	1.40–1.50	2.7–3.2	343–1035	27–80	19–53
Jute	1.30–1.50	1.4–3.1	187–773	3–55	2–37
Ramie	1.50	3.6–3.8	400–938	44–128	29–85
Hemp	1.40–1.50	1.4–4.7	580–1110	3–90	2–60
Abaca	1.50	10–12	980	72	48
E-glass	2.50–2.55	2.5	2000–3500	73.0	29
Aramid	1.40–1.45	3.3–3.7	3000–3150	63.0–67.0	45–48
Carbon	1.40–1.75	1.4–1.8	4000	230–500	164–171

After Biagiotti, J., Puglia, D., Kenny, J.M., 2004. A review on natural fibre-based composites. Part I: structure, processing and properties of vegetable fibres. *J. Nat. Fibers* 1 (2), 37–68.

results and properties of composites. Thus, the reinforcement material selection stages of NFC product design and development are increasingly more complex than that of high-performance fibre such as E-glass.

Textile reinforcement forms are classified according to dimension and the number of yarn-axis (Schwartz, 1997). Natural fibres are supplied in forms of short staple fibres to long fibre bundles. These natural fibres can be converted into preform shapes of fibre mat (non-axial 2D arrangement), long fibre roving/sliver, and twisted yarn (monoaxial 1D arrangement) by typical textile processing techniques. Further, the twisted yarns can be made into unidirectional pre-impregnation sheets (monoaxial 2D arrangement), various woven structures (biaxial 2D arrangement), triaxial and multiaxial weave or knit structures (multi-axial 2D arrangement). For advanced composite preforms with high preforms fibres such as glass, carbon and para-aramids, complex near net-shape preforms are available in 3D braid (monoaxial 3D arrangement), 3D bi-/tri-/multi-axial weave formats. Among the natural fibre reinforcement forms, fibre mats and woven fabrics are mostly used.

Most engineering polymer matrix composites from plant fibres are made of short fibre nonwoven preforms. Natural fibres from plant origins are processed to form nonwoven mats. Typical nonwoven web formation processing equipment is utilized to fabricate fibre mat preforms in parallel-laid, cross-laid, random-laid (or air-laid) webs. The resulting bulky nonwoven webs are consolidated by needle punching for easy handling and desired porosity. When the fibre webs contain thermoplastic fibres, these can be consolidated by thermal bonding.

Mechanical properties of short fibre composites based on fibre mats are mostly determined by the fibre volume fraction, fibre length and the fibre orientation

distribution (Aziz and Ansell, 2005). The composite fibre property (Pc) can be expressed as the ‘Rule of Mixtures’ model:

$$P_c = \eta_o \eta_l v_f P_f + v_m P_m \tag{14.1}$$

where η_o = fibre orientation factor, η_l = fibre length factor, v_f, P_f = volume fraction and property of fibre and v_m, P_m = volume fraction and property of matrix material and P can be Young’s modulus (E) or strength (σ).

Fibre volume fraction (v_f) is the single most significant factor to be considered in composite property estimation due to the fact that reinforcement fibres contribute mostly to the resulting composite mechanical properties. Thus mechanical properties of NFCs increase with v_f . However, there is a maximum v_f achievable, which is largely governed by the fibre orientation distribution and fibre placement. Point out that the maximum fibre fraction achievable with randomly orientated short fibre assemblies (nonwoven mats) was about 40%, while parallel fibre assemblies such as staple fibre rovings and yarns could achieve fibre volume fractions of about 60%.

Fibre orientation also determines the effective utilization of fibre mechanical properties in a composite. To derive the orientation factor η_o , let us consider a fibre mat made of fibres fully oriented in the machine direction (MD). If transverse modulus is neglected, the mat modulus in angle θ_n (E') from the MD is given as:

$$E' = E_f \cos^4 \theta_n \tag{14.2}$$

For orthotropic fibre mat with fibre orientation distribution $f(\theta_n)$, effective modulus in the MD (E_L) is given as:

$$E_L = \eta_o E_f = \Sigma E_f f(\theta_n) \cos^4 \theta_n \tag{14.3}$$

From Eq. (14.3), the fibre orientation factor η_o is given by:

$$\eta_o = \Sigma f(\theta_n) \cos^4 \theta_n \tag{14.4}$$

where $f(\theta_n)$ is the fraction of fibres with orientation angle θ_n .

For a 2D fibre mat with random orientation of fibres, it can be shown that $\eta_o = 3/8$ by integrating Eq. (14.4) with $f(\theta) = 1/\pi$. Piggott (2008) showed that $\eta_o = 1/5$ for composites having fibres which are random in three dimensions.

The reinforcement efficacy of short fibres (η_1) is further reduced from that of unidirectional long fibre composites. Piggott (2008) showed that for moderately long fibres,

$$\eta_1 = 1 - 1/ns \tag{14.5}$$

where $n^2 = 2E_m / \{E_f(1 + v_m) \ln(\varphi_f/v_f)\}$, φ_f is fibre packing factor, and $s = L_f/D_f$ (fibre aspect ratio). For $\eta_s \geq 20$, $\eta_1 \approx 0.95$, which means that the short fibre composite modulus will be within 95% of the continuous unidirectional fibre composites.

Yarn-based preforms such as unidirectional and bidirectional fabrics provide better mechanical performance properties of the resulting composites. Fibre placement in the yarn structures and yarn forming method can influence the strength utilization factor. For example, fibres are arranged in twisted yarn structures, the staple yarn strength is reduced from the untwisted fibre strength by the factor of \cos^2 (twist angle), which is 50% reduction from untwisted fibre strength for a yarn with outer twist angle of 45 degrees. Thus a wrap yarn from plant fibres has advantage. Miao and Finn (2008) reported that the strength and modulus of wrap yarn are 200 MPa and 18 GPa, respectively, while those of highly twisted yarn are 110 MPa and 12 GPa, respectively. However, the strength contribution of yarns in composite structures depends mainly on fibre orientation and interfacial adhesion, and does not come from the inter-fibre friction in twisted yarn structure.

Yarn structures derived from the plant fibres can be converted into 2D reinforcements such as unidirectional fabrics and regular biaxial fabrics. These fabric preforms can be incorporated into a matrix resin system to fabricate laminar composites for various products. These yarns can be processed into 3D woven, knitted and braided structures. However, 3D preforms have disadvantages of higher cost and potential poor parent yarn strength utilization factor.

When mechanical strength of the composites is not critical, but conformability to mould surface, preferred preforms are knitted fabric structures. A knitted fabric is formed by intermeshing of loops opposed to interlacing of orthogonal two sets of yarns in woven structures. Inter-meshed loops provide better drapability.

14.4 NFC manufacturing methods

Composites are manufactured by four basic steps: impregnation, lay-up, consolidation and solidification. All composite fabrication involves the same four basic steps, while different processing techniques accomplish them in different manners. In general, polymeric matrix composite fabrication techniques are further divided by the reinforcements and matrix resin systems. Table 14.5 shows the classification of the composite manufacturing methods adopted in various industrial applications. Typical NFC products developed for automotive and construction industry are engineering polymer composites, which require high production rate, but less mechanical strength than their advanced composites counterpart.

Fabrication processes for incorporating preforms into a matrix resin are further divided into two groups. In the first group, called reactive processing, matrix and preforms of continuous and/or short fibres are processed directly into the finished composite structures. Examples of this group are structural reaction injection moulding (SRIM), spray-up, filament winding and RTM, to name a few. The second group requires the intermediate process of forming ready-to-mould sheets by incorporating reinforcements into matrix resin systems. These ready-to-mould sheets are available in prepregs and sheet moulding compounds (SMC), which can be stored and later processed to fabricate laminar composites by autoclave and compression moulding (Schwartz, 1997).

Table 14.5 Composite processing techniques.

Resin system	Reinforcement type	Processing technique
Thermoset composites	Short fiber	SMC moulding, SRIM, BMC moulding, spray-up, injection moulding
	Continuous filament	Filament winding, pultrusion, RTM, VARTM, hand lay-up, autoclave, roll wrapping, SCRIMP, bladder moulding
Thermoplastic composites	Short fiber	Injection moulding, blow moulding
	Continuous filament	Thermoforming, tape winding, compression moulding, autoclave, diaphragm forming

After Mazumdar, S.K., 2002. *Composites Manufacturing: Materials, Products, and Process Engineering*. CRC Press, Boca Raton, FL; Schwartz, M.M., 1997. *Composite Materials*, vol. 2. Prentice Hall, Upper Saddle River, NJ.

Manufacturing process for a production of component is selected based on production rate, cost performance, size and shape of the product. The various processes characteristics are compared in Table 14.6 (Hancox and Mayer, 1994; Mazumdar, 2002).

RTM and SRIM are two similar liquid composite moulding (LCM) processes, which are well adaptable to the manufacture of small-to-medium, complex, light-weight, and high-performance composite components primarily for aerospace and automotive industries. Both of the RTM and SRIM processes can utilize a wide variety of preforms such as woven, nonwoven, knitted and various 3D fibre assemblies. The resins used in RTM are thermally activated, whereas resins used in SRIM process are mixing activated. In the RTM process, a static mixer is used for resin mixture at about a 100 to 1 ratio as depicted in Fig. 14.3. At the filling temperature, thermally activated resins react very slowly, therefore it takes up to 15 min of filling time, and cycle time for RTM is in the order of an hour. RTM is limited to a low volume production (<10,000 parts) due to the long cycle time. And soft mould made of composites or aluminium, whereas SRIM is suitable for medium-to-high-volume (10,000–100,000 parts) application due to fast reaction and cycle time using steel moulds (Osswald et al., 2006).

Thus, high-quality NFC components with thermoset matrices can be manufactured using manufacturing techniques such as hand lay-up, modified lay-up/press moulding, pultrusion, vacuum-assisted resin infusion, SRIM and RTM. These processes can be implemented with existing presently available equipment without new investment, which could have been necessary for natural fibres. However, an optimization study of process variables for these fabrication technologies for natural fibre reinforcements is required, since the existing equipment and processes are used for manufactured fibre preforms. It is conceivable that cost-effective high-quality NFC parts can be fabricated by compression moulding from SMC and bulk moulding compound (BMC) with natural fibres.

Table 14.6 The characteristics of various composite manufacturing methods.

Process	Production speed	Cost	Strength	Size	Shape	Raw material
Filament winding	Slow—fast	Low—high	High	Small—large	Axisymmetric cylindrical	Continuous filament, epoxy and polyester resins
Pultrusion	Fast	Low—medium	High in length direction	No length limit, cross-section small to medium	Uniform cross-section	Continuous filament, epoxy and polyester resins
Hand lay-up	Slow	High	High	Small—large	Simple—complex	Prepreg or fabric with epoxy
Wet lay-up	Slow	Medium	Medium—high	Medium—large	Simple—complex	Fabric/mat with polyester, epoxy
Spray-up	Medium—fast	Low	Low	Small—medium	Simple—complex	Short fibre with catalyzed resin
RTM, VARTM	Medium	Low—medium	Medium	Small—medium	Simple—complex	Preform and fabric with vinylester and epoxy
SRIM	Fast	Low	Medium	Small—medium	Simple—complex	Fabric or perform with polyurethane, polyester, polyurea, polyisocyanurate resin
Compression Moulding	Fast	Low	Medium	Small—medium	Simple—omplex	Moulding compound (SMC, BMC), GFT, LFT
Stamping	Fast	Medium	Medium	Medium	Simple—contoured	Fabric impregnated with thermoplastic (tape)
Injection moulding	Fast	Low	Low—medium	Small	Complex	Pellets (short fibre with thermoplastic)
Roll wrapping	Medium—fast	Low—medium	High	Small—medium	Tubular	Prepregs

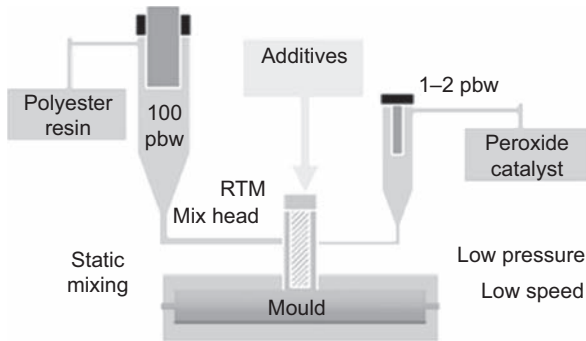

Figure 14.3 A schematic of resin transfer molding (RTM) machine (courtesy of Osborne Industries).

The most widely used technique for forming thermoplastic NFC is hot press moulding, which is a variation of glass mat/thermoplastic (GMT) compression moulding. Reinforcements of natural fibres are nonwoven mats. Typical applications of natural fibre nonwoven mat reinforced thermoplastics are interior components for the automotive industry. The maleic anhydride-modified polypropylene (MAPP) is used as matrix resin to promote adhesion strength to natural fibres. The MAPP matrix resin is combined with either blending of PP fibres into the nonwoven preform, or alternately stacking the fibre preforms with MAPP films. The preform/resin stacking is press bonded at about 180°C briefly to prevent fibre damage from long residence time in the hot mould cavity.

Rotational moulding is a very effective moulding method that allows manufacturers not only to produce extremely durable products with minimum design constraints, but also produce them at comparatively low costs in an environment-friendly manner compare to other composite manufacturing techniques. Furthermore large products can be easily manufactured in an economic manner with very little material wasted. A common used plastic is polyethylene (PE), as it is able to withstand elevated temperatures for prolonged periods of time and is fairly inexpensive. Furthermore, low density PE is very flexible and resistant to fracturing. Other thermoplastic polymers used for rotomoulding are: nylon plastisols, polycarbonate, elastomers, ethylene vinyl acetate, polyurethane, polyvinyl chloride, and polypropylene. However polypropylene is not preferred by the moulders due to brittleness at room temperature and very narrow processing-time window (AZO Materials, 2019).

The moulds themselves are generally made from cast aluminium, CNC machined aluminium, or steel, and can be relatively cheap when compared to moulds used in other methods such as injection or blow moulding. The rotational moulding process is relatively simple, but extremely versatile. Firstly, the mould cavity is loaded with a powdered polymer (which is discussed in the section below). The oven is then heated to around 300°C (572°F), as the mould rotates on two axes to evenly distribute the polymer. The basic principle is that the powder particles (normally around 150–500 µm), will fuse together to create the continuous finished product. How the product eventually turns out is crucially based on the size of the powder particles.

Finally, the mould is cooled and the product is extracted for finishing. The cycle time of a basic rotomoulding process can vary from 20 min to 1 h, depending on the size and the complexity of the product (AZO Materials, 2019).

In recent years, increasing interest was developed in rotomolded composite parts to improve mechanical properties, reduce costs, and control aesthetics in automotive and construction industrial applications. With increasing environmental awareness and process optimization requirement, more producers are looking at natural fibres, mainly lignocellulosic materials as a potential reinforcement for rotomolded NFC parts. Natural fibres have high specific strength and high specific modulus (properties per unit mass), low cost, and environmental friendliness. Nevertheless, poor fibre-matrix adhesion, lower strength (especially impact strength), and poor moisture resistance leading to fibre swelling (and dimensional stability problems) have limited large-scale production. In rotational moulding, several natural fibres have been selected, such as wood flour (hardwood and softwood), flax, agave, sisal, and maple. However, last 2 decades NFCs were manufactured by injection moulding, compressions moulding, etc., very few attempts have been made to produce these composites by rotational moulding. This is even more the case for polymers other than polyethylene (Hanana and Rodrigue, 2015).

14.5 Quality assurance and testing

Composites emerged recently as a class of engineering materials dating from the 1950s. As there is no accepted database for composites, composite testing is far more important than is the case for metals and plastics. The mechanical properties are often the most important properties because virtually all service conditions and the majority of end-use applications involve some degree of mechanical loading. Nevertheless, these properties are the least understood by most design engineers. The material selection for a variety of applications is quite often based on mechanical properties such as tensile strength, modulus, elongation and impact strength. These values are normally derived from the technical literature provided by material suppliers, material databases or handbooks (Hancox and Mayer, 1994; MILHDBK-17, 1992a,b).

In practical applications, composite materials are seldom subjected to a single-steady deformation without the presence of other adverse factors such as environment and temperature. Since the published values of the mechanical properties of plastics and composites are generated from tests conducted in a laboratory under standard test conditions, the danger of selecting and specifying a material from these values is obvious. A thorough understanding of mechanical properties, tests employed to determine such properties, and the effect of adverse conditions on mechanical properties over a long period is extremely important to predict the performance and life of the product.

14.5.1 Tensile test (ASTM D3039, EN 61, ISO 3268)

Test specimens for tensile tests are prepared in many different ways. Most often, they are either injection moulded or compression moulded. The specimens may also be prepared by machining operations from materials in sheet, plate, slab or similar form. Test

specimen dimensions vary considerably depending upon the requirements and are described in detail in the ASTM book of standards. The specimens are conditioned using standard conditioning procedures. Since the tensile properties of some plastics change rapidly with small changes in temperature, it is recommended that tests be conducted in the standard laboratory atmosphere of $23 \pm 2^\circ\text{C}$ and $50 \pm 5\%$ relative humidity. Procedure A of ASTM D618 is recommended.

The tensile strength (ultimate strength), tensile modulus (Young's or elastic modulus) and elongation (ultimate strain) are all determined from the normal tensile stress-strain test. Samples that have been prepared are tested at a constant strain rate according to ASTM D3039. For cured matrix resin or conventional industrial plastics, dog bone shape samples are prepared as described in ASTM D638. The speed of testing is the relative rate of motion of the grips or test fixtures during the test. There are basically four different testing speeds specified in the ASTM D638 Standard. The most frequently employed speed of testing is 5 mm/min (0.2 in./min). The test specimen is positioned vertically in the grips of the testing machine. The grips are tightened evenly and firmly to prevent any slippage.

Tensile modulus and elongation values are derived from a stress-strain curve. An extensometer is attached to the test specimen. The extensometer is a strain gauge type of device that magnifies the actual stretch of the specimen considerably. The simultaneous stress-strain curve is plotted on graph paper or recorded in data file, which can be imported to any plotting software. From this modulus and elongation are determined.

14.5.2 Flexural properties (ASTM D790, ISO 178)

The stress-strain behaviour of polymers/composites in flexure is of interest to design engineers. Flexural strength is the ability of the material to withstand bending forces applied perpendicular to its longitudinal axis. The stresses induced due to the flexural load are a combination of compressive and tensile stresses. Flexural properties are reported and calculated in terms of the maximum stress and strain that occur at the outside surface of the test beam. Many polymers do not break under flexure even after a large deflection that makes determination of the ultimate flexural strength impractical for many polymers. In such cases, the common practice is to report flexural yield strength when the maximum strain in the outer fibre of the specimen has reached 5%. For polymeric materials that break easily under flexural load, the specimen is deflected until a rupture occurs in the outer fibres.

There are several advantages of flexural strength tests over tensile tests. If a material is used in the form of a beam and if the service failure occurs in bending, then a flexural test is more relevant for design or specification purposes than a tensile test, which may give a strength value very different from the calculated strength of the outer fibre in the bent beam. The flexural specimen is comparatively easy to prepare without residual strain. The specimen alignment is also more difficult in tensile tests. Also, the tight clamping of the test specimens creates stress concentration points. One other advantage of the flexural test is that at small strains, the actual deformations are sufficiently large to be measured accurately.

There are two basic methods that cover the determination of flexural properties of plastics and composites: Method 1 (three-point bending) and Method 2 (four-point bending).

Method 1 is a three-point loading system utilizing centre loading on a simple supported beam. A bar of rectangular cross-section rests on two supports and is loaded by means of a loading nose midway between the supports. The maximum axial fibre stresses occur on a line under the loading nose. This method is especially useful in determining flexural properties for quality control and specification purposes.

Method 2 is a four-point loading system utilizing two load points equally spaced from their adjacent support points, with a distance between load points of one-third of the support span. In this method, the test bar rests on two supports and is loaded at two points (by means of two loading noses), each at equal distance from the adjacent support point. Method 2 is very useful in testing materials that do not fail at the point of maximum stress under a three-point loading system. The maximum axial fibre stress occurs over the area between the loading noses.

Either method can be used with the two procedures. Method 1 is designed principally for materials that break at comparatively small deflections. Method 2 is designed particularly for those materials that undergo large deflections during testing. The basic difference between the two procedures is the strain rate, method 1 being 0.01/min, and method 2 being 0.10/min. The test is initiated by applying the load to the specimen at the specified crosshead rate. The deflection is measured either by a gauge under the specimen in contact with it in the centre of the support span or by measurement of the motion of loading nose relative to the supports. A load-deflection curve is plotted if determination of flexural modulus value is desired.

14.5.3 Impact/toughness properties (ASTM D256, EN ISO 180: 2000)

Toughness is defined as the ability of material to absorb energy without rupture. [Strong \(2008\)](#) differentiated two types of toughness: equilibrium toughness and impact toughness. The former is related to the area under stress-strain curve, which is determined by a tensile test at very low strain rate (assumed equilibrium). The latter is more important when the force is suddenly applied by impact and is strongly dependent upon the ability of the material to internally deform to accommodate the impact. The Izod and Charpy tests (ASTM D256) use a pendulum-impact tester. A notched sample is mounted vertically (Izod) or laid horizontally (Charpy). To determine the toughness, the pendulum is released from highest position, strikes the specimen and breaks up the notched specimen. Then it stops at lower height indicated by the pointer than the starting height. This potential energy differential is directly proportional to the energy absorbed by the material. Another test to determine impact toughness is the falling dart test (ASTM D5628). Fracture toughness of laminar composites is determined by Mode-I Fracture toughness testing using double cantilever beam (DCB) test (ASTM D5528-13).

14.5.4 Nondestructive testing (NDT)

Most of the tests described above are destructive. Several nondestructive testing (NDT) have been developed to investigate the nature of the product, including the effectiveness of and reliability of the manufacturing process. Most NDT techniques utilize the detected changes in the energy signal through or onto the part to be inspected by comparing to some standard. NDTs include ultrasonic testing, radiography, thermography, and microwave and eddy current.

Ultrasonic testing mostly uses the NDT techniques for composites. The energy wave used in ultrasonic testing is acoustic waves (20–100 MHz), which are not electromagnetic in nature. The frequencies are just right for carbon/epoxy composites, because the wavelengths are about the same size as common defects in this type of composites. This NDT can detect size, location and depth of defects by C-scan mode.

X-ray radiography is useful for metal matrix composites and medical applications. Most polymer composites are nearly transparent to X-ray, thus, defects cannot be easily detected. X-ray is also used with precaution to avoid radiation hazard. Infrared thermography is used for detecting internal flaws. Infrared (IR) thermogram of the sample surface shows the temperature differential caused by the internal flaws. In the active mode of operation, the emitted heat is detected after the sample is subjected to mechanical stress or vibration. In the passive mode, the sample is externally heated and thermal gradient is detected. Eddy current is only applicable to conductive composites, because an eddy current is an induced current within a conductive material.

Surface defects are detected and classified by visual inspection. It is especially useful in colour determination and surface irregularity.

14.5.5 Flammability testing

Flammability of composites is mainly determined by the resin matrix, since the contributions of glass and other high-performance fibres to the fire are much smaller than the resin matrix. In general, NFCs are more flammable than advanced composites, as natural fibres are far more flammable than glass or carbon fibres with the same matrix resin. The burning of composites and plastics is characterized by the following properties: ease of ignition, flame spread, heat release rate, ease of extinguish, smoke emission/toxicity and burning characteristics. [Strong \(2008\)](#) pointed out that the purpose of flammability testing can be divided into three groups: official tests for official requirements, laboratory tests for product development/improvement, and full scale tests for simulating actual use condition.

Official tests are mandated by various market sectors. The most important official test is the cone calorimeter (ISO 5660/ASTM E1354), which provide most of the fundamental combustion characteristics (ease of ignition, heat release rate, weight of sample as it burns, temperature of sample as it burns, rate of weight loss, rate of smoke release, and yield of smoke) under a wide range of heat and ignition conditions. This vast amount of data can be used to develop a combustion model of the composite material. Other official flammability tests are flame spread index (ASTM E162) by

radiant heat panel test, and the smoke density generating rate under both flaming and smouldering condition (ASTM E662) by smoke chamber test. For example, automotive seats, panels, walls, partitions and ceiling made of composites are tested with ASTM E162 and ASTM E662.

Laboratory tests are used to adjust formula or product design, when the official tests are not feasible in terms of cost and time. However, laboratory tests are not suitable for ranking the combustion characteristics of widely different materials. The most common laboratory tests are the limiting oxygen index (LOI) test (ASTM D2863), the vertical burn test (ASTM D568 and D3801) and the horizontal burn test (ASTM D635). The LOI test is the most accurate lab test, which determines the minimum oxygen content required to sustain burning. Higher LOI index is associated with decreased flammability.

Full scale tests are used to determine the performance under actual combustion situation, which may be speculated based on the results from the official and/or laboratory tests. Flammability research will play an important role in new product development and improving existing products to meet many agencies' goals of protecting the public and limiting the liability through testing.

14.6 NFCs for building and automotive industries

In this section, NFC applications in building materials and automotive parts are discussed.

14.6.1 *Green composites for building materials*

Bio-based structural composites for housing and infrastructure applications are newly emerging materials that will play important role in next-generation building materials not only for the US housing industry but also for Europe and the whole world in the 21st century.

According to the Partnership for Advancing Technology in Housing (PATH), currently available building materials based on polymer matrix composites are FRP decking, recycled wood/plastic composites, structural insulated panels (SIPs), panelized wall and loop systems, composite window frames, and plastic trim products. Reinforcement fibres used in these commercially supplied products are glass fibres and wood fibres. For example, composite deckings and window frames are manufactured glass fibre-reinforced unsaturated polyester and PVC matrices. With optimized design and improving interface adhesion, NFCs can be competitive alternatives in FRP decking and composite window frames.

Brzyski et al. (2017) studied systematically NFCs for energy efficient building construction using flax/hemp wastes as a filling material of lime-based composites. They showed that the composite exhibits low strength, low density, low thermal conductivity, and high absorptivity. The external walls made of the lime—flax—hemp composite receive a limited exposure to condensation, but not significant enough to constitute any threat. The studied lime-flax-hemp composites can meet the requirements established

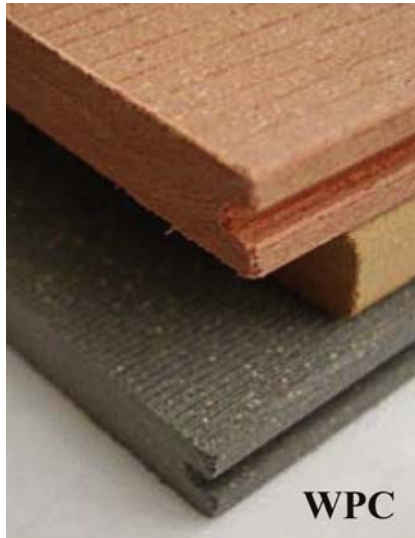

Figure 14.4 Decking produced from wood/plastic composites (Courtesy of Dr. Anil Netravali).

for low-energy buildings. Hempcrete or Hemplime is commercially available hemp/lime NFC, which is a mixture of hemp hurds (shives) and lime used as a material for construction and insulation. Hempcrete is easier to work with than traditional lime mixes and acts as an insulator and moisture regulator. It lacks the brittleness of concrete and consequently does not need expansion joints (Wikipedia, 2019). Hempcrete has been used in France since the early 1990s to construct non-weight bearing insulating infill walls.

Recycled wood/plastic composite (WPC) lumber typically consists of a 50/50 mix of wood fibres from recovered sawdust and waste plastics that include high-density PE, PVC and others (Fig. 14.4).

The WPCs are used to produce building products such as decking, door and window frames, and exterior mouldings. The material is formed into both solid and hollow profiles. Some recycled wood/plastic lumber products can weigh considerably more than standard lumber products. Like other plastic products, recycled wood/plastic lumber can become more flexible in hot weather and more rigid in cold weather than other decking materials. However, the matrix polymer encapsulates and binds the wood together to resist moisture penetration and degradation from fungal rot. NFCs can be utilized for improving strength and other mechanical properties by replacing the WPC's wood flour reinforcement with suitable preforms of natural fibres for demanding applications.

Plastic trim products are polymer matrix WPCs, which are blends of 40%–60% wood flour in a thermoplastic matrix (PE, PP or PVC). Pultrusion is a continuous, high volume composite manufacturing process in which the materials (matrix resin and reinforcement) are pulled through a heated die of constant cross-section. The extruded parts are then cured/cooled, pulled and cut into a desired length. A wide range of profiles can be pultruded for applications such as exterior trims, shingles and sidings



Figure 14.5 Pultruded NFC products (courtesy of M.T. Ton-That et al, The Institute of Textile Science, Ottawa, ON, Canada).

(see Fig. 14.5). The performance properties are dependent upon matrix formulation and density of the composites. The higher density products are more dimensionally stable, stronger and indentation resistant, but are also more expensive. By adopting NFC technology, high-quality durable composite trim products can be manufactured. This type of products constitutes one of the promising potential NFC application areas.

SIPs have become widely used alternative construction materials for homes and other buildings. While many types of composite panel building systems have been developed, the SIPs usually refer to panels made from a thick layer of foam (PS or polyurethane) sandwiched between two layers of Oriented Strand Board (OSB), plywood or fibre-cement. As an alternative to the foam core, SIPs are available with a core of agriculture fibres (such as wheat straw) that provides similar thermal and structural performance. The result is an engineered panel that provides structural framing, insulation and exterior sheathing in a solid, one-piece component (PATH, 2011).

In the United States, the typical SIPs are supplied in 4 feet width. With vacuum-assisted resin transfer moulding (VARTM), very large complex monolithic composite structures such as entire walls, floors, loops and bridge deck can be manufactured from suitable combinations of NFC skin and core structures. A conceptual whole house based on the monolithic panels is shown in Fig. 14.6.

NFCs have the potential for major applications in building products. However, there are challenges for NFCs to enter these applications. NFCs are not cost-effective at this time because of low production volume together with high fibre cost. While the mechanical properties of NFCs may be adequate for applications of less demanding residential construction area, there is need of additional research for biocomposite structural components to become a reality in load-bearing applications (Goda et al., 2008).

14.6.2 Green composites for automotive applications

The automobile industry has been a leader in the use of composites made from long natural fibres. The lower mass density of natural fibres in comparison to glass and other



Figure 14.6 A concept house constructed with various NFC SIPs. (Courtesy of Dr. Anil Netravali).

mineral fibres reduces vehicle weight, which in turn means lower fuel consumption. NFCs in automobile interiors are beneficial to better safety due to fewer sharp fractured edges and improved comfort due to better acoustic and thermal properties (Miao and Finn, 2008). NFC applications in automotive components were reviewed thoroughly by Puglia et al. (2004). In this section, only recent developments will be discussed.

The US and European automakers have been using natural fibres (hemp, jute, kenaf, flax, sisal and others) to produce non-load-bearing components, such as dashboards and components, door panels, trunk panels, headliners, trunk components, floor panels and insulations (Fig. 14.7).

By applying suitable manufacturing techniques listed in Table 14.5, these various automotive components are produced. Thermoplastic matrices with appropriate natural preforms are used to fabricate these parts for ease of recycling, when part size is

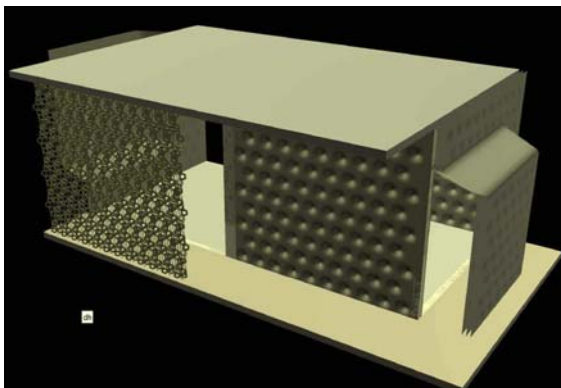

Figure 14.7 Auto parts made from various NFCs in a Mercedes S class vehicle.

relatively small and thermoforming techniques are acceptable. For high production rate, SRIM techniques are employed with fast reacting resin systems. Thermosetting resins are used for relatively large size parts by VARTM or resin infusion techniques. For example, the engine and transmission covers of Mercedes-Benz buses are fabricated with natural fibre/unsaturated polyester composites.

However, there are challenging issues for NFC products to be widely adopted in automotive applications. The mechanical properties of NFCs are strongly dependent upon the natural fibre reinforcement quality and consistency, which also depend on cultivars, harvesting practices, processing route and producing region. Natural fibres also degrade by fungal and mildew attack during extended storage and are susceptible to mechanical/thermal degradation during processing. Natural fibres are hydrophilic and possess poor compatibility with hydrophobic matrix resins, which results in low mechanical strength. The NFCs are sensitive to moisture and their mechanical properties depend on fibre length and orientation distribution (Schloesser, 2004).

14.6.3 Structural NFC composites by z-axis fibre reinforcement

To improve the mechanical performance of NFC, interfacial bonding between fibre and matrix needs to be improved, since stress is transferred between matrix and fibres across the interface. Good interfacial bonding is required to achieve optimum fibre reinforcement efficiency. However, for plant based fibre-reinforced composites there is usually limited interaction between the hydrophilic fibres and organic matrices which are commonly hydrophobic leading to poor interfacial bonding limiting mechanical performance as well as low moisture resistance affecting long-term performance properties.

In order to achieve improved interfacial bonding in NFCs, it may be classified into physical and chemical approaches. Physical approaches include corona, plasma, ultraviolet (UV), heat treatments electron radiation and fibre beating. Chemical approaches are more popular, since chemical process provides better interfacial strength improvements obtainable without requirements for expensive special equipment. Chemical treatments include alkali, acetyl, silane, benzyl, acryl, permanganate, peroxide, isocyanate, titanate, zirconate and acrylonitrile treatments and use of maleic anhydride grafted coupling agent (Singh et al., 1996). The most popular are alkali, acetyl, silane and maleic anhydride grafted coupling agent.

Pinto et al. (2014) studied structural applicability of NFC with improved performance of the jute/epoxy. They investigated the effects of preform architecture, surface treatment, and z-directional micro-fibre reinforcement on the interlaminar fracture performance of jute/epoxy laminated composites. In fact, low fibre volume fraction and uncontrolled void content are continuing problems in natural fibre composites. This study addresses these problems by enhancing interfacial adhesion between fibre and matrix, and drastically reducing void content by the optimization of the Vacuum Infusion (VI) fabrication process together with long jute fibre unidirectional fabric reinforcement rather than short fibres. The effects of reinforcement weave architecture,

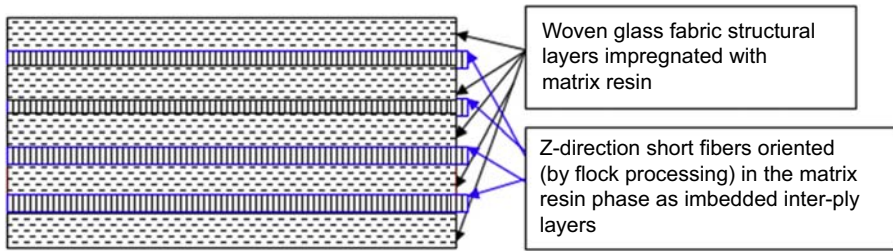

Figure 14.8 Diagram of woven glass fabric/Z-axis nylon fiber interlayer hybrid laminar composite (five glass fabric layers shown).

surface treatment, and fabrication method on the performance of jute fibre/epoxy laminated composites are:

- Unidirectional fabric architecture increased tensile modulus and strength by 40% and 34%, respectively, over plain weave preforms, at the cost of decreased interlaminar shear strength (ILSS).
- Fibre surface treatment increased the modulus and water resistance of jute/epoxy composites by 36% and 60%, respectively.
- Jute/epoxy laminar composites are comparable in stiffness to mass ratio with glass fabric/epoxy laminar composites.

Another problem shared by all laminated composite materials for structural applications is delamination. This is the most common mode of failure in this type of composite material, and may be initiated by several means such as impact, buckling, and out-of-plane loading. Laminated composites are susceptible to delamination because they lack fibrous reinforcement in the thickness direction. As such, several methods of incorporating through-thickness reinforcement have been developed and characterized, for example, Z-pinning and 3D weaving. These methods, while effective in increasing delamination resistance, have significant weaknesses. Z-pinning dramatically degrades the in-plane properties of the composite as the laminate is damaged, and 3D weaving is prohibitively expensive for most applications. A third type of Z-axis interlayer reinforcement (Fig. 14.8), UMass Dartmouth's patented Z-axis reinforcement 'wet-flocking' technology, has been shown in recent work to greatly improve interlaminar fracture toughness of glass fibre-reinforced composites with only moderate degradation to in-plane properties (Feng, 2006).

Kim et al. (2017) reviewed three modes of Z-axis flock fibre application. These methods are referred to as (1) 'wet' flocked, (2) 'dry' flocked and (3) 'pre-flocked'. In wet flocking, flock fibres were applied to an uncured, liquid resin impregnated fabric ply layer surface before the composite lay-up was assembled and consolidated. For dry flocking, Z-axis oriented short fibres first be applied directly to non-resin containing 'bare' fibrous mats or fabric. These flock fibre-containing layers could then be assembled, impregnated with a matrix resin and consolidated to form a finished laminate. The pre-flocked process is a more 'end user-friendly' approach to this Z-axis laminar ply reinforcement technology whereby flock fibres are tacitly applied to individual 'dry' fibrous laminar ply layers to form a 'stand-alone' composite ply layer material entity. This is accomplished by first applying a very thin sizing resin (wet and uncured)

to a fibrous reinforcing (fabric or mat) ply just before flocking. Allowing this thin resin sizing layer to cure in place serves to loosely secure the upright-oriented flock fibres in place. These flocked composite reinforcement layers from off-the-shelf are now ready for end-user's subsequent composite ply material assembly manipulation; this includes gentle material handling, long-term storage, materials packaging and manipulation as it is to be subsequently used to fabricate a laminate, without in-house flocking facility. They conclude that Z-axis oriented interfacial flock reinforcement fibres can drastically improve the Mode I fracture toughness of glass fabric, glass mat and jute (natural fibre) fabric laminar composites. This technology can be utilized to develop structural NFCs for construction and automotive applications.

Pinto et al. (2013) examined the effects of preform architecture, surface treatment, and Z-axis micro-fibre reinforcement on the interlaminar fracture performance of jute/epoxy laminated composites. In this study, laminated composites were fabricated using an optimized vacuum infusion process. Fracture toughness studies by DCB and ILSS methods showed that surface treatments increased fracture toughness as a result of improved interfacial adhesion. Unidirectional preforms were found to decrease fracture toughness as compared to plain weave preforms due to reduced inter-ply interaction. The addition of z-direction reinforcement increased the composites' Mode-I fracture toughness by 80% and improved ILSS by 13% and 16% for plain weave and unidirectional reinforcement. Through-thickness micro-fibre reinforcement greatly improved the delamination resistance of these composites, but degraded in-plane tensile properties due to the introduction of resin rich layers with non-aligned reinforcing fibres.

Therefore, future research and development for structural NFCs should be focused on fibre surface treatment, interfacial adhesion for better load transfer, and control of fibre orientation distribution for optimum preform configuration for structural NFCs. Furthermore, it is imperative to enhance fracture toughness and delamination control of structural NFCs based on natural fibres and advanced bioplastics matrix materials for expanding NFC applications that demands strength and durability.

14.7 Conclusions

New environmental regulations and changing governmental policy promoting materials derived from agriculture have provided the impetus to find new products and processes that are compatible with the environment and reduce carbon emission. The US housing and automotive industry studies clearly indicated the potential impact and opportunities for natural fibre bio-based structural composites. NFCs have a great potential for major applications in building products and automotive components.

Current building products and automotive components are non-structural applications, which limit the product spectrum and market size. For NFC structural components to become major player in load-bearing applications, a tremendous amount of research is required to overcome the shortcomings of biocomposites in structural applications. The focal points of the research include: improvement in natural fibre uniformity and strength and modulus; fibre surface treatment to promote interfacial

adhesion and lessen moisture susceptibility; bio-based thermoset and thermoplastic matrices of programmed biodegradability; composite fabrication processes to increase fibre content and fibre alignment, reduction of natural fibre degradation during composite fabrication; and micro- and macro-mechanical modelling of NFC stiffness, strength and creep behaviour to maximize performance of the NFCs.

Much research and progress has occurred in recent decades in the mechanical performance of NFCs. Improvement has occurred due to improved fibre selection, extraction, treatment and interfacial engineering as well as composite processing. NFCs now compare favourably with glass fibre—reinforced plastics (GFRPs) in terms of stiffness and cost; values of tensile and impact strength are approaching those for GFRPs. The lower densities for NFCs lead to better comparison for specific properties. NFC materials based on renewable resources can provide viable low-cost structural components and eco-friendly alternatives to conventional structural materials for automotive and constructional applications. Applications of NFCs have extended dramatically including load bearing and outdoor applications such as automotive exterior underfloor panelling, sports equipment and marine structures. Further research is still required to extend their application range including improvement in moisture resistance and fire retardance.

14.8 Future trends

Overall, the global NFCs market was estimated at US\$2.1 billion in 2010 and projected to rise 10% annually until 2016 reflecting further potential seen across a range of industries including automotive, aerospace, construction, civil and the sports and leisure industries (Ho et al., 2012).

The availability of low-cost structural components based on renewable resources will have a great impact on current and future construction and automobile manufacturing industries. Moreover, a fully developed NFC industry will create a large amount of natural fibre mill consumption in the future. Bio-based structural composites for construction and automotive industry applications are newly emerging materials (European Bioplastics, 2019-1, 2019-2) that will play important roles in next-generation building materials and automotive components not only for American automotive and housing industries but also for Europe and the whole world in the 21st century.

Acknowledgements

The author would like to thank Dr Samuel C. Ugbolue (University of Massachusetts, Dartmouth) for technical discussion, Dr Armand F Lewis for his extensive help in Z-axis interlayer reinforcement methodology, and their current and former graduate students (Sunil Hoskote, Liang Peng, Michael Pinto, Michael Salvucci and Sen Yang) for their intensive research and development work for Z-axis technology. We also sincere appreciation to Dr Anil Netravali (Cornell University) for sharing NFC technology.

References

- Alves, C., Ferrao, P.M.C., Silva, A.J., Reis, L.G., Freitas, M., Rodrigues, L.B., Alves, D.E., 2010. Ecodesign of automotive components making use of natural jute fiber composites. *J. Clean. Prod.* 18, 313–327.
- Aziz, S.H., Ansell, M.P., 2005. Optimizing the properties of green composites. In: Baillie, C. (Ed.), *Green Composites: Polymer Composites and the Environment*. Woodhead Publishing, Cambridge (Chapter 8).
- AZO Materials, 2019. <https://www.azom.com/article.aspx?ArticleID=8522>.
- Biagiotti, J., Puglia, D., Kenny, J.M., 2004. A review on natural fibre-based composites. Part I: structure, processing and properties of vegetable fibres. *J. Nat. Fibers* 1 (2), 37–68.
- Brzyski, P., Barnat-Hunek, D., Suchorab, Z., Łagód, G., 2017. Composite materials based on hemp and flax for low-energy buildings. *Materials* 10, 510. <https://doi.org/10.3390/ma10050510>.
- Corradi, S., Isidori, T., Corradi, M., Soleri, F., 2009. Composite boat hulls with bamboo natural fibres. *Int. J. Mater. Prod. Technol.* 36 (1), 73–89.
- European Bioplastics, 2019-1. <https://www.european-bioplastics.org/market/>.
- European Bioplastics, 2019-2. <https://www.european-bioplastics.org/bioplastics/materials/>.
- European Parliament and the Council, October 21, 2000. Directive 2000/53/EC of the European Parliament and the Council of 18 September 2000 on end-of life vehicles. *OJ L* 269 (34).
- Faruk, O., Bledzki, A.K., Fink, H.P., Sain, M., 2014. Progress report on natural fiber reinforced composites. *Macromol. Mater. Eng.* 299 (1), 9–26.
- Feng, L., 2006. Fracture Toughness of through Thickness Flock Fiber Reinforced Lamina Composites (MSc thesis). Univ of Mass Dartmouth.
- Goda, K., Takaki, H., Netravali, A.N., 2008. Fully biodegradable green composites reinforced with natural fibers. In: Thomas, S., Pothen, L.A. (Eds.), *Natural Fibre Reinforced Polymer Composites*. Old City Publishing, Philadelphia, PA (Chapter 13).
- Goede, M., Stehlin, M., Rafflenbeul, L., Kopp, G., Beeh, E., 2009. *Eur. Transp. Res. Rev.* 1 (5).
- Hanana, F.E., Rodrigue, D., 2015. Rotational Molding of Polymer Composites Reinforced with Natural Fibers, *Plastics Engineering*, July/August, 2015.
- Hancox, N.L., Mayer, R.M., 1994. *Design Data for Reinforced Plastics*. Chapman and Hall, London.
- Ho, M.-P., Wang, H., Lee, J.-H., Ho, C.-K., Lau, K.-T., Leng, J., et al., 2012. Critical factors on manufacturing processes of natural fibre composites. *Compos. Part B* 43 (8), 3549–3562.
- Joshia, S.V., Drzal, L.T., Mohanty, A.K., Arorac, S., 2004. Are natural fiber composites environmentally superior to glass fiber reinforced composites? *Compos. Part A* 35, 371–376.
- Kim, Y.K., Rice, J.M., Chalivendra, V., and Lewis, A.F., 2017. “Flock Fibre-Reinforced Lamina Composites for Improved Mode I Fracture Toughness”, *JEC Composites Magazine*, No. 110, January–February 2017.
- Kozłowski, R., Waldyka-Przybylak, M., 2004. Uses of natural fiber reinforced plastics. In: Wallenberger, F.T., Weston, N.E. (Eds.), *Natural Fibers, Plastics and Composites*. Kluwer Academic Publishers, Norwood, MA (Chapter 14).
- Kozłowski, R., Baraniecki, P., Barriga-Bedoya, J., 2005. Bast fibres (flax, hemp, jute, ramie, kenaf, abaca). In: Blackburn, R.S. (Ed.), *Biodegradable and Sustainable Fibres*. Woodhead Publishing, Cambridge (Chapter 2).
- Kymäläinen, H.R., Sjöberg, A.M., 2008. Flax and hemp fibres as raw materials for thermal insulations. *Build. Environ.* 43 (7), 1261–1269.

- Mazumdar, S.K., 2002. *Composites Manufacturing: Materials, Products, and Process Engineering*. CRC Press, Boca Raton, FL.
- Miao, M., Finn, N., 2008. Conversion of natural fibres into structural composites. *J. Text. Eng.* 54 (6), 165–177.
- MILHDBK-17, 1992a. *Military Handbook 17-1C, Polymer Matrix Composites, Vol I: Guidelines*. Department of Defense, Washington, DC.
- MILHDBK-17, 1992b. *Military Handbook 17-2C, Vol II: Material Properties, and 17-3D; Vol III: Utilization of Data*. Department of Defense, Washington, DC.
- Netravali, A.N., 2005. Biodegradable natural fiber composites. In: Blackburn, R.S. (Ed.), *Biodegradable and Sustainable Fibres*. Woodhead Publishing, Cambridge (Chapter 9).
- O'Donnell, A., Dweib, M.A., Wool, R.P., 2004. Natural fiber composites with plant oil-based resin. *Compos. Sci. Technol.* 64, 1135–1145.
- Oksman, K., Skrifvars, M., Selinc, J.-F., 2003. Natural fibres as reinforcement in polylactic acid (PLA) composites. *Compos. Sci. Technol.* 63, 1317–1324.
- Osswald, T., Bauer, E., Brinkmann, S., Oberbach, K., Schmachtenberg, E., 2006. *International Plastic Handbook*. Hanser Verlag, Munich.
- PATH, 2011. Available from: <http://www.toolbase.org/Building-Systems/Whole-House-Systems/structural-insulated-panels>.
- Petrovic, Z.S., Guo, A., Janvi, I., Zhang, W., 2004. Plastics and composites from soybean oil. In: Wallenberger, F.T., Weston, N.E. (Eds.), *Natural Fibers, Plastics and Composites*. Kluwer Academic Publishers, Norwood, MA (Chapter 11).
- Piggott, M., 2008. *Load Bearing Fibre Composites*, second ed. Kluwer Academic Publishers, Boston, MA.
- Pinto, M., Chalivendra, V., Kim, Y., Lewis, A., December 2013. Effect of surface treatment and Z-axis reinforcement on the interlaminar fracture of jute/epoxy laminated composites. In: *Engineering Fracture Mechanics*, vol. 114, pp. 104–114.
- Pinto, M., Chalivendra, V., Kim, Y., Lewis, A., 2014. Evaluation of surface treatment and fabrication methods for jute fiber/epoxy laminar composites. *Polym. Compos.* 35 (2), 310–317.
- Puglia, D., Biagiotti, J., Kenny, J.M., 2004. A review on natural fibre-based composites. Part II: application of natural reinforcements in composite materials for automotive industry. *J. Nat. Fibers* 1 (3), 23–65.
- Sain, M., Panthapulakkal, S., 2005. Green fibre thermoplastic composites. In: Baillie, C. (Ed.), *Green Composites: Polymer Composites and the Environment*. CRC Press, Boca Raton, FL (Chapter 9).
- Schoesser, T., 2004. Natural fiber reinforced automotive parts. In: Wallenberger, F.T., Weston, N.E. (Eds.), *Natural Fibers, Plastics and Composites*. Kluwer Academic Publishers, Norwood, MA (Chapter 15).
- Schwartz, M.M., 1997. *Composite Materials*, vol. 2. Prentice Hall, Upper Saddle River, NJ.
- Singh, B., Gupta, M., Verma, A., 1996. Influence of fiber surface treatment on the properties of sisal-polyester composites. *Polym. Compos.* 17 (6), 910–918.
- Strong, A.B., 2008. *Fundamentals of Composite Manufacturing*, second ed. Society of Manufacturing Engineers, Dearborn, MI.
- Uddin, N., Kalyankar, R.R., 2011. Manufacturing and structural feasibility of natural fiber reinforced polymeric structural insulated panels for panelized construction. *Int. J. Polym. Sci.* 963549.
- Wikipedia, 2019. <https://en.wikipedia.org/wiki/Hempcrete>.
- Wool, R.P., Sun, X.S., 2005. *Bio-Based Polymers and Composites*. Elsevier/Academic Press, Boston, MA.

Further reading

Osborn Industries, 2011. Available from: <http://www.osborneindustries.com/rtm-molding-definition.php>.

Ton-That, M.T., Denault, J., 2012. Development of Composites. Based on Natural Fibers. Available from: www.textilescience.ca/downloads/presentation_Naturalfiber.pdf.

Natural fibres for geotextiles

15

Sivoney Ferreira de Souza¹, Bibin Mathew Cherian²,
Alcides Lopes Leão², Ryszard M. Kozłowski³, Sabu Thomas⁴

¹University of Potsdam, Institute of Chemistry, Physical Chemistry, Potsdam, Germany;

²College of Agricultural Sciences, São Paulo State University, Botucatu, São Paulo, Brazil;

³Journal of Natural Fibers Editor-in-chief, coordinator of FAO/SCORENA European Cooperative Research Network on Flax and other Bast Plants, former director of the

Institute of Natural Fibres, Poznan, Poland; ⁴Department of Polymer Science and Engineering, School of Chemical Sciences, Mahatma Gandhi University, Kottayam, Kerala, India

15.1 Introduction

Geotextiles are recently emerging technologies in geotechnical and bioengineering fields. Geotextiles are not a single commodity. These are fabricated by both synthetic and natural fibre with different design, shape, size, composition according to its functional need.

Geosynthetic is a term composed of ‘geo + synthetic,’ meaning ‘earth + a product manufactured by man’. These are designated as a flat product made from polymer materials (synthetic or natural) used in contact with massive natural soils or rocks, or other material in geotechnical engineering works (Ferreira Gomes, 2001). The geosynthetic material, despite being relatively new, has had a fast development. The first application of a geotextile fabric of cotton, in building roads, occurred in the United States around 1930 (Beckham and Mills, 1935). The emergence of synthetic polymer started in later 60’s with the development of polyolefins and polyester resins. The first application of a geotextile synthetic fibres dates from 1950, in Florida (Barrett, 1967). In Europe, the application of geotextile fabric (Gicot and Perfetti, 1982) dates from 1960 in the Netherlands and non-woven geotextiles in 1969 in France (Ferreira Gomes, 2001). It is after the 70s, that there is a great development with the emergence of other materials such as geomembranes, geogrids, geocomposites and others leading to the term geosynthetic already in the 80s, as a more generic name, thus encompassing the geotextiles, geomembranes and all related products.

It is in this context that in 1977 the first major international event in Paris on the subject, returning later in 1982 to be held in Las Vegas in 1986 in Vienna in 1990 in The Hague (1994) in Singapore in 1998 and Atlanta in 2002, with a good performance in the seventh international conference on geosynthetics. Due to the importance of the issue, we highlight the establishment of the International Society of Geotextiles in 1983 in Paris and the emergence of the International Geosynthetics in 1994. However, there is the appearance of several journals specialist, with emphasis on

the 'International Journal of Geotextiles and Geomembranes' from 1987 and Geosynthetics International since 1994, and some textbooks and teaching reference on the subject deserves, the works of authors (Adelman et al., 2012; Ghosh, 2009; Gicot and Perfetti, 1982; Ingold, 1994; Koerner, 2016; Koerner and Soong, 2001; Shukla, 2016; Santvoort, 1994; Veldhuijzen van Zanten, 1986).

15.2 Natural vegetable fibres for geotextiles and their suitability

Natural fibres can be sourced from animals (e.g. Wool and Silk) or from plants (vegetable fibres). The limited quantity of animal fibres produced world over has very well-defined apparel end uses and do not come under question as raw material for geotextiles.

The vegetable fibres can be grouped into three classes namely bast fibres, leaf fibres and seed/fruit fibres. Bast fibres are extracted from stems of plants and the other two groups are self-explanatory. In terms of quantity of production, each of the bast fibres such as jute and flax, leaf fibres such as sisal and curaua, and seed/fruit fibres like cotton and coir are cultivated to more than 100,000 m.t./annum, whereby production of cotton is greater than any of these fibres by an order of 2. The bast fibres are much softer than the leaf fibres and hence enjoy a more diversified end-use. Flax, hemp and ramie are used in twines, canvases, fishnets, firehoses etc., whereas the leaf fibres are employed as cordage material or even as mats. Coir has similar end uses as the leaf fibres, whereas cotton is used mostly in apparels and jute in sacking and carpeting. All these materials can be cultivated more intensively as suitable new end uses are found out. A fibre material would be suitable for geotextile when it has reasonably good mechanical properties, and it is reasonably resistant to biodegradation depending on their application.

The bast fibres namely flax, hemp and ramie have very high tenacity values (between 45 and 66 cN/tex) and low extension at break (1.6%–3.8%). Jute is weaker than the fibres named (Ca. 30 cN/tex) but extends almost as much at break. In tenacity, the leaf fibres are slightly stronger than jute but weaker than the other three bast fibres and in extension at break they behave similar to the bast fibres. The tenacity of coir fibres on the other hand is very low (15 cN/tex) but elongation at break much higher (around 40%). Therefore, these fibres could be used as geotextiles, although sisal fibres compared favourable against other commercially produced leaf fibres. In fact trials with sisal fibres for erosion control have been reported to be encouraging (Chemistry, 1985).

Regarding the natural geotextiles, durability is not a matter of concern when a short service life is required, as for drainage for consolidation of soft compressible deposits: and also when the geotextile use is also limited to specific functions, such as improving the soil interface properties. In drainage applications a periodic replacement can be planned, and for membranes the natural fabric can be a placement aid when used in conjunction with woven synthetics.

Indeed, the composition of natural fibres can also affect the final properties of geotextile and it is an important feature to design mats according to the required shelf life. Indeed, the growth of microorganism on vegetable fibres depends on their chemical composition. The lignin content plays hereby an important role since lignin presents fungal inhibition (Dos Santos et al., 2016; Mohan et al., 2008). In this respect,

coir fibre with about 35% lignin content stands out as extremely resistant followed by jute (ca.12%) and leaf fibres (about 10%). The other bast fibres contain much lower quantity of lignin (0.6%–3.3%). Even in content of lignin/hemicellulose ratio, jute, coir and leaf fibres appear to have distinct advantage over the other bast fibres. In terms of the crystallinity of the cellulose content, which also influences the biodegradability (Chemistry, 1985), no comparative results are available for these different fibres although it is quite high for the leaf fibres and low for coir, as an example of seed fibre. In addition to exploring applicability of jute and coir fibres for geotextile and uses, the leaf fibres should also be considered as potential raw material.

As described by the website Technical Textile, the geotextile made of natural fibres like Jute has the potential to mix with the soil and later, act as a nutrient for the soil and to the vegetation due to their biodegradable character. In case, Jute has fast degradation however, this can be overcome according to chemical treatments or blending compositions reaching a life span of 20 years. Even though, jute is not the best material for some geotextile applications, it has been used quite satisfactorily, as separator, reinforcing and in drainage activities, along with topsoil erosion in shoulder and cracking. In addition, after degradation of jute geotextiles, lignomass is formed, which increases the soil organic content, fertility, texture and also enhance vegetative growth with further consolidation and stability of soil (Technical Textile accessed march, 2019).

15.3 Types of synthetics geotextiles

As already noted, the geosynthetics had a very rapid growth, which led to the appearance as a result of a wide variety of such materials, even within the type of geotextiles. Geotextiles are distinguished by their constituent elements (fibres) and also by its structure, resulting from the manufacturing process. Geotextiles can be grouped mainly into two major groups: woven and non – woven (Fig. 15.1). Non-woven geotextiles are used in applications which require higher filtration capability than is obtainable with woven geotextiles, and large widths are necessary. The non-woven geotextiles are made of fibres or randomly oriented and connected in a flat structure.

A geotextile fabric is obtained by interlacing, usually at right angles (woven), two filaments of several bundles of filaments or bands. This connection can be obtained by

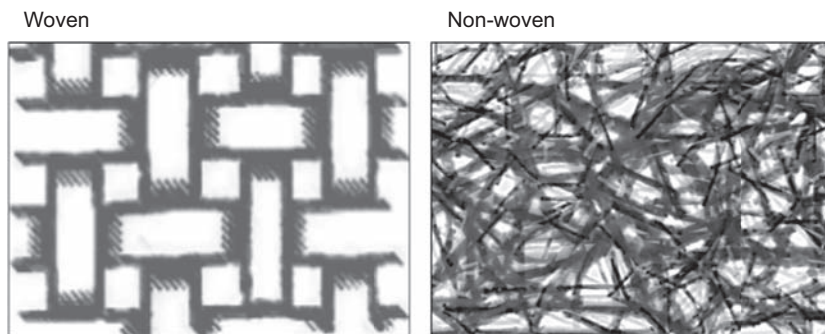

Figure 15.1 Basic geotextile structures.

mechanical (interlocking of the filaments caused by needles, referring to this case of stitching), chemicals (the connection is made by bonding fibres using resins or emulsions) and thermal (the connection is made by partial melting fibres achieved by joint action of temperature and pressure exerted by two heated rollers).

Besides the main categories of geotextiles, there are other types, such as knitted geotextiles, tissues of broad bands, geotextiles alveolar, geotextiles and other fillings. Regarding composition, geotextiles are made of textile fibres that can be natural and/or synthetic. Natural fibres such as wool, silk, cotton, flax, hemp, pineapple leaf fibres that is seldom used, given their behaviour biodegradable (Ferreira Gomes, 2001), but also made of jute, sisal, curaua (Souza et al., 2015), coconut and others. Among the highlights, there are synthetic polymers that are most used in the manufacture of geotextiles and related products. The main synthetic polymers are: polyester, polyamide, polyethylene, low density polyethylene, linear low density polyethylene, high density polyethylene, polypropylene, polystyrene, polyvinyl chloride, copolymer of ethylene with bitumen and chlorinated polyethylene (Ferreira Gomes, 2001).

Geotextiles are used in numerous civil engineering applications for reinforcement, filtration, separation, drainage and erosion control. There are main four types of polymers used as raw materials: polyester, polypropylene and polyethylene (Arun Hegde, 2017). They can be woven, non-woven, knitted, knotted, grids, membranes and even composite materials. They represent one of the fastest growing markets of all technical textiles. In a recent document entitled 'A competitiveness analysis of the UK technical textiles sector' commissioned by the DTI, UK, amongst the areas highlighted as having above average growth potential over the next decade especially within the UK and wider European markets, the non-woven and woven geotextiles show 5.9% and 5% growth per annum in value terms respectively (Anand, 2008). In fact, geotextiles are multi-functional and location specific in nature. Bioengineering/agro mulching of natural fibrous materials are most effective due to their biodegradability, eco-compatibility and improvement of soil fertility, stabilizer and texture. In addition to erosion control they also facilitate vegetative growth, weeding and soil protection from rain, wind, light and cold etc (Abdullah, 2008). These applications are generally categorized as; application at the interface of the formation of soil and the delay of crack development in asphalt; restraint of soil through filtration and drainage by filter cake formation (Abdullah, 2008).

Moreover, the high absorbency of non-woven geotextiles promotes adhesion to road surfaces and flow resistance to water. Geotextile fabrics of woven construction are used in applications requiring higher strength and structural stability than is obtainable with non-woven geotextiles. In producing a geotextile fabric, it is particularly desirable to have controlled strength and controlled elongation, with high tear resistance and proper filtration also being highly desirable. Geotextile fabric is produced that has excellent tear resistance, and very precisely controlled elongation and strength. For some particular uses of the geotextile fabric according to the invention, the extensibility is about 2%–4%, making the fabric useful for solving 'reflective cracking' problems in paving and the like.

15.4 Market size of natural fibre geotextile

According, to the magazine Markets Insider (3 November 2017), U.S. woven geotextile market size may exceed USD 650 million by 2024 while, in the same period, China geotextile demand for railroads will exceed USD 95 million and there is a forecast for India geotextile market that will exceed 12.5% related to geotextiles applied in erosion control (Arun Hegde, 2017). Basically, geotextiles market for 2018 was distributed according to the graph on Fig. 15.2 (Geotextiles Market Size & Share, 2009).

In the same article, there is a forecast for 2024 that geotextiles crossing 10 billion m^2 with a profit of over USD 12 billion because the different benefits that can be achieved with the advance of technology and better prices compared to the conventional materials (Arun Hegde, 2017).

In this scenery, natural fibres such as coir fibres brings innovation for being durable, resist sunlight, biodegradable, absorb water, it favours seed germination allied to the use of synthetics geotextile. Nowadays, the consumption of geotextile for erosion control and roadways seems to be a key driver for the development of the market as described in a review of geotextile products where the main raw material is synthetic polymers (Das et al., 2017). At present the use of natural fibre geotextiles is mainly applied to control of hill slope erosion and erosion in the perimeter of slow flowing minor water courses such as small rivers and ditches. It is noted that the USA consumption of 53 Mm^2 (millions of square meters) for erosion control, relates to synthetic products applied to both hill slope erosion control and erosion control of armoured revetments applied to coastal sites and substantial water courses such as large rivers and navigable waterways, while 163 Mm^2 for separation and filtration; 132 Mm^2 for pavement repair and 100 Mm^2 for waste disposal (Roul, 2009).

Hill slope erosion control can be achieved in many different ways including land management, vegetation and the application of a protective covering. The protective covering can be applied using a variety of techniques such as mulching, sprayed emulsions and sheet like products which fall under the general category of rolled erosion control products.

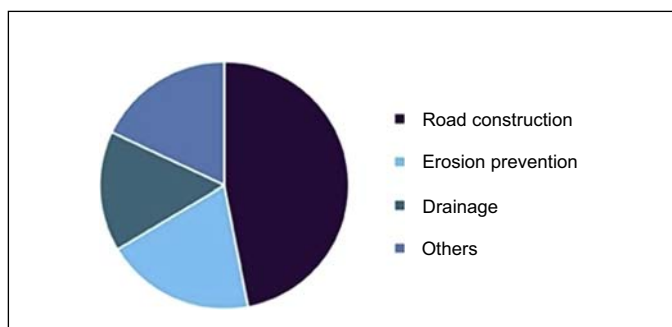

Figure 15.2 Global geotextile market share, by application, 2018.

Meanwhile, besides the geotextile employment in the erosion control industry, new and novel products are being developed which exploit advantageous from the fabric/ground interaction properties. The largest potential for development is to use these natural products temporarily to strengthen the ground, during and just after construction, until the soil consolidates and becomes stronger. These reinforcing geotextiles then biodegrade leaving no extra residue in the ground (Horrocks and Anand, 2000) and also it can be cheaper than conventional materials with higher shelf life as detailed in a study case where jute geotextile was applied in an unpaved road laid to reinforce the soil that it is still giving good service even after a lapse of 7 years (Rao, 2003).

Therefore, natural fibres can be competitiveness with geotextile produced by synthetic polymer since the tensile strength of vegetable fibres may have superior properties compared to the mid-range reinforcing synthetic geotextiles for soil reinforcement since the properties for natural fibre can be between 100 and 200 kNm⁻¹ and frictional resistance (an approximately 1) (Horrocks and Anand, 2000).

In fact, there is no regulation correlated to the use of geotextiles and to increase the demand of this materials it should have a regulatory support to develop this field in emerging countries such as India, China, United Arab Emirates and Brazil (Das et al., 2017). Indeed, the success of synthetic geotextiles is due to excess manufacturing capacity and the large amount of research and development correlated to their production, properties and application and not simply because they are superior to geotextile made from natural fibres (Rawal et al., 2016).

15.5 Functional requirements of geosynthetic materials

As stated earlier that the geotextiles can perform several functions either individually or simultaneously, this versatility relies upon their structural, physical, mechanical and hydraulic properties. The general properties required to perform this function are given in Table 15.1 as described before (Pritchard, 2000; Rawal et al., 2016).

Geotextiles provide an invaluable solution to the problem of constructing embankments over soft compressible ground where water fills the pores between soil particles under the embankment. The load from the embankment fill increases the tendency for the embankment to fail (Pritchard, 2000). The use of geotextiles at vertical increments in an embankment and/or at the bottom of it between the underlying soft soil and embankment fill would provide extra lateral forces that either prevent the embankment from splitting or introduce a moment to resist.

Solution of a geotechnical problem usually involves improvement upon a number of functional characteristics of the concerned soil. Thus, prevention of erosion of a river bank through application of geotextiles involve planting a suitable fabric within the soil that would permit easy flow of water without removal of soil particles (filtration) as also inducing vegetation growth on the embankments possibly by laying a soil-saver on the exposed surface. Similarly, a road abutment would call for suitable reinforcing agent as also a suitable find rain to prevent build-up of any pore water pressure. By way of an illustration, the functional requirements for some typical applications have been listed in Table 15.2 (Leão et al., 2012). It is observed that in all these

Table 15.1 Functional requirements for reinforcing geotextiles.

Properties	Reinforcement	Filtration	Separation	Drainage	Erosion control
Tensile strength	iii	i-ii	ii	na	ii
Elongation	iii	i-ii	iii	i-ii	ii-iii
Chemical resistance	ii-iii	iii	iii	iii	i
Biodegradability	iii	iii	iii	iii	iii
Flexibility	i	i-ii	iii	i-ii	iii
Friction properties	iii	i-ii	i	na	ii
Interlock	iii	iii	ii	ii	i
Tear resistance	i	iii	iii	ii-iii	ii
Penetration	i	ii	iii	iii	ii
Puncture resistance	i	ii	ii	iii	i-ii
Creep	iii	na	na	na	na
Permeability	na-i	ii-iii	ii-iii	iii	ii
Resistance to flow	i	i	i	i	iii
Properties of soil	iii	ii	na	na	na
Water	iii	iii	iii	iii	iii
Burial	iii	iii	iii	iii	na
UV light	ii	na	na	na	iii
Climate	na	iii	i	iii	iii
QA & control	iii	iii	ii	iii	i
Costs	iii	iii	iii	iii	iii

i – Highly important, ii – important, iii – moderately important, na – not applicable.

Reprinted from Rawal, A., Shah, T.H., Anand, S.C. Geotextile in Civil Engineering, Handbook of Technical Textiles, second ed., pp. 111–133, Copyright (2016), with permission from Elsevier.

cases, a multidimensional improvement is called for necessitating probably an assembly of different types of geosynthetic materials, whereby the relative importance of different functions in any particular application can be different from another application. Accordingly, the lifespan requirement of a particular geosynthetic material should be spelt out in terms of the duration of the expected functions. Thus, for example, in stabilization of a road, the separation and reinforcement functions could be very important during the initial years but on gradual consolidation over a period of time and with

Table 15.2 Functional requirement of some typical geotechnical problems.

	Functions							
	Filtration	Drainage	Separation	Protection	Encapsulation	Reinforcement	Erosion control	Confinement
Stabilization of soil slopes		*			*	*	*	
Reinforced soil walls		*				*		
Stabilization of road	*	*	*			*		*
Railroads track bed stabilization	*		*			*		*
Embankment on soft soil	*		*			*	*	
Landfills	*	*	*	*	*			
Erosion control on slopes							*	*
Land reclamation	*		*			*		
River bank protection	*		*				*	

Reprinted from Leão, A.L., Cherian, B.M., De Souza, S.F., Kozłowski, R.M., Thomas, S., Kottaisamy, M., Natural fibres for geotextiles, Handbook of Natural Fibres, first ed., pp. 280–311, Copyright (2012), with permission from Elsevier.

an efficient operational drainage system, the two functions may gradually lose significance. In such cases it is not sensible to spend money on a geosynthetic system that would exhibit hardly any change in strength over a long period of time. In other words, effective cost of a geosynthetic application can be improved by avoiding overdesigning with the best available material.

Another moot point to pond upon is the interplay between cost effectiveness vis-a-vis boundary constraints. The cost effectiveness of a particular solution might be theoretically improved by employing superior and hence more costly material that would last longer. But the desired durability of a particular treatment itself is a function of several factors. For example, the desired lifespan of a treatment carried out on an important and busy road is surely different from that on a less frequented one. Similarly, the availability of funds or the urgency for a particular work at any instant of time might not permit the luxury of the best solution. Hence an intricate interplay of the prevailing factors at any point in space-time might lead to application of very different types of geosynthetic materials for solution of two absolutely similar geotechnical problems. The argument of cost effectiveness of superior materials that would guarantee a longer life span and less maintenance can thus be very misleading. It might be quite sensible to focus more on 'Return on Investment' or on 'Profitability analysis'.

Man-made polymeric materials such as Polypropylene, Polyethylene and Polyester are considered to be chemically inert in conditions such as to be encountered in soil. Hence properties of these materials are by and large expected to remain unchanged over a much longer period as compared to natural fibres such as natural fibres. Such chemical inertness of the man-made polymeric materials also means that the health of soil and water would not be affected by the presence of these foreign materials, but this behaviour occurs when it is used pure or virgin polymer (Gillon and MirafTAB, 2004). Polymers of such grades would be very expensive and won't be employed for production of geosynthetics. One is more likely to fine recycled raw materials employed for such end uses. Such recycled materials may not only carry traces of highly toxic substances but their chemical inertness too becomes a subject matter of speculation. No information is available in accessible literature on such non-standard materials. It is thus incorrect to assume that geosynthetics made of polyester, polypropylene and polyethylene are inert and harmless to soil.

It is apparent from discussions in the foregoing that the 'superiority' of geosynthetics made of man-made polymeric materials over those of natural fibres can be a very subjective and at times even a wrong notion.

15.6 Primary uses for geotextiles

There are four primary uses of geotextiles in roadway construction and maintenance: (1) separation or stabilization; (2) drainage; erosion control; reinforcement.

15.6.1 Separation or stabilization

The geotextile is used to permanently separate two distinct layers of soil in a roadway. The classic example is where a road is to be built across a poorly drained, fine-grained soil (clay or silt) and a geotextile is laid down prior to placing gravel. This keeps the

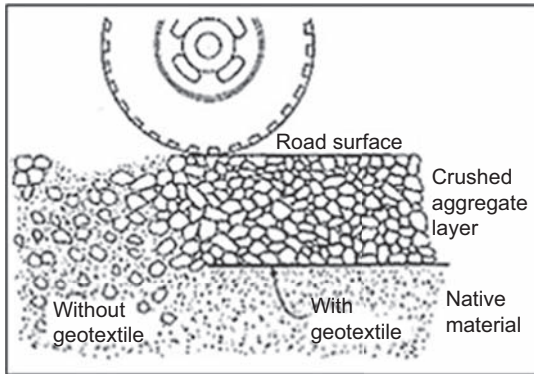

Figure 15.3 Concept of separation function of natural geotextiles (Hitkari Fibres Ltd., 2019).

soft, underlying soil from working its way up into the expensive gravel and it keeps the gravel from punching down into the soft soil. The full gravel thickness remains intact and provides full support for many years (Fig. 15.3).

15.6.2 Drainage/filtration

The geotextile acts as a filter through which water passes while it restricts fine-grained soil from entering into coarse-grained soil (sand or gravel). An example is in an under-drain where gravel-filled trenches lined with a geotextile fabric are constructed along the edges of roads. The fabric allows water to drain into the trench, while it permanently separates the different soil materials. The gravel remains clean and cannot 'plug up' with fine material. Not only can it be used in roadways, but also under parking lots, walls, athletic fields, lawns, tennis courts, and other areas.

The opportunity of using geotextiles is a relevant alternative to the traditional granular filters due to the reduction on the availability of high-quality granular materials and the increasing need for reduction in green gas emissions associated with the production of granular materials, most especially those produced from natural rock formations (Veylon et al., 2016). Also, the composition of geotextile fillers involved in the filtration process includes the geotextile, the interface between the geotextile and the natural soil, and between the geotextile and the drainage material (Veylon et al., 2016). It should be noted that the functional requirements of geotextiles as hydraulic filters mainly include its separation, filtration, drainage, and reinforcement (Diaz, 2016).

In Fig. 15.4, it is possible to see a scheme of how geotextile filter works during certain time. In this research, it was studied the behaviour of geotextile drainage of non-woven needle-punched and woven strip mats after 18 years showing that mechanical resistance and filtration properties were still observed (Veylon et al., 2016).

Similar system was studied with permeable pavement where the geotextile is working as a filter which allows the liquid to pass through the geotextile blocking the path of solid particles (Tota-Maharaj et al., 2012). In this study, it can be seen the efficiency of using two geotextile membrane where the water goes through the pipe totally transparent when compared to the experiments without and with just one membrane as pointed by the red arrow, Fig. 15.5.

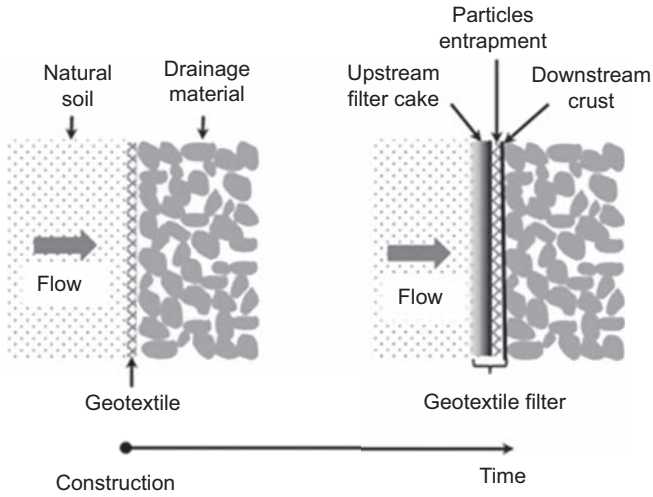

Figure 15.4 Filtration function of geotextile.

Reprinted from Veylon, G., Stoltz, G., Mériaux, P., Faure, Y.-H., Touze-Foltz, N. Performance of geotextile filters after 18 years’ service in drainage trenches. *Geotext. Geomembr.* 44 (4), 515–533, Copyright (2016), with permission from Elsevier.

15.6.3 Erosion control

A layer of heavy stones or broken rocks is commonly used to provide erosion protection for stream banks, culverts, ditches, stream channels, shorelines, and bridge structures. A geotextile placed between the rock layer and the underlying soil surface provides anchorage of the underlying soil and protects it from erosion and wave attack.

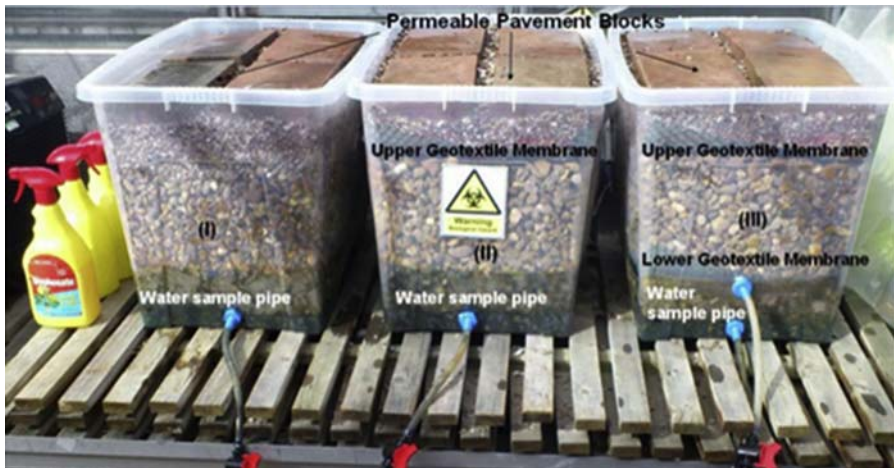

Figure 15.5 Photograph of three experiment: (I) without geotextile; (II) upper geotextile membrane; (III) upper geotextile membrane and lower geotextile membrane with a red arrow pointing to the water removal (Tota-Maharaj et al., 2012).

15.6.4 Reinforcement

In some areas, construction is proposed in ‘soft’ areas where the foundation soils are too weak to support a road or structure. Without sufficient reinforcement, the foundation cannot ‘hold up’ the structure and it fails at considerable expense. The geotextile is subjected to a sustained tensile force or load. Soil and rock materials are noted for their ability to withstand compressive forces and their relative low capacity for sustained tensile forces. In much the same way that tensile forces are taken up by steel in a reinforced concrete beam, the geotextile supports tensile forces that cannot be carried by the soil in a soil–geotextile system.

Lateral displacement of aggregate particles may occur after repeated traffic loading is a mechanism that degrades the mechanical properties of the structure below the road. This displacement is more relevant directly below the wheel path, where tensile stresses and fractures or cracks can nucleation. In Fig. 15.6(a), there is a scheme showing the lateral displacement without geotextile. The displacements result in decreased lateral stresses (i.e. decreased confinement) of the aggregate structure, which significantly impact the modulus of the base material. As described before, in a multi-layer pavement system, the main characteristic of the base layer is its comparatively high modulus, which widens the distribution of vertical loads and ultimately decreases the maximum vertical stresses acting at the base-subgrade interface. Traffic-induced degradation of the initial modulus in the aggregate structure arises in increasing contact pressures at the base-subgrade interface and eventually high rutting depths in the roadway structure (Zornberg, 2017).

Fig. 15.6(b) is showing the restrain to lateral displacement due to the geosynthetic presence. There is a transference of the shear stresses from the base material into tensile stresses in the geosynthetic. Consequently, comparatively high interface shear transfer is needed to achieve stabilization of the base layer. Furthermore, the tensile stiffness of any geotextile or geosynthetic used also contributes to determine the development of lateral strains. Thereafter, the geosynthetic or any geotextile applied to this function must have high stiffness to achieve stabilization of the base. In a previous study, it was identified one significant parameter the stiffness of the composite of soil/

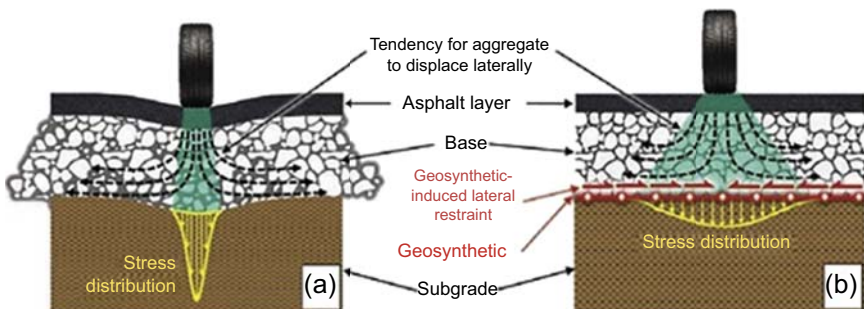

Figure 15.6 Geosynthetic or synthetic geotextile in road stabilization: (a) roadways designed without geotextile and (b) with geotextile.

Reprinted from Zornberg, J.G., Functions and applications of geosynthetics in roadways. Proc. Eng. 189, 298–306, Copyright (2017), with permission from Elsevier.

geotextile, which accounts for both the interface shear strength at the soil–geotextile interface and the geotextile stiffness. The increased confinement provided by the geotextile layer in the base course material leads to an increase in the mean stresses, leading also to an increase in the shear strength of the base (Zornberg and Gupta, 2010). They concluded that the lateral restraint comes from both frictional and interlocking characteristics of the interface between the soil and the geosynthetic. Therefore, when geotextiles are selected for base stabilization, proper interface frictional capabilities should be provided. Fig. 15.6(b) present a scheme where there are comparatively higher modulus of the geosynthetic-stabilized base spreading in a wide distribution of vertical traffic loads and in comparatively smaller vertical stresses (Zornberg, 2017).

15.6.5 Sediments control

Also, rolls stuffed with straw or coir fibre bundles (fascines, logs, wattles) may act as slope interruption devices or sediment retention. They are very popular with builders because of its low cost is the hydroseeding of disturbed sites (Leson et al., 2010).

15.7 Applications

Geotextiles are used in wide range of areas. Following are some important application areas where treated–untreated, blended–nonblended, natural and synthetic, geotextiles are used. They may be woven or non-woven, knitted-netted, corded, composite and sandwiched etc. But application of geotextiles is location specific so in addition to the characteristics of geotextiles, identification and application of geotextiles depends on soil type, soil composition, moisture content, liquid limits, plasticity index, bulk density, soil pH, iron/calcium content, clay/silt and sand composition, land sloping & hydraulic action etc.

15.7.1 Functions and applications of geotextiles in civil engineering

For geotextiles perform their functions, there are a number of properties that they must meet in regard to their characteristics, such as its thickness, its surface mass, its porosity, the transmissivity, the permissiveness of tensile strength, tear resistance, puncture resistance and deformability. The needs may vary depending on the characteristics of each application but herein we are showing the main ones, but still there are some researches being developed with new fields.

Some characteristics of geotextiles is essentially based on determined functions that mats can produce in contact to the soil and water as described below at Fig. 15.7, which are protection; separation; filtering; drainage, and reinforcement. Other functions could be mentioned, however, these ones may be considered the more relevant for their applications in these environmental conditions.

Geotextiles to be applied, are most often performing in different roles, for example, if you want to drain a local and involves an area of gravel with geotextile, this function is to

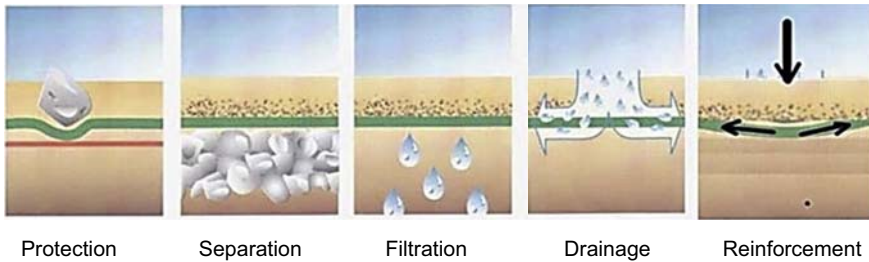

Figure 15.7 Main functions of geotextiles in order to meet their performance (Ferreira Gomes, 2001).

drain separator and filtering: serves to drain because the water percolates through it very easily, has the function of separator as a zone of natural soil with many thin, does not come into contact with gravel, avoiding the mix of materials and in turn clogging the drain, it has the filtering function, for passing up the fabric to retain soil and water, acts as a filter. Thus, due to its multiple functions geotextiles have applicability in so many engineering works such as roads, embankments, earth dams, canals, tunnels, railways, retaining walls, foundations of buildings, golf courses, soccer fields, landfills, cemeteries, airports, and many others (Ferreira Gomes, 2001). Then, we present some applications to the following detailed explanation of the various functions of geotextiles.

(i) Protection

With the function of protection is intended to reduce the geotextile localized actions in order to prevent or reduce damage to another surface or layer. A very typical use of geotextiles in protection, the application is in landfills, to involve geomembranes in order to protect the latter mainly due to actions caused by sealing materials angular shape (Fig. 15.8(a) and (b)) protecting them from possible punctures. The structure of the geotextile provides a cushioning effect, and the redistribution of stresses caused by loads, the more effective the denser and compact for the geotextile. A similar situation is applied to ponds, canals and ponds. They are also used for erosion protection, whether on slopes, flat surfaces, canals, marine works and many other cases.

In situations where very critical, very erodible soil, they use the geomancers, sometimes with a core composed of straw and/or substances that promote rapid germination of tree species (Fig. 15.8(c)–(f)). Geotextile absorbs the impact of rainwater that falls and dissipates the energy of the water depth that runs down the slope. Protects you from further wind erosion, and mitigates the effect of the sun, keeping the soil moisture. Geotextiles, this function, are also used beneath rockfill and other coating materials (Fig. 15.8(g)–(i)). Without geotextile to wave action and water movement would cause soil erosion below the rockfill structure, compromising the integrity of the work.

It is widely accepted that the establishment of permanent vegetative cover to bare soil is the most efficient and aesthetically pleasing form of long-term erosion control. However, in the short term, immediately after seeding and until vegetation becomes established, the soil remains vulnerable to erosion. This product has created an industry involved in the manufacture of rolled erosion control products (RECP) which are used to mitigate short term erosion and, in some cases, to enhance the long-term

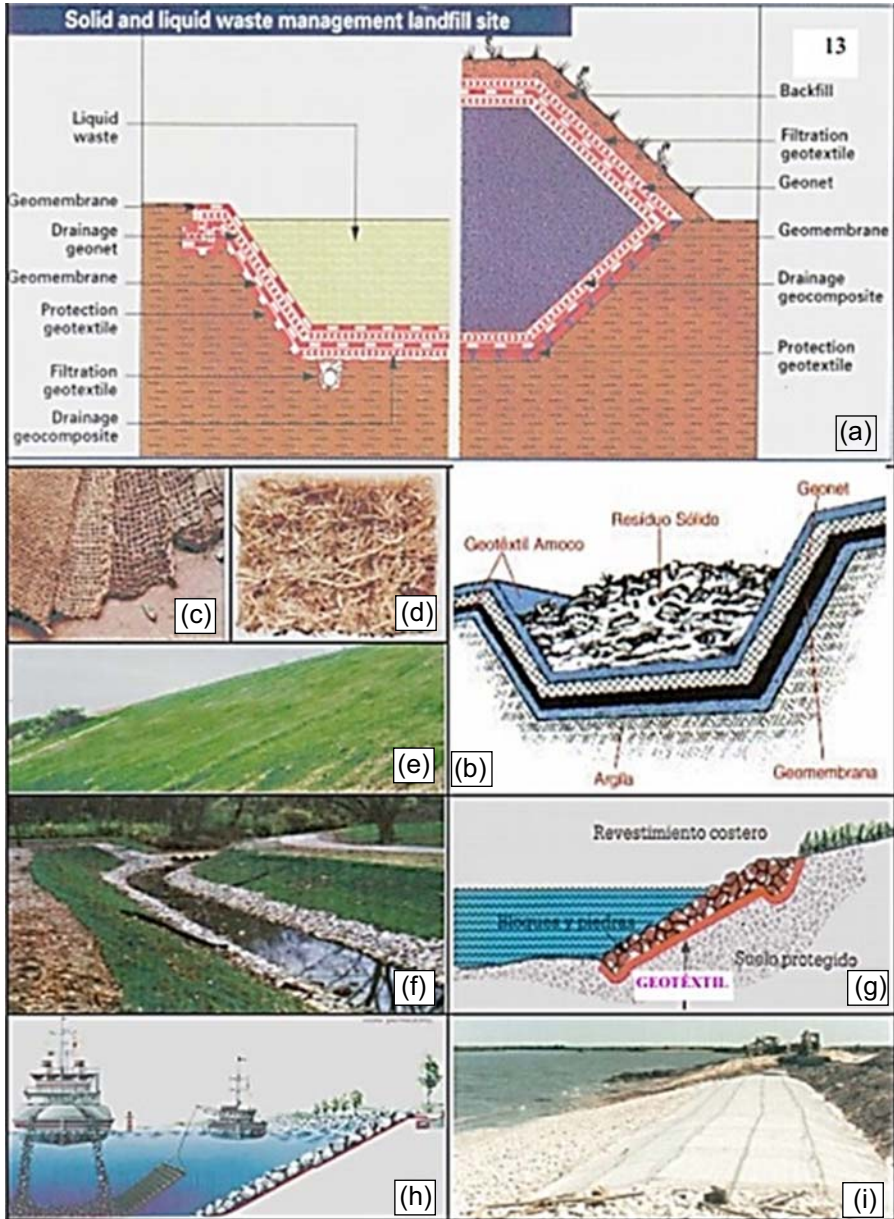

Figure 15.8 Applications of geotextiles as protection function: (a, b) protecting the reservoirs and geomembranes in landfill waste, (c–f) materials and their applications in embankments against erosion, (g–i) situations where protection against erosion in marine works (Ferreira Gomes, 2001).

erosion control performance of established vegetative cover. It is this latter group which is of interest and this group has been sub-classified by the International Erosion Control Association.

RECP cover a diverse range of product structures, including erosion control nets, open weave geotextiles, erosion control blankets or geosynthetic mats, and also commonly used are natural fibres rolls stuffed with straw or coir fibre bundles (fascines, logs, wattles) of various densities, held together by nets from coir twine or synthetics (Leson et al., 2010). Also, an equally diverse range of materials including, wood excelsior, straw, jute, coir, sisal, polyolefins, PVC and nylon. This wide spectrum of structures and materials lead to a confusing array of products which have now been classified by product type and application. Although not yet universally adopted, over the past decade the USA has operated on five product classes, namely erosion control nets (ECN), erosion control meshes (ECM), erosion control blankets (ECB), turf reinforcing mats, or matrices, (TRM) and erosion control re-vegetation mats, (ECRM).

(ii) As a Separator/Separation

These are some forms of aggregate used to form some layer which prevent contamination of one kind of material from another kind of material, called separator. They are used in all classes of roads and similar civil foundation as the base of construction on contaminated layer is the single most cause of premature failure. The use of separator prevents pumping effect created by dynamic load and helps the passage of water while retaining soil particles. In these types of geotextile, thickness and permeability are most important characteristic properties.

With the function of separation is intended to separate the two layers of geotextile different materials in order to avoid contamination, mixing or even your contact. A very typical use of geotextiles in separation is the application in roads, railways, airports and parking lots. This is a very important function on paved roads, especially if performed on soft cohesive soils as demonstrated at Fig. 15.9. Its use prevents the mixing of the subsoil and the materials from landfill to use in works, it is noted that

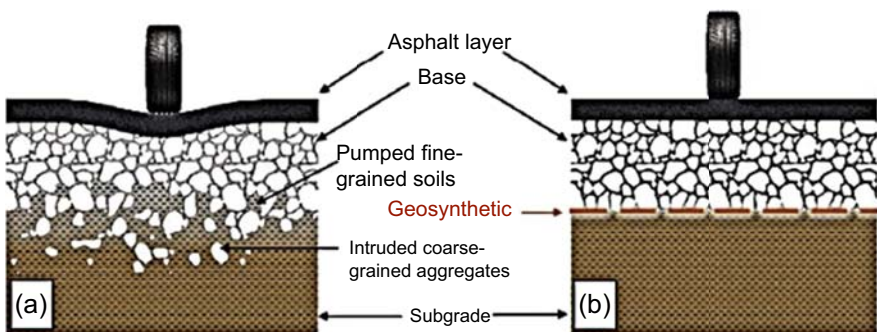

Figure 15.9 Geosynthetic or synthetic geotextile used in separation: (a) roadway designed without geotextile, (b) roadway designed with geotextile.

Reprinted from Zornberg, J.G. Functions and applications of geosynthetics in roadways, Proc. Eng. 189, 298–306, Copyright (2017), with permission from Elsevier.

the main cause of the defects of paved or not, is the contamination of the base consisting of aggregate and the resultant loss of strength from it. The geotextiles provide separation of duties associated with reinforcement and drainage improve the functional characteristics of the track and its durability.

Another very common use as a separator, in combination with drainage, is the application in modern gabion walls, between the stone wall and the filling or natural terrain, thereby allowing soil with fine not penetrate the wall, preventing it from clogging, the resulting increase in hydrostatic pressure in the masonry of the wall and eventually their overthrow.

Uses very frequently as a separator, associated drainage and filtration, is the use in construction of drains classics or in drainages special as it takes place in modern sports areas in which a thin layer of gravel, geotextile between two levels, could help resolve the drainage of football pitches. Another modern use is the application of geotextiles in the construction of green areas and leisure, as shown in some diagrams, controlling the growth of roots, not allowing the contamination of land with inert humus to the land, or even optimizing the consumption of irrigation water. Finally, note that when using encased in protective function, as presented in [Fig. 15.9](#).

With the filtering function is intended that the geotextile, to be left to cross at right angles to the plane, allow the passage of fluid while preventing passage of particles of this soil. Situations of great importance to this function, are the applications in earth dams and drainages in general, in cases where classical filters are used to avoid the drag of thin (piping) particles were carried out on several levels, or rings of sandy soils with different grain sizes. This task is always difficult and requires time consuming to work, that currently there is no need to conduct due to the use of geotextiles ([Veylon et al., 2016](#)).

In filtration, fabrics can be either woven or non-woven, to permit the passage of water while retaining soil particles. Porosity and permeability are the major properties of geotextiles, which involves filtration action. Application helps the replacement of graded aggregate filters by a geotextiles warping. These applications are also suitable for both horizontal and vertical drains.

Important situations in the filter function is the application of geotextiles in the masonry support walls, as well as in sporting areas. Some of application areas are: in place of granular soil filters; beneath stone base for unpaved and paved of roads, railroads, airfields; to filter hydraulic fills; as a silt fence; as a silt curtain; as a flexible form for containing sand, grout or concrete in erosion control systems; as a flexible form for restoring underground mine integrity; around crush stone surrounding under drain, drain pipe; beneath landfill that generate leaching; between backfill soil and voids in retaining walls; as a filter beneath stone riprap; as a filter beneath recast block, etc. The role of a geotextile filter, as with an aggregate filter, is to permit the free through flow of water, without significant long-term loss of soil particles. Flow conditions affect the way in which soil particles interact with each other and with the filter.

Unidirectional flow conditions are where the flow direction remains constant, while there may or may not be changes in the rate of flow. Examples of filters subjected to unidirectional flow are found in: Road-side Drains, Slope Drains, Subgrade Drainage Layers, Wall/Structured Drains, Gabion Walls, Embankment Dams.

Where the flow of water is unidirectional the filter effect is not confined to the geotextile but spreads into the adjacent soil. There is an initial loss of fine soil particles through the geotextile. This loss of fines is greatest adjacent to the filter leaving a zone where the remaining soil particles bridge over the pores in the geotextile. These larger soil particles retain smaller particles. It can be shown theoretically that granular soil particles of diameter 'd' will retain particles of diameter 'd/6' which in turn will retain soil particles of diameter 'd/36'. This results in the development of a stable system, with the formation of a graded filter structure in the soil, adjacent to the geotextile.

Although no longer acting as a filter, the choice of a geotextile is critical to the formation of a stable and effective soil filter. For satisfactory performance, the overall permeability of the soil filter, bridging network and geotextile should always be greater than that of the in situ soil.

The formation of a graded soil filter adjacent to the geotextile is considered to be influenced by three mechanisms:

Blocking - where soil particles on the surface of the geotextile partially or totally obstruct the pore openings; *Blinding* - a type of severe blocking where a cake of fine soil particles forms on the surface of the geotextile; *Clogging* - where soil particles penetrate and are held within the geotextile due to a constriction of the channels; The effectiveness of coir geotextiles in combination with grass to protect steep slopes from erosion in Kerala, South India. In the context of sustainable watershed management, coir geotextile is a cheap and locally available that was used to strengthen traditional earthen bunds or protects the banks of village ponds from erosion (Vishnudas et al., 2006). In this real case, it was demonstrated the effectiveness of coir geotextiles to stabilize banks of hydraulic structures and particularly the steeply sloping banks of a pond (Fig. 15.10). They identified that coir geotextile with grass appeared to be the most effective to prevent erosion, to retain moisture and nutrients and to facilitate grass growth. The degradation of the natural fibres over time was quite interesting since it contributed to the natural fertility producing a well-established vegetation and the geotextile and the bank stability was already achieved when the geotextile was degraded (Vishnudas et al., 2006).

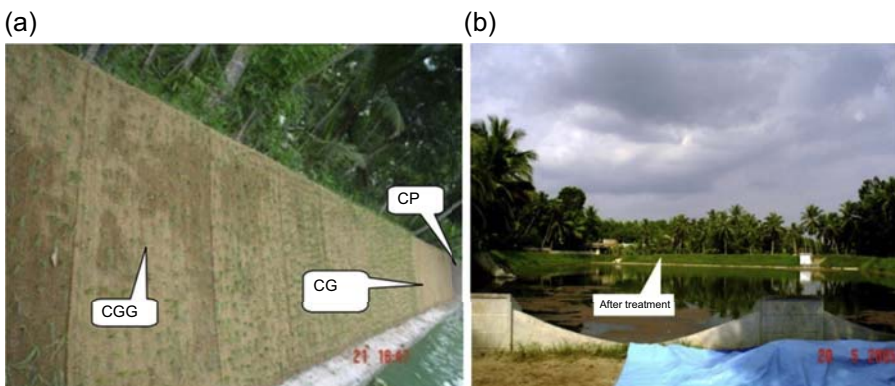

Figure 15.10 (a) Application of geotextile on a side of pond with different treatments and (b) pond after treatment (Vishnudas et al., 2006).

Where the flow of water is multidirectional, the soil filter, which develops adjacent to the geotextile, is repeatedly broken down and built up. This may lead to soil particle loss (eg. erosion behind revetment armour) or mixing of soils (eg. contamination of railway ballast). As a result, the geotextile must physically restrain the movement of soil particles. This leads to a need for stringent permeability criteria (to permit free flow of water without a build-up of hydrostatic pressure) as well as retention and clogging criteria (to prevent excessive piping and clogging).

Geotextile tube breakwaters have been used mainly for flood and water control that can be also a good opportunity of being developed with natural fibres or composites due to their biocompatibility and biodegradability allied to their higher mechanical strength. They are also used as prevention against beach erosion, for shoreline protection, and for containment of contaminated migration (Shin and Oh, 2003). They are more environmentally friendly and less labour intensive when compared to the geosynthetic sand containers. The geotextile tube can be filled with pressurized slurry or fluid, in general made of synthetic sheets. These tubes encapsulating slurry can also work as a filter, due to the fluid flow while retaining the solid particles and should be resistant to water in static and storm waves (Oyegbile and Oyegbile, 2017). An example of geotextile tube acting as breakwaters to attenuate the wave transmission is shown in Fig. 15.11(a) and mitigating the sediment transport in Fig. 15.11(b), as described earlier by (Álvarez et al., 2006; Diaz, 2016).

(iii) Drainage

The removal of water is important to the success of many civil engineering problems. In transportation applications, if the base course does not drain rapidly enough, stress from the traffic loadings is transferred to the subgrade with little or no reduction, resulting in accelerated road failure. The removal of water must be performed in a controlled mode. In recent years, the use of geotextiles as a substitute for graded aggregate in filtration or drainage applications has rapidly increased.

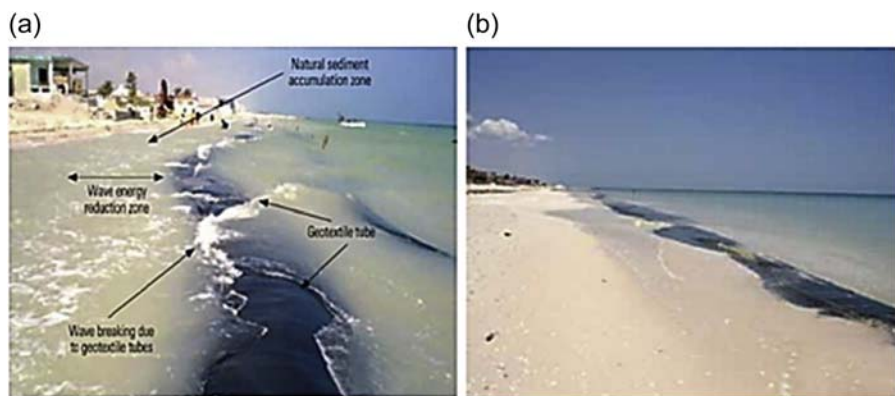

Figure 15.11 Applications of geotextile tube for coastal protection. (a) Geotextile tube inducing wave breaking for energy attenuation; (b) natural sediment accumulation zone showing sand gained shoreward of geotextile tubes (Álvarez et al., 2006).

Otherwise, severe erosion, piping, or settlement of soils may result in undermining adjacent structures. To accomplish this task the drainage system should fulfil two criteria:

1. Have maintained permeability – by providing relatively unimpeded flow of water; and
2. Filtration of base soil – by preventing the migration of soil fines into the drain.

These criteria can be met by using several layers of specially graded aggregates. This often proves to be extremely expensive requirement to meet. The same result can be achieved at a fraction of the cost by using selected geotextiles, which act as filters around the aggregate drainage system. The introduction of geotextile lined drainage systems has enhanced the technical benefits and economical application of blanket and trench drains under and adjacent to pavement structures. The excellent filtration and separation characteristics associated with geotextiles permits the use of a single layer of open graded aggregate base or trench aggregate enveloped in a geotextile.

With the drainage function, it is intended that the geotextile collect and transport the fluids. The drainage can be associated with another functions as having different particles or molecules attached to that. Here, it was highlighted the particular case of geotextile made of natural fibers that has the rule of accelerating the land consolidation.

In foundation engineering, consolidation settlement of salty and muddy soil creates serious problems for construction engineers. The application of various types of drains is to allow accelerated dissipation of pore water pressure by lateral drainage. These drainages are used for stabilization of civil constructions. There are various kinds of drains having their own characteristic properties, these are; sand drain, cardboard drain, wick drain, prefabricated drain and latest innovated banana drain. Ideal drains would have following characteristics:

High permeability to enable rapid dissipation. This permeability must be much higher than that of the ground to be treated and good flexibility to enable large ground movement and not act as a pile and so prevent consolidation. A drain with similar stiffness to soil mass would be best (Abdullah, 2008).

Geotextiles have also been wrapped around free-draining stone or aggregate to form a trench drain channel in drainage applications as illustrated in Fig. 15.12. Because the drainage system is influenced by many factors a wire mesh screen is usually placed underneath the geotextile to support the soil and geotextile specimen. In most of engineering applications, layers of granular particles or space filled with granular particles are placed downstream of the geotextile to act as a protective cushion or drainage channel (Fig. 15.12). Articulated concrete blocks and rip-rap armour stones can also protect geotextiles from being washed out in inland waterways or coastal erosion protection and leave small amounts of open areas for water flow (Wu et al., 2006).

Ideally, the drain needs a good hydraulic connection and a natural or placed permeable blanket layer, which will act as a hydraulic sink, and enable the connection to run continuously over its length. The drain's introduction into the soil should be without any harm or disturbance that would modify its beneficial action as drain. It should be biodegradable and remain functional over the required period, which in most cases is a few months and rarely over a year for the consolidation processes as opposed to

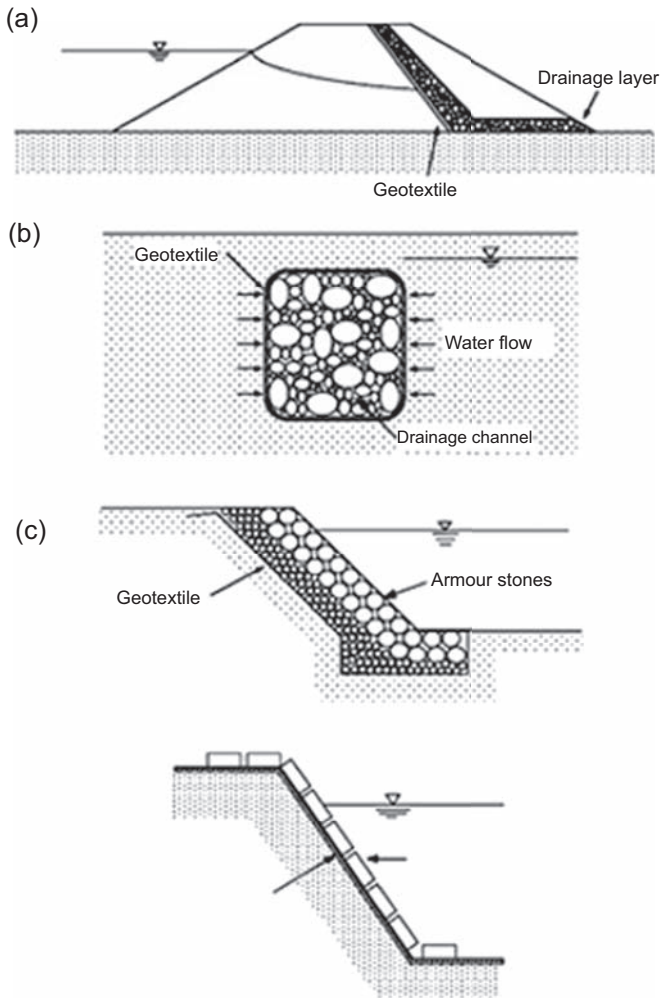

Figure 15.12 Geotextile in filtration and drainage applications. (a) Earth dam, (b) Trench drain, (c) Bank revetment with rip-rap armour stones and (d) Bank revetment with concrete block revetment.

Reprinted from Wu, C.S., Hong, Y.S., Yan, Y.W., Chang, B.S. Soil non-woven geotextile filtration behaviour under contact with drainage materials. *Geotext. Geomembr.* 24/1, 1–10, Copyright (2006), with permission from Elsevier.

permanent drains. A well-designed drain should keep working over various states, usually increasing, of stress, porosity, and permeability, and the textures of the drain body should not be affected by clogging of the surrounding fine soils. The gradient ratio test is one of the methods used in the laboratory to evaluate the clogging potential of a soil–geotextile system ([ASTM D5101 - 01 Standard Test Method for Measuring the Soil-Geotextile System Clogging Potential by the Gradient Ratio, 2001](#)). To reduce

consolidation time, it is obviously necessary to shorten the length of the flow paths. The installation of vertical drains of a high permeability capacity is needed for quick and specific path direction (Abdullah, 2008).

Some of the application areas of these drains are given below:

- i. As a chimney drain in earth dam;
- ii. As a drainage gallery in earth dam;
- iii. As a drainage inceptor for horizontal flow;
- iv. As a drainage blanket beneath a surcharge fill;
- v. As a drain behind a retting wall;
- vi. As a drain beneath railroad ballast;
- vii. Beneath aggregate in unpaved roads;
- viii. Reinforcement of embankment fills and earth dams;
- ix. Repairing slope failures and landslides;
- x. Construction of mattresses for fills over soft soils;
- xi. Water drainage behind retaining walls; and
- xii. Water drainage beneath building foundations.

(iv) Strengthening

With the function of reinforcement, the geotextile uses its ability to tensile to resist tension or restrict deformations in geotechnical structures. The tensile strength allows geotextiles act as armour, improving soil quality, increasing their carrying capacity and stability.

The geotextile acts, to deform as a distributor of loads over a larger surface. The interface properties, including friction between soil and geotextile, ensure a good transmission and distribution of stresses in the environment.

Some applications of geotextiles with the main function of reinforcement are correlated to the building function as dominant in relation to other functions, organized into three major groups: (i) establishment of landfills or any type of pavement on soft soils, (ii) reinforcement of embankments and particularly in construction of embankments and landfill containment works and (iii) the restoration of pavements, interspersed between the geotextile pavement cracked and the new coating.

The geotextile materials are increasingly applied in civil engineering, and particularly in geotechnical works. The ease of application, low cost and versatility of these materials compared to traditional methods and materials, it - building materials attractive, thus justifying the progressive increase of its use. There is, thus, a real explosive growth industry of geotextiles.

In North America, since 1992, in the case of geotextiles, there was a vertiginous development, also similar developments are have happened in Portugal, but lagged about 20 years, since the more common use of geotextiles was found in the last 5 years approximately. Beginning to be common practice teaching on geotextiles in Portuguese universities, and it is expected that during this decade the use of geotextiles in the country shoot in a very explosive. Thus, it is interesting that the national textile industry, accompany such growth; it recalls that the geotextile in the domestic market is, to the knowledge of the author, with foreign production.

15.7.2 Reinforcement of weak soil and other materials

Reinforcement geotextiles are used to form the foundation and reduce the level of stress in the soil by spreading and evening out the stresses. Geotextiles arise as a technical solution in front of traditional methods like vertical drains used to consolidate soft ground that also can have high water content. Therefore, geotextile brings efficiency to this mechanical bearing avoiding failures and it also saves time because of the time spent during soil consolidation in traditional systems. For examples, it would be used for building of a road/any civil construction over soft soils like marshes, swamps, wetland, peat of similar difficult areas. It can also be applied to stabilize dams and embankment. Strength and durability are the major characteristic properties needed for this type of geotextile.

Different configurations can be designed for ground improvement with geotextile reinforcements. One involves the contribution of geotextile for resisting outward shear stress and providing an inward shear stress on the soft ground to improve the bearing capacity of the soft ground or causing a tensioned membrane effect of the geotextile over differentially deforming foundation. This is related to the basal reinforcement that can be temporarily in case, of raw materials for big constructions, that in this aspect it would be highly interesting to use geotextiles made of natural fibres or composites materials that could be used forever.

In case of foundation soil reinforcement, it is required high stiffness geotextiles to improve bearing capacity and reduce differential settlement. The sand layer works as a horizontal drainage blanket to speed up the consolidation process of the foundation soil. Embankment fill was then placed and compacted until the level to install the next layer of geotextile and this process was repeated until the design embankment height was achieved (Yee, 2015).

As described earlier there is two components on the loading from any embankment: one vertical and other horizontal: vertical from the gravity and the lateral comes from the outward shear stress on the foundation due to the earth pressure of the embankment fill, which will contribute to the lowering of the bearing capacity of the foundation (Jewell, 1996). As a consequence, during the geotextile reinforcement mechanism in an embankment of soft ground, the bearing capacity can be improved in two ways (Fig. 15.13(a)). First, the reinforcement may resist the outward shear stress caused by the embankment fill lateral pressure. Second, the reinforcement should reverse the interface shear stress to act inward, increasing the bearing capacity of the foundation (Yee, 2015).

A real application was in 2-km-long causeway embankment over the soft tidal mudflats between Cape Preston and the mainland in Australia was constructed using this geotextile to prevent foundation failures. Subsurface conditions along the causeway comprise an estuarine mud flat underlain primarily by coral that has undergone laterization over bedrock. The soft mud was about 1.5–2 m thick, increasing to about 4 m at the main creek where slope failures was observed along the banks (Kerkovius and Sempel, 2010). Fig. 15.13(b) shows the geotextile reinforced embankment under construction in 2010.

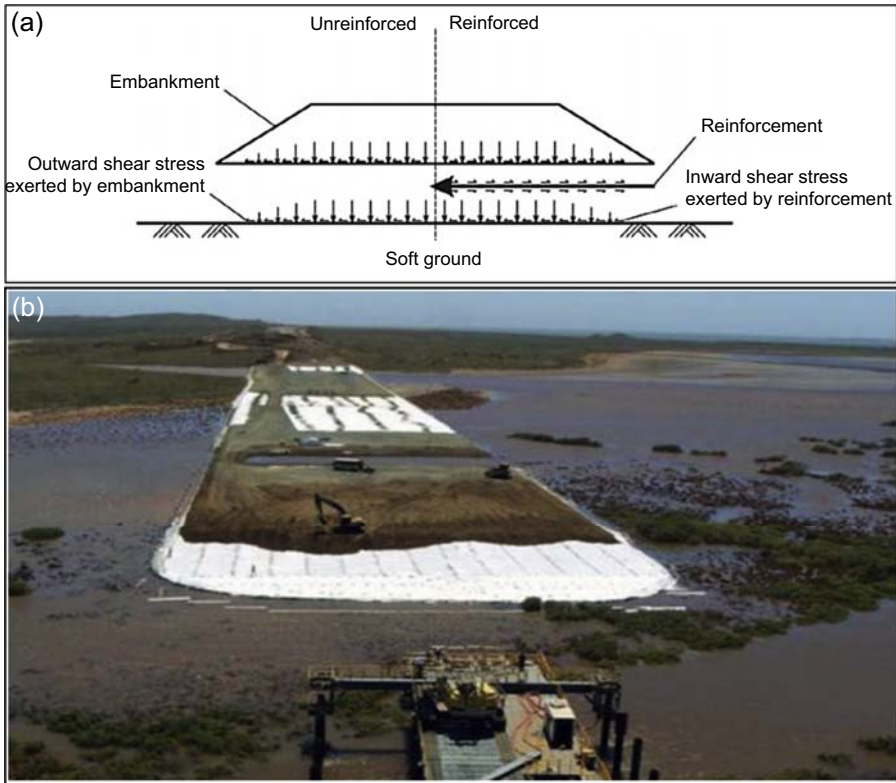

Figure 15.13 (a) A scheme of the reinforcement mechanics of an embankment on soft ground is drawn. (b) A real example where geotextile was used to reinforce embankments at Cape Preston project in Australia (Yee, 2015).

Reprinted from Yee, T.-W. Ground improvement with geotextile reinforcements, *Ground Improvement Case Histories: Compaction, Grouting and Geosynthetics*, vol. 1, pp. 537–558, Copyright (2015), with permission from Elsevier.

Another relevant application of geotextiles can also reduce the thickness of the road-making materials needed and increase the life span of the road along with cost reduction. Few application areas are shown below:

- Over soft soils for unpaved road, airfields, railroad, landfills, sports and athletic fields;
- Over unstable landfills as closure system;
- To warp soils in encapsulated fabric systems;
- To construct fabric-reinforced walls;
- To reinforcement embankment;
- To stabilized slopes temporarily;
- As a substrate for articulated concrete blocks;
- To stabilized unpaved storage yards and staging areas; and
- To soft soils in earth dam construction.

15.7.3 Geotextiles in rural road construction

The use of geotextile products in temporary and rural unpaved road construction is one of their most common uses, and work on them is well established. The basis behind their use is that by placing a geotextile between the weak subgrade soil and the aggregate fill the unpaved road construction will be established. The geotextile will:

- Provide a physical barrier to the intermixing of the aggregate and subgrade soil
- Provide local reinforcement;
- Restrains the sub-grade sub-base from downward and lateral movement in the rut;
- Restrains the subgrade soil from upward and lateral movement between the ruts
- Act as a support membrane;
- Provide sufficient friction to limit lateral sliding of the aggregate;
- Improve the quality of rural roads;
- Increase life span of the road;
- Cost reduction of repair;
- Stands natural climatic events like flood/monsoon destruction; and
- Natural geotextiles like jute geotextiles help balancing eco-system.

15.7.4 Erosion control

Erosion control products are designed to control erosion and cover a diverse range of products which includes; nets, meshes, mats, blankets, both synthetic and natural biodegradable and non-biodegradable are used to mitigate erosion under different conditions, according to short, medium and long term.

In [Fig. 15.14](#), it can be seen the coir geotextile used to avoid erosion on the soil in hill slopes that has proved to be advantageous since it worked as a shielding material against the impact of rain, and wind and helped to keep the seeds in the initial stage of plant growing without being washed away ([Lekha, 2004](#)).

Also, geotextile of jute fibres known as JGT has grown significantly on the world due to their increase on the production and the gradually increasing acceptability among geotechnical and civil engineers due to their technical features and low costs. India has embarked upon designing and engineering JGT geotextile and it was applied on the river bank protection in West Bengal (India) due to both capital investment and recurring maintenance costs by a concomitant agreement among Indian institutions (Department of Jute and Fibre Technology, University of Calcutta, India in collaboration with National Jute Board, Ministry of Textiles, Government of India along with Irrigation and Waterways Department, Government of West Bengal) ([Ghosh et al., 2016](#)).

In order to control the process of erosion, geotextiles must have following properties: reduce rain drop impact; intercept rainfall and run off; reduce wind and run off velocities; store water/water holding capacity; infiltrate surface water; better drapability and compatible to land surface; it should be environmental and ecological friendly; improve soil fertility; and compatible to the application site.

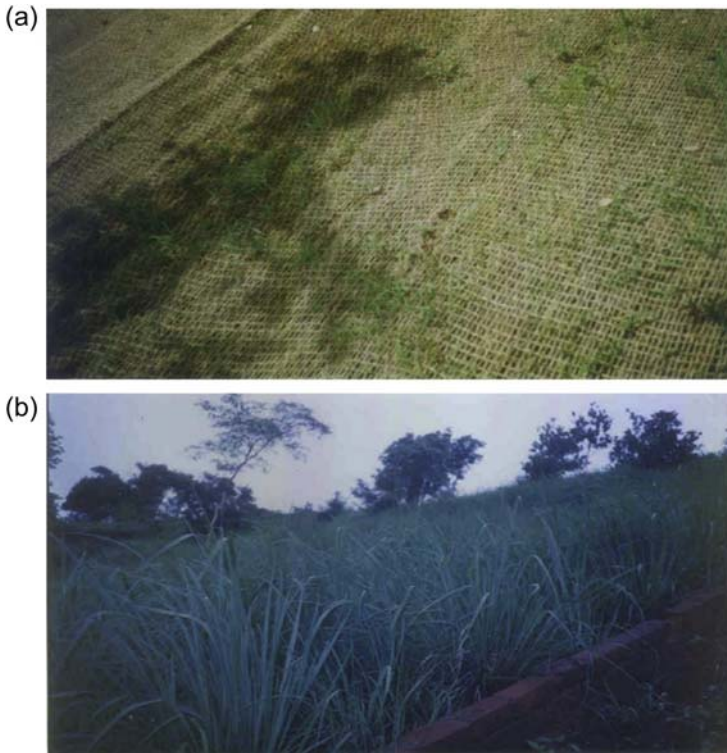

Figure 15.14 Natural Geotextile of coir fibres used for erosion control on the top of hill slopes laid vegetated slope (a) after 1 month and (b) view of the coir geotextile laid vegetated slope after 1 year (Lekha, 2004).

Reprinted from Lekha, K. Field instrumentation and monitoring of soil erosion in coir geotextile stabilised slopes—a case study. *Geotext. Geomembr.* 22/5, 399–413, Copyright (2004), with permission from Elsevier.

15.7.5 Mulching

In agricultural practices, particularly in agronomic/horticultural activities, various fibrous materials are being used from time immemorial for better and effective benefits in producing better crops. Mulches are used to suppress the growth of certain plant species, whilst enhancing the growth of others. Agro mulching is a general term applied to mulches used for agricultural applications and includes traditional loose mulches such as straw. Most application requires suppression of weed growth to reduce competition with the selected or designed vegetation for vital resources such as moisture, light and nutrients.

15.7.6 Moisturizers

Moisturizers are generally from natural fibres. They are fabricated and design so that they have high water holding capacity. High capillaries and hydrogen bonding properties are special properties for these types of geotextile, so that they can provide water

to the plants/crops/land/structure when needed. Important characteristics and functions of these types of geotextiles are to perform:

- Water holding, storing and discharging capacity;
- Protecting soil moisture for facilitating the germination of seed;
- Protecting soil moisture from evaporation and holding heat of the soil facilitating the germination of seed;
- Siphoning water according to the need of plant;
- Facilitating the growth of useful soil microbes;
- Work as weed controller to help the growth of crop/plant; and
- To protect plant from cold/wilting effect.

15.7.7 As a protection of earthquake

Though jute and other fibrous materials were used as a reinforcing material in the construction of mud houses of this part of the world from time immemorial, recently jute and other fibre materials have been identified as an effective raw material for stabilizing various buildings made as of ancient mud houses in Asia and African countries from protection of earthquake.

15.8 Future trends

Geotextiles made of natural fibres are still a developing market that can increase their consumption through the development of new products and applications, or to design a product for a specific application, or in other words, a niche product. Also, it should regain and grow existing markets, primarily erosion control applications, by improving the quality of existing products and providing a stable supply and price structure, which has been done for the sisal, jute and coir fibres.

The market is concentrated in one largest single application, *soil stabilization*, mainly related to roads and highways. The second niche market is in railways, used in similar way where they are applied at the interface of the formation soil and the track bed to minimize pumping of soil fines into the granular material of the track bed. Only in Brazil is estimate a market of 100 million sq./m per year, mainly for the new railroads tracks under construction but still there is no regulation to the use of any geotextile which limits their expansion use in case of Brazil.

The other strategy to enhance the natural fibre geotextile market is to use the LCA (life-cycle assessment) that could be very important for both raw materials, the synthetic fibres versus the natural fibres, including the major commercial fibres and that one's not so known, such as Curaua. The certification is another tool to be considered, including quality, environment, health and safety, hygiene and finally sustainability. Several examples of certification labels can be listed, PEFC, OCCP, Sustainable Forestry Initiative, FSC, Rainforest Alliance, WWF, Bio, Fairtrade, etc.

Existing natural fibre geotextiles do not compete easily with synthetic products in mainstream applications due to its durability, but this can be an advantage in case of applications where biodegradation is important. Meanwhile, recent investigations have

shown that natural fibre geotextile can last longer and also could be inert in forms of composites or nanocomposites. In this way, it is a field that has development potential since the synthetic geotextile is growing considerably with great perspectives due to the all mechanical strength opportunities.

In addition, for the need to be economically and consequently technically viable, natural fibre products would need to fulfil with national standards which specify the geotextiles properties required for various applications.

15.9 Source of further information

More information about obtaining, processing and research of fibrous and herbal raw materials can be seen on The Institute of Natural Fibres and Medicinal Plants. In this website, it can be found also research projects; works for agriculture, environment protection, construction, transport, food and pharmaceutical industries and medicine.

The Company Deyute, that is selling geotextile of jute fibres, shows on their website how they germinate and cultivate the plants until the extraction of the fibres. First, the plants are tied into bundles and then dried to remove the leaves and branches. Later, the bundles are soaked to remove the woody parts from the jute fibres at a temperature of about 30°. This process takes around 3 weeks and it is extremely relevant, since if it is not successful, the fibre will be sticky and it will be difficult to spin. Jute fibres are between 1 and 4 m long and yellowish-white colour, yellow or brown. After drying the fibres, they are folded in half and compressed into bales to be ready for sale (Deyute, 2019). More details about the manufacturing process of natural fibres geotextile such as equipment, stitches and others is found on the article of [Bérubé and Saunier \(2016\)](#). Deyute presents a wide range of jute fabrics in various sectors such as: packaging, textiles, footwear, construction, agricultural, automotive industry, tablecloths, curtain, decoration, gardening, etc. Some manufacturing developments and applications of natural geotextiles are discussed in detail by ([Datye and Gore, 1994](#)). As examples: Design methods for earth retaining crib walls and check dams; non-woven geotextiles for the bases of roads; geotextile used in conjunction with bamboo strip reinforcements connected by synthetic or natural ropes in the cross direction to form grids; linings for ponds and channels, underdrainage for seepage control and drains for soil consolidation; cement coated with natural non-woven geotextile to create a protective layer for the faces of reinforced walls, membranes laid on slopes of storage ponds/reservoirs. Details about the correlation of process and properties for natural fibres geotextiles, fabrics or mats are described in many other articles ([Rawal et al., 2010](#); [Debnath, 2017](#), fabric of the world).

The company KK Enviro offers a wide range of Natural Fibre Geotextiles such as Coir Geocell, Coir Log, Mulch Mat, Weed Control Mat, Tree Mats, Control Blanket, Jute Geotextile Products, etc. While Geotrust established in 2001 in Changzhou, China, its primary focus was geotextile, geotextile tube (geotube). Due to the environmental regulations, Geotrust started the production of small size dewatering bag, silt fence and turf reinforcement mat, soil stabilization geotextile mat and coir erosion control product. Other applications, such as, automotive industry, civil building, water

tanks and latrines for rural areas can be seen at FAO – Food and Agriculture Organization. Some projects involving natural fibres geotextiles can also see on CFC – Common Fund for Commodities.

<https://www.iwnirz.pl/>

<http://www.fabricoftheworld.com/manmade-vs-natural-textile-fibresfabricstextiles-a-fair-comparison/>

<https://www.deyute.com/product/geotextiles-natural-fibers/91>.

<https://www.geotrstgroup.com/coir-products-series/>

<https://www.technicaltextile.net/articles/selection-of-fiber-for-geotextiles-7134>.

<http://www.kkenviro.com/>

<http://www.fao.org/3/ad416e/ad416e10.htm>.

<https://study.com/academy/lesson/woven-vs-non-woven-geotextile-fabric.html>.

<http://www.common-fund.org/?s=geotextiles>.

15.10 Conclusions

Geosynthetic materials made of man-made polymers as well as their applications have been pioneered and promoted in industrially developed countries. It has also been the case of some products of nature fibres which were incidentally manufactured for entirely different purposes. Although the global annual consumption of geosynthetic materials is increasing continuously, the natural fibres geotextiles market can further increase if explored in the right way. It is possible to take it further upward and gain a rightful share for the natural geotextiles in the geosynthetics market provided that the obsession with the biodegradability aspect of natural fibres is overcome, and that various suitable geoengineering materials developed from natural fibres can be developed keeping in view the properties of the raw materials, the functional requirements of the applications and the desired durability of the individual functions specific to each application. As the raw materials are cultivated in large quantities in certain countries and these countries abound in relevant geotechnical problems, their user agencies must play a pro-active role in using suitable geotextiles made of blends of natural fibre and synthetic materials especially in roadways, waterways and land development. The relevant R&D organizations have to adopt a holistic approach and develop suitable geotextiles made from blends of these fibres following methods outlined in this chapter. This would be beneficial not only for the future of natural geotextiles but also for the economy of developing countries bringing employments and consequently stimulation the local economy of the production region.

Acknowledgements

The authors would like to acknowledge the Brazilian Federal Agency for Support and Evaluation of Graduate Education within the Ministry of Education of Brazil (CAPES, by S.F.S. Fellowship).

References

- Geotextiles Market Size & Share. (2019). Industry Analysis Report, 2019–2025. Retrieved from: <https://www.grandviewresearch.com/industry-analysis/geotextiles-industry>. Accessed: 05th September 2019.
- Abdullah, A.B.M., 2008. Jute Geotextiles and Their Applications. Tejgoan, Dhaka. Retrieved from: http://www.namateco.com/attachments/072_JuteGeo-Textile.pdf.
- Adelman, M.J., Weber-Shirk, M.L., Cordero, A.N., Coffey, S.L., Maher, W.J., Guelig, D., et al., 2012. Stacked filters: novel approach to rapid sand filtration. *J. Environ. Eng.* 138 (10), 999–1008. [https://doi.org/10.1061/\(ASCE\)EE.1943-7870.0000562](https://doi.org/10.1061/(ASCE)EE.1943-7870.0000562).
- Álvarez, E., Rubio, R., Ricalde, H., 2006. Shoreline Restored with Geotextile Tubes as Submerged Breakwaters – *Geosynthetics Magazine*, vol. 24. Geosynthetics IFAI Publications, pp. 1–12. Retrieved from: <https://geosyntheticsmagazine.com/2006/06/01/shoreline-restored-with-geotextile-tubes-as-submerged-breakwaters/>.
- Anand, S., 2008. Designer natural fibre geotextiles-a new concept. *Indian J. Fibre Text. Res.* 33. Retrieved from: <http://nopr.niscair.res.in/bitstream/123456789/2023/1/IJFTR33%283%29339-344.pdf>.
- Arun Hegde, 2017. Geotextile Market to Exceed 10 Billion Sq. Meters by 2024: Global Market Insights, Inc. | Markets Insider. Global Market Insider. Retrieved from: <https://markets.businessinsider.com/news/stocks/geotextile-market-to-exceed-10-billion-sq-meters-by-2024-global-market-insights-inc-1006739096>.
- ASTM D5101, 2001. 01 Standard Test Method for Measuring the Soil-Geotextile System Clogging Potential by the Gradient Ratio. West Conshohocken, PA. <https://doi.org/10.1520/D5101-01>.
- Barrett, R.J., 1967. Use of plastic filters in coastal structures. In: *Coastal Engineering 1966*. American Society of Civil Engineers, New York, NY, pp. 1048–1067. <https://doi.org/10.1061/9780872620087.062>.
- Beckham, W.K., Mills, W.H., 1935. Cotton – fabric-reinforced roads. *Eng. News Rec.* 14, 453–455.
- Bérubé, D., Saunier, P., 2016. Manufacturing process of geotextiles. *Geotextiles* 25–60. <https://doi.org/10.1016/B978-0-08-100221-6.00003-6>.
- Chemistry, S.B., 1985. Long vegetable fibres. In: Lewin, M., E., Pearce (Eds.), *Handbook of Fiber Science and Technology*. Marcel Dekker, New York, NY, pp. 505–575.
- Das, S.C., Paul, D., Fahad, M.M., Islam, T., November 2017. Geotextiles-a potential technical textile product. *J. Sci. Eng. Res.* 4 (10), 337–350. Available online: www.jsaer.com.
- Datye, K.R., Gore, V.N., 1994. Application of natural geotextiles and related products. *Geotext. Geomembr.* 13 (6–7), 371–388. [https://doi.org/10.1016/0266-1144\(94\)90003-5](https://doi.org/10.1016/0266-1144(94)90003-5).
- Debnath, S., 2017. Sustainable production and application of natural fibre-based nonwoven. *Sustain. Fibres Text.* 367–391. <https://doi.org/10.1016/B978-0-08-102041-8.00013-5>.
- Diaz, A.H., 2016. Beach restoration of coastal town and shoreline buildings protection to increase tourism using geotextile tubes as breakwaters. In: 3rd Pan American Conference on Geosynthetics, pp. 576–584. Minerva, Loews Miami Beach, Florida, USA.
- Dos Santos, P.S.B., Erdocia, X., Gatto, D.A., Labidi, J., 2016. Bio-oil from base-catalyzed depolymerization of organosolv lignin as an antifungal agent for wood. *Wood Sci. Technol.* 50 (3), 599–615. <https://doi.org/10.1007/s00226-015-0795-8>.
- Ferreira Gomes, L.M., 2001. GEOTÊXTEIS E SUAS APLICAÇÕES. Retrieved from: http://deca.ubi.pt/arquivo/fg_artigos/textos/Geossinteticos/2001_Seminario_UBITEX_Geotexteis.pdf.

- Ghosh, M., November 2009. Suitability of Natural Fibres in Geotextile Applications, pp. 497–501.
- Ghosh, S.K., Sanyal, T., Bhattacharyya, R., 2016. Designing and engineering of jute geotextile (JGT) for river bank protection and its subsequent implementation in river Phulahar. *J. Nat. Fibers* 13 (2), 192–203. <https://doi.org/10.1080/15440478.2015.1004393>.
- Gicot, O., Perfetti, J., 1982. Geotextiles : Conceiving and Designing. Bezons, p. 44.
- Gillon, S.M., MirafTAB, M., 2004. Durability of Recycled Polyethylene for Geotextile Purposes. Retrieved from: http://ubir.bolton.ac.uk/46/1/cmri_conference-3.pdf.
- Hitkari Fibres, n.d. “Technical Textile” Geo-Textiles & Geo-Membranes. Retrieved from: <https://www.technicaltextile.net/articles/geotextiles-geomembranes-2760>. Accessed: 05th September 2019.
- Horrocks, A.R., Anand, S.C. (Eds.), 2000. Handbook of Technical Textiles. Woodhead publishing, Cambridge. Retrieved from: www.woodhead-publishing.com.
- Ingold, T.S., 1994. The Geotextiles and Geomembranes Manual. Retrieved from: <https://www.worldcat.org/title/geotextiles-and-geomembranes-manual/oclc/881853526>.
- Jewell, R.A., 1996. In: Telford, T. (Ed.), Soil Reinforcement with Geotextiles, pp. 237–273. Retrieved from: <http://agris.fao.org/agris-search/search.do?recordID=US201300016528>.
- Kerkovius, A.B.R., Sempel, R., 2010. Design and construction of the Cape Preston causeway and creek bridge over soft tidal mudflats. In: Sydney: 5th Civil Engineering Conference in the Asian Region and Australasian Structural Engineering Conference 2010, pp. 909–917. Retrieved from: <https://search.informit.com.au/documentSummary;dn=848006136080299;res=IELENG>.
- Koerner, R.M., 2016. Geotextiles : From design to Applications. Woodhead Publishing.
- Koerner, R.M., Soong, T.-Y., 2001. Geosynthetic reinforced segmental retaining walls. *Geotext. Geomembr.* 19 (6), 359–386. [https://doi.org/10.1016/S0266-1144\(01\)00012-7](https://doi.org/10.1016/S0266-1144(01)00012-7).
- Leão, A.L., Cherian, B.M., De Souza, S.F., Kozłowski, R.M., Thomas, S., Kottaisamy, M., 2012. Natural fibres for geotextiles. *Handb. Nat. Fibres* 280–311. <https://doi.org/10.1533/9780857095510.2.280>.
- Lekha, K., 2004. Field instrumentation and monitoring of soil erosion in coir geotextile stabilised slopes—a case study. *Geotext. Geomembr.* 22 (5), 399–413. <https://doi.org/10.1016/J.GEOTEXMEM.2003.12.003>.
- Leson, G., Harding, M.V., Dippon, K., 2010. Natural fibres in geotextiles for soil protection and erosion control. In: *Industrial Applications of Natural Fibres*. John Wiley & Sons, Ltd, Chichester, UK, pp. 509–522. <https://doi.org/10.1002/9780470660324.ch21>.
- Mohan, D., Shi, J., Nicholas, D.D., Pittman, C.U., Steele, P.H., Cooper, J.E., 2008. Fungicidal values of bio-oils and their lignin-rich fractions obtained from wood/bark fast pyrolysis. *Chemosphere* 71 (3), 456–465. <https://doi.org/10.1016/j.chemosphere.2007.10.049>.
- Oyegbile, B.O., Oyegbile, B.A., 2017. Applications of geosynthetic membranes in soil stabilization and coastal defence structures. *Int. J. Sustain. Built Environ.* 6 (2), 636–662. <https://doi.org/10.1016/J.IJSBE.2017.04.001>.
- Pritchard, M., S.R.W., A. S. C., 2000. Textiles in civil engineering: Part 2— Natural fibre geotextiles. In: Horrocks, A.R., Anand, S.C. (Eds.), *Handbook of Technical Textiles*. Woodhead Publishing Limited, Cambridge, UK, pp. 372–406. Retrieved from: www.woodhead-publishing.com.
- Rao, A.S., 2003. Jute geotextile application in kakinada port area. In: *Proc. National Seminar on Jute Geotextile & Innovative Jute Products*, pp. 159–163. New Delhi. Retrieved from: [http://jutegeotech.com/html/Jute\(161-203\).pdf](http://jutegeotech.com/html/Jute(161-203).pdf).
- Rawal, A., Shah, T., Anand, S., 2010. Geotextiles: production, properties and performance. *Text. Prog.* 42 (3), 181–226. <https://doi.org/10.1080/00405160903509803>.

- Rawal, A., Shah, T.H., Anand, S.C., 2016. Geotextiles in civil engineering. In: Handbook of Technical Textiles. Elsevier, pp. 111–133. <https://doi.org/10.1016/B978-1-78242-465-9.00004-5>.
- Roul, C., 2009. The International Jute Commodity System – Chhabilendra Roul – Google Books (First Edit). Northern Book Centre, New Delhi.
- Santvoort, G.P. T.M.v., 1994. Geotextiles and Geomembranes in Civil Engineering. Geotextiles and Geomembranes in Civil Engineering. A.A. Balkema. Retrieved from: <https://www.cabdirect.org/cabdirect/abstract/19961904854>.
- Shin, E.C., Oh, Y.I., 2003. Analysis of geotextile tube behaviour by large-scale field model tests. *Geosynth. Int.* 10 (4), 134–141. <https://doi.org/10.1680/gein.2003.10.4.134>.
- Shukla, S.K., 2016. An Introduction to Geosynthetic Engineering – Sanjay Kumar Shukla – Google Books. Taylor & Francis Group, London.
- Souza, S.F., Ferreira, M., Sain, M., Ferreira, M.Z., Pupo, H.F., Cherian, B.M., Leão, A.L., 2015. The use of curaua fibers as reinforcements in composites. In: *Biofiber Reinforcements in Composite Materials*. Elsevier, pp. 700–720. <https://doi.org/10.1533/9781782421276.5.700>.
- Tota-Maharaj, K., Grabowiecki, P., Babatunde, A., Coupe, S.J., 2012. The performance and effectiveness of geotextiles within permeable pavements for treating concentrated storm-water. In: *Sixteenth International Water Technology Conference IWTC*, vol. 16.
- Veldhuijzen van Zanten, R., 1986. *Geotextiles and Geomembranes in Civil Engineering*, first ed. J. Wiley.
- Veylon, G., Stoltz, G., Mériaux, P., Faure, Y.-H., Touze-Foltz, N., 2016. Performance of geotextile filters after 18 years' service in drainage trenches. *Geotext. Geomembr.* 44 (4), 515–533. <https://doi.org/10.1016/J.GEOTEXMEM.2016.02.002>.
- Vishnudas, S., Savenije, H.H.G., Van der Zaag, P., Anil, K.R., Balan, K., 2006. The protective and attractive covering of a vegetated embankment using coir geotextiles. *Hydrol. Earth Syst. Sci.* 10 (4), 565–574. <https://doi.org/10.5194/hess-10-565-2006>.
- Wu, C.-S., Hong, Y.-S., Yan, Y.-W., Chang, B.-S., 2006. Soil-nonwoven geotextile filtration behavior under contact with drainage materials. *Geotext. Geomembr.* 24 (1), 1–10. <https://doi.org/10.1016/J.GEOTEXMEM.2005.09.001>.
- Yee, T.-W., 2015. Ground improvement with geotextile reinforcements. In: *Buddhima Indraratna, C.R., Chu, J. (Eds.), Ground Improvement Case Histories: Compaction, Grouting and Geosynthetics*. Elsevier, pp. 537–558. <https://doi.org/10.1016/B978-0-08-100698-6.00018-0>.
- Zornberg, J.G., 2017. Functions and applications of geosynthetics in roadways. *Proc. Eng.* 189, 298–306. <https://doi.org/10.1016/J.PROENG.2017.05.048>.
- Zornberg, J.G., Gupta, R., 2010. Geosynthetics in pavements: North American contributions. In: *9th International Conference on Geosynthetics*, pp. 379–400. Guarujá, Brazil. Retrieved from: http://www.caee.utexas.edu/prof/zornberg/pdfs/CP/Zornberg_Gupta_2010.pdf.

Properties and applications of ultrafine powders produced from natural fibres

16

Rangam Rajkhowa, Xungai Wang

Deakin University, Institute for Frontier Materials, Geelong, Victoria, Australia

16.1 Introduction

There has been a resurgence of interest in new applications of natural fibres beyond textiles. There is also a growing interest in developing new technologies for value addition to textile wastes. The value addition by recycling gives both environmental and economic benefits. At present, recycling post-consumer textiles is limited to redistribution to less developed regions or extracting the fibres for re-processing into yarns or non-woven products, often in blends with virgin fibres. In this context, milling natural fibres to create organic powder consisting of ultrafine particles is a novel approach and opens up new opportunities. Any fibre can be turned into powder, virgin or used or of any length. To produce powder, pre-consumer soft and hard wastes from the textile industry can be a good source of raw material. The textile industry produces soft waste from processes prior to yarn spinning and very short fibres from the waste cannot be reprocessed and are often discarded. Hard waste from post-spinning, selvedge waste from weaving and garment off cuts are clean but used in low value products. Converting such wastes into powders for new applications therefore create great opportunities for value addition. The possibility of powder production from post-consumer wastes creates even greater opportunity for textile recycling or upcycling. Textiles are one of the fastest growing consumer waste and over 85% of post-consumer textiles end up in landfill. In case of thermoplastic fibres, there is opportunity for recycling by melting and re-processing into new fibres though at present it is only done to a limited extent. There are numerous challenges, including control of spinning dope characteristics to spin good fibres. Natural fibres on the other hand, being non-thermoplastic in nature, are even more difficult to reprocess to produce new fibres, as the process usually requires strong chemicals to prepare the spinning solution or dope. Such processes are often not environment friendly and products are poor in quality. Milling fibres to produce powders opens up exciting opportunities for using natural fibre wastes from various stages of the life cycle. These opportunities not only provide scope for value addition, waste minimization but also facilitate faster biodegradation at the end of life. Natural fibres take a long time for biodegradation but increasing surface area can facilitate faster degradation due to large surface area of the particles.

Fibre particles can be produced by a bottom up approach in which fibres are dissolved into a liquid followed by liquid solid phase transfer to get powder using

different approaches. However, it is not easy to dissolve different types of natural fibres due to the presence of strong hydrogen bonds and high degree of crystallinity. Hence, strong chemicals or expensive solvents are to be used to overcome strong intermolecular forces to solubilize natural fibres. While there has been renewed emphasis on using green solvents to dissolve natural fibres, the process of removing the chemicals from the solution prior to particle production is lengthy and costly. Hence, the bottom up approach of particle production has significant disadvantages. In contrast, a top down approach of milling avoids or minimizes use of harmful chemicals and produces ultrafine particles using mechanical energy only. This approach relies on separating the micro-fibrils present in all organic natural fibres thereby allowing to produce ultrafine particles from fibres of both animal and vegetable origin.

The chapter covers various methods of milling fibres into fine particles and their characterization and applications. The examples presented here are mostly from protein fibres, and more specifically silk, due to extensive research attributed to strong opportunities of their applications in diverse fields, particularly biomedical and healthcare areas. However, silk or wool powder production approach mostly discussed in this chapter can be used for preparation of any other natural fibre powder. The morphological, physical and bulk properties of powders do not vary significantly irrespective of the type of natural fibre. Hence examples presented in this chapter on silk and wool particles related to size and shape, surface morphology, cohesion of particles, flow behaviour etc. are useful to understand powder properties of a wide range of natural fibres.

16.2 Production of natural fibre powder by milling

Milling is a common approach to produce particles from ceramics, metals and other inorganic materials such as pigments and paints. The principles and mechanics of milling used in powder metallurgy and mechanical alloying have been widely studied (Suryanarayana, 2001; Castro et al., 2002; Roderiguez et al., 1997; Frances and Laguerie, 1998; Camerucci and Cavalieri, 1998). Milling in such cases produce ultrafine particles of micron or sub-micron dimensions. On the other hand, in the case of food grains and other agro based products which are mostly organic in nature, milling results in relatively coarse particles of tens of microns. Milling is not common for organic materials such as rubber and viscoelastic polymers including natural fibres. Preparation of ultrafine powder or particle dispersion from such materials remains challenging for reasons discussed in the following section.

16.2.1 Challenges of milling natural fibres

There are three key challenges in producing powders from natural fibres by milling. Common natural fibres, such as cotton, wool, silk, are highly flexible and viscoelastic materials. These fibres do not develop cracks easily and cannot be fragmented like brittle materials such as glass or minerals. It is very difficult to produce fine particles from

natural fibres despite milling for a very long time in their normal form. Even if the fibres are oven dried or desiccated to remove moisture they remain very flexible. Cryogenic grinding has been adapted to produce particles from synthetic polymers by making them brittle using liquid nitrogen. It is either circulated to cool the milling chamber or material is completely immersed in liquid Nitrogen during milling. However, natural fibres do not turn glassy and fragile even at very low temperature and hence cryogenic milling is not very effective in producing ultrafine or sub-micron particles from natural polymers and fibres. Cryogenic milling of wool and cotton have produced particles in the range 60–80 μm (Hassabo et al., 2015). Similarly cryogenic jet milling of chitin produced particles greater than 75 μm (Liang et al., 2002). Moreover, cryogenic process is expensive and has safety issues associated with the handling of liquid nitrogen.

Heat sensitivity of organic materials like natural fibres is another challenge in milling since mechanical energy is converted to heat during milling. Natural fibres are poor conductors and cannot dissipate heat quickly. If milling is continued for a long time, at high temperature, fibres are degraded and turn yellow due to oxidation.

Another challenge associated with milling natural fibre into powder is generation of static charges due to combination of abrasion during milling and poor conductivity of natural fibres. Static electricity causes the particles to stick to the vessel and media and it becomes very hard to remove powder from the milling chamber.

Finally fibres are easily contaminated during milling. Fibres can easily absorb ions and colours from the grinding media, vessel or other parts such as the grinding blades or agitating arm. As the fibres break and particles are formed the surface area is increased and as a result this problem is aggravated. For example, white fibres turn grey after milling if steel containers and steel balls are used while materials such as metal or ceramics can be processed without such a problem.

16.2.2 Pre-treatments of natural fibres for milling

Natural fibres are viscoelastic material consisting of crystalline and amorphous domains. Amorphous domains provide flexibility and if the amorphous part is partly or fully eliminated, fibres become more crystalline and turn brittle. Chemical hydrolysis can break the polymer chains and this happens first in amorphous domains. By controlling the treatment conditions, it is possible to control the degree to which the amorphous domains are removed and the overall crystallinity is enhanced. This can be achieved by acid, alkali, and enzyme treatments. Hydrolysis also reduces molecular weight and thereby fibre strength. Thus hydrolysis produces weak and highly crystalline fibres which are easy to break into fine particles (Rajkhowa et al., 2009). A good example of powder produced from chemically hydrolyzed fibre is Avicel. SEM image of Avicel particles is presented in Fig. 16.1. It is a cellulose powder prepared from wood fibre. Partial hydrolysis is done by 2M HCL at 105°C for about 15 min, which results in dissolution of the amorphous part, leaving a crystalline cellulose. Avicel is used extensively in pharmaceutical products as an excipient. It is also used in cosmetics and as a food thickener or texturizer such as in cheese and peanut butter.

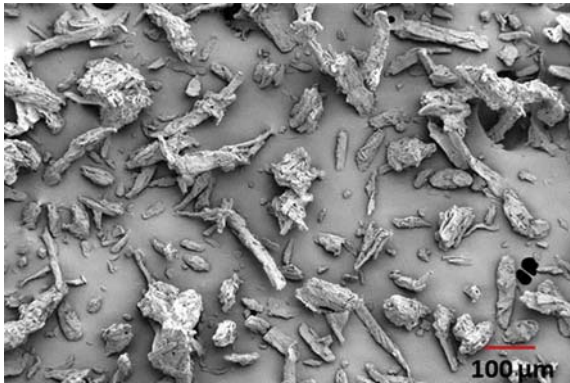

Figure 16.1 SEM image of hydrolyzed cellulose powder prepared from wood fibre (Avicel).

In addition to chemical pre-treatments, other pre-treatments such as high temperature and high energy radiation can be used for reducing fibre strength and making fibres brittle to facilitate milling (Ha and Lim, 2001; Shida and Hidefumi, 2001; Hidefumi et al., 2000). For example, high energy gamma irradiation substantially reduced the strength of silk fibres from about 4 g/den to 1–2 g/den. It resulted in improved efficiency for ball milling of silk. As a result particles with median size of 10 μm could be achieved in 1 h milling which otherwise takes a significantly longer time. The approach is suitable for other natural fibres such as wool and down feather (Xu et al., 2004, 2009).

In case of significant hydrolysis, fibrous polymers turn into oligomers and in that form they become soluble in water. Once acid or alkali hydrolysis turns fibres into a soluble form, the acid/alkali is to be neutralized and salts and residual chemicals have to be removed by various means such as ultrafiltration. The resultant aqueous solution can be spray dried into low molecular weight powder (Kang et al., 2002; Lu et al., 1996; Yasuda, 1996; Kim et al., 2001). Hydrolysis of proteins fibres such as silk can turn high molecular weight polymer chains into peptides or simple amino acids and produce peptide or amino acid powder. Molecular weight can be reduced also by using high temperature and pressure (Gyung-Don et al., 2002). Hydrolysis and thermal degradation during low molecular weight powder production can change the colour of powders, and ion-exchange resin or activated charcoal has been used to improve powder colour (Gyung-Don et al., 2002; Chen et al., 1992). Such water soluble peptide or amino acid powders are used for edible or cosmetic applications.

16.2.3 Methods of milling natural fibres

Milling natural fibre into ultrafine particles by overcoming the challenges has been reported particularly for silk and wool using selected media and non-media milling methods. Milling methods can be divided into two broad categories, media milling and non-media milling depending on uses of media (balls or beads). In a media mill, size reduction of materials takes place due to impact and shearing actions of balls

known as media. The balls are agitated inside a vessel. The impact force is generated due to collision between balls, or balls and the vessel wall. Shearing of milled materials happens due to sliding of balls between each other and with the vessel wall (Castro et al., 2002). The intensity of milling depends on size and density of media, type of agitation and speed of media. Media milling is an effective size reduction approach but also comes with the problem of contamination of material from gradual abrasion of milling media. The general rule of media milling is to use large size media for initial milling when particles are large. Large particles require strong impact force for size reduction and large balls with high mass provide the required impact force. Ball mills and stirred media mills are commonly used media mills for natural fibre milling.

In the case of non-media milling, there are no media or balls and grinding happens due to impact of the blades (rotary mills), action of compressed air (air jet mill) or cutting actions of blades. The major advantage of non-media mills compared to media milling lies in zero or limited contamination. However, non-media mills are not very effective particularly at the initial stage of size reduction of natural fibres as the fibres are not brittle material so strong impact does not help in size reduction. The non-media mills used for natural fibre powder production include Cutter mills, Air jet mills and Pan mills.

16.2.3.1 Type of non-media mills

Cutter mill

First step of making fibre powder is reducing the size of the fibres by a cutter mill. A cutter mill has a rotor fixed with several blades and the fibres are cut between the rotor and fixed blades. The chopped snippets are repeatedly cut until they pass through a grid where the size of the grid may vary from 0.2 to 5 mm or more. Often fibres longer than the holes in the grid can pass through since fibre diameter is much smaller than the grid size. Fibre length distribution of the snippets can therefore be wide. In a cutter mill, fibre length is only reduced by the cutting action of the blades and there is hardly any fragmentation from impact or abrasion in the process. This mill can be used to prepare snippets from fibres, yarns or fabrics. In the case of fabrics, small pieces are fed into the machine. Examples of snippets prepared from cotton fabric and degummed silk fibre using a cutter mill with 0.2 and 1 mm grids respectively are presented in Fig. 16.2. It is clear that all cut fibres are not equal in length as some fibres are circulated within the cutter mill and cut more than the others before passing through the grid. The fibre snippets produced by a cutter mill are then processed through another mill or a combination of mills to produce powder.

Air jet mill

In this case, milling is caused by impact between particles due to rapid movement of material assisted by high pressure air. There is no media and associated friction of media and hence heat generation is limited in a jet mill. Moreover, compressed air produces the Thomson cooling effect and thus keeps the product temperature low. Therefore there is no chance for thermal degradation of particles (Palaniandy et al., 2006). Lack of contamination from media or moving parts and absence of oxidative

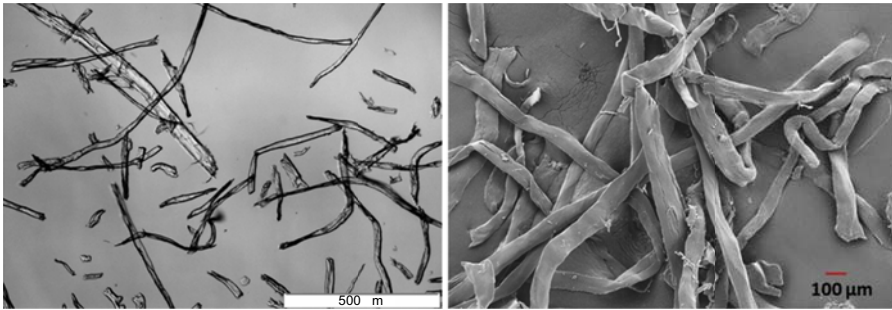

Figure 16.2 Optical microscopy image of cotton snippets prepared using 0.2 mm grid (left image) and SEM image of silk prepared using 1 mm grid (right image).

thermal degradation ensure that there is no change in the colour of the powder. However, air jet milling is not effective to grind viscoelastic natural fibre snippets as it is effective only for milling brittle materials by impact energy. To improve size reduction, jet milling under cryogenic conditions can be helpful as the materials, particularly polymers become brittle at a low temperature (Liang et al., 2002). However, there is limited success of cryogenic milling in case of natural fibre powder production without pre-treatment. If brittleness is increased and the strength of fibres is reduced by acid or alkali hydrolysis, then air jet milling becomes a viable option to produce fine powder directly from snippets of natural fibres. Air jet mill is also effective as a final stage of milling to break aggregates of ultrafine particles prepared by other methods of milling.

Pan mill

This mill also called stone mill is a traditional non-media mill. Two pans rotate in different directions and abrasion of material between two pans causes breakdown of materials into particles. This type of mill is used widely for food grains. It was used to produce wool powder in which fibre snippets were milled into small particles but wool was to be first oxidized with 0.5% NaClO and grinding was done in moist condition (Xu et al., 2004).

16.2.3.2 Type of media mills

Shaker mills

Shaker mills are high energy mills that operate with fine milling media. A grinding vial containing the material and the grinding media swing energetically back and forth several thousand times a minute. Usually the media used is 1 mm or less and milling is performed in wet form where the material is suspended in a liquid, often water. These types of mills are used to produce ultrafine or nano-size particles from already milled fine particles.

Ball mills

Ball milling is a commonly used dry milling process in which the milling vessel rotates to provide agitation to the media. A variation of this is the planetary ball mill where the

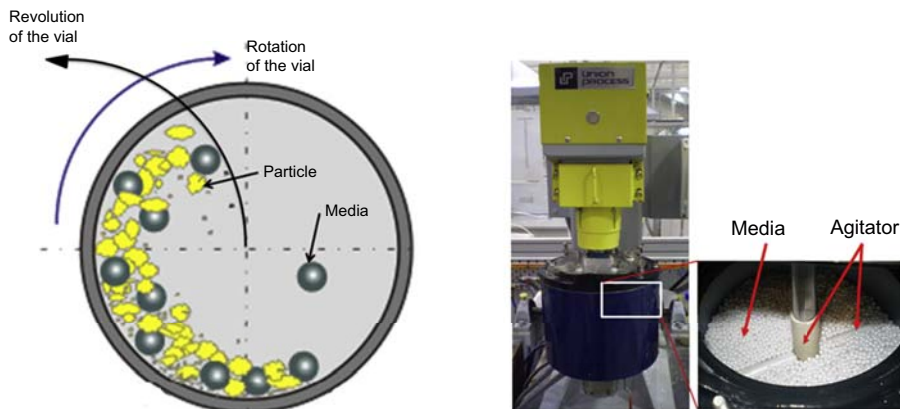

Figure 16.3 Schematic of a planetary ball mill (Suryanarayana, 2001) (left) and photo of a stirred media mill (Right).

vials have planet-like movements as they rotate as well as revolve (Fig. 16.3). The centrifugal force acts on the samples and the grinding balls inside the vials. In addition to the impact from the media, the sliding of the media against each other and against the vial wall results in shearing forces on the material, which along with impact forces, helps size reduction. Ball milling of natural fibre snippets to produce ultrafine powder takes a very long time. Sano et al., 1998 in their US patent claimed achieving particles with an average size of $\sim 20 \mu\text{m}$ in 12 h of ball milling and further milling was not effective to reduce the particle size. They used air jet milling following ball milling to reduce the average particle size to $3.2 \mu\text{m}$. There are also reports of up to 48 h ball milling followed by jet milling to produce an average silk particle diameter of $5.6 \mu\text{m}$ (Oyama, 2006). Similarly in the case of planetary ball milling of silk snippets, it took more than 18 h to get median particle size of $d(0.5)$ below $30 \mu\text{m}$ using 10 mm balls with fibre to ball weight ratio of 1:30. However $d(0.5)$ could be reduced to below $20 \mu\text{m}$ if fibres were moistened during milling (Rajkhowa et al., 2008).

Stirred media mills (attritors)

Stirred media mills are used for both dry and wet milling. Unlike a rotating container in a ball mill, here the vessel is stationary and media is stirred by a rotating shaft with arms inside exerting both shearing and impact forces on the material (Fig. 16.3). Attritor is an example of a stirred media mill and commonly uses 2–10 mm media. Stirred media mills are suitable for ultrafine and nano-particle production and used widely in the ceramic, food and chemical industry for such things as pigments and paints (Castro et al., 2002; Liu et al., 2006; Kwade, 2005; Stenger et al., 2005). Attritor milling can be a batch process, a semi-continuous process where material to be milled is circulated, or a continuous process where material is passed continuously through the vigorously agitated media. Wet milling in a stirred media mill is the preferred method for natural fibre milling. However, natural fibre snippets in the early stage of milling do not form a homogeneous slurry and therefore are difficult to be pumped. Pumpable slurry is

formed only after the snippets are fragmented to fine particles. Hence, material cannot be circulated and hence batch process is only effective for fibres. In a stirred media mill, as the tank is stationary, coolant can be circulated through the jacket to control the temperature of the milled material which is a great advantage for natural fibres. The shearing action of media in this mill is significant and therefore this mill is very effective for natural fibre powder production. Wet attritor milling has been successfully used in milling different natural fibres (Rajkhowa et al., 2008, 2012a; Patil et al., 2012a). In an attritor fragmented particles during milling form a colloidal type of suspension in water. This colloidal suspension can be spray dried to recover the particles in the form of powder.

Fine stirred media mills (bead mills)

The bead mill performs wet milling and uses very fine media of 1 mm or less. Slurry is circulated continuously through the milling chamber where beads are agitated by a rotor. Bead mills cannot be used at an early stage of milling as the impact energy of the fine media is not adequate to fracture large particles. Moreover, the slurry should be pumpable and particles should pass through the fine grid used to retain the media inside the milling chamber. Bead milling is used as a final step in size reduction after the particles are already reduced to micron size in previous milling steps such as in attritor milling.

Once particle size is reduced to sub-micron scale during bead milling, aggregation becomes a major problem and extremely fine beads of less than 1 mm also cannot prevent aggregation of particles. The aggregation depends also on particle zeta potential (surface charge) as surface charge can prevent particles from coming closer to each other. For example, when pH of the protein particles is close to their isoelectric point, such as pH 5.5 in the case of wool, the aggregation is severe as there is very little charge on the particle surface. In such a situation, adjusting the zeta potential by changing the pH to add more surface charge can assist milling. Good dispersion of particles is also important for spray drying of milled slurry to recover powder. Hence, acid or alkali s used to drive zeta potential away from an isoelectric point to induce surface charge (positive or negative depending on pH). Surfactant can also assist to reduce aggregation of sub-micron particles (Kazemimostaghim et al., 2013a, 2013b).

16.2.3.3 Advantage of wet milling of natural fibres

The milling can be carried out in either a dry state or a wet state depending on the type of mill used. For natural fibres, wet milling is preferred to overcome challenges of thermal degradation and to avoid generation of static charge. Water used in wet milling can control temperature rise and therefore reduce thermal degradation. Most importantly, size reduction of natural fibres is much faster in wet milling as water breaks the hydrogen bonds present in most natural fibres. Abrasion action during milling in wet condition can cause significant fibrillation. Fig. 16.4(a) shows an image of fibrillated silk fibres in early stage of wet attritor milling. The micro-fibrils separated by abrasion can be subsequently fractured to create particles (Fig. 16.4(b)). A comparative study between dry and wet ball milling has shown that while it takes 18 h for silk

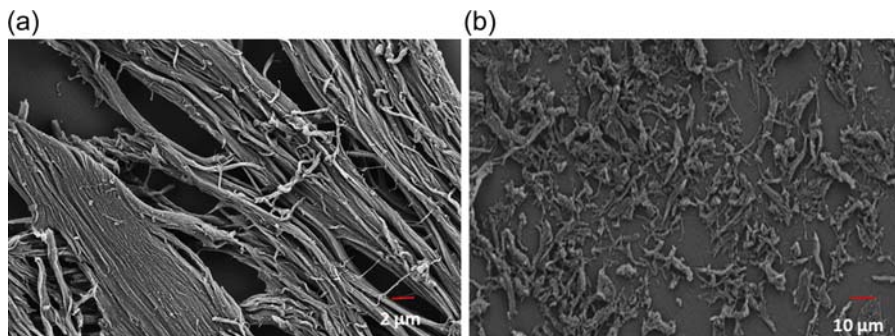

Figure 16.4 Fibrillation of natural fibre (a) and fragments of fibrils (b) during wet milling in an attritor

snippets to reach a median particle size below 30 µm in dry milling, the same snippets can be wet milled to below 20 µm in less than 5 h. The experiment was conducted in a planetary ball mill using 10 mm media and fibre snippets to media weight ratio of 1:30 (Rajkhowa et al., 2008). In the case of wet stirred media milling, the median size of particles with median size of 5 µm can be achieved in less than 6 h.

To improve size reduction in dry milling, addition of a small amount of water but still maintaining dry form of the material can be helpful. Water assists faster size reduction while unlike wet milling there is no need for subsequent drying to recover powder from slurry. To avoid aggregation of ultrafine particles and improve powder flow for better discharge from the milling chamber, a dry lubricant commonly known as a process control agent (PCA) can be used in dry milling. Steric acid and polyethylene glycol are examples that have been successfully tried during dry milling of natural fibre powder to reduce milling time (Rajkhowa et al., 2009).

16.2.3.4 Obtaining powder after wet milling

In case of wet milling small particles are slowly dispersed in water. Once milling continues, the ultrafine particles in the slurry form a colloidal suspension. Particles have to be recovered in dry form to get powder. The drying process can significantly change size of particles as aggregates are formed during drying. The particles stick to each other due to the formation of strong hydrogen bonds as they dry and it is difficult to separate individual ultrafine particles. Even freeze drying can be responsible for substantial aggregation and the average particle size increases after drying.

Spray drying is an effective process to dry particles to produce natural fibre powder with ultrafine particles. Spray drying is commonly used to get powder from a solution but the process can be used also for drying particles from a particle dispersion. The solution/dispersion is atomized when passed through a pressure nozzle of a spray dryer. The mist is sprayed into a hot air chamber and inside the chamber the water quickly evaporates, leaving behind the dry particles. The sprayed droplets are moved by an air current as particles dry and hence there is limited chance for particles from different droplets to aggregate until water is completely removed. Particles are

recovered from air using a cyclone. Spray drying a suspension with larger particles is difficult as large particles block the spray dryer nozzle. In addition, the suspension stability of slurry with large particles is poor making it difficult to pump the slurry into the spray dryer. It is noticed that in the case of natural fibres particles, a dispersion with median particle size of about 10 μm or less can be spray dried without much difficulty.

16.2.3.5 *Process parameters in milling*

The mechanism of fracture of different natural fibres is similar but due to their differences in morphology and mechanical properties, the selection of process parameters in milling has to be based on individual fibre type. The kinetics of size reduction, particle size, properties of milled material, and contamination from milling depend on multiple factors. These include type of mill (Suryanarayana, 2001), type and hardness of media and milling container (Suryanarayana, 2001), milling speed (Suryanarayana, 2001; Camerucci and Cavalieri, 1998; Kwade, 2005; Stenger et al., 2005), and milling time (Suryanarayana, 2001; Camerucci and Cavalieri, 1998). Moreover, size and size distribution of the milling media is important and selection should be based on type of materials milled and size reduction desired (Liu et al., 2006; Kwade, 2005; Stenger et al., 2005; Cintas et al., 2005). Other influencing parameters are, extent of vial filling (Suryanarayana, 2001), type of liquid (Watson et al., 1998), solid content in the slurry (in the case of wet milling only) (Frances and Laguerie, 1998; Camerucci and Cavalieri, 1998; Liu et al., 2006; Kwade, 2005; Stenger et al., 2005), type of process control agent (PCA)/dispersants (Suryanarayana, 2001; Liu et al., 2006). Amongst different factors, the vial, media, and the PCA are the possible sources of contamination in media milling (Suryanarayana, 2001; Castro et al., 2002).

At the start of milling, as the particles are large, the fracture rate is high. However, once the particles become small, their fracture resistance is increased and particle fineness approaches a limit (Castro et al., 2002). There is also an increase in the degree of aggregation of particles as they become finer due to increase in surface cohesive energy as a result of higher surface area. Colliding media further helps in the welding or aggregation of particles. Therefore in all cases of milling after a certain amount of time, a steady state is reached when no more particle size reduction takes place and size may increase if milling continues due to aggregation. The time to reach the minimum achievable particle size is often decided by the type of material but also depends on the milling process parameters as well as media size. Once minimum particle size is achieved, to further reduce particle size, finer media with a large surface area is required. Higher surface area of finer media is helpful to break the aggregates. However, the fine media has low energy of collision due to low mass and thus cannot be used at the start of milling when material to be fragmented is already large.

16.2.3.6 *Explosion risks of fibre powders*

Combustible materials in powder form have explosion risks and the risks increase with reduction in powder size. There may be risk of explosion from organic powder such as wood dust if allowed to accumulate in the production environment and exposed to

flames. Natural fibres can catch fire and level of risk depends on the type of fibre. Protein fibres such as wool and silk inherently burn slowly so their explosion risk is low, but increase in surface area can increase the fire propagation. Fibre powders are usually produced and handled like pharmaceutical grade powder and production environment is enclosed such as in spray drying and air jet milling. Powders are collected inside containers in the production process. Moreover wet milling avoids dry powder handling and therefore is advantageous for eliminating risks associated with explosion.

The explosion risk also depends on the moisture content in the powder. The relationship between dust explosivity, moisture sorption and natural fibre chemistry has not been investigated to identify safety issues and assess explosion risks of natural fibre powder materials. Some information on cellulose derived powders is available which suggests the humidity and moisture in the material play an important role. Material safety data sheet of pure cellulose powder suggests that accumulation of settled dust may form explosive concentrations in air when disturbed and dispersed. According to NFPA 68 (Explosion Venting Guide), the Hazard Class of Dust Deflagrations for Alpha Cellulose is St-1, the lowest hazard class. However any powder production and application methods should have adequate control to eliminate dust in the air and built up of particles in the production work area. There is scope for further research into safety aspects of organic fibre powders as such aspects have not been investigated thoroughly to date. This will help maintain production and storage conditions to mitigate any explosion risks.

16.3 Powder characterization

16.3.1 Particle size and morphology

The particle size distribution plays an important role in powder properties and applications. Size distribution is measured either using a number or a volume based approach. In the number based size distribution, a large number of very fine particles representing a small percentage of volume significantly skew the plot to the finer side. Hence volume based distribution is a better approach to measure size, particularly when the size distribution is broad. The laser diffraction method is commonly used for particle size measurement. In this measurement the equivalent size of a sphere is calculated by the instrument software based on scattered light from the particles. There are also instruments where particle images are taken by high resolution digital cameras to calculate size of particles and measure aspect ratio of particles. This is useful if particles are not spherical. However the resolution of cameras is often not good enough to measure size of ultrafine particles.

An example of changes in particle size distribution plot during milling is presented in Fig. 16.5. The wool snippets of tens of microns were converted to ultrafine particles of a few microns in 5 h milling. The slurry after 3 h milling produced a bell shaped distribution with an average particle size below 10 μm . A milled slurry with such a size distribution can be spray dried to get fine powder. There is a small increase in

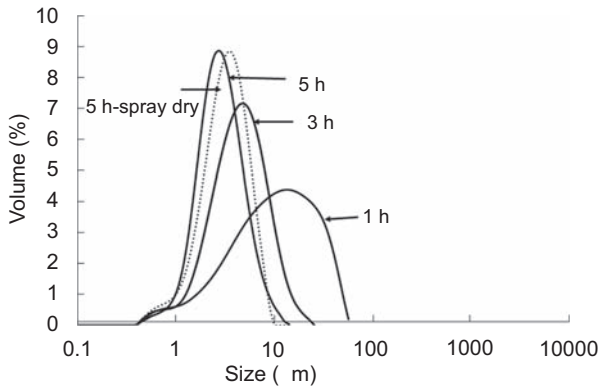

Figure 16.5 Size distribution plots of wool during wet milling and spray drying.

size of the particles as reflected in a small shift of the size distribution plot of 5 h milled slurry after spray drying, due to assembly of particles within sprayed droplets.

The images of the spray dried particles following wet attritor milling are presented in Fig. 16.6. The natural fibre fragments in the slurry produced by milling are not spherical as shown in Fig. 16.4(b), but spray drying produces almost spherical morphology as a result of assembly of finer particles in sprayed droplets (Fig. 16.6). The morphology of such particles is useful for applications where particle flow and feel are important such as in cosmetics. Fig. 16.6 shows that after 3 h milling fibrous fragments can be seen in particles. As the milling continues, the fragments become

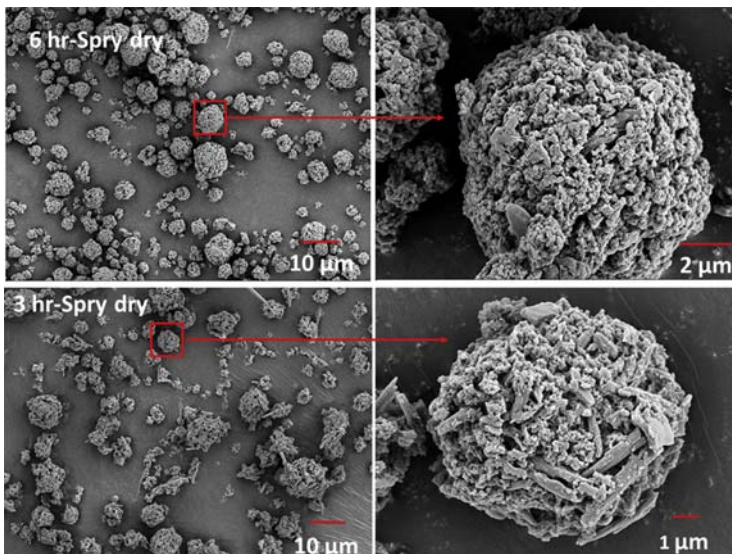

Figure 16.6 SEM images of wet milled and spray dried wool powder.

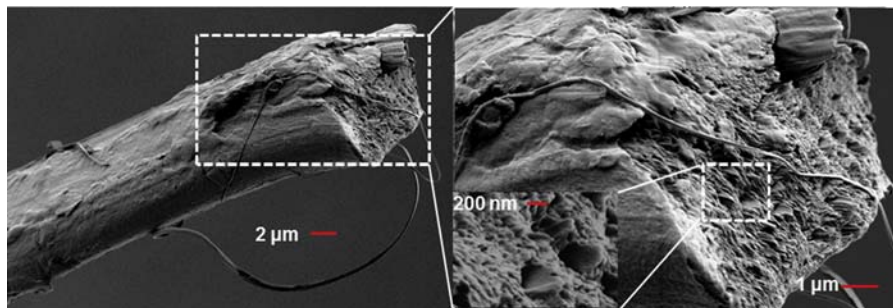

Figure 16.7 Morphology of fractured surface of a natural fibre (example: silk) (Rajkhowa et al., 2015a).

smaller in the slurry and the particle aspect ratio decreases. The overall size and shape of spray dried particles prepared from 3 to 6 h milling are not much different as spray drying conditions mostly determine the size of droplets. However, the 6 h milled and spray dried particles do not have the fibrous fragments since they were fragmented due to additional milling.

The spray dried particles have a cauliflower like granular surface morphology. The globules in the particles are considered to be the ruptured tips of the micro-fibrils present in all natural fibres. Similar globular surface morphology is seen in fractured surface of any natural fibre such as fractured silk as shown in Fig. 16.7.

The surface morphology of powder prepared from hydrolyzed fibre is very different as the granular morphology is absent. The example of milled and spray dried particle from alkali hydrolyzed silk fibre is shown in Fig. 16.8. The hydrolyzed fibres have reduced amorphous content and become brittle due to loss of the flexible amorphous domain. Repeated collision of brittle crystalline fibres ultimately creates a very smooth surface (Fig. 16.8, left image). The surface image of milled powder from the same silk fibres prepared without alkali hydrolysis is presented where the typical granular surface morphology can be clearly seen (Fig. 16.8, right image).

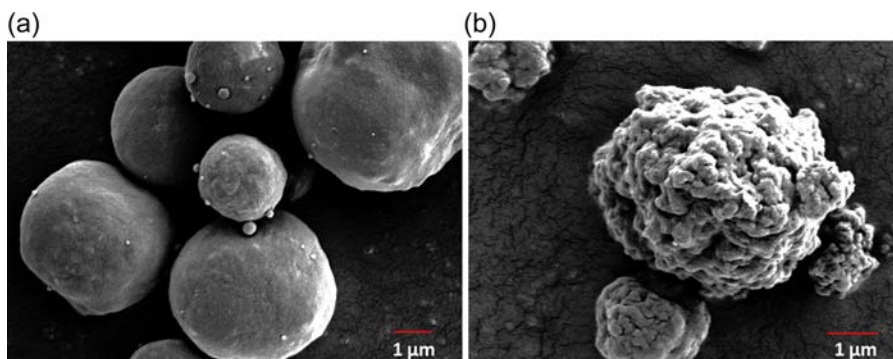

Figure 16.8 (a): Surface morphology of natural fibre powder prepared from hydrolyzed silk (left) and (b): non-hydrolyzed silk (right).

16.3.2 Size and morphology of sub-micron particles

The production of sub-micron particles is usually achieved using two stage milling. Initial attritor milling with 5–6 mm media produces particles with a d.5 of about 5 μm and then final state of bead milling can achieve d.5 of about 300 nm with very fine media of 1 mm or less. SEM image of sub-micron silk particles along with particle size distribution plot prepared in a bead mill with 0.8 mm media is presented in Fig. 16.9. Spray drying of colloidal slurry containing sub-micron particles yields micron scale particles as shown in Fig. 16.10(a). Size of the particles depends also on spray drying conditions and there is a limit to droplet size that can be formed in spray drying. Many sub-micron particles assemble within a single spray droplet and form an aggregate during drying as shown in Fig. 16.10(b). Further air jet milling can assist to obtain powder with individual sub-micron particles by separating the nano-scale particles from the aggregates as shown in Fig. 16.10(c).

16.3.3 Surface area of particles

Surface area is an important parameter which affects many powder properties such as cohesion, flow, bulk density, absorption, reactivity and enzymatic degradation of particles. The common measurement of surface area is specific surface area which is the surface area per unit mass. Surface area of fibre particles is difficult to calculate from physical dimensions as milled particles are not perfect spheres and often have complicated shapes. Surface area is experimentally measured using the Brunauer–Emmett–Teller (BET) theory of gas adsorption. Nitrogen is the most commonly used probe due to its inert nature and small atomic size.

Surface area is significantly affected by particle morphology. Particles from hydrolyzed silk fibre with d(0.5) of about 5 μm and smooth surface morphology, as shown in Fig. 16.8(a), are found to have a BET surface area of 4.4–6.4 m^2/g . On the other hand similar sized particles from fibres without hydrolysis (Fig. 16.8(b)) have a BET surface area of 18.4–19.9 m^2/g (Rajkhowa et al., 2015b). Considering the density of natural

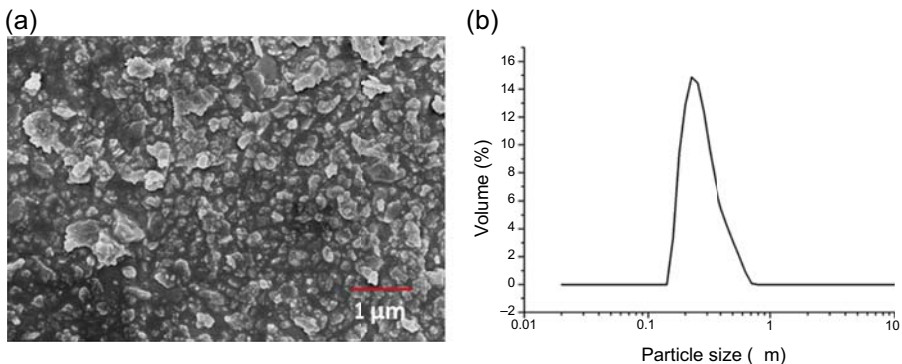

Figure 16.9 SEM image of bead milled sub-micron parties and size distribution plot.

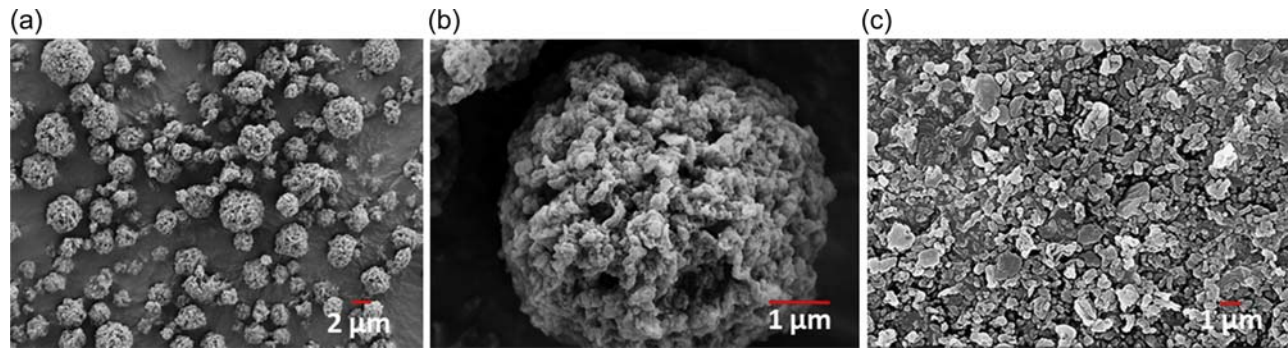

Figure 16.10 (a, b): Spray dried particles from sub-micron bead mill dispersion; (c): same powder after air Jet milling.

fibres, only solid spheres of diameter of 0.2–0.3 μm should have such a high surface area. The high surface area is attributed to the granular surface morphology and aggregated form of sub-micron particles. The nitrogen gas used in BET surface area measurement can probe the surfaces of the primary particles in the aggregates providing a high surface area. After air jet milling the particle aggregates are separated resulting in substantial reduction in particle size, but there is only a marginal increase in BET surface area. For example, in silk particles, BET surface area increased from 18.6 m^2/g to 21.2 m^2/g when $d(0.5)$ changed from 5 μm to less than 0.5 μm by air jet milling. Nitrogen probe can measure surface of primary particles even in the aggregates and hence there is only small increase in surface area when particle size is significantly reduced by de-aggregation.

16.3.4 Surface energy of particles

Surface energy of particles is another important parameter in powder technology. It determines the interactions between the particles as well as interaction with other material surfaces. Surface energy determines the adhesion properties of the particles. It also determines the particle cohesion. Surface energy also impacts wettability and high surface energy can reduce wettability of materials. Surface energy of materials with a flat surface can be measured using a contact angle test. Hence, contact angle is not appropriate only for measuring surface energy of powders. Reverse gas chromatography principle has been used to measure surface energy of natural fibre powders such as silk and wool (Rajkhowa et al., 2015b).

The reverse gas chromatography uses a range of non-polar gaseous probes (n-alkanes such as hexane, heptane, octane) to determine dispersive surface interactions such as van der Waals interactions. Polar gaseous probes (e.g. acetonitrile, acetone, ethanol, ethyl acetate and dichloromethane) are used to determine weak chemical bonds like hydrogen bonds or polar acid/base interactions.

In natural fibres, dispersive surface energy coming from non-polar short range physical interaction is much higher than the specific surface energy. Dispersive surface energy of silk fibres and particles falls in the range of 36.9–40.9 mJ m^{-2} . Cellulosic natural fibres are not much different. Specific surface energy of fibres increases a bit after milling but the increase is not remarkable. Similarly, the difference in specific surface energy of wet milled spray dried powder before and after air jet milling is negligible despite significant changes in size during air jet milling. There is a marked difference in specific surface energy between particles prepared from hydrolyzed fibre compared to non-hydrolyzed fibre. Silk powder with a $d(0.5)$ of about 5 μm and a smooth surface texture, as shown in Fig. 16.8(a), has a lower specific surface energy compared to particles prepared without alkali hydrolysis with typical grained surface architecture (Fig. 16.8(b)). Apparently the powder with higher specific surface area is more cohesive and less flowable. So hydrolyzed fibres can be used if powder with low cohesive energy and better flow properties are required.

16.3.5 Bulk and tapped density

Bulk density is the mass of powder of a given volume and takes into account the entrapped air within and between the particles in a powder bed. To measure bulk density, the powder sample is poured into a measuring cylinder from a given height at a fixed rate, and the volume and weight of powder are then measured. The bulk density thus obtained is also called Poured density. Bulk density measured after tapping the powder bed a fixed number of times at a certain speed to allow the particles to settle and thereby compacting the powder is termed as tapped density. Carr index, which is also called Carr compressibility index, is calculated from bulk and tapped density measurements.

$$\text{Carr Index} = \frac{\text{Tapped density} - \text{Bulk density}}{\text{Tapped density}}$$

Carr Index is an indication of the compressibility of the powder. Bulk and tapped densities depend on particle size, shape, surface morphology and surface energy. The density measurements are important for storage such as filling in a container and flow of powders during applications.

The bulk density of wet milled and spray dried silk and wool powder is around 0.19 g/cm^3 and their Carr index is around 0.36. This indicates that powder can be compressed by about 36% during tapping. The similar sized wet milled and spray dried powder from hydrolyzed fibre has a much higher bulk density of around 0.35 g/cm^3 and a Carr index of 0.12. Thus powder prepared from hydrolyzed fibre has less air between the particles due to their morphology as shown in Fig. 16.8. The low compressibility of about 12% as indicated by the Carr index comes from the already compact form of the powder due to its good flow when poured into a container. The higher flow, a compact powder bed and higher bulk density of powder from hydrolyzed silk are due to its low surface energy and smooth surface. The powder with a cauliflower like granulated surface (without hydrolysis) has a lower bulk density, higher compressibility and poorer flow. The lower compressibility of this powder compared to powder from non-hydrolyzed powder is shown in Fig. 16.11.

Finer particles are expected to have a higher bulk density as there should be less air between the particles. Increased fineness also makes the powder more cohesive and less flowable. In contrast after air jet milling of spray dried powder, its bulk density drops. For example, bulk density dropped from around 0.19 g/cm^3 to around 0.14 g/cm^3 for silk and wool powders (Rajkhowa et al., 2012a, 2015b). This happens due to formation of large aggregates by ultrafine jet milled particles. Those aggregates behave like large particles and have a large volume of air between the particles. However such powder can be compressed significantly if pressed as it results in breakage of the aggregates and then behave like fine cohesive particles. This reflects that apart from particle fineness, processing methods and morphology of particles of natural fibres play a critical role in determining their bulk properties.

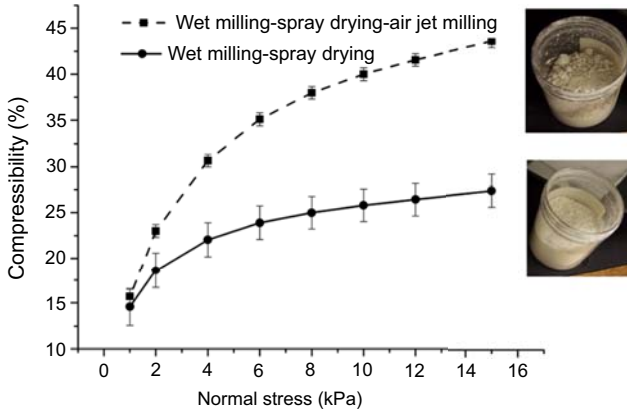

Figure 16.11 Compressibility of wool powder.

16.3.6 Cohesion and flowability of powder

A cohesive powder is also a less flowable powder. Powder flow is important for processing and use of powder at various stages such as delivering drug or other agents such as perfumery products in dry spray formulations, fluidization during particle coating, delivery of powder into a container or filling a tablet die from hopper. Since natural fibre powder has potential in many such applications, understanding and objective measurement of particle cohesion and flow properties are important.

Cohesion of particles is governed mostly by particle size, surface energy and surface morphology. For powder with a reduced specific surface energy such as the powder prepared from hydrolyzed fibres, the cohesion is relatively low. Finer particles with higher specific surface area are more cohesive and less flowable. Air jet milled particles despite their fineness do not behave like fine particles and have good flow because of large particles created by aggregates. Once consolidated by pressure, the aggregates collapse and fine particles are released from the aggregates, and they become highly cohesive and do not flow freely.

Powder rheometer such as FT4 measures the cohesion and flow properties of powders in loose and consolidated forms. Basic flow energy (BFE) measured by a powder rheometer is an objective measurement of powder flow behaviour. In this measurement, powder is compacted against the bottom of the cylinder containing the powder by the rotating blade during its downward movement. BFE is calculated from the energy needed by the rotating disc through the powder bed. Flowable powder creates a more compact bed and therefore greater amount of work is required for the movement of the disc resulting in a higher BFE. It has an inverse correlation with the Carr index. A flowable powder which has a low Carr Index has a high BFE. It is found that powder from hydrolyzed natural fibre as in Fig. 16.8(a), which has less surface energy and higher bulk density, is characterized with a higher BFE compared to powder from fibre without chemical hydrolysis.

Powder rheometer also measures the friction between the particles. In low shear, powder acts like solid and particles do not slide over each other. Above a specific shear stress, the particles start to slide over each other and fluidize, which is known as yield stress. The yield stress depends on the axial stress on the powder bed. It is possible to compute the yield stress at zero axial stress which is used to determine cohesion and flow function (ffc) of materials using a Mohr circle analysis according to ASTM standard D6773-02 and D6128-00. Flow function of one to two is considered very cohesive powder while two to four is considered a cohesive powder (Schulze, 2008).

Sub-micron air jet milled silk particles have cohesion of 3.5 kPa and very low flow function of 1.4. In case of wool, the flow function reduced from 3.7 to 1.6 after air jet milling indicating that the powder turned out to be highly cohesive. During measurement of shear properties the aggregates of ultrafine sub-micron particles in air jet milled powder are released and behave like a very cohesive powder. On the other hand, when wet milled spray dried powder is prepared from chemically hydrolyzed silk (Fig. 16.8(a)), the cohesion measured by rheometry is 1.4 kPa and flow function is 3.4, indicating that the hydrolysis prior to powder making produced less cohesive and more flowable particles. This is related to the lower surface energy and smoother surface morphology compared to cohesive powder with a cauliflower like surface morphology (prepared from fibre without chemical hydrolysis). It is possible to change the flow behaviour of powder by adding process control agents or by mechanofusion where a layer of other materials with a low surface energy is coated over particles by a mechanical action.

16.3.7 Biodegradation of fibre particles

Natural fibre powder has potential applications in biomedical products particularly as fillers in composites. Biodegradation of fillers is important for the working life as well as overall degradation behaviour of a product. Protein and cellulosic natural fibres are compostable and degraded by enzymes. The biodegradation rate of any material depends on different factors including chemical composition, morphology, microstructure and surface area. Surface area of particles is much higher than fibres. For example, the surface area of wool fibre snippets increased from 0.2 to 14.89 m²/g after 6 h attritor milling (Rajkhowa et al., 2012a). Since enzyme acts on the surface first, the mass loss happens through a surface erosion process. Thus, an increase in surface area leads to higher degradation rate (Horan et al., 2005). Enzymatic degradation of milled silk particles is known to cause a three-fold increase in mass loss compared to silk fibres (Rajkhowa et al., 2012b). The crystal structure is opened up considerably by the milling force, hence requiring a lower thermal energy for degradation compared to fibres. A reduced crystal peak found in X-ray diffraction of silk powders compared to silk fibres indicates less crystalline structure in milled powder (Rajkhowa et al., 2011a). The crystal defects also allow increased enzymatic degradation rate in natural fibre powders (Rajkhowa et al., 2012c).

16.4 Applications of natural fibre particles

The ability to turn fibres into particles with a large surface is the key feature to be utilized in new applications. Here are some examples where fibre powder has been explored in different applications.

16.4.1 Sorption applications

The high surface of ultrafine particles allows sorption of ions and molecules much faster than fibres. Sorption studies were performed using protein powders to understand kinetics of adsorption and release of transition metal ions and dye molecules. The sorption performance of natural fibre particles towards a particular type of metal ion varies with fibre type. For example, Zn^{2+} ion sorption follows the order: silk powder > wool powder > cashmere guard hair powder while an opposite trend was seen in the case of Cr^{6+} (Patil et al., 2012b).

The total amount of ions that can be loaded on powders at an equilibrium state is not higher than fibres. In some cases, the equilibrium absorption is even lower for particles. However, the kinetics of sorption is much faster for particles. Protein fibre particles adsorb cations at alkaline pH and release at acidic pH. Thus changing pH allows silk or wool to release and again adsorb transition metal ions such as Co^{2+} thereby allowing for separation of ions at a faster rate and for a number of cycles. The advantage of natural fibre powder is the active functional groups which, along with surface area of particles, provide rapid sorption kinetics compared to more inert materials such as activated charcoal in which the sorption is driven only by surface area. For example, dye sorption rate of wool powder is higher than activated charcoal although activated charcoal has a specific surface area of about $1000 \text{ m}^2/\text{g}$ compared to $15\text{--}20 \text{ m}^2/\text{g}$ of wool powder (Rajkhowa et al., 2012a; Wen et al., 2010). The advantage of powder form is clearly evident from relative dye absorption studies between wool fibres and wool powders. It takes about an hour for wool fibre to reach equilibrium state of dye sorption at around normal dyeing temperature of 90°C . It takes days for wool fibre to dye at room temperature. Wool powder, on the other hand, can pick up the same dye at room temperature within a few minutes (Wen et al., 2010). It is also reported that the loading capacity of transition ions on silk particles can be significantly higher than commercial ion-exchange resins (AG MP-50 and AG 50W-X2) indicating potential application in water purification and ion-exchange products (Rajkhowa et al., 2011b).

16.4.2 Biomedical applications

Natural fibre powder, particularly from silk, is useful for drug delivery, sustained release of enzymes, and reinforcing scaffolds for improving mechanical properties. Biomolecules are adsorbed on the surfaces and adsorption is governed mostly by electrostatic forces (Lammel et al., 2010). Surface chemistry of particles and charge in drug molecules are important both for binding and release properties. The surface charge in

particles (zeta potential), which changes with pH, is important and changing pH can change the drug loading and release behaviour. In neutral pH, most natural fibre particles have negative pH and therefore can bind to positively charged drug molecules.

If particles carrying the drug molecules are of sub-micron in scale then they can be internalized by cells. For example, eri silk particles of about 300 nm were used in delivering apo-bovine lactoferrin which is an anti-cancer drug to kill breast cancer cells (Roy et al., 2015). Silk fibre powders can also be used to improve self-life of peptide/enzyme. Ability of silk particles to bind insulin to improve the resistance to trypsin digestion has been reported, with the half-life improved by about 2.5 times (Yan et al., 2009). Milled silk particles were used also to bind industrial grade enzyme β -glucosidase (BGL). The enzymes bound to particles retain their activity for many cycles of use (Verma et al., 2013). Such enzymes are used in different fields and ability to use for more than once gives economical advantage. Good stability against dissolution in the physiological conditions allows milled natural fibre powders to be used and stored for repeated use for such applications.

Top down approach of particle production is suitable for all natural fibres. The particles can be used as fillers in implantable products and tissue engineering scaffolds because most natural fibres are known for their biocompatibility. Silk particles were used to reinforce scaffolds to improve mechanical properties of scaffolds tried in musculoskeletal tissue regeneration (Rockwood et al., 2011; Mandal et al., 2012; Fan et al., 2009). The median particle size used for reinforcement was $\sim 6 \mu\text{m}$ and wet compressive modulus of particle reinforced scaffolds increased from less than 100 KPa to about 2 MPa (Rajkhowa et al., 2010). It was found that silk particle fillers could improve differentiation of mesenchymal stem cells to bone-like tissues (Rockwood et al., 2011; Mandal et al., 2012). The bone-like tissue formation indicated by calcium deposition is demonstrated by micro-CT imaging of scaffolds as shown in Fig. 16.12. Silk particles can enhance bone formation and show potential applications in dental tissue engineering based on rabbit model (Jang et al., 2010). The ability to mill biocompatible fibres, such as silk, into fine particles can also be helpful for new applications in the cosmetic and pharmaceutical industries particularly as an efficient excipient (Rajkhowa et al., 2015b).

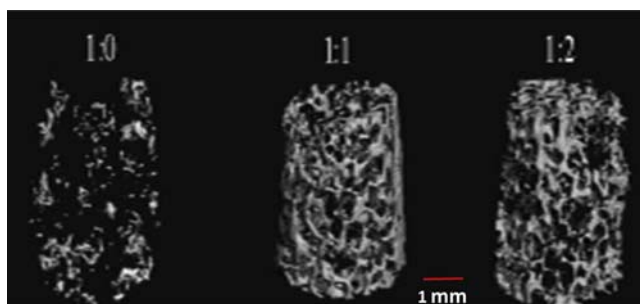

Figure 16.12 Micro-CT imaging of calcification of scaffold containing silk particle. Ratio Indicates weight ratio of matrix: particles (Rockwood et al., 2011).

16.4.3 Coating and printing

Milling of coloured natural fibre retains the colour of the fibre and hence produces a coloured powder. The colour can be either from a natural colour such as found in alpaca fibre or dyes used in colouration of textiles. Once ultrafine coloured particles are produced these can be used as pigments to coat or print a surface including textile coating and printing. For example, particles can be used for spray coating or screen printing. Image of a screen printed textile from coloured particles prepared from alpaca fibre is shown in Fig. 16.13. This gives an excellent opportunity to use colours from coloured textile wastes to create new designs. The particles can be used either in dry form such as produced by spray drying or in wet form from milled slurry directly if water based binder system is used to hold the particles on the surface.

16.4.4 3D printing

3D printing particularly 3D bio-printing of hydrogels has emerged as a new area in biomedical research. Two key challenges in bio-printing hydrogel are poor mechanical properties and low printing accuracy as the hydrogel is soft and shrinks during printing. Biocompatible natural fibre powders have been used in the bio-printing ink to improve both mechanical properties and shape fidelity of printed products. Milled silk powder of different shapes was recently used in 3D printing of chitosan scaffolds, which resulted in five-fold increase in compressive modulus of 3D printed products (Zhang et al., 2018). The process also significantly improved printing accuracy and scaffold stability. The shape of the particle fillers has a significant influence on printing accuracy and mechanical properties. Fine particles and particles with higher aspect ratio reduce shrinkage of printed products and also improve stiffness due to formation of networks by fillers.

Natural fibre powder can be used with thermoplastic polymers to alter properties. The change in hydrophilicity of polymer via the use of hydrophilic natural fibre powder as fillers can assist cell adhesion on polymers. Many natural fibres also have inherent cell binding elements such as RGD peptide in some silk species and hence the particles can improve cell adhesion of synthetic polymers.

The particles can also act as a nucleating agent to enhance the rate of crystallization and % crystallinity of polymers. This helps altering mechanical, degradation and other properties of synthetic polymers.



Figure 16.13 Coloured alpaca fibre and print using the powder from fibre.

The ability of adding fibre powder in polymers may be an effective route to reduce the cost of polymer products. The fillers can be added in moulded and extruded products of thermoplastic polymers. This is particularly relevant if particles can be prepared from fibre wastes from various stages of their life cycle.

Most natural fibres are thermally sensitive and degrade at high temperatures. Overcoming thermal oxidation is the key challenge in using fibre powder in thermoplastic processing. Often the temperature of processing is much below the degradation temperature of fibre powders indicated by differential scanning calorimetry (DSC) or Thermogravimetric analysis (TGA). However, there is significant risk of oxidative degradation during the high temperature processing as natural fibres turn yellow if kept for some time above 100°C or so. Usually it is safe to use natural fibre fillers with thermoplastic polymers with a relatively low melting point such as polycaprolactone (PCL). However, low melting point polymers also have a narrow application range. There are reports of using fibre powders with polypropylene (PP) and polylactic acid (PLA) using low residence time to avoid degradation of fibre powder. These polymers have melting temperature of about 170 and 180°C. If residence time is high then use of thermal protective agents is required.

16.5 Conclusion and outlook

Future trend of textiles is expected to be development of process technologies to reuse fibre and textile wastes for value added new applications beyond traditional textiles. In the case of natural fibres, they are currently limited to apparel uses mainly, despite their obvious advantage as renewable materials. Ability to convert any fibre both virgin and waste to ultrafine particles provides great opportunities for new and advanced applications. Natural fibre powder research is a relatively new area and has been restricted to only a few research groups. So far, research is limited mostly to protein fibres such as wool and silk but there is a huge opportunity to extend this to other natural fibrous materials. There are possibilities of applications in diverse fields such as textile and materials coating, surface modifications, fillers and reinforcements, cosmetics, biomedical, separation and environment technologies. A good understanding of production processes, characteristics, design of particles, economics of production are needed to take research towards commercialization and for that more research and development on the potential applications of natural fibre powders are still required. Future research in this area will be primarily on reducing energy and chemical uses to produce fine powders. Ability to process natural fibre powders using advanced technologies such as 3D printing will boost their application prospects. This will expand their uses in diverse fields. There is also scope for their use in environmental applications such as air and water purification products. Precise control of particle size and morphology and ability to functionalize particle surfaces and engineer their properties will have to be achieved to drive such developments.

References

- Camerucci, M.A., Cavalieri, A.L., 1998. Process parameters in attrition milling of cordierite powders. *J. Mater. Synth. Process.* 6, 115–121.
- Castro, C., De, L., Mitchell, B.S., 2002. Nanoparticles from Mechanical Attrition, Synthesis, Functionalization and Surface Treatment of Nanoparticles. American Scientific Publisher, pp. 1–15.
- Chen, K., Takano, R., Hirabayashi, K., 1992. Production of silk powder and method of decolorization. *Nippon Sanshigaku Zasshi* 61 (1).
- Cintas, J., Montes, J.M., Cuevas, F.G., Herrera, E.J., 2005. Influence of milling media on the microstructure and mechanical properties of mechanically milled and sintered aluminium. *J. Mater. Sci.* 40, 3911–3915.
- Fan, H., Liu, H., Toh, S.L., Goh, J.C.H., 2009. Anterior cruciate ligament regeneration using mesenchymal stem cells and silk scaffold in large animal model. *Biomaterials* 30, 4967–4977.
- Frances, C., Laguerie, C., 1998. Fine wet grinding of an alumina hydrate in a ball mill. *Powder Technol.* 99, 147–153.
- Gyung-Don, K., Ki-Hoon, L., Bong-Seob, S., Joong-Hee, N., 2002. Preparation and characterization of low molecular weight silk fibroin by high-temperature and high pressure method. *J. Appl. Polym. Sci.* 85, 2890–2895.
- Ha, S.J., Lim, G.B., 2001. Method for Manufacturing Silk Fibroin Powder, KR 2001060437.
- Hassabo, A.G., Salama, M., Mohamed, A.L., Popescu, C., 2015. Ultrafine wool and cotton powder and their characteristics. *J. Nat. Fibers* 12, 141–153.
- Hidefumi, T., Kazushige, I., Youichi, K., Fumio, Y., Tamikazu, K., 2000. Production of fine powder from silk by radiation. *Macromol. Mater. Eng.* 283, 126–131.
- Horan, R.L., Antle, K., Collette, A.L., Wang, Y., Huang, J., Moreau, J.E., Volloch, V., Kaplan, D.L., Altman, G.H., 2005. In vitro degradation of silk fibroin. *Biomaterials* 26, 3385–3393.
- Jang, E.-S., Park, J.-W., Kweon, H., Lee, K.-G., Kang, S.-W., Baek, D.-H., Choi, J.-Y., Kim, S.-G., 2010. Restoration of peri-implant defects in immediate implant installations by Choukroun platelet-rich fibrin and silk fibroin powder combination graft. *Oral Surg. Oral Med. Oral Pathol. Oral Radiol. Endodontol.* 109, 831–836.
- Kang, G.-D., Lee, K.-H., Shin, B.-S., Nahm, J.-H., 2002. Preparation and characterization of low molecular weight silk fibroin by high-temperature and high pressure method. *J. Appl. Polym. Sci.* 85, 2890–2895.
- Kazemimostaghim, M., Rajkhowa, R., Tsuzuki, T., Wang, X., 2013. Production of submicron silk particles by milling. *Powder Technol.* 241, 230–235.
- Kazemimostaghim, M., Rajkhowa, R., Tsuzuki, T., Wang, X., 2013. Ultrafine silk powder from biocompatible surfactant-assisted milling. *Powder Technol.* 249, 253–257.
- Kim, D.K., Kim, Y.H., Kim, K.B., Chin, Y.G., 2001. The changes of molecular weight and structure in the preparation process of silk fibroin powder. *J. Korean Fiber Soc.* 38 (3), 105–110.
- Kwade, A., 2005. Formation of nano-particles by wet grinding of stirred media mills. *Kagaku Kogaku* 69, 691–695.
- Lammel, A.S., Hu, X., Park, S.-H., Kaplan, D.L., Scheibel, T.R., 2010. Controlling silk fibroin particle features for drug delivery. *Biomaterials* 31, 4583–4591.
- Liang, S.B., Hu, D.P., Zhu, C., Yu, A.B., 2002. Production of fine polymer powder under cryogenic conditions. *Chem. Eng. Technol.* 25, 401–405.

- Liu, Y., Yu, Z., Shuxue, Z., Wu, L., 2006. De-agglomeration and dispersion of nano-TiO₂ in an agitator bead mill. *J. Dispersion Sci. Technol.* 27, 983–990.
- Lu, A., Arai, M., Kiyoshi, H., 1996. Production of tussah silk powder by hydrochloric acid hydrolysis. *Nippon Sanshi Gakkai* 65, 392–394.
- Mandal, B.B., Grinberg, A., Seok Gil, E., Panilaitis, B., Kaplan, D.L., 2012. High-strength silk protein scaffolds for bone repair. *Proc. Natl. Acad. Sci.* 109, 7699–7704.
- Oyama, S., 2006. Modified Powder for Liquid Composition for Molded Article, WO 2006016506.
- Palaniandy, S., Azizli, K.A.M., Hong, E.X., Hashim, S.F.S., Hussin, H., 2006. Custom made micronized silica for industry via fine grinding process. *AZojomo J. Mater.* 2. Online.
- Patil, K., Rajkhowa, R., Dai, X.J., Tsuzuki, T., Lin, T., Wang, X., 2012. Preparation and surface properties of cashmere guard hair powders. *Powder Technol.* 219, 179–185.
- Patil, K., Smith, S.V., Rajkhowa, R., Tsuzuki, T., Wang, X., Lin, T., 2012. Milled cashmere guard hair powders: absorption properties to heavy metal ions. *Powder Technol.* 218, 162–168.
- Rajkhowa, R., Wang, L., Wang, X., 2008. Ultra-fine silk powder preparation through rotary and ball milling. *Powder Technol.* 185, 87–95.
- Rajkhowa, R., Wang, L., Kanwar, J., Wang, X., 2009. Fabrication of ultrafine powder from eri silk through attritor and jet milling. *Powder Technol.* 191, 155–163.
- Rajkhowa, R., Gil, E.S., Kludge, J.A., Numata, K., Wang, L., Wang, X., Kaplan, D.L., 2010. Reinforcing silk scaffolds with silk particles. *Macromol. Biosci.* 10, 599–611.
- Rajkhowa, R., Wang, L., Kanwar, J., Wang, X., 2011. Molecular weight and secondary structure change in eri silk during alkali degumming and powdering. *J. Appl. Polym. Sci.* 119, 1339–1347.
- Rajkhowa, R., Naik, R., Wang, L., Smith, S.V., Wang, X., 2011. An investigation into transition metal ion binding properties of silk fibers and particles using radioisotopes. *J. Appl. Polym. Sci.* 119, 3630–3639.
- Rajkhowa, R., Zhou, Q., Tsuzuki, T., Morton, D.A.V., Wang, X., 2012. Ultrafine wool powders and their bulk properties. *Powder Technol.* 224, 183–188.
- Rajkhowa, R., Hu, X., Tsuzuki, T., Kaplan, D.L., Wang, X.-G., 2012. Structure and biodegradation mechanism of milled *B.mori* silk particles. *Biomacromolecules* 13, 2503–2512.
- Rajkhowa, R., Hu, X., Tsuzuki, T., Kaplan, D.L., Wang, X., 2012. Structure and biodegradation mechanism of milled *Bombyx mori* silk particles. *Biomacromolecules* 13, 2503–2512.
- Rajkhowa, R., Kaur, J., Wang, X., Batchelor, W., 2015. Intrinsic tensile properties of cocoon silk fibres can be estimated by removing flaws through repeated tensile tests. *J. R. Soc. Interface* 12, 20150177.
- Rajkhowa, R., Kafi, A., Zhou, Q.T., Kondor, A., Morton, D.A.V., Wang, X., 2015. Relationship between processing, surface energy and bulk properties of ultrafine silk particles. *Powder Technol.* 270, 112–120.
- Rockwood, D.N., Gil, E.S., Park, S.-H., Kluge, J.A., Grayson, W., Bhumiratana, S., Rajkhowa, R., Wang, X., Kim, S.J., Vunjak-Novakovic, G., Kaplan, D.L., 2011. Ingrowth of human mesenchymal stem cells into porous silk particle reinforced silk composite scaffolds: an in vitro study. *Acta Biomater.* 7, 144–151.
- Roderiguez, J.A., Gallardo, J.M., Herrera, E.J., 1997. Structure and properties of attrition-milled aluminium powder. *J. Mater. Sci.* 32, 3535–3539.
- Roy, K., Patel, Y., Kanwar, R., Rajkhowa, R., Wang, X., Kanwar, J., 2015. Biodegradable Eri silk nanoparticles as a delivery vehicle for bovine lactoferrin against MDA-MB-231 and MCF-7 breast cancer cells. *Int. J. Nanomed.* 11, 25–44.

- Sano, M., Mikami, S., Sasaki, N., Kusamoto, N., Fukatsu, F., Ubara, A., Yasue, T., Ohyama, S., 1998. Substance Including Natural Organic Substance Fine Powder, US 5718954.
- Schulze, D., 2008. Powders and Bulk Solids; Behavior, Characterization. Storage and Flow.
- Shida, K., Hidefumi, T., 2001. Kamiishi, Change in Silk Protein by Radiation, Takasaki Symposium on Radiation Processing of Natural Polymers, pp. 85–93.
- Stenger, F., Mende, S., Schwedes, J., Peukert, W., 2005. Nanomilling in stirred media mills. *Chem. Eng. Sci.* 60, 4557–4565.
- Suryanarayana, C., 2001. Mechanical alloying and milling. *Prog. Mater. Sci.* 46, 1–184.
- Verma, M., Rajkhowa, R., Wang, X., Burrow, C., Puri, M., 2013. Exploring novel ultrafine Eri silk bioscaffold for enzyme stabilization in cellobiose hydrolysis. *Bioresour. Technol.* 145, 302–306.
- Watson, M.J., Chan, H.M., Hammer, M.P., Caram, H.S., 1998. Effect of milling liquid on the reaction-bonded aluminium oxide process. *J. Am. Ceram. Soc.* 81, 2053–2060.
- Wen, G., Cookson, P.G., Liu, X., Wang, X.G., 2010. The effect of pH and temperature on the dye sorption of wool powders. *J. Appl. Polym. Sci.* 116, 2216–2226.
- Xu, W., Cui, W., Li, W., Guo, W., 2004. Development and characterizations of super-fine wool powder. *Powder Technol.* 140, 136–140.
- Xu, W., Wang, X., Cui, W., Peng, X., Li, W., Liu, X., 2009. Characterization of superfine down powder. *J. Appl. Polym. Sci.* 111, 2204–2209.
- Yan, H.-B., Zhang, Y.-Q., Ma, Y.-L., Zhou, L.-X., 2009. Biosynthesis of insulin-silk fibroin nanoparticles conjugates and in vitro evaluation of a drug delivery system. *J. Nanoparticle Res.* 11, 1937–1946.
- Yasuda, K., 1996. Tests on the new utilization technique of silk protein. 1. Establishment of simple manufacturing technique for pulverization of silk protein and tests on the use of silk protein as a food material. *Gifu-ken Sanshi Kenkyusho Yoho* 6, 46–56.
- Zhang, J., Allardyce, B.J., Rajkhowa, R., Zhao, Y., Dilley, R.J., Redmond, S.L., Wang, X., Liu, X., 2018. 3D printing of silk particle-reinforced chitosan hydrogel structures and their properties. *ACS Biomater. Sci. Eng.* 4, 3036–3046.

The application of flax and hempseed in food, nutraceutical and personal care products

17

*Anna Bakowska-Barczak*¹, *Marie-Anne de Larminat*², *Paul P. Kolodziejczyk*²

¹Formulation & Product Development Lead, Process & Product Development, Radiant

Technologies Inc., Edmonton, AB, Canada; ²Biolink Consultancy, New Denver, BC, Canada

17.1 Introduction

For centuries industrial hemp and flax have been a source of both fibre and oilseed worldwide to produce a variety of industrial and consumer products including food and beverages, nutritional supplements, cosmetics and personal care products, fabric and textiles, yarns and spun fibres, paper, construction and insulation materials, and biofuel.

Flax, one of the first crops grown by humans, was widely used in Egypt and China 8000–5000 years ago and already common in Europe around 5000 BC. Hemp cultivation for fibre and later for seed began in China about 2800 BC (Dewey, 1914; Pengilly, 2003; Dunford, 2015). Both flax and hemp probably reached the Americas with the Spanish in the 16th century (Dewey, 1914). Shortly after that, flax and hemp became one of the major crops in the West thanks to official policies; in 1535 H VIII passed an act compelling all English landowners to sow 1/4 of an acre with hemp or be fined, while Charlemagne strongly encouraged the cultivation of flax in France. These policies were continued in colonial America where free land and hempseed were offered to immigrants who moved to Canada; farmers were required by law to grow hemp in Virginia and other colonies. It is estimated that, through the 1920s, 80% of clothing was made from hemp fibre (the original ‘Levi’s’ jeans were made from hemp cloth).

With the development of steam machines, cotton ginning and other industrial innovations, the importance of both flax and hemp as textile fibres gradually faded. Today, flax and hemp have far more potential as oilseed crops than as fibre sources. The global market for flax and hempseeds is expected to grow in the next few years. According to Persistence Market Research report, the North America flax seed market is anticipated to grow from 250.5 million USD in 2015 to 308.4 million USD by 2021 (Persistence Market Report, 2018). Similarly, the hempseed-based food market is expected to grow to 2.6 billion USD in 2025 (WiseGuys Report, 2018). Increasing health awareness, growing population, more demand on environmentally friendly products and vegan ingredients are predicted to drive the growth of flax and hempseeds over the forecast

period. Very recently, hemp gained additional attention due to cannabidiol (CBD), a non-psychoactive cannabinoid present in its flowers and leaves that has been recognized as a medicinal product.

17.2 The economic factors affecting flax and hemp industrial production

17.2.1 Flax

Although flax has been cultivated since ancient times, it is not a major oilseed crop today accounting for about three million tonnes of flaxseed in 2016 (Table 17.1).

Today's edible oil seed market is dominated by palm oil, soy, sunflower and rape/canola. However, the observations that the ratio of omega-6 to omega-3 unsaturated fatty acids had become too high and unhealthy because of changes in dietary habits (Simopoulos, 1999), prompted the research and development of different types of oilseeds, rich in omega-3 polyunsaturated fatty acids and apt for human consumption. This explains why flax, with a 70% of total fatty acid content as omega-3 alpha-linolenic acid, has gained a new notoriety.

The geographic distribution of flaxseed production has changed dramatically over the last 50 years, as a result of political and economic processes. Today Canada is still a major producer of flaxseed with China, which is becoming an important seed supplier.

17.2.2 Hemp

Hemp (*Cannabis sativa*) is known throughout the world and has been cultivated for thousands of years, first for fibre, and later for oil and food. Currently, hemp is cultivated for commercial or research purposes in at least 47 countries in Europe, Asia and North and South America.

Like flax, hemp is grown for either seed or fibre. In Europe, hemp is grown mainly for fibre production. Only small areas were used exclusively for hempseed production, in contrast to Canada where almost all hemp is grown mostly for seeds. But this has changed in the last few years, as more and more producers in Europe started to cultivate hemp for seed and flower production only. In Canada, from 2010 to 2016 the production of seeds increased from around 70,000 to 94,000 tonnes (35% growth) driven by the increasing demand from the food market (Fig. 17.1).

Table 17.1 Global production of flax and hemp seed.

Year	1961	2016
Flaxseed	3,014,416	2,925,282
Hempseed	79,746	93,949

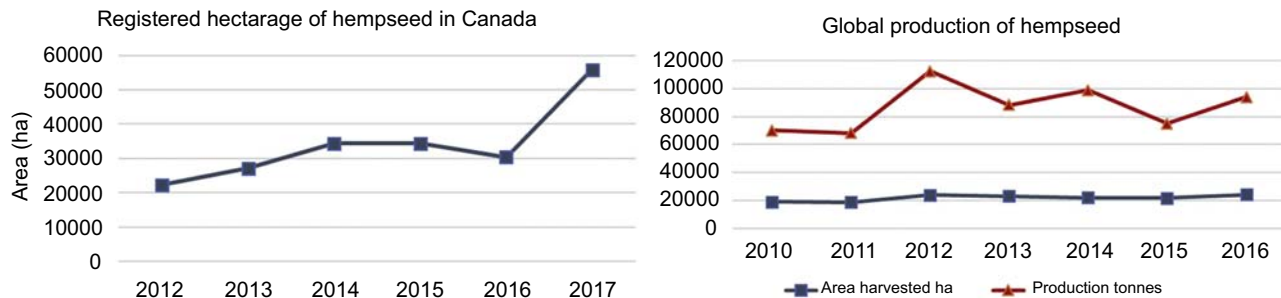

Figure 17.1 Global production of hempseed (tonnes) and hectareage in 2010–16.

Source: FAOSTAT 05/10/2018 based on data from 10 countries; [Alberta Agriculture and Forestry \(2017\)](#).

Increasing demand for hempseed prompted a significant increase in its cultivation area, especially in Canada, where the registered land use of hempseed doubled in 2017 (Fig. 17.1). Viewed as an eco-friendly and highly sustainable crop, the global market for hemp is predicted to double from year 2016–2020 (Schlutenhofe and Yuan, 2017). Canada, China, Chile, France, and North Korea are currently the largest producers of hemp. The United States is the largest importer of hemp products, obtaining most of its seed from Canada (Johnson, 2017).

While direct market information on revenue is not available, the Government of Alberta, based on discussions with some hemp producers in Alberta, reported that the sales price of hempseeds in 2011 was approximately CDN \$0.90–1.00; with a yielding of 300 kg/ha on 15,828 licenced hectares. Based on the yield estimates, Canadian hempseed production is approximately 15,513 tonnes — assuming all hectares were harvested — translating to an estimated gross revenue of CDN \$30–34 million (Laate, 2012).

New opportunities for hemp are opening currently around the world with the increased interest in cannabidiol (CBD) related products and changes in hemp regulations. In a recently released report by Vote Hemp and Hemp Business Journal, the retail value of hemp related products reached \$820 million in 2017, a 30% increase in 2 years (Vote Hemp, 2017). The hemp-derived CBD products constituted 23% (\$190 million) of total sales and had a 66% increase in sales value in 2 years (Hemp Industries Association, 2016). This market is predicted to reach 1 billion dollars in the United States by 2020 (Webmed.com a, 2018).

With the predicted advance of hemp industry, other related products such as health food and feed, improved construction materials or biofuel, should penetrate this multi-billion dollars market, helping to solidify a long-term sustainable growth (Schlutenhofe and Yuan, 2017).

17.3 Properties and chemical composition of flax and hempseed

The importance of oilseed in human and animal diet is related to the two main components oil and protein. Flax, hemp, sunflower and canola contain high amounts of oil (in the 40% range), while soybeans are grown mostly for the protein (oil content only 20%). Oil and protein contents of common oil seed are presented in Table 17.2.

17.3.1 Oil composition in flax and hempseeds

The oil composition of both flax and hempseeds is particularly relevant from a nutritional and functional food viewpoint. Both are unusually rich in polyunsaturated fatty acids (PUFAs), essential dietary components with important actions in the cell membrane phospholipid bilayer and in other essential bodily functions and regulatory mechanisms.

Table 17.2 Oil and protein content in common oil seed.

Source	Oil content [%]	Protein content [%]
Flaxseed	40–46	20
Hempseed	30–35	22–25
Sunflower seed	40–45	20–24
Soybean	20	40
Rapeseed/Canola	45–48	23–25

Source: Authors data.

Fig. 17.2 shows the profile of different edible oils, including linola, a modified flax variety with low alpha-linolenic acid (ALA) content, designed to increase its stability and suitability as edible oil.

While omega-3 ALA stands out in the flax oil composition (53%), with omega-6 oleic acid and linoleic acid found in lower amounts (19% and 16% respectively), hemp has a larger proportion of omega-6 linoleic acid (54%), with respect to the other omega-3 fatty acids it contains, namely alpha-linolenic acid (ALA), gamma-linolenic acid (GLA) and stearidonic acid (SDA) (Kolodziejczyk et al., 2012). So, while flax oil has a higher total omega-3 fatty acids content (53%) than hemp (26%), hempseed oil composition is more diversified regarding the omega-3 fatty acids.

In fact, hempseed oil has the ideal ratio of 3:1 omega-6 to omega-3, which makes it an excellent oil dietary source of plant origin, recommended by nutritionists. Western diets are deficient in omega-3 fatty acids, and have excessive amounts of omega-6 fatty acids (ω -6: ω -3 ratio of 16 or higher) what promotes the pathogenesis of many

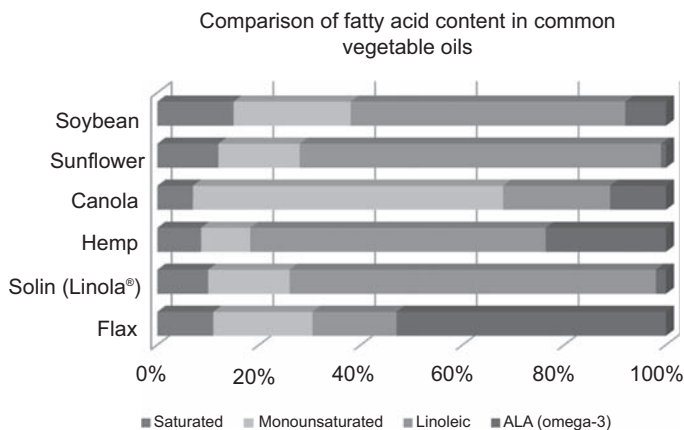
**Figure 17.2** Essential fatty present in common vegetable oils.

Source: Kolodziejczyk, P.P., Ozimek, L., Kozłowska, J., 2012. The application of flax and hemp seeds in food, animal feed, health and cosmetics. In: Kozłowski, R. (Ed.) Handbook of Natural Textile Fibres: vol. 2: Types, Properties and Factors Affecting Breeding and Cultivation. Woodhead Publishing Limited, Cambridge, UK, pp. 329–366.

diseases, including cardiovascular disease, cancer, and inflammatory and autoimmune diseases (Simopoulos, 2002). Flax in turn is an excellent supplier of essential oil omega-3 ALA.

The main fatty acids in flax and hempseeds are shown in Table 17.3. Hempseed contains up to 2% of stearidonic acid (SDA). SDA is an important metabolic intermediate between ALA and eicosapentaenoic acid (EPA) in the EFAs biosynthetic pathway. SDA is found in fish oil at levels of up to 4% as well as in plants such as evening primrose, echium and black currant.

17.3.2 Protein profile of flax and hempseeds

Both flax and hemp exhibit protein contents that are comparable to other main oilseeds with the exception of soybean (Table 17.2).

The major storage proteins in flax seeds are linin (11–12 S) and conlinin (2 S) that have molecular masses of 252–298 kDa and 16–17 kDa, respectively (Chung et al., 2005; Dev and Quensel, 2006; Oomah and Mazza, 1993). Hemp protein contains albumin and edestin in a 1:2 ratio. Albumin and edestin are proteins containing essential amino acids, including sulphur-containing methionine, which is deficient in most other vegetable protein (Callaway, 2004). Both hemp and flax have high arginine level proteins (Table 17.4) that are particularly desirable to health-conscious people who can use it as a dietary tool to maintain cardiovascular health (Aluko, 2017). In the

Table 17.3 Major fatty acids profile in flaxseed and hemp seed oil.

Fatty acid	Abbreviation	Code	Type	Hemp [%]	Flax [%]
Total saturated fatty acids	SFAs	16:0, 18:0	—	8	11
Oleic acid	OA	18:1n12	<i>omega</i> -6	9	19
Linoleic acid	LA	18:2n6	<i>omega</i> -6	54	16
<i>alpha</i> -linolenic acid	ALA	18:3n3	<i>omega</i> -3	22	53
<i>gamma</i> -linolenic acid	GLA	18:3n6	<i>omega</i> -6	4	traces
Stearidonic acid	SDA	18:4n3	<i>omega</i> -3	2	traces
Polyunsaturated fatty acids omega-6: Omega-3 ratio	PUFA	-	-	82 3.0	69 0.24

Table 17.4 Amino acid composition of flax and hemp seed protein (as a % of total protein).

Amino acid	Hemp	Flax
Tryptophan	1.63	0.81
Threonine	4.19	4.02
Isoleucine	4.90	3.42
Leucine	6.76	6.52
Lysine	4.72	4.19
Methionine	2.03	2.61
Cystine	1.86	1.44
Phenylalanine	5.24	4.40
Tyrosine	2.70	2.89
Arginine	10.53	11.42
Valine	5.87	4.12
Histidine	2.58	3.17
Alanine	5.06	5.18
Aspartic acid	11.20	11.91
Glutamic acid	22.10	19.56
Glycine	6.83	4.26
Proline	4.41	4.79
Serine	5.31	5.28

Source: Selected from the USDA, 2018. Nutrition Data Base [following section, bioactive properties related to protein hydrolysates of hemp and flax protein will be discussed.](https://ndb.nal.usda.gov/ndb/foods/show/12012?n1=%7BQv%3D1%7D&fgcd=&man=&lfacet=&count=&max=25&sort=default&qlookup=hemp+seeds&offset=&format=Full&new=&measureby=&Qv=1&ds=SR&qt=&qp=&qa=&qn=&q=&ing= database 2018 a,b.</p>
</div>
<div data-bbox=)

In conclusion, the oil and protein in flax and hempseed are important both quantitatively and qualitatively. Other nutrients complete a profile of highly nutritive seeds that may be use in traditional or novel food products.

17.4 Nutritional and health effects of flax and hemp

Both flax and hempseeds are an excellent source of nutrition. Their comparative nutrient profile is displayed in [Table 17.5](#). Principally, they are very rich in essential fatty acids (EFAs), contain almost as much protein as soybean and are also rich in vitamin E and minerals such as phosphorus, potassium, sodium, magnesium, sulphur,

Table 17.5 The comparative nutrient profile of hemp and flax.

Nutrient	Hemp seed	Flax seed
Energy	553 kcal, 2200 kJ	534 kcal
Protein	23–25 g	19–32 g
Total lipid (fat)	35.5 g	38–45 g
Ash	6 g	4 g
Carbohydrates	28–34 g	13–33 g
Fiber, total dietary	27.6 g	28 g
Lignans	0	10–2600 mg
Moisture	6.5 g	6 g
Calcium, Ca	70 mg	255 mg
Iron, Fe	7.95 mg	5.73 mg
Magnesium, Mg	700 mg	342 mg
Phosphorus, P	1650 mg	642 mg
Potassium, K	1200 mg	813 mg
Sodium, Na	5 mg	30 mg
Zinc, Zn	9.9 mg	4.34 mg
Vitamin C	1.0 mg	0.6 mg
Thiamin	1.275 mg	1.644 mg
Riboflavin	0.285 mg	0.161 mg
Niacin	9.2 mg	3.08 mg
Vitamin B-6	0.6 mg	0.473 mg
Vitamin A	11 IU	0
Vitamin E	85.8 mg (α -tocopherol 0.8 mg; γ -tocopherol 85 mg)	23.3 mg (α - tocopherol 0.3 mg; γ -tocopherol 23 mg)

Source: USDA, 2018. Nutrition Data Base <https://ndb.nal.usda.gov/ndb/foods/show/12012?n1=%7BQv%3D1%7D&fgcd=&man=&lfacet=&count=&max=25&sort=default&qlookup=hemp+seeds&offset=&format=Full&new=&measureby=&Qv=1&ds=SR&qt=&qp=&qa=&qn=&q=&ing= database a.b.>

calcium, iron, and zinc (Callaway, 2004; Teh and Birch, 2013). Hemp and flax seeds are free of gluten, therefore could be used as dietary components for people with celiac disease.

17.4.1 Oils

17.4.1.1 Flax seed oils

Flax seed oil is of great value to nutrition because of the high PUFA content, specifically alpha-linolenic acid. For the same reason, the oil is not suitable for cooking due to its tendency to auto-oxidation, which results in polymerization and development of off-flavours during storage and cooking. Modifications of the oil composition with the aim of obtaining an edible, stable flax oil, with a much lower ALA content, were attempted and led to suitable modified flax varieties such as Linola and Solin (Dribnenki and Green, 1995; Hosseinian et al., 2004).

Major components of flax oil are triglycerides; however, the oil contains also several minor lipophilic molecules including sterols and tocopherols as indicated in Table 17.5.

Flax oil for human consumption, bottled or encapsulated, is 'cold-pressed' at temperatures below 35°C. The residue after pressing flax seed is called 'cake' and might be further processed using solvent extraction or supercritical CO₂ extraction, to produce lipid-free 'meal'. The 'meal' makes a valuable source of protein for animal feed (Kolodziejczyk and Fedec, 1995), but contains other bioactive substances: lignans, cyclopeptides and cyanogenic glucosides. An excellent review of those substances is discussed in the monography Flax: Genus linum (Westcott and Muir, 2003).

17.4.1.2 Hempseed oils

Hempseed oil's unusually well-balanced mixture of omega-6 linoleic and omega-3 linolenic acid has important dietary benefits: it produces a lower total-to-HDL cholesterol ratio (this ratio is a predictor of coronary heart disease) (Schwab et al., 2006). Results of recent in vivo studies show a close relationship between the fatty acid content of hempseed oil and indicators of cardiovascular health (Al-Khalifa et al., 2007; Richard et al., 2007; Prociuk et al., 2008). The discrete amount of gamma-linolenic acid in hempseed oil strengthens further its health benefits. Indeed, gamma-linolenic acid exerts anti-inflammatory activity and can be converted to di-homo-gamma-linolenic acid and further to prostaglandin series-1, another group of eicosanoids with potential anti-inflammatory and immunoregulatory effects (Veselinovic et al., 2017).

17.4.2 Protein

Flax and hemp proteins have been the subject of increasing interest from academia and industry regarding bioactivity. Recently, several enzymatically hydrolyzed seed

storage proteins have been investigated for the presence of bioactive peptides possessing immuno-stimulating and anti-hypertensive activities.

17.4.2.1 *Flax seed protein*

Flax seed proteins have shown potential to regulate blood pressure and to lower cholesterol level. Those and other biological activities seem to depend on the proteins' degree of hydrolysis (Marambe et al., 2008). Flaxseed meal contains peptide amino acid sequences that may be exploited as potential food sources for lowering blood pressure based on their angiotensin converting enzyme (ACE)-inhibitory activity. ACE inhibitors work by inhibiting the conversion of angiotensin I to the potent vasoconstrictor, angiotensin II, thereby improving blood flow and blood pressure. Those findings prove that flax protein and its hydrolysates can be valuable components for functional food and feed markets (Udenigwe et al., 2009). Several papers and patents describe the extraction process and fractionation of protein from flax meal (Chung et al., 2005; Dev et al., 1986; Kankaanpaa-Anttila and Anttila, 1999; Oomah and Mazza, 1993; US Patent 6998466, 2006).

17.4.2.2 *Hempseed protein*

Hempseed contains about 25%–30% protein and is currently gaining a big interest as a source of plant-based protein isolates. Hempseed contains mainly the storage proteins, albumin (25%–37%) and the legumin called edestin (67%–75%) and does not contain protease inhibitors. The absence of protease inhibitors is believed to contribute to enhanced protein digestibility properties. The essential amino-acid content of hempseed proteins is superior to that of soybean and is sufficient for humans who are 10 years of age or older. It was demonstrated (House et al., 2010), that *in vitro* protein digestibility values were up to 92% for dehulled hempseed. Albumin and edestin contained in hempseeds are both proteins rich in methionine and arginine. High arginine content makes hempseed protein especially valuable as a nutritional ingredient to formulate foods that enhance cardiovascular health. This is because arginine is a precursor of nitric oxide, the vasodilating agent that enhances blood flow and contributes to maintenance of normal blood pressure (Wu and Meininger, 2002).

17.4.3 *Tocopherols and polyphenols*

Beyond protein and lipid, and like flax, hempseeds contain tocopherols (mainly gamma-tocopherol, Table 17.5) compounds, with anti-oxidant activity. Other anti-oxidants identified in hemp and other oilseeds include polyphenols (Axelson et al., 1982), Frassinettia et al. (2018); Multari et al. (2016); Teh and Birch (2013) and lignanamides (Yan et al., 2015). Besides anti-oxidant activity, lignanamides showed significant anti-neuroinflammatory activities in *in vivo* studies (Zhou et al., 2018) suggesting their contribution in overall hempseed health benefits.

17.4.4 Cannabinoids

Hemp plants contain unique and beneficial phytochemicals. The most interesting among these constituents are those found in the secretions of the head cells of glandular hairs (trichomes) distributed across the surface of the *Cannabis* plant, which include cannabinoids and terpenes. Cannabinoids are naturally occurring polyphenols that are unique to the *Cannabis* plant (Russo et al., 2008). Over 70 cannabinoids have been identified in *Cannabis* (Hazekamp et al., 2010) with THCA (tetrahydrocannabinolic acid) and CBDA (cannabinoldiolic acid) being the most abundant (Fig. 17.3).

In fresh plant material all cannabinoids are present in their acidic form (CBDA or THCA for example). The acidic cannabinoids can be converted into their decarboxylated (neutral) analogues (CBD, THC) under the influence of light, heat, or prolonged storage, by losing the relatively unstable carboxylic group in the form of carbon dioxide (Hazekamp et al., 2010). Delta-9-tetrahydrocannabinol, commonly known as THC, is the most potent narcotic factor in cannabis. Industrial hemp contains only traces of THC, mainly as a residue after the plant flowering stage, as narcotic substances are present mostly in buds and flowers. The main cannabinoid in hemp is the non-psychoactive cannabidiol (CBD) and its concentration in industrial hemp depends on the genotype, plant development stage and cultivation, among other factors (Rustichelli et al., 1988).

Cannabidiol (CBD) was recently recognized as a medicinal product. It has been demonstrated as an effective treatment of epilepsy in several clinical trials, with one pure CBD product (Epidiolex) with completed Phase III trials and under current review for approval in the United States. There is also evidence that CBD may be a useful treatment for several other medical conditions related to its neuroprotective,

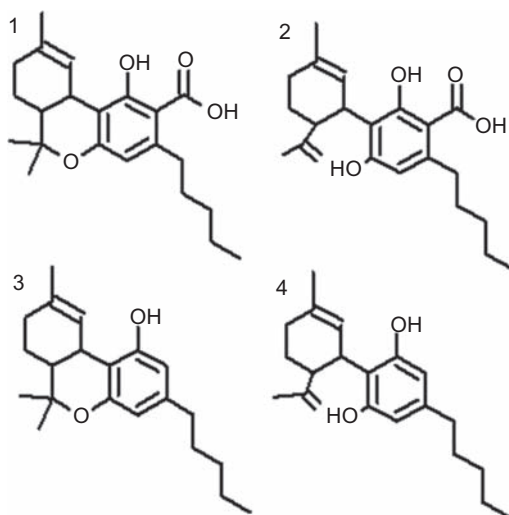

Figure 17.3 Structures of main cannabinoids present in *Cannabis sativa*.

hypoxia-ischaemia, ansiolytic, anti-psychotic, analgesic, anti-inflammatory, anti-asthmatic, immunomodulatory, anti-psychotic and anti-tumour properties (Fasinu et al., 2016; Iffland and Grotenhermen, 2017; Devinsky, 2014). The evidence for some of these indications was recently reviewed by Burstein (2015) and Pisanti et al. (2017) and reported by the World Health Organization (WHO Report, 2017). CBD is a very promising cannabinoid as it has also shown potential as therapeutic agents in preclinical models of central nervous system diseases such as neurodegenerative diseases, schizophrenia, multiple sclerosis, affective disorders and the central modulation of feeding behaviour (Hill et al., 2012). Interestingly, CBD presents also strong anti-fungal and anti-bacterial properties, and furthermore, a powerful activity against methicillin-resistant *Staphylococcus aureus* (MRSA) (Appendino et al., 2008).

The effects of cannabidiol on various skin ailments such as acne and dermatitis are backed by several research studies and makes it interesting for topical uses.

CBD and other cannabinoids such as delta-9-tetrahydrocannabinol (THC) are non-psychoactive substances with multiple sebostatic and anti-inflammatory properties, which are exerted through their interaction with receptors at intracellular level (Oláh et al., 2016).

The possible anti-acne, anti-psoriasis and anti-inflammatory properties of cannabinoids are supported by various other studies, as well as their regulation of itch and pain at the skin and follicle level (Singh et al., 2018). An important body of research concerning the pathogenesis and treatment of acne was provided by an international research team (Oláh et al., 2014). They examined the effects of CBD on human sebaceous glands in skin organ culture and found that hemp CBD normalizes excessive lipid synthesis, decreases cell proliferation but not viability, and exerts universal anti-inflammatory action. It is also interesting to note that endocannabinoids and synthetic cannabinoids have shown to inhibit melanoma and non-melanoma skin cancer growth both in vitro and in vivo (Soliman et al., 2016).

17.4.5 Terpenes

More than 120 terpenes have been identified in hemp, most of them monoterpenes (Hazekamp et al., 2010). These volatiles are giving the hemp its distinct fragrance. The sesquiterpene α -caryophyllene-epoxide, for example, is the main compound that search dogs are trained to recognize (Hazekamp et al., 2010). Only one unusual terpene can be found in *Cannabis*: the monoterpene *m*-mentha-1,8(9)-dien-5-ol. α -Pinene, myrcene, trans- α -ocimene, α -terpinolene, trans-caryophyllene and α -humulene are the main terpenes found in essential oil of industrial hemp (Novak et al., 2001).

Terpenes in hemp are reported to have anti-inflammatory, anti-bacterial and anti-viral properties (Vonapartis et al., 2015; Andre et al., 2016). The flowers, roots, and leaves of hemp contain mono- and sesquiterpenes (up to 98% of all terpenes), with monoterpenes contributing to the volatile terpene profile (Andre et al., 2016). The medicinal properties of terpenes were reviewed by Russo (2011) and more recently by Nuutinen (2018). Myrcene, the most abundant terpene in hemp, protects the brain, heart and skin tissues from inflammation and oxidative damage (Nuutinen, 2018).

According to recent studies, α -pinene exhibits anti-metastatic and anti-tumour activities along with anti-inflammatory and anti-oxidant effects (Nuutinen, 2018). Another terpene, β -pinene, shows antidepressant activities (Guzmán Gutiérrez et al., 2012, 2015). Among terpenes, only beta-caryophyllene shows high affinity to cannabinoid receptors and the cytochemical bioassay (CBA) agonism holds great potential to treat a variety of neuroinflammatory diseases.

It is claimed that terpenes and cannabinoids evoke a so-called ‘entourage effect’, which means that the terpenes could have synergistic actions with cannabinoids (Russo, 2011). Currently there is not enough data supporting or explaining this complex interplay.

17.5 Flax and hemp related products for food and dietary supplements for human and animal nutrition

17.5.1 Hemp-based products for human nutrition

Flax and hempseeds have been consumed as food in the past, and the by-products of oil extraction were used as feed for domestic animals. Continuing the traditions, whole, ground or roasted flax seeds have been added to baked goods and hemp has been prepared in hot cereal dishes. During the last 3 decades, however, we have witnessed the birth and exponential growth of the nutraceutical and functional food market, which have changed considerably the status of flax and especially hempseeds. Flaxseed, flax oil or flaxseed meal containing flax lignan precursors are found on the shelves of health food stores and general supermarkets all over the world. Flaxseed has been incorporated into bakery products, breakfast cereals as an important additive, enriching normal food in polyunsaturated fatty acid or so-called ‘soluble fibre’. The latest term is used for the mucilage present in flaxseed. Flaxseed has been fed to hens with the aim to produce the ‘Omega-3’ eggs, i.e. eggs containing elevated level of ALA (Sim and Qi, 1995; Kozłowska et al., 2009). Some bioactive components of flax seed, namely mucilage and lignans, have gained a position in the nutraceutical and functional food markets (Hall et al., 2006).

Interest in commercial hemp foods started around the 1990’s with the rapid growth of hempseed food products in the last few years. In 2013, out of the 11,500 tons of European production of hempseeds – 13% was used for hemp oil production, 43% for food and 44% as animal feed (Carus, 2017). Hempseeds are recognized as superfood with their highly nutritious content of proteins, vitamins, minerals, fibre and fatty acids. They can be eaten raw, integrated into bread, cakes, biscuits, breakfast cereals, pasta, cakes, dairy products, juices or superfood snacks.

From January 2008 to November 2017, there were 452 launches of products containing hemp around the world (Agriculture and Agri-Food Canada, 2018). From those, 293 belonged to the food category, 141 to the drinks category, and 18 were in the pet food category (Table 17.6).

Table 17.6 Hemp-containing products launched by region and category, from 2008 to 2017.

Region	Food	Drinks	Pet food	Total products by region
Europe	215	41	17	273
North America	61	86	1	148
Latin America	11	2	0	13
Middle East and Africa	4	8	0	12
Asia Pacific	4	2	0	6
Total	293	141	18	452

Source: Agricultural and Agri Food Canada, 2018.

Most hemp-containing products were launched in Europe (60%) and North America (33%) in countries such as United States, Germany, United Kingdom and Canada, respectively (Fig. 17.4).

Over half of the hemp-containing products launched from 2008 to 2017 used hemp protein as ingredient, incorporated into snack bars, meal replacements and beverages. Other hemp ingredients used were hempseed oil and hemp flour (Agriculture and Agri-Food Canada, 2018).

A fast and simple process of obtaining hemp protein isolate (86% protein), easy to digest and free of any allergens was presented recently supporting the use of hemp proteins as an ingredient for hypoallergenic foods (Mamone et al., 2018). Also recently, the effect of addition of hemp protein or hemp meal to starch-based gluten-free bread was described (Korus et al., 2017). The gluten-free bread with hemp had significantly improved nutritional value and sensory acceptability.

There are currently numerous Canadian companies working to fulfil the demand for hempseed products – including Hemp Oil Canada Inc., Hempola Valley Farms, Manitoba Harvest, Ruths Hemp Foods, Cool Hemp, Natures Path, HempCo etc. As one of

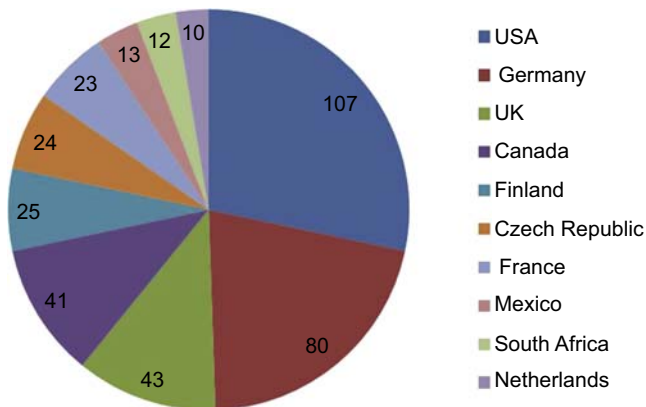
**Figure 17.4** Top 10 countries to launch hemp-containing products from 2008 to 2017.

Source: Agricultural and Agri-Food Canada.

the global leaders in hemp-based foods, Manitoba Harvest works together with over 125 Canadian farms to supply products to approximately 7000 retail stores across the United States and Canada (Manitoba Harvest Hemp Foods, 2017). In addition, this company saw a 500% growth in sales from 2010 to 2015 (Bickis, 2015). Experts predict hemp oil production will continue to thrive, especially in health food and pharmaceutical products categories (Alberta Agriculture and Forestry, 2017; Cherney and Small, 2016).

Hemp is currently gaining a lot of attention related to cannabidiol (CBD). CBD can be easily extracted from the flowers and leaves of industrial hemp as a high value by-product. In 2013, 240 tonnes of flowers and leaves for medical applications, food supplements (CBD) and the production of essential oil (for food and beverages) were produced compared to only 7.5 tonnes in 2010 (Carus, 2017). The most popular retail format of CBD supplement currently available on the market is oil in drop dispensing bottles.

There are numerous CBD products including claimed medicinal products, such as pills and capsules for various diseases/symptoms, and also lotions, oils, foods, drinks, shampoos, cosmetics, etc. that are being manufactured and distributed without regulatory oversight and often with unverified contents (Bonn-Miller et al., 2017; Hazekamp, 2018). Despite the growing availability of CBD, many uncertainties remain about the quality and safety of these new products. The U.S. Food and Drug Administration has issued several major series of warning letters to manufacturers for fraudulent medical claims (describing health benefits with no evidence) and fraudulent production claims (marketing products as containing specified concentrations of CBD when testing demonstrates the absence of CBD) (US FDA, Website). More research is needed to understand the impact of impurities and/or contaminants on the safety of these products.

17.5.2 Hemp-based products for animal nutrition

In countries where hemp is grown, the seeds are traditionally used for cattle and poultry as a concentrated energy feed. The oil cake has been used for fattening cattle (Hassle et al., 2008). It is an excellent natural source of rumen-undegradable protein that is equivalent to heat-treated rapeseed meal. When substituted for rapeseed meal, hempseed oil meal included at 20% of diet had no detrimental effects on feed intake or nutrient utilization by sheep (Mustafa et al., 1999). Hempseeds have a high energy content and are a traditional staple of mixes for pet birds and poultry. Addition of up to 20% dried and crushed hempseeds to a broiler diets resulted in higher breast, leg and thigh weight. This positive effect has been linked to the combination of a good protein and lipid quality associated to other beneficial properties, such as the lack of trypsin inhibitors and the anti-oxidant activity of cannabidiol (Khan et al., 2009). Hemp-based feed contributes also to the quality of animal-based food. Supplementation of laying hen diets with 25% hempseeds decreased egg yolk total cholesterol, and the content in monounsaturated fatty acids, while total and individual polyunsaturated fatty acids as well as omega-3 and omega-6 fatty acids increased significantly (Halle and Schöne, 2013; Shahid et al., 2015). Moreover, inclusion of hemp oil in broiler

chicken diets resulted in the enrichment of omega-3 PUFAs and GLA in thighs and breast meat (Jing et al., 2017).

The hemp feed industry is skyrocketing in the last 2 years due to overwhelming interest in CBD supplements for pets and horses. There is preliminary evidence that CBD supplements reduce pain, improve digestion and appetite, calm anxiety, and reduce inflammation and arthritis (Wallace, 2017).

17.6 Regulatory issues regarding novel flax and hemp products

The growing interest in cannabinoids, mainly THC and CBD, has been accompanied by a parallel interest in the cultivation of the hemp variety of cannabis. Typically grown for its fibre or seeds, hemp is generally low in cannabinoid content. In Europe and Canada, specific hemp varieties may be cultivated, and they must have no more than 0.2% for Europe (EU Regulation 1307/2013), 0.3% for Canada (Health Canada, 2017) or up to 1% THC in Switzerland (Swiss Government website, 2011), as measured in the dried flowering portion of the plant.

Internationally, there is a continuous move of cannabis regulatory approaches from criminalization to decriminalization and legalization. Currently, the possession of non-medical cannabis is legal in Uruguay, and as of 17 October 2018 in Canada.

The legalization of cannabis in Canada began in 1998, after 60-year long ban, when production of industrial hemp was legalized stimulating an increase production of hemp. In April 2017, the Canadian government introduced Bill C-45, the Cannabis Act, aimed at legalizing and regulating the production and sale of cannabis. Under the new regulations industrial hemp licences are permitted to possess, transport, research and sell industrial hemp leaves, flowers and branches (or the whole plant). New regulations also modify physical security requirements for industrial hemp licences treating industrial hemp storage as any other agricultural product without special security restrictions. The Canadian Government has indicated that it intends to add cannabis edible products and cannabis concentrates to the list of products permitted for legal sale once appropriate regulatory controls are developed.

Hemp was widely grown in the United States through the mid-1800s. The US government considered industrial hemp like any other farm commodity until the year 1937, when hemp was defined as a narcotic drug and its cultivation was banned. Finally, in 1970 hemp was classified as a Schedule I controlled substance. However, during World War II the Japanese attack on Pearl Harbour shut off supplies of fibre from the Philippines. The USDA produced a film called 'Hemp For Victory' to encourage U.S. farmers to grow hemp for the war effort. The U.S. government formed the War Hemp Industries Department and subsidized hemp cultivation. The program was so vital to the war effort that farmers and their sons who signed up for the program were deferred from military service for the duration of the war. During the war, U.S. farmers grew about a million acres of hemp across the Midwest as part of that program.

Currently, recreational cannabis is also legal for adults in nine US states and the District of Columbia, and 31 states have government-sanctioned, medical cannabis programs. The possession limit is regulated in selected states, see: Marijuana State Laws – Summary Chart from [ProCon.org](https://procon.org) ([ProCon](https://procon.org), 2018).

In April 2018 the Hemp Farming Act of 2018 was a proposed law to remove hemp (defined as cannabis with less than 0.3% THC) from [Schedule I controlled substances](#). The act, if passed, would permanently remove hemp from regulation as a controlled substance and treat it as an agricultural commodity. This will allow CBD hemp preparations to be legally sold in all 50 states.

The recent depenalization of *Cannabis sativa/indica* for recreational use in Canada (17 Oct 2018) has expanded the possibilities for commercialization not only of the herb and buds, but of other products containing variable amounts of THC with together with CBD. The legal maximum concentration of THC where depenalization did not occur is 0.3%. Consequently, it is possible to formulate products with larger amounts of other cannabinoids such as CBD, which is said to exhibit similar healing properties and keep the THC level legal. A good example of this trend is provided by examining the Peace Natural Project website ([Peacenaturals](#), 2018).

In the European Union, it is legal to cultivate and supply cannabis plants for hemp fibre if they have low THC levels. The granting of payments under the Common Agricultural Policy is conditional upon the use of certified seeds of specified hemp varieties; only varieties with a THC content not exceeding 0.2% may be used ([EU Regulation 1307/2013](#)). Payments are therefore granted only for areas sown with varieties of hemp offering certain guarantees with regard to their psychotropic content. Currently, CBD oil is legal in most EU members as medicine with exception of Slovakia where it is illegal ([Daiba](#), 2018). Similarly, in Australia and New Zealand CBD preparations are legal for therapeutic use when their containing 2% or less of other cannabinoids found in *Cannabis* ([Australian Government Department of Health Therapeutic Goods Administration](#); [New Zealand Government Ministry of Health](#), 2015).

17.7 Application of flax and hemp in cosmetics and personal care

The skin is not only the largest organ of our body, but it is also its most visible part. Its function is to protect and insulate the body against external agents and to activate the first line of the immune defence system. Any structural or physiological alteration of the skin may have consequences for our whole health, and conversely, our skin state may reveal a disorder located elsewhere in the body. Realizing the importance of the skin since early stages, humans have used their ethnobotanical knowledge to care for it, keeping it moist and nourished. They also tried to improve their appearance with the use of cosmetics.

The use of flax and hemp in cosmetics and personal care products has both ancient and modern components. Both plants are known since millennia and both have been

used not only as fibre and oil sources, but also in preparations to condition or heal the skin, the scalp and even the epithelial lining of airways and intestines. In modern times, while the textile and industrial oil application of flax and hemp has gradually been relegated to the background, food and cosmetic grade oils, as well as other newly discovered components of these plants have been placed on the main stage. Essential fatty acids are abundant in both oilseeds, but other compounds such as flax lignans and mucilage gums, together with hemp cannabinoids and polyphenols are all relevant biomolecules being now extensively investigated, supporting an increasingly important industry.

This section will review the traditional and modern uses of flax and hemp in the area of cosmetic and skin care, with a focus on topical uses but without ignoring the well reported effects of dietary flax and hempseeds or oil on skin health maintenance and for the treatment of specific ailments such as inflammation and itch, acne, psoriasis or skin cancer.

17.7.1 Traditional uses of flax and hemp for the skin

The external uses of flaxseed oil are as ancient as the discovery of this versatile crop (Pengilly, 2003; Dunford, 2015).

Egyptians in particular, used flaxseed oil as a face and body ointment, in social, religious and sport events and for protection against the sun, wind and insects. It was important for the embalming of corpses and a common base for perfumes and balms, hair styling lotions and cosmetic dyes (Vaisey-Genser and Morris, 2003; Pengilly, 2003).

This tradition continued in the Middle East and later in the Greco-Roman world, the Europe of Middle Ages and beyond. Rulers of the time encouraged the cultivation and use of flax, as it proved to be a plant with multiple benefits, for home and industry and for human health.

Linseed oil was used to clean and refresh the body, as water was often scarce or unclean, and as a base for the preparation of unguents, emollient balms and liniments to treat inflammation, abscesses and burns; (the word liniment evolved from Latin *linum* and is related to the act of ointing or smear, Vaisey-Genser and Morris, 2003). Freshly obtained linseed oil was rubbed on sore joints to relieve arthritis, soothe the pain of burns and help with the healing process (Pengilly, 2003; Kaur et al., 2018). Poultices with linseed meal had multiple uses, for internal and external ailments including those of the digestive system. ‘The emollient action of a poultice, made by grinding the flax seeds, boiling them in water and placing the resulting mash on clean cloth to retain the heat and protect the skin, ...easing the pain’. Even now, poultices of linseed meal are used to relieve the discomfort caused by psoriasis, shingles and other skin disorders. Not only the oil has proven useful to soothe skin and relieve sores: Flax mucilage is effective as a demulcent, refreshing and protecting irritated and inflamed internal tissue, in the airways or intestine. Linseed infusions and teas directly applied externally to dry skin or added to the bath have an emollient action (Pengilly, 2003; Goyal et al., 2014; Kaur et al., 2018).

All of the abovementioned traditional uses of flax for skin health and care are still current to some extent. Simple and wholesome, although not always substantiated by science, their validity stems from centuries of tradition.

There is some parallelism between the history of flax and hemp crops, although some characteristics of hemp single it out among other fibre and oil yielding plants: Industrial hemp has the same scientific name as the marijuana plant, *Cannabis sativa* L., a variety that contains the psychotropic substance THC, banned in most countries.

Muñoz (2018) cites the topical use of *Cannabis sativa* L. (hemp) in ancient China, to treat skin rashes, ulcers, wounds and hair loss; and in ancient Egypt, to treat eye conditions and wounds. In Europe hempseed oil was used to make soap, among other industrial applications.

17.7.2 Modern applications of flax and hemp in personal care and cosmetic products

17.7.2.1 Flax

Important discoveries since the 50s regarding the biochemical composition of flax and many other botanicals have revolutionized the field and added to a renewed popularity of herbal remedies and natural products. Polyunsaturated fatty acids (PUFAs), particularly abundant in flax oil, were recognized as essential nutrients.

Towards the 80–90s, a population that was strongly involved with their personal health and favourable to environmentally friendly products welcomed this ‘return to the sources’, now based on scientific data, about bioactive constituents that may elicit medicinal or preventative health care use. The newly acquired knowledge ‘substantiated the claim that the secret to wellness lied in nutraceuticals and phytochemicals that are found in wholesome natural products’ (Pengilly, 2003).

The terms ‘functional food’ and ‘nutraceuticals’ were introduced to refer to defined components in edible or beneficial plants that have ‘physiological benefits and/or reduce the risk of chronic disease beyond basic nutritional functions’ (Vaisey-Genser and Morris, 2003) Nutraceutical refers specifically to an isolated or purified product, as opposed to the food itself, consumed as part of a usual diet. Several components of flax qualify as functional food or nutraceutical (Gojal et al, 2014).

17.7.3 Flaxseed oil

When it became apparent that many of the benefits found in flaxseed oil were possibly due to its main component α -linolenic acid (ALA), many products containing flaxseed oil were developed, claiming benefits for the skin, hair, feet and even teeth (Activation Products, 2018).

To avoid the development of unwanted effects associated with the rapid oxidation of ALA in the presence of air, seeds are now cold-pressed and packaged under conditions that minimize exposure to air and light. Addition of anti-oxidants such as tocopherols and rosemary extract in formulations is routine.

A large fraction of the cosmetic use of flaxseed oil concerns skin conditioning and emollient action. Direct topic application in daily, small dosages of pure, cold-pressed oil is particularly prevalent. It has been suggested that the oil helps control secretion of the skin own sebaceous glands, acts as a protective barrier against moisture loss and even facilitates the access of active ingredients in creams such as retinol to the lower layers of the skin. (Sonya Dakar Com, 2018 <http://sonyadakar/blog/facial-oil-5-reasons-your-skin-needs-it>).

Flaxseed oil may also be an ingredient in lotions, serum or creams, the omega-3 fatty acid being claimed as the active ingredient for rejuvenation, smooth and healthy looking skin, as well as a relief of irritation or itch (Beautyglimpse blog, 2018).

17.7.3.1 Flax soap

Flaxseed oil is a valuable ingredient in cold-processed soaps, with good tracing and hardening times, smooth texture and strong lathering properties. The saponification value (SAP) for flax oil is in the range of 187–196, depending on the batches. The oil is mixed with the usual proportion of palm and coconut solid fats (3-4:2-1), castor oil and vitamin E or rosemary extract are added to minimize oxidation, especially if the soap is super-fatted. The soap is very stable with time and provides a good skin feel and conditioning; it is harder than hemp or avocado based soaps, and resembles castile (olive) soap, only with more lather production (M.A.L, personal observations).

17.7.3.2 Flaxseed oil in haircare products

Flaxseed oil is also often found in haircare products, such as shampoos, conditioners and styling or defrizzing lotions, where it is reported to provide softness and lustre, and to minimize itching and dandruff (Activation Products, 2018). In this regard, flax oil is used alone or as ingredient, including in pet products, as the oil is supposed to provide a ‘glowing’ effect on hair or fur.

17.7.4 Other flax components relevant for skin care

17.7.4.1 Phenolic compounds and tocopherols

A recent study provided good evidence that the phenolics extracted from flax shives (fibre by-product) have a positive role in the healing process when using cultured fibroblasts (Czemplik et al., 2017). These data tend to corroborate the healing action of flaxseed in traditional folk recipes.

Tocopherols are present in most oilseeds including flax (Oomah and Mazza, 1997) and may be valuable endogenous anti-oxidants in creams and lotions containing flaxseed oil. Flax contains 85 mg of α -tocopherol, and lesser amounts of γ -tocopherol.

17.7.4.2 Flax mucilage gums

The composition of the flaxseed mucilage gum coating the seed hull has also been examined recently, and possible uses of this viscous component as an emulsifier,

foaming gel or natural stabilizer in mixtures have been suggested (Liu et al., 2018). Styling, shaving, hand creams and moisturizers are prepared using linseed mucilage as ingredient (Lush Hand Made Cosmetics, 2018). Flax mucilage was traditionally obtained by decantation of seed soaked in water for a few hours and used internally and externally (Goyal et al., 2014).

17.7.5 Flax products safety

Lastly, it is worth noting that the possible toxicity of flaxseed products, which has indeed always been a concern (Muir and Westcott, 2003; Kaur et al., 2018), is restricted almost entirely to its long-term internal (dietary) use, with the exception of rare acute allergic reactions in some individuals exposed to flax dust or flax proteins. Topical applications are generally safe, the only problem being the possible spoilage and inactivation of the oil associated with storage time and/or exposure to heat, light and air.

In conclusion, the use of flax, an ancient and versatile textile and oilseed plant, has acquired a new life in the last decades, in part because of societal interest in plant-based, natural products and also because of the numerous advances in the knowledge of its biochemical composition and the possible role of its bioactive components. In particular, the essential ω -3 fatty acid ALA appears to be involved in the preservation of hair or skin good appearance and health and hence is useful as a functional food and in cosmetic and personal care products. Taken internally, lignans and other phenolics may have a role in specific skin-related ailments. Mucilage gum extracted from flax seed coat shows good qualities as a protecting and texture modifying ingredient in lotions and gels.

17.7.5.1 Hemp

Hempseed oil

In the last decades, hemp oil received considerable interest thanks to its rich content in polyunsaturated fatty acids (PUFAs), of which the main component is the ω -6 linoleic acid (60%), the ω -3 α -linolenic acid, ALA (25%) and ω -6 oleic acid (15%), with lower amounts of ω -3 stearidonic (SDA) and γ -linolenic fatty acids (Callaway and Pate, 2009; Callaway et al., 1996). The crops cultivated in northern (colder) climates contain more PUFAs than elsewhere (Ross et al., 1996). Hemp oil contains also appreciable levels of anti-oxidant tocopherols and phytosterols in the non-saponifiable fraction (Montserrat et al., 2014; Pojic et al., 2014). When properly extracted and protected from air, the oil possesses a pleasant nutty aroma.

Hemp soap and a wide array of products for personal care containing hemp oil are being developed and advertised on the internet, in part because of their alleged conditioning and soothing qualities but also possibly because of the curiosity and appeal conferred by the semi-illegal status of *Cannabis sativa*, or marijuana, a close cousin of industrial hemp, which attracts a niche clientele. It is common to see labels such as 'BC Bud' or 'Doapsoap', or products stamped with the emblematic marijuana leaf, even when a reassuring message such as 'it won't make you high!' appears

sometimes (Hippiebutter, 2017), probably aimed at more mainstream clients. Industrial hemp used in these products does not contain psychotropic compounds, or just trace amounts.

The advertisers also try hard to make their hemp-containing products fit with the environmentally conscious, vegetarian and animal friendly profile of their possible clients, whereby labelling their products as ‘vegan’, ‘organic’, ‘chemical free’, ‘not tested in animals’ or ‘pure and natural’. Some products containing hemp oil and advertised in major online stores are designed to treat pets’ ‘damaged skin’ or calm down their anxiety.

How are the claims of manufacturers, reviewers and bloggers about hemp oil products, substantiated by research?

The main effects of topical or dietary intake of hemp oil relate to the improvement of skin appearance through moisturizing, nourishing and rejuvenating, and the relief of irritation and other cutaneous disorders such as oily skin, acne or psoriasis (Healthline, 2018; Anmariegianni blog, 2018; Beautymunsta, 2018).

These actions are likely mediated by the essential fatty acids contained in hempseed oil, but other components, collectively called cannabinoids may also have a role in the soothing and protecting actions on skin. The phytosterols and tocopherols may provide additional protection against oxidation and damaging free radicals (Montserrat et al., 2014).

While the medically oriented Webmd website (2018) warns that hemp effects on skin are ‘inconclusive’, some research does give some support to the claim that the oil moisturizes and soothes the skin, and normalizes excessive oil secretions.

In a recent meta-research paper published by specialists in dermatology (Singh et al., 2018) it is reported that the oral administration of two tbsp of cold-pressed hempseed oil for 8 weeks was compared with cold-pressed olive oil administration in regard to skin dryness and itch caused by atopic dermatitis. Statistically significant improvements were obtained with the hemp-treated patients, although the intra-epidermal water loss was not statistically significant. No negative side effects or metabolic changes were associated with the treatment.

Surely, the extrapolation of systemic administration to topical application of a given product must be considered with great caution. However, hemp-derived products applied topically may have beneficial actions on the skin, particularly to control sebum production and relieve irritation and even to address more serious dermatological conditions: a 3% *Cannabis* seed extract in a cream topically administered to men for 12 weeks decreased sebum and erythema, while being otherwise well tolerated (Ali and Akhtar, 2015).

Hempseed oil in soaps and shampoos

Soap containing hempseed oil as an ingredient seems to be appreciated by soap makers and their clients, even when the oil is considered a little tricky to work with. The SAP value is 191 but the reaction is slow. In small batch manufacturing (i.e. cold-process) and moderate proportions, it produces a smooth textured, emollient, and moisturizing soap, which compensates for its relatively slow saponification time and its tendency to

rancidity if unprotected with anti-oxidants like vitamin E or rosemary extract. The unsaturated, fluid hemp oil requires at least 48 h to fully harden and needs to be protected from air and heat before and during processing. (MAL, personal observations, and Miller Cavitch, 1997).

Although many ‘hemp’ soaps and shampoos offered for sale on low cost e-commerce internet websites appear amateurish and hastily formulated to attract consumers, with hemp often being just a minor component, there are also manufacturers with reliable formulations producing quality soaps, shampoos and shower gels, with beneficial action to the skin, scalp and hair, which are advertised in mainstream e-commerce sites or their own websites.

Certainly, the specificity of hempseed oil’s therapeutic effects could be questioned, as most oils have moisturizing and soothing qualities anyway, so the doubt expressed by Muñoz (2018), on whether hemp oil ‘goes further than any other preparation containing polyunsaturated fatty acids and favouring skin hydration’ appears valid.

Other hemp compounds acting on the skin

Three types of compounds of hemp are relevant for skin health: the essential fatty acids (EFAs), the cannabinoids, and the phytosterols.

Although the protein and amino-acid profile of hempseed is very relevant from a nutritional and skin health point of view, its effects are obtained only through long-term dietary intake. This, admittedly, might also be the case for several actions reported about essential fatty acids and cannabinoids, which would then be acting on the skin ‘from inside out’.

The two most commonly discussed chemical compounds found in *Cannabis* reported to have therapeutic benefits are δ -9-tetrahydrocannabinol (THC), and (–)-cannabidiol (CBD). They are found in both industrial hemp and marijuana plants, and CBD is present in the oil obtained by extracting the whole plant, including buds and flowers. It is referred as CBD oil and should not be confused with hempseed oil.

Recent research findings reviewed by Hanus et al. (2016) and Muñoz (2018) indicate an important role for cannabinoids in the treatment of several skin ailments. Data suggest that these compounds act through specific receptors found in skin cells and are involved in key regulatory mechanisms at this level. For example, atopic dermatitis (AD) is a frequent chronic inflammatory disease of the skin. Its clinical characteristics include dryness of the skin, erythema, exudation, scabs and ‘lichenification’. The intense itching accompanying these symptoms leads to scratching and possible infection by *Staphylococcus aureus*. Cannabinoids, acting through CB1 and CB2 receptors, modulate the inflammatory response, relieve the itch and prevent infection (Wollemberg, 2014; Appendino et al., 2008).

A similar action has also been shown for the treatment of psoriasis (Derakhshan and Kazemi, 2016), and in experimental models of dermal fibrosis (Marquardt et al., 2010; Balistreri, 2011; Del Río, 2016)

To conclude, hemp oil, known and used during centuries for different purposes, occupies today an important place in the market of natural products for personal care, thanks to its valuable essential fatty acid composition and its association with

the *Cannabis sativa* name. Used alone or as part of a formulation, hempseed oil provides moisturizing, soothing and anti-ageing protection to skin and hair. It is available in solid and liquid soaps, shampoos and hair conditioners, beauty creams or serums, and sun protection lotions.

Recent research indicates the role of cannabinoids in a receptor-mediated modulation of skin functions and inflammatory responses, which suggests that CBD could be an effective topical ingredient for the treatment of acne, atopic dermatitis, psoriasis and fibrotic disease.

17.7.6 Flax and hemp in the cosmeceutical industry

Over the ages, together with human progress, cosmetics have evolved continuously, from the use of whole plants and crude extracts or mixtures to sophisticated formulations with both natural and synthetic ingredients. Nowadays, the cosmetic market is global and highly competitive, and terms such as quality, efficacy and safety are essential. Consumers can have extremely sophisticated demands and expect constant novelty. Thus, scientific researchers and product developers must continuously create new, distinctive products.

Scientific research has made a huge step forwards in this field and the producers of cosmetic ingredients are now aware that science, in particular cell and molecular biology techniques, not only can help in understanding what the real efficacy of cosmetic products is but represents a key tool to confirm whether biologically active ingredients intended for production are safe for consumers. Industry has also new term describing those novel products: ‘cosmeceutical’, to describe a new form of cosmetic which combines cosmetic and pharmaceutical properties meeting consumers’ demands for their high efficacy (Martin and Glaser, 2011).

These changes are creating new rules for the market. Using uncharacterized plant extracts in skin care creams, most of the time containing unknown compounds, is no longer accepted. Currently used plant extracts require a high definition and availability in standard concentrations with scientifically proven effects. Their activity on the skin must be scientifically demonstrated through in vitro and clinical studies. Some companies choose to develop a propitiatory delivery method which allows them to protect their own segment of the cosmeceutical market. An example is a transdermal delivery patch allowing for infusion of selected cannabinoids in a controlled manner (US Patent Appl. 2015/0297556).

Hopefully, those products which have only anecdotal support, or those that try to attract customers using flashy names or packaging material, often called « snake-oil », will eventually disappear. Cosmeceuticals will represent novel products adhering to standards of manufacturing practices, quality and regulatory rules (Peschel, 2016).

Obviously, there will be a cost to customers. According to Muñoz (2018), “One important reason why few pharmaceutical companies are developing drugs for skin diseases is that the economic return on such drugs (especially topical skin products)

is relatively small when compared to the market for pharmaceuticals for other conditions (i.e. cancer or cardiovascular diseases). The same author cites also the impossibility of establishing intellectual property for ingredients such as *Cannabis sativa* in products for inflammatory diseases of the skin, a fact that discourages investment in the development of cosmeceuticals at a large scale, and results in consumers using non-pharmaceutical products, of often unproven efficacy (Rinaldi, 2008).

However, the new *Cannabis* legislation introduced in Canada and United States has caused a tremendous rush on the investor market. Cosmetic, pharmaceutical and biotechnology companies are investing serious capital in the *Cannabis* related business. As stated earlier, it is expected that only scientifically proven benefits of the plant will be considered in the development of new products.

Cosmeceuticals are the manifestation of a convergence of medical science, biotechnology and beauty, and have revolutionized the world of skin care. By understanding the basic scientific mechanism of how cosmeceuticals work on the skin, one can design more specific products, addressing a wide range of functions that the end user can rely on. The ancient plants *Linum usitatissimum* and *Cannabis sativa* have a new role in this trend.

17.8 Conclusion

Flax and hemp are unusually diverse crops that can contribute to the seed/oil, fibre, and medicinal product markets. The global market for products derived from flax and hemp is anticipated to grow in near future due to higher demand for healthy products. Several components of flax seed are of interest to the nutraceutical market. Flax seed oil, lignans and mucilage have a strong position in this market. New flax cultivars with modified fatty acids content are currently under development. Those cultivars will serve as an alternative to existing vegetable oils and/or provide new dietary oils containing high levels of DHA, EPA and other EFAs. Hempseed oil with its optimal ratio of omega-3/omega-6 fatty acids, very rare in plant kingdom, and highly digestible proteins placed hempseed in a superfood category. Both hemp and flax seed have a long history as a good quality protein feed for cattle and poultry. Research data also proved that a diet rich in hemp and flax seeds or seed cake can positively modify the fatty acid composition of eggs, milk or meat indirectly improving the quality of food.

Undoubtedly, the regulatory changes currently happening in the cannabis market around the world will intensify research and clinical studies related to hemp and the CBD. The potential opening for hemp is tremendous and with projected substantial revenue have a real chance to revolutionize the food, feed, cosmetic and pharmaceutical industries.

References

- Agriculture, Agri-Food Canada, 2018. Ingredient Focus – Hemp in packaged food and beverages accessed. <http://www.agr.gc.ca/eng/industry-markets-and-trade/international-agri-food-market-intelligence/ingredient-focus-hemp-in-packaged-food-and-beverages/?id=1521040623287>. (Accessed 31 October 2018).
- Alberta Agriculture, Forestry, 2017. Industrial Hemp Enterprise. March 2017. [https://www1.agric.gov.ab.ca/\\$department/deptdocs.nsf/all/agdex126](https://www1.agric.gov.ab.ca/$department/deptdocs.nsf/all/agdex126).
- Benefits of Flax, 2018. <https://www.activationproducts.com/blog/benefits-of-flax>.
- Al-Khalifa, A., Maddaford, T.G., Chahine, M.N., Austria, J.A., Edel, A.L., Richard, M.N., Ander, B.P., Gavel, N., Kopilas, M., Ganguly, R., Ganguly, P.K., Pierce, G.N., 2007. Effect of dietary hemp seed intake on cardiac ischemia-reperfusion injury. *Am. J. Physiol. Regul. Integr. Comp. Physiol.* 292, 98–203.
- Ali, A., Akhtar, N., 2015. The safety and efficacy of 3% Cannabis seeds extract cream for reduction of human cheek skin sebum and erythema content. *Pak. J. Pharm. Sci.* 28, 1389–1395.
- Aluko, E., 2017. Hemp seed (*Cannabis sativa L.*) proteins: composition, structure, enzymatic modification, and functional or bioactive properties. In: Nadathur, S.R., Wanasundara, J.P.D., Scanlin, L. (Eds.), *Sustainable Protein Sources*. Elsevier, Boston (USA), pp. 121–132.
- Andre, C.M., Hausman, J.F., Guerriero, G., 2016. *Cannabis sativa*: the plant of the thousand and one molecules. *Front. Plant Sci.* 7, 19. <https://doi.org/10.3389/fpls.2016.00019>.
- Annamariegianni, 2018. Six Benefits From Hempseed Oil. www.annmariegianni.com.
- Appendino, G., Gibbons, S., Giana, A., Pagani, A., Grassi, G., Stavri, M., Smith, E., Rahman, M.M., 2008. Antibacterial cannabinoids from *Cannabis sativa*: a structure-activity study. *J. Nat. Prod.* 71, 1427–1430.
- Annual Retail Sales for Hemp Products, 2015. <https://thehia.org/HIAhemppressreleases/4010402#>.
- Australian Government Department of Health Therapeutic Goods Administration. Available from: <https://www.tga.gov.au/access-medicinal-cannabis-products-1>.
- Axelsson, M., Sjøvall, J., Gustafsson, B.E., Setchell, K.D., 1982. Origin of lignans in mammals and identification of a precursor from plants. *Nature*, 298, 659–670.
- Balistreri, E., Garcia-Gonzalez, E., Selvi, E., Akhmetshina, A., Palumbo, K., Lorenzini, S., Maggio, R., Lucattelli, M., Galeazzi, M., Distler, J.W.H., 2011. The cannabinoid WIN55, 212-2 abrogates dermal fibrosis in scleroderma bleomycin model. *Ann. Rheum. Dis.* 70, 695–699.
- Beautymunsta, 2018. 12 Benefits of Hemp Seed Oil for Skin. www.beautymunsta.com.
- Beautyglimpse blog, 2018. Accessed. <http://www.beautyglimpse.com/incredible-benefits-skin-care-flaxseed-oil>. (Accessed 1 November 2018).
- Bickis, I., 2015. Canada's Hemp Industry Growing Fast, but Competition Looms. The Canadian Press. <https://www.thestar.com/business/2015/07/10/canadas-hemp-industry-is-growing-fast-but-competition-looms.html>.
- Bonn-Miller, M.O., Loflin, M.J.E., Thomas, B.F., Marcu, J.P., Hyke, T., Vandrey, R., 2017. Labeling accuracy of cannabidiol extracts sold online. *JAMA* 318, 1708–1709.
- Burstein, S., 2015. Cannabidiol (CBD) and its analogs: a review of their effects on inflammation. *Bioorg. Med. Chem.* 23, 1377–1385.
- Callaway, J.C., 2004. Hempseed as a nutritional resource: an overview. *Euphytica* 65–72.

- Callaway, J.C., Pate, D.W., 2009. Hempseed oil. In: Moreau, R., Kamal-Eldin, A. (Eds.), *Gourmet and Health-Promoting Specialty Oils*. AOCS Press, Urbana, IL, pp. 185–214.
- Callaway, J.C., Tennila, T., Pate, D.W., 1996. Occurrence of “omega-3” stearidonic acid (cis-6,9,12,15 octadecatetraenoic acid) in hemp (*Cannabis sativa L.*) seed. *Journal of International Hemp Association* 3 (2), 61–63.
- Carus, M., 2017. *The European Hemp Industry: Cultivation, Processing and Applications for Fibres, Shives, Seeds and Flowers*. EIHA, p. 2017. http://eiha.org/media/2017/12/17-03_European_Hemp_Industry.pdf.
- Cherney, J.H., Small, E., 2016. Industrial hemp in north America: production, politics and potential. *Agronomy* 6 (4), 58. <https://doi.org/10.3390/agronomy6040058>.
- Chung, M.W.Y., Lei, B., Li-Chan, E.C.Y., 2005. Isolation and structural characterization of the major protein fraction from NorMan flaxseed (*Linum usitatissimum L.*). *Food Chem.* 271–279.
- Czemplik, M., Korzun-Chłopicka, U., Szatkowski, M., Działo, M., Szopa, J., Kulma, A., 2017. Optimization of Phenolic Compounds Extraction from Flax Shives and Their Effect on Human Fibroblasts; Evidence-Based Complementary and Alternative Medicine. Article ID 3526392. <https://doi.org/10.1155/2017/3526392>.
- del Río, C., Navarrete, C., Collado, J.A., Bellido, M.L., Gómez-Cañas, M., Pazos, M.R., Fernández-Ruiz, J., Pollastro, F., Appendino, G., Calzado, M.A., Cantarero, I., Muñoz, E., 2016. The cannabinoid quinol VCE-004.8 alleviates bleomycin-induced scleroderma and exerts potent antifibrotic effects through peroxisome proliferator-activated receptor- γ and CB2 pathways. *Sci. Rep.* 18 (6), 21703.
- Derakhshan, N., Kazemi, M., 2016. Cannabis for refractory psoriasis-high hopes for a novel treatment and a literature review. *Curr. Clin. Pharmacol.* 11, 146–147.
- Dev, D.K., Quensel, E., 2006. Preparation and functional properties of linseed protein products containing differing levels of mucilage. *J. Food Sci.* 53 (6), 1834–1837.
- Dev, D.K., Sienkiewicz, T., Quensel, E., Hansen, R., 1986. Isolation and partial characterization of flaxseed proteins (*Linum usitatissimum L.*). *Nahrung* 30, 391–393.
- Devinsky, O., 2014. Cannabidiol: pharmacology and potential therapeutic role in epilepsy and other neuropsychiatric disorders. *Epilepsia* 55, 791–802.
- Dewey, L.H., 1914. *Hemp*. USDA 1913 Yearbook. United State Department of Agriculture, Government Printing Office, pp. 283–346.
- Dribnenki, J.C.P., Green, A.G., 1995. Linola™ “947” low linolenic acid flax. *Can. J. Plant Sci.* 75, 201–202.
- Dunford, N.T., 2015. Hemp and flaxseed oil: properties and application for use in food. In: Talbot, G. (Ed.), *Specialty Oils and Fats in Food and Nutrition*. Woodhead Publishing Ltd, Oxford, pp. 39–63.
- EU Regulation 1307/2013, 2018. <https://publications.europa.eu/en/publication-detail/-/publication/53e914a8-4837-4ed5-aa6d-c94e5cd2f7db/language-en/format-PDF/source-search>.
- Fasinu, P.S., et al., 2016. Current status and prospects for cannabidiol preparations as new therapeutic agents. *Pharmacotherapy* 36, 781–796.
- Frassinettia, S., Mocciaa, E., Caltavuturoa, L., Gabrielea, M., Longoa, V., Bellania, L., Giorgic, G., Giorgettia, L., 2018. Nutraceutical potential of hemp (*Cannabis sativa L.*) seeds and sprouts. *Food Chem.* 262, 56–66.

- Guzmán Gutiérrez, S., Gomez-Cansino, R., Garcia-Zebadua, J., Jimenez-Perez, N., Reyes-Chilpa, R., 2012. Antidepressant activity of *Litsea glaucescens* essential oil: identification of B-pinene and linalool as active principles. *J. Ethnopharmacol.* 143, 673–679.
- Guzmán Gutiérrez, S., Bonilla-Jaime, H., Gomez-Cansino, R., Reyes-Chilpa, R., 2015. Linalool and β -pinene exert their antidepressant-like activity through the monoaminergic pathway. *Life Sci.* 128 <https://doi.org/10.1016/j.lfs.2015.02.021>.
- Goyal, A., Sharma, V., Upadhyay, N., Gill, S., Sihag, M., 2014. Flax and flaxseed oil: an ancient medicine & modern functional food. *J Food Sci Technol* 51 (9), 1633–1653.
- Hall, C., Tulbek, M.C., Xu, Y., 2006. Flaxseed. *Adv. Food Nutr. Res.* 51, 1–97.
- Halle, I., Schöne, F., 2013. Influence of rapeseed cake, linseed cake and hemp seed cake on laying performance of hens and fatty acid composition of egg yolk. *J. Cons. Protect. Food Safety (J. Verbr. Lebensm.)* 8, 185–193.
- Hanuš, L.O., Meyer, S.M., Muñoz, E., Tagliatalata-Scafati, O., Appendino, G., 2016. Phytocannabinoids: a unified critical inventory, (Review Article). *Nat. Prod. Rep.* 33, 1357–1392. <https://doi.org/10.1039/C6NP00074F>.
- Hazekamp, A., 2018. The trouble with CBD oil. *Med. Cannabis. Cannabinoids* 1, 65–72.
- Hazekamp, A., Fishedick, J.T., Diez, M.L., Lubbe, A., Ruhaak, R.L., 2010. Chemistry of Cannabis in *Comprehensive Natural Products Chemistry II*. Elsevier Ltd., Edition, pp. 1033–1084.
- Health Canada, 2017. About hemp and Canada's hemp industry. <https://www.canada.ca/en/health-canada/services/drugs-medication/cannabis/producing-selling-hemp/about-hemp-canada-hemp-industry.html>.
- Healthline, 2018. Hemp Oil for Skin. www.healthline.com.
- Hessle, A., Eriksson, M., Nadeau, E., Turner, T., Johansson, B., 2008. Cold-pressed hempseed cake as a protein feed for growing cattle. *Acta Agric. Scand. Sect. A Anim. Sci.* 58, 136–145.
- Hemp Industries Association, 2016. 2015 Annual Retail Sales for Hemp Products accessed. <https://thehia.org/HIAhempnewsreleases/4010402#>. accessed Nov 1, 2018.
- Hill, A.J., Williams, C.M., Whalley, B.J., Stephens, G.J., 2012. Phytocannabinoids as novel therapeutic agents in {CNS} disorders. *Pharmacol. Ther.* 133, 79–97.
- Hippiebutter, 2017. The benefits of using hemp soap. www.hippiebutter.com.
- Hosseinian, F.S., Rowland, G.G., Bhirud, P.R., Dyck, J.H., Tyler, R.T., 2004. Chemical composition and physicochemical and hydrogenation characteristics of high-palmitic acid solin (low-linolenic acid flaxseed) oil. *J. Am. Oil Chem. Soc.* 81 (2), 185–188.
- House, J.D., Neufeld, J., Leson, G., 2010. Evaluating the quality of protein from hemp seed (*Cannabis sativa L.*) products through the use of the protein digestibility-corrected amino acid score method. *J. Agric. Food Chem.* 58, 11801–11807. <http://www.beautyglimpse.com/incredible-benefits-skin-care-flaxseed-oil>.
- Iffland, K., Grotenhermen, F., 2017. An update on safety and side effects of cannabidiol: a review of clinical data and relevant animal studies. *Cannabis and Cannabinoid. Res.* 2, 139–154.
- Is CBD Legal in My Country? – the Legal Status of CBD in Europe for, 2018. <https://www.daiba.uk/blog/is-cbd-legal-in-my-country-europe/>.
- Jing, M., Zhao, S., House, J.D., 2017. Performance and tissue fatty acid profile of broiler chickens and laying hens fed hemp oil and Hemp Omega™. *Poult. Sci.* 96, 1809–1819.
- Johnson, 2017. Hemp as an Agricultural Commodity. Congressional Research Service, Washington, DC, 7-5700. www.crs.gov. RL32725.
- Kankaanpää-Anttila, B., Anttila, M., 1999. Flax Preparation, its Use and Production US5, vol. 925, p. 401 patent application.

- Kaur, P., Waghmare, R., Kumar, V., et al., 2018. Recent advances in utilization of flaxseed as potential source for value addition. *Oilseeds Fats Crops Lipids (OCL)* 25 (3), A34. <https://www.ocl-journal.org/articles/ocl/pdf/2018/03/ocl170043.pdf>.
- Khan, R.U., Fazil-e-Raziq, D, Chand, N., Anwar, H., Naz, S., Farooqi, F.A., Manzoor, M.N., 2009. Effect of *Cannabis sativa* fortified feed on muscle growth and visceral organs in broiler chicks. *Int. J. Biol. Biotechnol.* 6 (3), 179–182.
- Kolodziejczyk, P.P., Fedec, P., 1995. Processing flaxseed for human consumption. In: Cunnance, S.C., Thompson, L.U. (Eds.), *Flaxseed in Human Nutrition*. AOCS Press, Champaign, IL.
- Kolodziejczyk, P.P., Ozimek, L., Kozłowska, J., 2012. The application of flax and hemp seeds in food, animal feed, health and cosmetics. In: Kozłowski, R. (Ed.), *Handbook of Natural Textile Fibres: vol. 2: Types, Properties and Factors Affecting Breeding and Cultivation*. Woodhead Publishing Limited, Cambridge, UK, pp. 329–366.
- Korus, J., Witczak, M., Ziobro, R., Juszcak, L., 2017. Hemp (*Cannabis sativa* subsp. *sativa*) flour and protein preparation as natural nutrients and structure forming agents in starch based gluten free bread. *LWT - Food Science and Technology* 84, 143–150.
- Kozłowska, J., Biskupski, M., Gromek, M., Wezyk, S., Poltowicz, K., 2009. The effect of addition of flaxseed oil to the diet of laying hens housed in the different housing system on the nutritional value of the eggs. In: Kozłowski, R., Zaikov, G., Pudel, F. (Eds.), *Renewable Resources: Obtaining, Processing and Applying*. Nova Science Publishers, Hauppauge, NY, pp. 95–102.
- Laate, E.A., 2012. Industrial Hemp Production in Canada. [https://www1.agric.gov.ab.ca/\\$department/deptdocs.nsf/all/econ9631/\\$file/Final - Industrial Hemp Production in Canada - June 25 2012.pdf?OpenElement](https://www1.agric.gov.ab.ca/$department/deptdocs.nsf/all/econ9631/$file/Final - Industrial Hemp Production in Canada - June 25 2012.pdf?OpenElement). [https://www1.agric.gov.ab.ca/\\$department/deptdocs.nsf/all/econ9631/\\$file/Final - Industrial Hemp Production in Canada - June 25 2012.pdf?OpenElement](https://www1.agric.gov.ab.ca/$department/deptdocs.nsf/all/econ9631/$file/Final - Industrial Hemp Production in Canada - June 25 2012.pdf?OpenElement).
- Legal Medical and Recreational Marijuana in U. States and DC, 2018. In: <https://marijuana.procon.org/view.resource.php?resourceID=006868>.
- Liu, J., Shin, Y., Tse, T.J., Wang, Y., Reaney, M., 2018. Flaxseed gum a versatile natural hydrocolloid for food and non-food applications. *Trends Food Sci. Technol.* 75, 146–157.
- Lush Hand Made Cosmetics, 2018. Ingredients Linseed Mucilage. Accessed. <https://uk.lush.com/ingredients/linseed-mucilage>. (Accessed 8 December 2018).
- Mamone, G., Gianluca Picariello, G., Ramondo, A., Nicolai, M.A., Ferranti, P., 2018. Production, digestibility and allergenicity of hemp (*Cannabis sativa* L.) protein isolates. *Food Res. Int.* <https://doi.org/10.1016/j.foodres.2018.09.017>.
- Manitoba Harvest Hemp Foods, 2017. <https://manitobaharvest.com/>.
- Marambe, P.W.M.L.H.K., Shand, P.J., Wanasundara, P.K.J.P.D., 2008. An in-vitro investigation of selected biological activities of hydrolysed flaxseed (*Linum usitatissimum* L.) proteins. *J. Am. Oil Chem. Soc.* 85 (12), 1155–1164.
- Marquart, S., Zerr, P., Akhmetshina, A., Palumbo, K., Reich, N., Tomcik, M., Horn, A., Dees, C., Engel, M., Zwerina, J., Distler, O., Schett, G., Distler, J.H., 2010. Inactivation of the cannabinoid receptor CB1 prevents leukocyte infiltration and experimental fibrosis. *Arthritis Rheum.* 62, 3467–3476.
- Martin, K.I., Glaser, D.A., 2011. Cosmeceuticals: the new medicine of beauty. *Mo. Med.* 108 (1), 60–63.
- Miller Cavitch, S., 1997. *The Soapmaker's Companion: A Comprehensive Guide with Recipes, Techniques and Know-How*. Storey Publishing, LLC, p. 1849.

- Montserrat-de la Paz, S., Marín'Aguilar, F., García Giménez, M.D., Fernández-Arche, M.A., 2014. Hemp (*Cannabis sativa L.*) seed oil: analytical and phytochemical characterization of the unsaponifiable fraction. *J. Agric. Food Chem.* 62 (5), 1105–1110.
- Muñoz, E., 2018. Cannabinoids and Inflammatory Skin Diseases. *Fundacion Canna*. <https://www.fundacion-canna.es/en/cannabinoids-and-inflammatory-skin-diseases>.
- Muir, A.D., Westcott, N.D., 2003. Flaxseed constituents and human health. Ch 12. In: Muir, A.D., Westcott, N.D. (Eds.), *Flax: The Genus Linum*. Taylor and Francis, London, pp. 243–251.
- Multari, S., Neacsu, M., Scobbie, L., Cantlay, L., Duncan, G., Vaughan, N., Stewart, D., Russell, W.R., 2016. Nutritional and phytochemical content of high-protein crops. *J. Agric. Food Chem.* 64 (41), 7800–7811.
- Mustafa, A.F., McKinnon, J.J., Christensen, D.A., 1999. The nutritive value of hemp meal for ruminants. *Can. J. Anim. Sci.* 79, 91–95.
- New Zealand Government Ministry of Health, 2018. NZ Medicinal Cannabis accessed. <https://www.health.govt.nz/our-work/regulation-health-and-disability-system/medicines-control/medicinal-cannabis>. (Accessed 30 October 2018).
- Novak, J., Zitterl-Eglseer, K., Deans, S.G., Franz, C.M., 2001. Essential oils of different cultivars of *Cannabis sativa L.* and their antimicrobial activity. *Flavour Fragrance J.* 16, 259–262.
- Nuutinen, T., 2018. Medicinal properties of terpenes found in *Cannabis sativa* and *Humulus lupulus*. *Eur. J. Med. Chem.* 157, 198–228. <https://doi.org/10.1016/j.ejmech.2018.07.076>.
- Oláh, A., Tóth, B.I., Borbíró, I., Sugawara, K., Szöllösi, A.G., Czifra, G., Pál, B., Ambrus, L., Klopper, J., Camera, E., Ludovici, M., Picardo, M., Voets, T., Zouboulis, C.C., Paus, R., Bíró, T., 2014. Cannabidiol exerts sebostatic and anti-inflammatory effects on human sebocytes. *J. Clin. Invest.* 124 (9), 3713–3724. <https://doi.org/10.1172/jci64628>.
- Oláh, A., Markovics, A., Szabo-Papp, Szabo, P.T., Stott, C., Zouboulis, C.C., Biro, T., 2016. Differential effectiveness of selected non-psychotropic phytocannabinoids on human sebocyte functions implicates their introduction in dry/seborrhoeic skin and acne treatment. *Exp. Dermatol.* 25, 701–707.
- Oomah, B.D., Mazza, G., 1993. Flaxseed proteins: a review. *Food Chem.* 48, 109–114.
- Oomah, B.D., Mazza, G., 1997. Effect of dehulling on chemical composition and physical properties of flaxseed. *LWT – Food Sci. Technol.* 30 (2), 135–140.
- Peacenaturals, 2018. Strain specific cannabis oils. www.peacenaturals.com.
- Pengilly, N., 2003. Traditional food and medicinal use of flaxseed, Chapter 13. In: Muir, A.D., Westcott, N.D. (Eds.), *Flax the Genus Linum*. Taylor and Francis, London, pp. 252–267.
- Persistence Market Report, 2018. North America Market Study on Flaxseed: U.S. and Canada Industry Analysis and Forecast 2016 – 2022; PMRREP 10517.
- Peschel, W., 2016. Quality control of traditional cannabis tinctures: pattern, markers, and stability. *Sci. Pharm.* 84, 567–584. <https://doi.org/10.3390/scipharm84030567>.
- Pisanti, S., Malfitano, A.M., Ciaglia, E., Lamberti, A., Ranieri, R., Cuomo, G., Abate, M., Fagiana, G., Proto, M.C., Fiore, D., Laezza, C., Bifulco, M., 2017. Cannabidiol: State of the Art and New Challenges for Therapeutic Applications *Pharmacology & Therapeutics*, vol. 175, pp. 133–150.
- Pojić, M., Mišan, A., Sakač, M., Dapčević Hadnađev, T., Šarić, B., Milovanović, I., Hadnađev, M., 2014. Characterization of byproducts originating from hemp oil processing. *J. Agric. Food Chem.* 62 (51), 12436–12442.
- Prociuk, M.A., Edell, A.L., Richard, M.N., Gavel, N.T., Ander, B.P., Dupasquier, C.M., Pierce, G.N., 2008. Cholesterol-induced stimulation of platelet aggregation is prevented by a hempseed-enriched diet. *Can. J. Physiol. Pharmacol.* 86 (4), 153–159.

- Richard, M.N., Ganguly, R., Steigerwald, S.N., Al-Khalifa, A., Pierce, G.N., 2007. Dietary hempseed reduces platelet aggregation. *J. Thromb. Haemost.* 5, 424–425.
- Rinaldi, A., 2008. Healing beauty? More biotechnology cosmetic products that claim drug-like properties reach the market. *EMBO Rep.* 9 (11), 1073–1077. <https://doi.org/10.1038/embor.2008.200>.
- Russo, E.B., 2011. Taming THC: potential cannabis synergy and phytocannabinoid-terpenoid entourage effects. *Br. J. Pharmacol.* 163 (7), 1344–1364.
- Russo, E.B., Jiang, H.E., Li, X., Sutton, A., Carboni, A., del Bianco, F., Mandolino, G., Potter, D.J., Zhao, Y.X., Bera, S., Zhang, Y.B., Lü, E.G., Ferguson, D.K., Hueber, F., Zhao, L.C., Liu, C.J., Wang, Y.F., Li, C.S., 2008. Phytochemical and genetic analyses of ancient cannabis from Central Asia. *J. Exp. Bot.* 59 (15), 4171–4182.
- Rustichelli, C., Ferioli, V., Baraldi, M., Zanolini, P., Gamberini, 1988. Analysis of cannabinoids in fiber hemp plant varieties (*Cannabis sativa L.*) by high-performance, liquid chromatography. *Chromatographia* 48 (3–4), 215–222.
- Schluttenhofe, C., Yuan, L., 2017. Challenges towards revitalizing hemp: a multifaceted crop. *Trends Plant Sci.* 22, 917–929.
- Schwab, U.S., Callaway, J.C., Erkkila, A.T., Gynther, J., Uusitupa, M.I.J., Jarvinen, T., 2006. Effects of hempseed and flaxseed oils on the profile of serum lipids, serum total and lipoprotein lipid concentrations and haemostatic factors. *Eur. J. Nutr.* 45, 470–477.
- Shahid, S., Chand, N., Khan, R.U., Suhail, S.M., Khan, N.A., 2015. Alternations in cholesterol and fatty acids composition in egg yolk of Rhode Island Red × Fyoumi hens fed with hemp seeds (*Cannabis sativa L.*). *J. Chem.* Article ID 362936 <https://www.fda.gov/NewsEvents/PublicHealthFocus/ucm484109.htm>.
- Sim, J.S., Qi, G.H., 1995. Designing poultry products using flaxseed. In: Cunnane, S.C., Thompson, L.U. (Eds.), *Flaxseed in Human Nutrition*. AOCS Press, Champaign, IL, pp. 315–333.
- Simopoulou, A.P., 1999. Essential fatty acids in health and chronic disease. *Am. J. Clin. Nutr.* 70 (Suppl), 560S–569S.
- Simopoulou, A.P., 2002. The importance of the ratio of omega-6/omega-3 essential fatty acids. *Biomed. Pharmacother.* 56 (8), 365–379.
- Singh, D., Fisher, J., Shagalov, D., Varma, A., Siegel, D.M., 2018. Dangerous plants in dermatology: legal and controlled. *Clin. Dermatol.* 36, 399–419. <https://doi.org/10.1016/j.clindermatol.2018.03013>.
- Soliman, E., Ladin, D.A., Van Dross, R., 2016. Cannabinoids as therapeutics for non-melanoma and melanoma skin cancer. *J. Dermatol. Clin. Res.* 4, 1069. Available at: <http://sonyadakar.com/blog/facial-oil-5-reasons-your-skin-needs-it>.
- Sonya Dakar Com, 2018. Accessed. <http://sonyadakar.com/blog/facial-oil-5-reasons-your-skin-needs-it>. (Accessed 1 November 2018).
- Swiss Government. <https://www.admin.ch/opc/fr/official-compilation/2011/2595.pdf>, 2011.
- Teh, S.-S., Birch, E., 2013. Physicochemical and quality characteristics of cold-pressed hemp, flax and canola seed oils. *J. Food Compos. Anal.* 30, 26–31. <https://doi.org/10.1016/j.jfca.2013.01.004>.
- Udenigwe, C.C., Lin, Y.S., Hou, W.C., Aluko, R.E., 2009. Kinetics of the inhibition of renin and angiotensin I-converting enzyme by flaxseed protein hydrolysate fractions. *J. Funct. Foods* 1, 199–207.
- US FDA. Warning Letters and Test Results for Cannabidiol-Related Products. <https://www.fda.gov/news-events/public-health-focus/warning-letters-and-test-results-cannabidiol-related-products>.

- USDA Nutrition Data Base, 2018. <https://ndb.nal.usda.gov/ndb/foods/show/12012?n1=%7BQv%3D1%7D&fgcd=&manu=&lfacet=&count=&max=25&sort=default&qlookup=hemp+seeds&offset=&format=Full&new=&measureby=&Qv=1&ds=SR&qt=&qp=&qa=&qn=&q=&ing=>.
- USPATENT6998466, 2006. Process for Extracting Flax Protein Concentrate from Flax Meal USA Patent Application. USDA Nutrition Data Base. <https://ndb.nal.usda.gov/ndb/foods/show/12220?fgcd=&manu=&format=&count=&max=25&offset=&sort=default&order=asc&qlookup=Seeds%2C+flaxseed&ds=SR&qt=&qp=&qa=&qn=&q=&ing=>.
- Vaisey-Genser, M., Morris, D.H., 2003. Introduction: history of cultivation and uses of flaxseed. Chapter 1. In: Flax: The Genus *Linum*. Taylor and Francis, London, pp. 1–21.
- US Patent Appl. 2015/0297556. Transdermal cannabinoid patch. <https://patentimages.storage.googleapis.com/48/01/da/53903f2afef736/US20150297556A1.pdf>.
- Veselinovic, M., Vasiljevic, D., Vucic, V., Arsic, A., Petrovic, S., Tomic-Lucic, A., Savic, M., Zivanovic, S., Stojic, V., Jakovljevic, V., 2017. Clinical benefits of n-3 PUFA and γ -linolenic acid in patients with rheumatoid arthritis. *Nutrients* 9 (4), 325.
- Vonapartis, E., Aubin, M.P., Seguin, P., Mustafa, A.F., Charron, J.B., 2015. Seed composition of ten industrial hemp cultivars approved for production in Canada. *J. Food Compos. Anal.* 39, 8–12.
- Vote-Hemp-2017-US-Hemp-Crop-Report.pdf, 2018. <https://www.votehemp.com/wp-content/uploads/2018/09/Vote-Hemp-2017-US-Hemp-Crop-Report.pdf>.
- Wallace, H., 2017. The Ultimate Guide to Phytocannabinoids for Horses. American Horse Publications. <https://www.timidrider.com/pcr-horses/>.
- Webmd Reviews, 2018. Flaxseed Information. Consulted Oct 29. www.webmd.com.
- Westcott, N.D., Muir, A.D., 2003. Chemical studies on the constituents of *Linum* spp. Flax. In: Muir, A.D., Westcott, N.S. (Eds.), *Flax: The Genus Linum*. Taylor and Francis, London, pp. 55–73.
- WHO Report, 2017. Report Cannabidiol (compound of cannabis) accessed. <http://www.who.int/features/qa/cannabidiol/en/>. (Accessed 30 October 2018).
- WiseGuys Report, 2018. Global Hemp-Based Foods Market Insights. Forecast to 2025 at. <https://www.wiseguyreports.com/reports/3449202-global-hemp-based-foods-market-insights-forecast-to-2025>. WGR3449202.
- Wollenberg, A., Seba, A., Antal, A.S., 2014. Immunological and molecular targets of atopic dermatitis treatment. *Br. J. Dermatol.* 170 (Suppl. 1), 7–11. <https://doi.org/10.1111/bjd.12975>. Epub 2014 May.
- Wu, G., Meininger, C.J., 2002. Regulation of nitric oxide synthesis by dietary factors. *Annu. Rev. Nutr.* 22, 61–86.
- Yan, X., Tang, J., Passos, C., Nurisso, A., Simões-Pires, C., Ji, M., Lou, H., Fan, P., 2015. Characterization of lignanamides from hemp (*Cannabis sativa*) seed and their antioxidant and acetylcholine esterase inhibitory activities. *J. Agric. Food Chem.* 63 (49), 10611–10619. <https://doi.org/10.1021/acs.jafc.5b05282>.
- Zhou, Y.F., Wang, S.S., Ji, J., Lou, H.X., Fan, P.H., 2018. Chemical constituents of hemp (*Cannabis sativa* L.) seed with potential antineuroinflammatory activity. *Phytochem. Lett.* 23, 57–61.

Further reading

- Alexander, P., Brown, C., Arneth, A., Finnigan, J., Moran, D., Rounsevel, M.D.A., 2017. Losses, inefficiencies and waste in the global food system. *Agric. Syst.* 153, 190–20.
- Black, H.S., Rhodes, L.E., 2006. The potential of omega 3 fatty acids in the prevention of non-melanoma skin cancer. *Cancer Detect. Prev.* 30 (3), 224–232.
- Callaway, J., Schwab, U., Harvima, I., Halonen, P., Mykkänen, O., Hyvönen, P., Järvinen, T., 2005. Efficacy of dietary hempseed oil in patients with atopic dermatitis. *J. Dermatol. Treat.* 16, 87–94.
- Chuquilin, M., Alghalith, Y., Fernandez, K., 2016. Neurocutaneous disease. *J. Am. Acad. Dermatol.* 74, 197–212.
- Cosgrove, M.C., Franco, O.H., Granger, S.P., Murray, P.G., Mayes, A.E., 2007. Dietary nutrient intakes and skin-aging appearance among middle-aged American women. *Am. J. Clin. Nutr.* 86 (4), 1225–1231.
- <https://thedermblog.com/2008/06/06/flaxseed-oil-and-your-skin>, 2018.
- Dev, D.K., Quensel, E., 1989. Functional properties of linseed protein products containing different levels of mucilage in selected food systems. *J. Food Sci.* 54, 183–186.
- Gaffal, E., Cron, M., Glodde, N., Tüting, T., 2013. Antiinflammatory activity of topical THC in DNFB-mediated mouse allergic contact dermatitis, independent of CB1 and CB2 receptors. *Allergy* 68, 994–1000.
- Gay, C., 1864. ‘Plantas y arboles industriales’ in: *Historia física y política de Chile agricultura*. Casa del Autor, Paris, pp. 93–96.
- Glodde, N., Jakobs, M., Bald, T., Tüting, T., Gaffal, E., 2015. Differential role of cannabinoids in the pathogenesis of skin cancer. *Life Sci.* 138, 35–40.
- Ingredients Linseed Mucilage, 2018. <https://uk.lush.com/ingredients/linseed-mucilage>.
- James, M.J., Ursin, V.M., Cleland, L.G., 2003. Metabolism of stearidonic acid in human subjects: comparison with other metabolism of other n-3 fatty acids. *Am. J. Clin. Nutr.* 77, 1140–1145.
- McDaniel, J.C., Belury, M., Ahijewych, K., Blakely, W., 2008. Omega 3 fatty acids effects on wound healing. *Wound Repair Regen.* 16 (3), 337–345.
- Mourot, J., Guillevic, M., 2015. Effect of introducing hemp oil into feed on the nutritional quality of pig meat. *OCL – Oilseeds Fats Crops Lipids* 22 (6), D612. <https://doi.org/10.1051/ocl/2015035>.
- Parikh, M., Neticadan, T., Pierce, G.N., 2018. Flaxseed: its bioactive components and their cardiovascular benefits. Review: mining natural products for cardiovascular benefits. *Am. J. Heart Circ. Physiol.* 314, H146–H159.
- Takemura, N., Takahashi, K., Tanaka, H., Ihara, Y., Ikemoto, A., Fujii, Y., Okuyama, H., 2002. Dietary but not topical alpha linolenic acid suppressed UVB-induced skin injury in hairless mic when compared with linoleic acid. *Photochem. Photobiol.* 76 (6), 657–663.
- These Flax Seed Benefits for Hair and Skin Are the Perfect Way for Vegetarians to Get Their Omega-3s, January 12 2015. <https://www.bustle.com/articles/56520/these-flax-seed-benefits-are-perfect-way-for-vegetarians-to-get>.
- Thompson, L.U., Rickard, S.E., Orcheson, L.J., Seidl, M.M., 1996. Flaxseed and its lignans and oil components reduce mammary tumor growth at a late stage of carcinogenesis. *Carcinogenesis* 17, 1373–1376.

- Wilkins, J., Williamson, E., 2007. Cannabinoids inhibit human keratinocytes proliferation through a non CB1#CB2 mechanism and have a potential therapeutic value in the treatment of psoriasis. *J. Dermatol. Sci.* 45, 87–92.
- Womanitely, 2018. Beauty; 7 miraculous beauty uses of flax oil. <https://womanitely.com>.
- Zhou, Y.F., Wang, S.S., Ji, J., Lou, H.X., Fan, P.H., 2018. Hemp (*Cannabis sativa L.*) seed phenylpropionamides composition and effects on memory dysfunction and biomarkers of neuroinflammation induced by lipopolysaccharide in mice. *ACS Omega* 3, 15988–15995.

Natural fibres for paper and packaging

18

Raphaël Passas

University of Grenoble Alpes, CNRS, Grenoble INP (Institute of Engineering, University of Grenoble Alpes), LGP2, Grenoble, France

18.1 Introduction

According to [ISO 4046 \(1978\)](#) standard, boards and papers are materials built by deposition of vegetal, mineral, animal or synthetic fibres, or their mixtures, from a fluid suspension onto a suitable forming device, with or without the addition of other substances. Furthermore a fibre is frequently defined as an object with a length/width ratio over 100 times ([Reis et al., 2006](#)). This chapter will focus only on the vegetal fibres that means that animal fibres (like wool, silk), mineral fibres (like asbestos) or all the others polymeric fibres will not be discussed even if they have some interesting properties.

This chapter is divided in three main parts. The first one is dealing with the fibrous resources which are the wood fibres, the annual plants fibres and also a part regarding the agriculture residues.

The part 3 begins with the pulping processes description including few words about the steam explosion. Then, the papermaking process is resumed with a specific subpart about the particularity induced by the use of annual plant fibres.

The last part shows some potential opportunities for the pulp and paper business based on environmental considerations and on new consumption practices.

18.2 Available natural raw materials for paper and packaging

Plants are eukaryotic multicellular organisms which reproduce with spores or sex cells. Furthermore they have more or less rigid cell walls surrounded the cells. They are able to produce their own food from inorganic matter by photosynthesis because they contain chlorophyll even if few plants are living as parasitic and live off other plants. The classification of the plants is presented on [Fig. 18.1](#) for a first approach. About 250,000 species belong to the spermatophyte branch in the world. Gymnosperms correspond to only 1000 species. These conifers have seeds which are not enclosed at the surface or at the tip of an appendage (nude seeds). They are often called

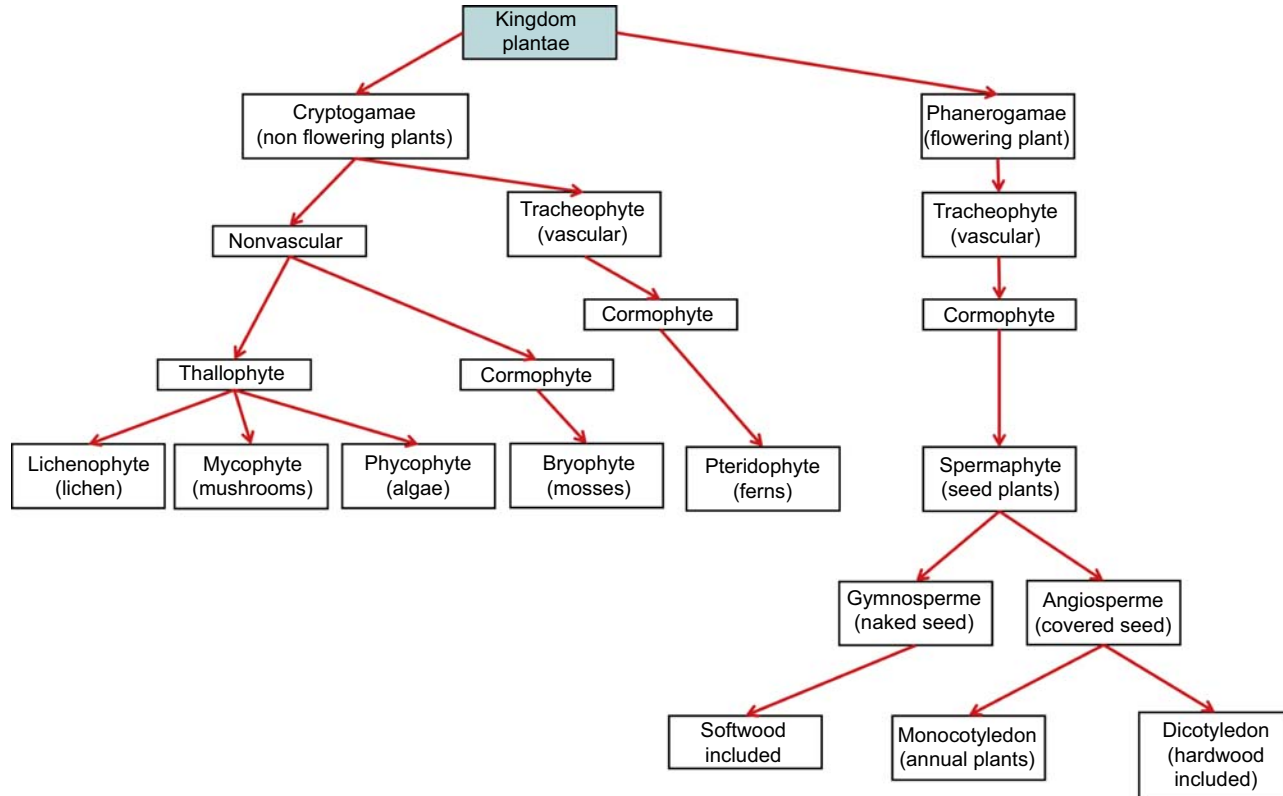

Figure 18.1 Plants' classification.

softwood in the pulp and paper field. Angiosperms have, by definition, their seeds included within the structure of a fruit and they represent about 240,000 species (Ozenda, 2000). Most of them (~ 180 000) are monocotyledon and 60,000 other species belong to the dicotyledonous category. Hardwood fibres belong to this last group.

Table 18.1 indicates where fibres are located in the plant: stem leaves, fruits and seeds. Softwood and hardwood fibres come from branches or trunks. Bast fibres are derived from the conducting tissue (phloem) which is located in the inner bark outside the cambium (Tappi standard T 259 sp-05, 2005). According to Isenberg (1967), three kinds of fruit fibres are distinguished depending on where they come from: seeds (cotton), pods (kapok) or husks (coir). Leaf fibre comes from fibre bundles of very long leaves or leaf sheaths of some monocotyledons. Fibres from vascular bundles of some monocotyledons are called grass fibres. The proportion of non-wood fibres is changing according to the year and also the regions.

According to Atchison (1988), 11% of non-wood fibres were used for the world wide paper production. In 2009, Eugropa estimated that wood fibres represent about 95% of fibre used in the pulp and paper industry split up into 53% of primary fibres and 42% of recycled fibres, based on an average recycled fibre yield from recovered paper of about 85%. According to CEPI (2018) for European Paper and board production, 53.7% of fibres come from paper recycling.

18.2.1 Wood fibres

When we look at a tree, there are three parts but only two of them are visible. The first one is the trunk or stem which is generally straight and vertical without a lot of branches. The second one is composed of branches, leaves and twigs. The third part is underground and is called the roots. A tree's roots absorb water and nutrients from the soil, store sugar and anchor the tree upright in the ground. All trees have lateral roots that branch into smaller and smaller roots and usually extend horizontally well beyond the branch tips. Large trees typically have roots extending 20–40 m or more from the trunk. The vast majority of the root system is located in the

Table 18.1 Localisation of the fibers in the plant.

Name	Group	Part of the plant used in the pulping process
Cotton (Gossypium)	Angiosperm dicotyledon	Hairs of the seeds
Kapok (Ceiba)	Angiosperm dicotyledon	Seed, fruit
Flax (Linum)	Angiosperm dicotyledon	Stem
Sisal (Agave)	Angiosperm monocotyledon	Leave
Hardwood	Angiosperm dicotyledon	Stem
Softwood	Gymnosperm	Stem

upper 10–30 cm of the soil because the oxygen that roots require to function properly is most abundant there. Each root is covered with thousands of root hairs that make it easier to soak up water and dissolved minerals from the soil. The trunk supports the crown and gives the tree its shape and strength. It is protected by a tough outer covering of bark. The trunk consists of four layers of tissue. These layers contain a network of tubes that runs between the roots and the leaves and acts as the central plumbing system for the tree. These tubes carry water and minerals up from the roots to the leaves, and they carry sugar down from the leaves to the branches, trunk and roots. Fig. 18.2 shows the main parts of the wood sections. Suber and cork have to protect the tree against biochemical or mechanical attacks. The cambial zone is the area where cell divisions take place (Plomion et al., 2001). Cells differentiation takes place according to Fig. 18.3 (Panshin and De Zeeuw, 1964; Beck, 2005). The external outer part is called phloem and produces cork cells.

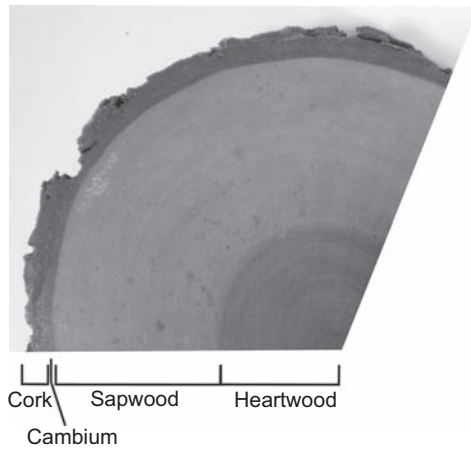

Figure 18.2 Cross-section (transversal view) of a tree trunk.

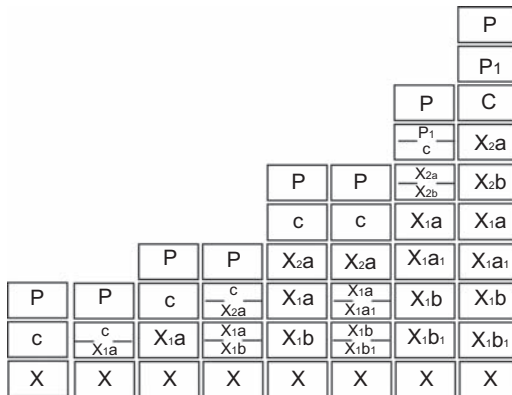

Figure 18.3 Division of the cambial longitudinal initials. C: cambial initials; X: mature xylem cell; X1(a,a1,b,b1), X2(a,b): xylem daughter cells; P and P1: phloem daughter cells.

In the cambium, elaborated sap circulates from the leaves to the root. The inner part is built by only one layer of juvenile cells called initials. The xylem is the internal outer part of the cambial zone and is composed of wood cells. In temperate regions, the annual course of cambial activity is induced by temperature and/or photoperiod (Uggla et al., 2001). Sapwood is the functional part of the tree and is sometimes termed the “living” part of tree even if wood cells die soon after differentiation. It is generally light coloured and is located at the periphery of the wood. Heartwood, located in the middle part of the tree, often has a dark colour. Its role is not yet clearly known but some authors think that it provides long-term resistance to pathogens or provides a mechanical role in tree support as mentioned by Pilate (2008). Annual rings consist of a succession of late wood and early wood cells. Early wood is formed in the growing season (favourable temperature and photoperiod). It contains shorter cells and a lower density resulting from thin-walled tracheids or fibres of large radial diameter. Late wood is formed during late summer or autumn. It has a very high density. Due to narrower lumens, this kind of wood is much less vulnerable to water-stress induced by xylem embolism and so increases the reliability of water conductance. Annual ring arrangement reflects the growth conditions and the climate. The rings are also used for dendrochronology (Schweingruber, 1988; Kuniholm, 2001). To study wood structure, three sections have to be observed. The transversal section (CT) is defined by the plane which is perpendicular to the longitudinal axis of the wood. CLR (radial section) is defined by the plane containing the longitudinal axis. Finally, the tangential section is parallel to the longitudinal axis and perpendicular to the rays. From a global point of view, three main elements are distinguished: fibre, vessel, parenchyma cell (Core et al., 1979).

18.2.1.1 Softwood fibres

Softwood structure is quite simple because there are only three kinds of cells. Tracheids, which are called long fibres by the pulp and papermakers, have two functions. They conduct the sap in the tree but they also ensure the mechanical characteristics of the wood. They are arranged in the longitudinal direction most of the time. At their surface, they have some pits allowing the sap to go from one tracheid to the other (bordered pits) and from one tracheid to parenchyma cells (cross-field pits). To distinguish early wood from late wood it is necessary to care about tracheid width and about cell wall thickness (cf. Table 18.2). Early wood tracheids have a larger lumen and thin wall fibre in order to transport a large amount of sap. For some species, horizontal

Table 18.2 Fibre width and cell wall thickness of softwood.

Species	Fib width (μm)		Cell wall thickness (μm)	
	Earlywood	Latewood	Earlywood	Latewood
Pine	30–39	25–28	2.8–3.4	3.5–4.0
South Pine	40–60	25–33	3.0–4.5	7.0–10

tracheids could be present (e.g. *Pinus Sylvestris*). Rays are in radial direction. They are composed of superimposed parenchyma cells. These could be associated with horizontal tracheids for some species. Parenchyma cells allow the sap conduction in the radial direction and they can store nutrients. Resin canals are not always present. They are oriented either longitudinally or radially and they communicate with each other (Isenberg, 1963). Fig. 18.4 summarises schematically the softwood structure.

18.2.1.2 Hardwood fibres

Hardwood structure is more complex than those of softwood. Sap conduction and mechanical strength are not carried out by the same cells: vessels for the conduction and fibres for the support. Libriform fibres have a longitudinal arrangement and they are supporting cells (Parham and Grey, 1982). Some small, slit like or dot like pits are present. They are sparse and occur commonly scattered over the fibre wall. Their shape is narrowed with pointed ends. Fibre-tracheids exhibit conspicuous bordered pits which are larger and more numerous than those of libriform fibres and tend to be in vertical lines. They are more or less abundant depending on the species. Rays are composed only of parenchyma cells. They could be either homogeneous or heterogeneous depending on the arrangement of parenchyma cells and on their shape (Jane, 1956). Vessels, which perform the sap transportation, are joining end to end to form longitudinal tubes (up to several metres). Their walls are pitted and they may contain spiral thickenings. In wood cross-sections, vessels look like pores.

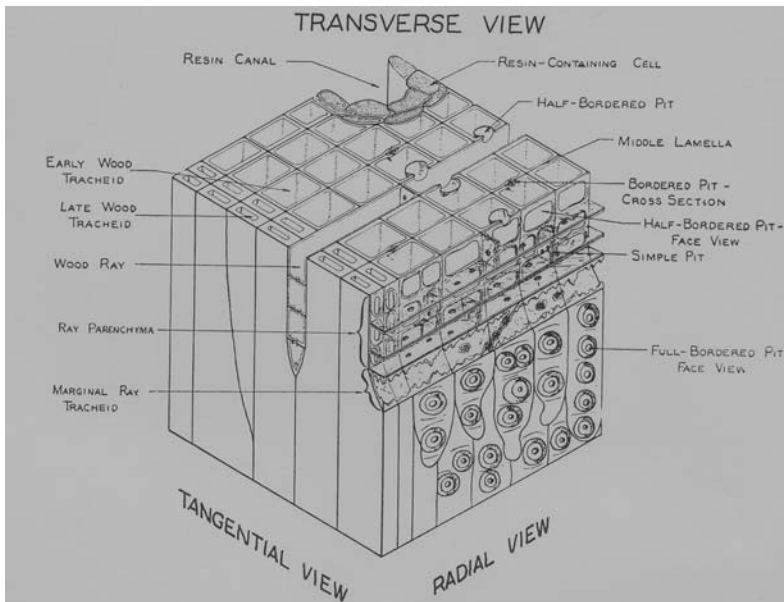

Figure 18.4 Schematic softwood structure (source: Smook, 1992).

Their size and distribution within the growth rings vary with species. According to [Fengel and Wegener \(1984\)](#), three kinds of wood can be distinguished: diffuse-porous wood, where vessels are fairly uniform in size and quite evenly distributed throughout the ring; in semi-ring porous wood, vessels of early wood are somewhat larger or more numerous than those of late wood; and ring porous wood, characterized by much larger early wood vessels than those of summer wood. The block diagram (cf. [Fig. 18.5](#)) shows the cells arrangement in hardwood.

18.2.2 Agriculture residues and annual plants

Due to the increase of the world population, 7.6 billion currently and 11.2 billion in 2100 ([ONU, 2018](#)), more and more agricultural products are needed for a good nutrition of the human beings. After the harvest and specific treatments for food valorization, some parts of plant are considered as residues. As mentioned by [Koopmans and Koppejan \(1997\)](#), residues could be used according to the 6 F's as to know Fuel, Fodder, Fertilizer, Fibre, Feedstock and Further uses (soil conditioner...). Furthermore, it is essential to say that it is very difficult to give global values for the available amount of residues due to important variations according to the season and the geographical localization. An example of such inventories in Eastern Canada was performed by [Helwig et al. \(2002\)](#) who also precise the modalities for the calculation.

Another important point to take into account is the price of this kind of raw materials: if several years ago, residues were free of charge, currently it is no more the case and prices will increase in the future due to their ability to be used to produce fuel.

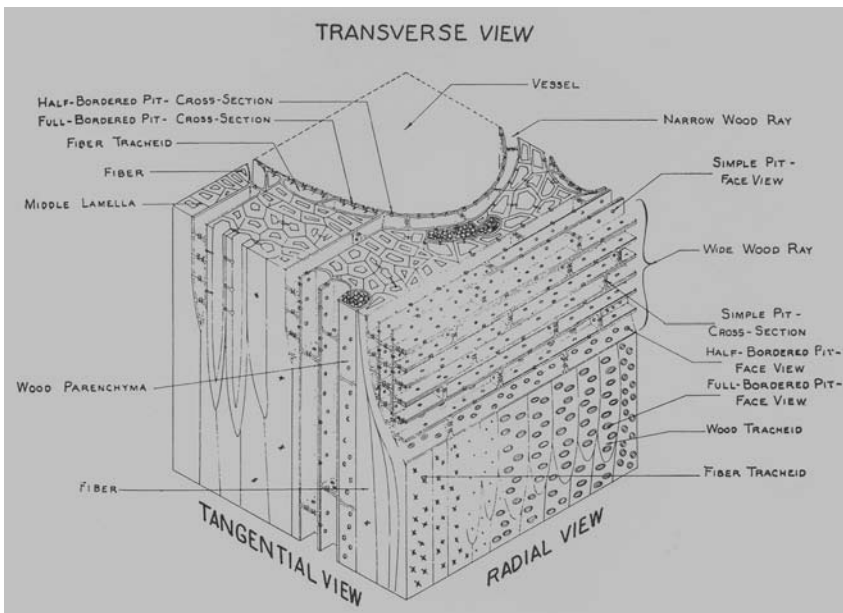

Figure 18.5 Schematic hardwood structure (source: [Smook, 1992](#)).

In the literature a lot of article could be found about the use of residues and annual plants for pulp production in order to be included in the fibre furnish composition of paper. An exhaustive list is impossible to establish due to the big amount of vegetal growing at the Earth's surface.

In this part, we will discuss about the fibre structure of only few plants: grass fibre (wheat), bast fibre (flax), grass fibres (esparto), leaf fibres (Sisal, abaca) and fruit fibres (cotton) according to Ilvessalo-Pfäffli's classification (Ilvessalo-Pfäffli, 1995).

Wheat is a typical case for the grass family. Its stem is based on successive cylindrical parts separated by transverse partitions called nodes. The outer part is the epidermis which is composed mainly by epidermal cells, cork cells, silica cells and stomata. Stomata are very important because they are used for gas exchange. Cells of the epidermis form a compact layer all around the stem. A cuticle wraps the epidermis to protect the plant against injuries and prevent the loss of moisture. The major part of the stem is built up of parenchymatous tissue with vascular bundles inside. As shown on Fig. 18.6, they are spread throughout the stem cross-section. They are often smaller and denser in the periphery area. Their role is to conduct water and food but also to give the plant rigidity. Vessels, sieve tubes, fibres, tracheids, parenchyma and sclereids compose the vascular bundle.

The flax structure is composed by epidermis, cortex (protective layer), phloem (conducting tissue), vascular cambium and secondary xylem which are water conductive tissue (cf. Fig. 18.7).

Bast fibres come from the phloem which is located between the vascular cambium and the cortex. They are generally arranged in fibre bundles each containing from 12 to 40 fibres. They give rigidity and flexibility to the stem. Secondary xylem is not only composed of parenchyma cells, but also some pitted vessels, tracheids and fibres.

The hemp structure is close to the flax structure. One important point is that the tall plant stems of hems suppress weeds and diseases and pest are rarely recorded (Bois, 1982).

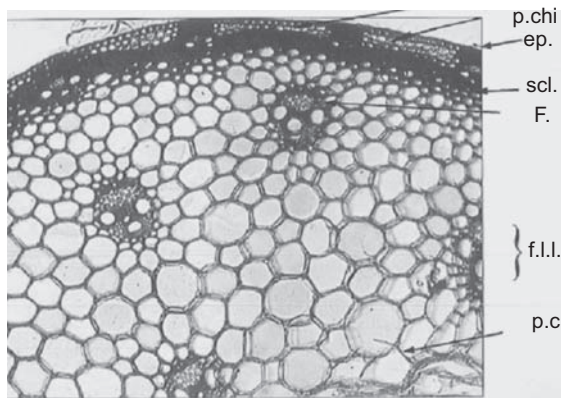

Figure 18.6 Transverse view of wheat stem; ep: epidermis, p.chl: chlorenchyma, scl: sclerenchyma, F: fibres, f.l.l.: vascular bundle, p.c.: cellulosic parenchyma (source: Aitken et al., 1998).

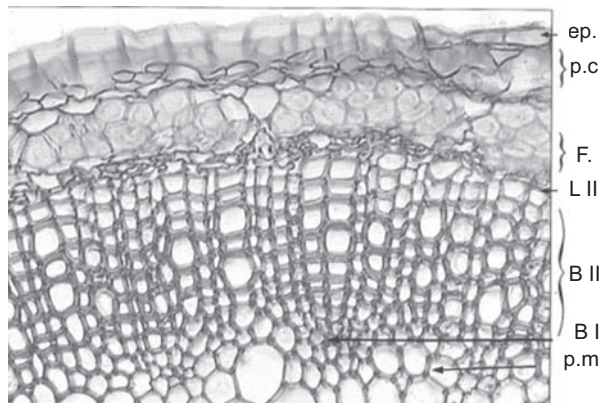

Figure 18.7 Transverse view of flax stem; ep: epidermis, p.c.: parenchyma, F: extraxylary fibres, L.II: secondary phloem, b.I: primary xylem, b.II: secondary xylem, p.m: parenchyma (source: Aitken et al., 1988).

Main bast fibres used for papermaking are hemp, flax but also kenaf and jute. These fibres are an important source of raw material for papermakers located in developing countries like Bangladesh, Philippines or Ecuador in order to reduce the importation of virgin wood pulp.

Hemp bast fibres are 15–50 mm in length and 25 μm in width. Hemp core fibres are shorter with a length of around 0.5 mm. Hemp bast fibres are commonly reported as stronger than pine fibres but due to their length, they have to be cut during the process. Hemp pulp is very easy to bleach by a hydrogen peroxide stage (TCF). Hemp papers are very resistant to the degradation and its yellowing is very low compared to wood fibres paper.

The fibre makeup of Hemp and Kenaf is significantly different in terms of bast fibres (respectively 25% and 40%) and core fibres (respectively 75% and 60%). One advantage to use kenaf fibres instead of hemp fibres are the yield of production which is the double compare to the production of hemp and the bast fibres length (2.6 mm) is roughly the same than softwood. The kenaf fibres are longer, wider and a higher length/width ratio than hemp fibres. Furthermore, Kenaf is not related to Cannabis classification which is an ethic advantage.

Jute fibres can be included in the composition of graphic papers in state of the soft-wood pulp even if more refining energy is needed to reach a given tensile strength. We have to note that the jute pulp price is higher than for the wood pulp but some researches have been perform to use the also the jute cuttings and the jute caddis (Jahan et al., 2007).

An example of grass fibres structure is given by the esparto leaf (cf. Fig. 18.8). Due to stone cells in the stem, only leaves are utilized in the pulp and paper industry. Leaves are rolled-up longitudinally in order to prevent water evaporation during hot temperature. Several kinds of cells can be found in pulp. The outer epidermis is based on cutinised and siliceous cells which look like comb (similarly to those of the wheat stem). On the upper part of the leaf, numerous stomata are included in the epidermis.

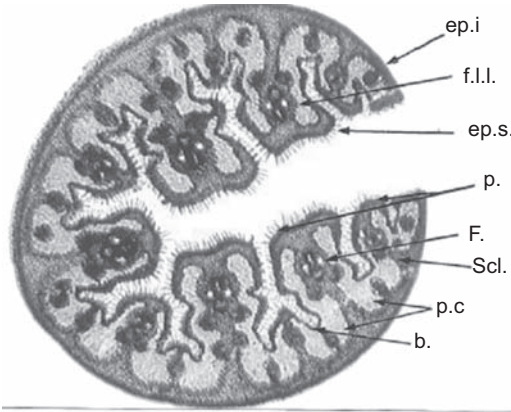

Figure 18.8 Cross section of esparto leaf; ep.i: lower epidermis, ep.s: upper epidermis, scl: sclerenchyma, p.c.: cellulosic parenchyma, f.l.l.: vascular bundle, p: “comma hairs”, b: bulliform cells (source Aitken et al., 1988).

On the lower part which is often “inside” the leaf, comma hairs and bulliform cells are visible. The role of bulliform cells is to roll-up the leaf if there is a lack of water. The main inner part is occupied by fibrous sclerenchyma which wraps the vascular bundle.

Abaca and Sisal belong to the group of leaves fibres. Fibres are much longer than esparto fibres with respectively a length of 6 and 3 mm. They are widely used for the production of speciality paper mainly for tea bag and filter papers. Sisal has a high tear resistance, high alpha cellulose content, high absorbency and high folding endurance (Hurter, 2001). They could be used to reduce the paper basic weight while maintaining their mechanical properties.

Fruit fibres are coming from the seeds (cotton), pods (kapok) or husks (coir). Only cotton is detailed here because cotton fibres are the most used. Cotton fibres are almost pure cellulose. They are seed hairs which are formed by the elongation of single epidermal cell. Generally two kinds of fibres are distinguished: lint (long fibres) and linters (shorter ones). Pulpmakers used only fibres which have not been utilized by the textile industry (textile cuttings, old rags and first or second cut linters). Cotton fibres are characterized by their smooth-looking, their ribbonlike and they are very twisted. Each fibre, especially for linters furniture, has a tapering tip and a broken base where the fibre was parted from the seed.

18.2.3 Structure and ultrastructure of fibres

Three main chemical components are present in wood (Browning, 1967; Paavilainen, 2002): cellulose (40%–48%); lignins (18%–27%); and hemicelluloses (22%–42%). Proteins and pectins are present in lower rates. Cellulose is a polysaccharide with a linear arrangement of thousands of elementary molecules of glucose. These molecules join together to build microfibrils (Frey-Wissling, 1958) and they roll themselves up to form beams. Hemicelluloses are sugar chains but they are

branched and involve different kinds of sugar. Xyloglucans are mainly in the primary cell wall and xylans are in the secondary cell wall. Hemicelluloses cover the cellulose microfibrils (Salmen and Olson, 1998) and play a role in the cohesion of these materials. Lignins and hemicelluloses glue microfibrils together (Fahlen and Salmen, 2005) and make them waterproof and create stiff cell walls. Lignins come from the polymerization of phenolic units. For example, lignins from compression wood are very condensed and so very hard (Westermarck and Samuelsson, 1986). For normal wood, the fibre wall is composed of different layers (cf. Fig. 18.9) which are produced at different periods during cell differentiation. The cellulose, hemicelluloses and lignins deposition in the fibre layers and the deposition kinetics are complex. Hosoo et al. (2003) expects that the deposition follows a daily cycle controlled by the light. During the illumination, microfibrils are built and during the night hemicelluloses and lignins which form the matrix will be accumulated. Middle lamella (ML) is the first layer developed after cell division. It is located between the wood cell to ensure the adhesion between 1 cell and the next. The thickness of this layer ranges between 0.5 and 1.5 μm . It is made up of pectic substances to which lignins may be added during the differentiation time. The primary wall (P) is produced at the beginning of cell differentiation. This elastic layer is attached to the middle lamella. Its thickness is approximately 0.1 μm . It is composed of several layers of microfibrils which are arranged randomly within this wall. Between these microfibrils, it is possible to find lignins, hemicellulose and peptides. The secondary wall, composed of S1, S2 and S3, is the most important layer for the cell in terms of mechanical properties (Timell, 1986). It is formed inside the P wall before the cell reaches its definitive size. The S1 layer is only 0.1–0.35 μm thick and represents only 5%–10% of the total thickness of the cell wall. It is generally considered as an intermediate layer between the primary cell wall and the S2 layer. Microfibrils angle range between 60 and 80 degrees with regard to the cell axis. The S2 layer is the most important layer

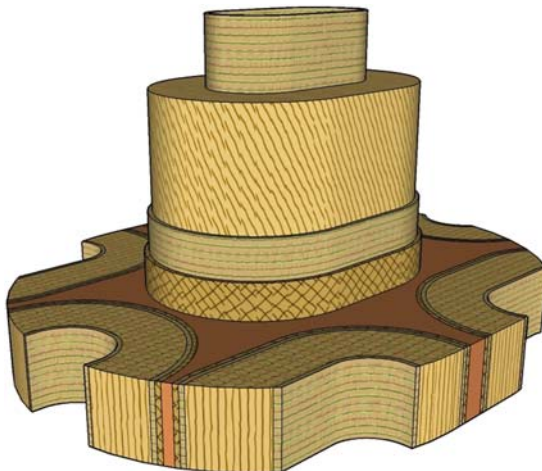

Figure 18.9 Fibre ultra-structure (source: Ali, 2006).

from a mechanical properties point of view. Its thickness varies between 1 and 10 μm and so represents 75%–85% of the cell wall thickness. The microfibrils angle is 5–30 degrees to the cell axis. High values correspond to early wood. As the microfibrils angle increases with regard to the cell axis, wood becomes less rigid and the longitudinal modulus of elasticity decreases (as for juvenile wood or compression wood). The S3 layer is the inner layer of the secondary wall and has a thickness of between 0.5 and 1.10 μm . In this layer, microfibrils have a parallel arrangement with an angle of 60–90 degrees with regard to the cell axis.

18.3 Pulping and papermaking processes

In this part, basic knowledge is given on wood pulp preparation and also on the papermaking process (Valette and De Choudens, 1992; Smook, 1992).

18.3.1 Pulping

The aim of the pulping processes is to separate fibres and other cells from each other. Wood arrives at the mill in several forms: roundwood, sapwood or wood chips from a sawmill. The first step for roundwood raw material is the debarking. Bark is not utilized in the pulp process because it carries a lot of undesirable elements like metal ions which reduce the pulp yield and increase corrosion, and sand which has an erosion effect on pipes and valves. Two main possibilities exist in order to achieve defibering: either by mechanical action which leads to mechanical pulp, or by chemical action to produce chemical pulps. There is also hybrid defibering combining mechanical and chemical actions such as chemical thermo mechanical pulp (CTMP). Currently, chemical pulping represents 75% of the world pulp production.

18.3.1.1 Mechanical pulping

The principle of mechanical pulping is to grind or to grate logs or chips. Mechanical pulping leads to high yield of pulp generally almost 95%. The obtained pulps contain fibres which are more or less damaged, fines which are pieces of the cell wall and also shives which corresponds to a small piece of wood (two or more still glued together). Damages affecting the fibre include the cutting effect but also fibrillation of the cell wall (Petit-Conil et al., 1999). Stone groundwood processes, like stone groundwood pulp (SGW), pressurized groundwood pulp (PGW) and thermo groundwood pulp (TGW), are based on the grinding of logs against an abrasive stone. It must be sharpened periodically. Pressure applied and the water temperature for the shower are the main parameters to be controlled in this process. Another solution to produce mechanical pulp is to introduce chips or sawdust between two refiner discs which are very close. Damages which occur in this operation, lead to separate fibres from each other. Concerning refining pulps, like refiner mechanical pulp (RMP), thermo mechanical pulp (TMP) and refining thermo-mechanical pulp at high speed of refining (RTS), main process parameters are rotation speed, pressure, presence of

preheating and the geometry of the refiner discs. chemico-thermo mechanical pulp (CTMP) combines mechanical and chemical actions. Before refining, chips are pre-impregnated generally with sodium sulphite. Depending on the mechanical processes, fibre separations occur in different areas which are located more or less near the medium lamella for CTMP, in P, S1 and S2 for TMP and everywhere for RMP (cf. Fig. 18.10). Table 18.3 summarises the main characteristics of mechanical pulps and Fig. 18.11 shows an example of the morphology of components of an RMP pulp.

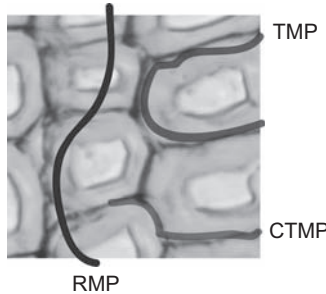

Figure 18.10 Fracture lines in wood during mechanical pulping.

Table 18.3 Main characteristics for mechanical pulps.

Process	SGW	RMP	CTMP
Breaking length (m)	3000	3600	4800
Tear index (mN.m ² .g ⁻¹)	3.5	6.5	9.0
Somerville index ^a (%)	1.6	1.2	0.2
R30 fiberres ^b (%)	15	25	42

Draining index: 100 CSF; Wood specie: fir; SGW: stone groundwood pulp; RMP: refining pulp; CTMP: chemical thermo mechanical pulp.

^aSomerville index represents the content of shive in the pulp.

^bR30 fiberres: fibers which are retains on a 30 mesh screen in the Bauer MacNett screener.

From Vallette, P., De Choudens, C., 1992, Le bois, la pâte, le papier, Grenoble, CTP.

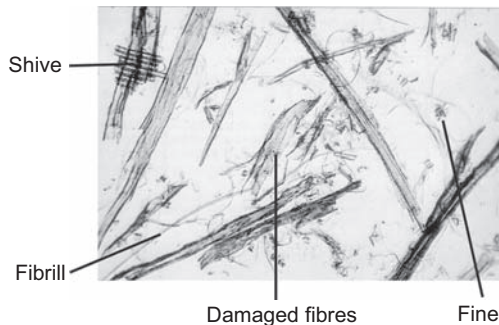

Figure 18.11 Refining mechanical pulp.

18.3.1.2 Chemical pulping

The aim of chemicals using is to degrade and dissolve the lignins without affecting the hemicellulose and cellulose chains. During cooking, wood chips are treated in cooking liquor at a high temperature. Yields are lower than for mechanical pulps due to the material removal. They range between 45% and 55% depending on the required delignification. Two different chemical processes are generally distinguished: alkaline and acid cooking. Currently, about 90% of the commercial pulp is produced with the alkaline process. Kraft (or alkaline) cooking is based on the use of a mixture of sodium hydroxide (NaOH) and sodium sulphite (Na_2S). Treatment duration is around 2–5 h at 160–175°C depending on the wood species and the desired delignification rate. Kraft pulps have very good mechanical properties but they have a dark brown colour. Contrary to kraft cooking, the sulphite process induces lignin sulphonation with a yield of about 50%. The active molecule is free or combined SO_2 . Cooking conditions include a temperature between 120 and 150°C for 8–12 h with a liquid over wood ratio of 4–5. As seen in Table 18.4, mechanical characteristics for the sulphite pulp are lower than for the kraft pulp. Nevertheless, these pulps have a good brightness and are easily bleached. Fig. 18.12 shows the morphology of Kraft and bisulfite pulps. More flexible and ribbonlike fibres are present in the bisulfite pulp (coloured in magenta with the Lofton-Merritt stain) whereas Kraft pulp fibres are more kinked (coloured in blue with the Lofton-Merritt stain).

18.3.1.3 Bleaching

The aim of bleaching is to increase the brightness by removing or modifying the coloured molecules which are produced during the cooking. Mechanical and chemical pulps are not bleached in the same way due to a different chemical composition. Bleaching of mechanical pulps is generally done by oxidation (for example hydrogen peroxide) or reduction (for example sodium hydrosulfite) of the chromophores present in the pulp and leads respectively to a brightness of 80% and 70% ISO. Note that in this case, lignins are not removed but only decoloured. In the case of chemical pulp

Table 18.4 Physical properties of kraft and bisulfite pulps.

Process	Kraft	Kraft	Bisulfite
	Seaside pine	beech	Seaside pine
Breaking length (m)	8900	7500	6500
Burst index ($\text{kPa}\cdot\text{m}^2\cdot\text{g}^{-1}$)	5.8	4.5	4.0
Tear index ($\text{mN}\cdot\text{m}^2\cdot\text{g}^{-1}$)	12	8	7.5
Brightness (%ISO)	28	29	60

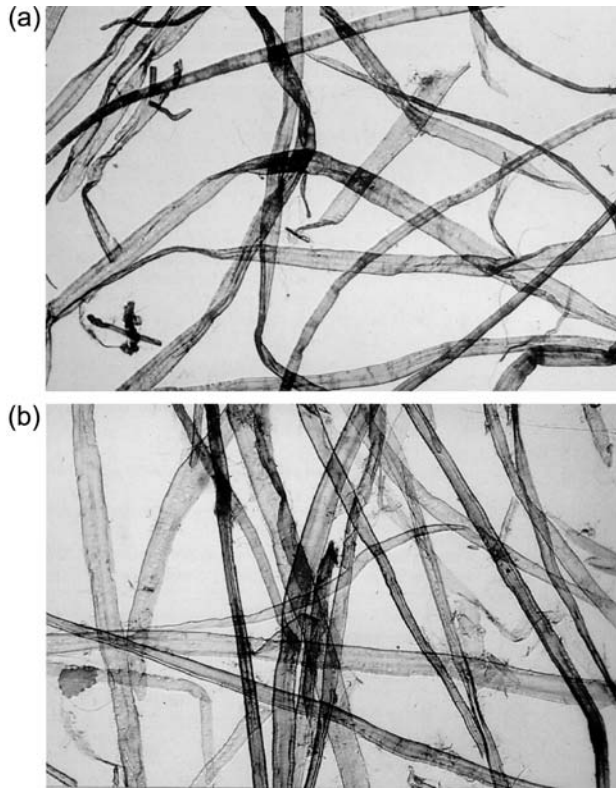

Figure 18.12 Chemical pulps. (a) Bisulphite pulp; (b) Kraft pulp.

bleaching, residual lignins are removed. Processes are much more complex and several steps have to be combined. Brightness over 90% can be achieved by a CEDED sequence (C = chlorine stage, E = alkaline extraction, D = chlorine dioxide stage). The lack of lignin in the fibre structure is visible in optical microscopy by observing the uncoloured fibres after Lofton-Merritt staining. Traditionally, bleaching sequences use Cl_2 or NaOCl chemicals. The problem is the emission of organo-chloride compounds which are not good for the environment. New sequences have been developed like ECF (Elementary Chloride Free) or TCF (totally chlorine free) sequences. ECF produces five times fewer organo-chlorine compounds but it is expensive. Chemicals employed are O_2 , ClO_2 , H_2O_2 and O_3 . In TCF, only O_2 , H_2O_2 or O_3 are used. It is like green bleaching and furthermore the effluent may be incinerated. Physical properties of pulps bleached with an ozone stage are often discussed in the literature. It seems that a well controlled Z-stage doesn't affect too much the pulp characteristics. Some are increased like the brightness stability (Mishra, 2010). Recovered fibres can also be bleached but not necessary depending on wanted paper grade. The acronym PCF (Process Chlorine Free) indicates that the fibres has been recycled and after recycling either no additional bleaching was performed or the re-bleaching was performed without the use of any chlorine derivatives.

18.3.1.4 Steam explosion

Steam explosion is a simple technique to separate fibres or fibres bundles. The biomass is treated with saturated pressure up to 40 bars during a certain time, between several seconds to some minutes. Then, a very fast decompression stage occurs to 1 bar.

The process is often quantified by the severity parameter and it ranges generally between 2 and 6.

The severity is the equal to the $\log_{10}(R_0)$ where the reaction ordinate R_0 allows the optimization of the steam process and the possibility to reach equivalent products for various temperature/retention time couples with a base temperature of 100°C and an activation energy of 14.75.

$$R_0 = t \cdot \exp\left(\frac{T - 100}{14.75}\right)$$

In this equation, t is the residence time and T the reaction temperature.

[Karr et al. \(1998\)](#) explain that this reaction ordinate depends of the raw materials (nature and size) and this parameter is not suitable when chemicals are added. Also, a combined severity (CS) has been proposed which take into account the pH.

The steam explosion could be processed either in a batch or in a continuous ways and a law is existing to compare the two modes through the reaction ordinate.

$$\log R_{0 \text{ batch}} = 1.5 (\log R_{0 \text{ continuous}} - 1)$$

From a morphological point of view, fibres are extensively fibrillated during the treatment due to the adiabatic expansion of absorbed water. Furthermore, the treatment has an impact on the cellulose through the degradation of amorphous cellulose and the increase of its crystallinity.

A good summary about steam explosion pretreatment for producing sugars and ethanol is available in the review from [Wang et al. \(2014\)](#).

18.3.1.5 Production of MFC and NCC

The production of microfibrils of cellulose (MFC) corresponds to a deconstruction of the fibre cell wall material. It will be a unique renewable building block to improve or to develop new functionalities of materials. After the removal of all the lignins and the hemicelluloses, bleached fibres are refined at a high level with conventional refiners. Then, they are introduced in devices like Massuko or micro-fluidizer which applied high shear stress respectively by mechanical treatment with nonporous specific grinder discs and by passing the suspension in an interaction chamber. Its geometry could have several forms but contains always a high shear area and a high impact zone. Shear rates are generally over 500,000 s⁻¹ and can reach 10,000,000 s⁻¹. Another way of production is to use of ultrasounds to assist the fibrillation. The range size of obtained fibrillated material is at micrometre scale for the length and between 10 and 100 nm.

To obtain cellulose nanocrystals (NCC), MFC are chemically treated to remove the amorphous parts of cellulose chains by hydrolysis either with H_2SO_4 (65wt%) or HCl (2.5–4 N) under reflux. Then a purification step occurs by dialysis or centrifugation before a sonification stage.

The key point limiting the development of the industrial production of MFC and NCC is the price due to the high energy consumption. The energetic consumption is about 100 MWh/t for the production of NFC. Those values are about 1000 times more than classical values of specific energy (100–200 kWh/t) used during the refining stage of the paper production. The amount of energy was in the range of 5000–80,000 kJ/kg (Spence et al., 2011).

In order to reduce the energy consumption of the production stage, some pre-treatments are applied like alkaline one, TEMPO oxidation ((2,2,6,6-Tetramethyl-piperidin-1-oxyl)/NaBr/NaOCl, during 2 h) (Khiari et al., 2019), carboxy-methylation or enzymatic treatment (50°C, pH = 5, 1 h) which can save around 60% of the electrical energy (Liu et al., 2019).

Enzymatic (endoglucanase) or chemical (tempo) pre-treatments can be performed to reduce the amount of required energy to 1–2 MWh/t. The energy need is depending on the carboxyl content and Tejado et al. (2012) obtain a spontaneous disintegration with the use of 3 mmol/g. Chaker et al. (2014) show that the difference in the fibrillation efficiency and energy consumption was explained by the hemicellulose content and the DP of the oxidised fibres. The higher content in the hemicellulose and lower DP contributed to reducing the extent of the microfibril aggregation by hydrogen bonding and to loosening their cohesion of the elementary microfibrils within the cell wall, making their detachment under the action of mechanical shearing easier (Dufresne, 2018). Combining enzymatic treatment with a twin-screw extruder allows producing good quality NFC (Rol, 2018).

Alila et al. (2013) have compared different non-woody plants as raw materials for production of NFC and show that leaves fibres (abaca, sisal) lead to thinner and less long fibrils than those extracted from hemp or jute fibres.

Leaders companies for CNFs are based in Japan with Nippon Paper (450 ton/y) and Oji Holdings but also some facilities have been established in Europe (Borregaard in Norway, Innventia in Sweden), Canada and the United States (American Process Inc.). A good review of the actors in this field was presented at the TAPPI Nano conference in Grenoble (TAPPI, 2015).

18.3.2 Papermaking

The know-how of papermakers helps them to choose the right raw material and to properly arrange the fibres in the web in order to produce papers with special end-use characteristics. The papermaking process may be divided into four parts: stock preparation, sheet formation, pressing and drying, and sizing and coating (if necessary).

18.3.2.1 Stock preparation

Stock preparation can be simplified according to Fig. 18.13. Papermakers who are not pulp producers receive dry pulp on the form of very thick sheets (pulp bales) without any treatments or additives. The dry pulps are first disintegrated in a pulper equipped with a turbine to disperse each fibre from the other at a consistency of 6%–7% for virgin pulp and from 12% to 18% for recovered fibres. Deflaking is the second step in order to obtain a very good disintegration. This is mandatory if recovered papers are used. The refining stage is a very important operation. This is done to modify the fibre cell wall structure. Fibres are forced to go between two discs which have a special design. Due to pressure pulsations, three effects occur at the fibre level: hydration, cutting and fibrillation (cf. Fig. 18.14). A lot of work has been conducted on this topic to reduce energy consumption and to understand the refining effect on fibre (Backer, 2000; Jorris, 1986; Kerekes, 1990; Roux et al., 2007). Hydration is the penetration of water into the fibre by the fibre wall porosity (pits, cracks, delamination etc.). This causes an increase of the fibre width and of the flexibility. Fibre conformability is also better, so that means the amount of contact between fibres increases in the paper sheet. With the sharp mechanical actions, the fibre cell wall is damaged and fibrillation occurs. Fibrillation looks like hairs at the fibre surface. This phenomenon is very important because it increases the specific area and the ability for fibres to bond to each other's. The cutting effect occurs each time the mechanical impact on the fibre is too high. Sometimes it is desirable, but most of the time it is not wanted. The cutting effect reduces fibre length so obtained pulps are generally less flocculated. Special disc geometry allows favouring one of these effects but it is currently not possible to obtain only one of them. Pulp screening is generally a part of what papermakers call the “approach system” of the paper machine. The aim is to remove heavy or light contaminants either by the use of centrifugal force or by the use of baskets with holes or slots. Some rejects come out of the

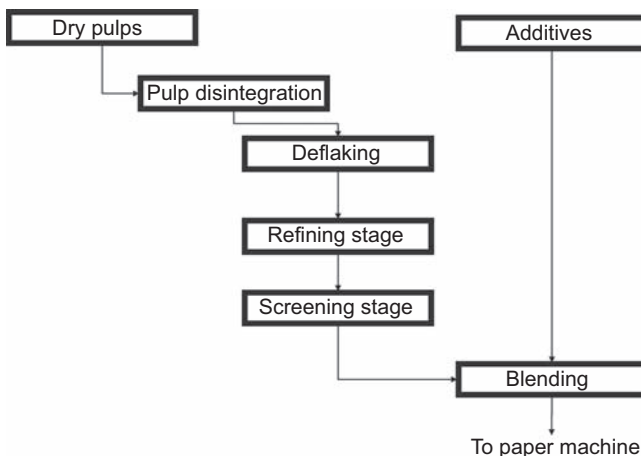

Figure 18.13 Schematic view of an approach flow system of a paper machine.

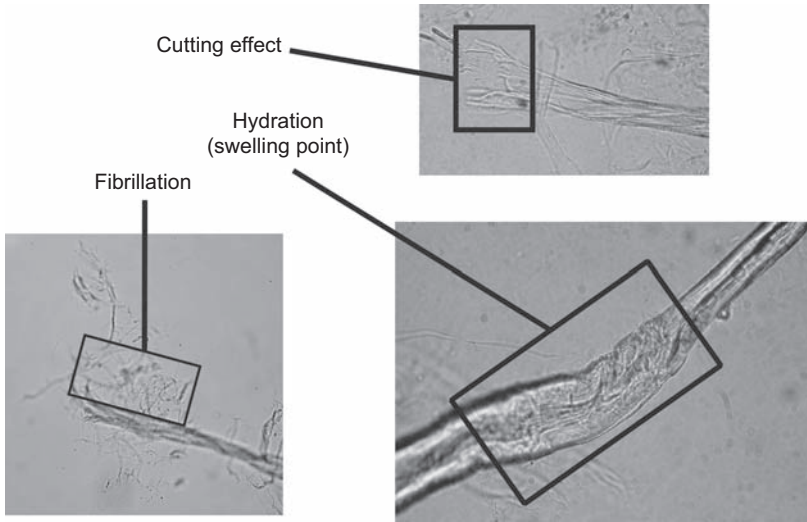

Figure 18.14 Refining effects on fibre morphology.

process in this stage essentially as contaminants and very short pieces of fibre. The last step before sending the pulp to the paper machine is to blend the different raw materials (fibrous or not). To optimise price and paper end-use characteristics, it is necessary to use different kinds of fibre which have had specific treatment (refining for example). Softwood chemical fibres (generally refined) give mechanical characteristics; hardwood chemical fibres are good for printability. But also, fillers may be added to improve the brightness, to improve the opacity, or to reduce the production costs. Most common fillers are calcium carbonate, talc, kaolin and titanium dioxide. Furthermore, other chemical additives are mixed in the pulp in order to aid the paper production like retention aids, dewatering aids or to control the proliferation of bio-organisms.

18.3.2.2 Sheet formation

Sheet formation depends on the stock preparation but also, and above all, the pulp repartition at the wire surface and the ability to remove water. The headbox is the part which allows diluted pulp defloculation and the spreading out of the pulp at the wire surface. It plays a major roll in the control of the basic weight of the paper sheet which has to be the same all along the cross-direction (headboxes are sectionalized for a better control of the pressure or of the dilution rate). Fibre orientation is an important parameter which explains the anisotropy in the sheet. It is possible to control it by the adjustment of the wire speed and the pulp jet velocity. After the pulp has been deposited on the wire, a lot of water must be removed because the process consistency is around 0.1%–1.5% in the headbox. The most economical ways are applied by using depressions under the wire (rolls in rotation, foils, vacuum boxes, and couch rolls). By this operation, some fine particles (fines) and fillers

can go through the wire instead of being retained or bonded at the fibre surface. In order to reduce paper dissymmetry in the cross-section and to increase paper production, double wires and top forming have been developed. At the end of the sheet formation block, the sheet humidity is around 80%.

18.3.2.3 Pressing and drying sections

Sheet pressing ability is a function of the compression resistance and of the filtration resistance of the wet sheet. Pressing consists of removing water from the sheet when it goes between two rolls (plain rolls or suction rolls) which are pressed together. The application of pressure (amount of pressure and duration of pressing) results in various paper characteristics due to different fibre-fibre bond development. After the pressing section, the paper sheet humidity is about 35%–45%. In the drying section, the aim is to remove water until reaching a paper sheet humidity of 4%. The wet paper sheet is heated to evaporate the water either by conduction or by convection or by infrared radiation depending upon the paper grade. During this stage, hydrogen bonds between fibres are created because fibres become very close to each other.

18.3.2.4 Sizing – coating – calendering

In most cases, paper surface is not appropriated to the end-use characteristics required by customers. Sizing and coating are operations which change the physico-chemical characteristics and/or porosity of the surface properties by deposition of starch or of one or several layers of pigments (e.g.: latex and mineral fillers). Calendering allows developing specific surface characteristics like the increase of gloss and the decrease of smoothness. A calendar consists of a set of horizontal cylindrical rolls, vertically stacked one upon the other, through which the paper sheet is passed. Pressure applied on each roll, roll temperature, number of rolls and the nature of the roll surface are the main factors influencing the surface modification. Sizing, coating and calendering may be done on-line or not. At the end of the paper machine, paper is rolled during the winding operation to produce drums up to 30–40 tons which are then cut down into several smaller rolls according to the right length and width required by customers.

18.3.3 Specificities of non-wood fibres for pulp and papermaking

Since the 90', non-wood fibres have had a renewed of interest due to the gradually rising costs of wood and the disposal of more and more agricultural residues (Sabharwal and Young, 1996). Alternative fibres could contribute to reduce the pressure to harvest trees for papermaking or to use sub-product of food industry. Furthermore, some of them have environmental advantages as for bamboo. In the paper industry, non-wood fibres are divided in three groups depending on their origin: agriculture residues, natural growing plants and non-wood crops. As for China, the use of non-wood fibres is a necessity due to the shortage of wood resources in comparison

with the expected board and paper production. About 85% of non-wood papers are made in China (Kinsella et al., 2007). The choice to use one species of non-wood plant is depending on the raw material availability but also on the local market. Straw materials are by far the largest source of non-wood fibres, followed by bagasse and bamboo. Some examples of the used of non-wood fibre in paper are mentioned by Atchison (1996). Agricultural residues are locally available either at low cost or for free. Labour costs contribute for a large part of the total raw material price because they are manually collected. Their harvests are realized during a short period of time and then they are stored the rest of the year. Special precautions have to be taken in order to avoid deterioration of the raw material. Due to the bulk of this kind of material, it is necessary to have large storage areas. All non-fibrous components need to be removed from the raw material and the remaining fibres must be cleaned of dirt, rocks and other contaminants.

Generally, pulping non-wood plants is cheaper than pulping wood due to their lower lignin content (for example, bagasse and straw will cook within 10–15 min according to Hunt (2002)). Different cooking processes (about 40) including Alcell process (Winner, 1991) have been considered depending on the desired pulp quality and on the used non-wood plant (cf. Table 18.5). Zhou (2012) proposes a separate pulping of the hemp skin and the stem. Ultrasonic treatment of hemp is a way to produce hemp pulp and Zule et al. (2012) report that the paper characteristics are similar or even better than usual papermaking fibres from woods. A good review of different kinds of pulping of non-wood fibres (wheat, kenaf, bamboo and bagasse) is given by Liu (2018).

But this good point is thwarted by the bad washing ability (the high viscosity of the black liquor, due to the pentosan level, requires larger washing equipments) and by the difficulties for chemical recovery. Furthermore more water is necessary during the washing stage and this increase the load on the evaporator. During cooking of non-wood fibres, silicon compounds, coming from the raw material, are largely transformed into soluble silicates which transfer to the black liquor and cause major problems in the recovery circuit (Delmas et al., 2003): low heat transfer rates in the

Table 18.5 Smart packaging under development.

Active	Intelligent
Oxygen scavenging	Time-temperature history
Anti-microbial	Microbial growth indicators
Ethylene scavenging	Light protection (photochromic)
Heating/cooling	Physical shock indicators
Odour and flavour absorbing/releasing	Leakage, microbial spoilage indicating
Moisture absorbing	

evaporators, low maximum attainable black liquor firing concentration, scaling and fouling of the evaporators, plugging of boiler tubes (Saroha et al., 2003). Some treatments are under investigations (Tutus, 2003) like the Lignin Precipitation System, Wet Oxidation (Granit S.A.), fluidized bed technology (AF-QPS) or Conox (Myreen, 1998). Another solution is to use nonfouling electrolytic membrane technology (Electrosep Inc.). Depithing is also a critical point for some raw materials like bagasse to avoid washing problem and the clog of paper machine wires. The easy process seems to be a very powerful one. It is a combination of a mild extraction followed by acidification, ozone treatment and then ECF or TCF bleaching.

Bleaching non-wood fibres is easier compared to wood fibre. For example, hemp fibres can be bleached with relatively harmless hydrogen peroxide. For hemp and flax, TCF sequence give a good bleached pulp by using EDTA as metals controller, TAED as a peroxide activator and ultrasound (Snell, 2002). Miao et al. (2014) give cooking and OD₁ED₂ bleaching conditions to obtain hemp pulp with a high viscosity (893 mL g⁻¹) and an ISO-brightness over 85%.

Like hemp or ramie, some non-wood fibres are very long, and they are unable to give a homogeneous paper sheet. They must be cut in order to obtain fibre fragment with a length at around two to 3 millimetres. Refining stage is also realized with less refining energy to achieve the same freeness drop as in wood pulp. The bad drainability of non-wood fibres pulp has the consequence to reduce the paper machine production.

As a conclusion, it is possible to mention three axes of major importance. Firstly, it is necessary to install recovery system (to recover inorganic chemicals) in order to prevent environmental injuries. But this demands a lot of money and as non-wood users are generally small papermakers, they have not enough money to install them. The second point is that present pulping technology has been optimised for tree-fibre pulping. Some adjustments have to be made to optimize conventional processes for this kind of raw materials. Thirdly, from an ecological footprint, wheat straw and flax straw seem to reduce harvest pressure on forested lands. Using the wheat straw available from just 0.6 ha of agricultural land would relieve the equivalent of 5.5 ha of spruce or 2.3 ha of aspen forest (Kissinger et al., 2007). According to Hurter (2007), there is only one serious threat to non-wood fibre raw materials for pulp and papermaking and it can be summed up by the “Bio-Mania” which is the huge and growing interest in generating electricity and producing fuels from biomass.

18.4 New challenges for paper and board producers

Pulp and papermakers have to meet the future challenges which are mainly the good nutrition of an increasing population and the global warming. So, they have to better use the natural resources like agricultural wastes and woods. Also they have to adapt their process to the future available resources and to the new technological products demands.

According to [Mac Dicken \(2015\)](#), understanding the global forest resource changes is more complicated than one might think.

18.4.1 Damaged wood

One of the effects of the global warming and so of the climate change is the increase of the number of extreme weather events like storms. During storms a big amount of trees is partially destroyed given windfall wood. The amount of windfall is so important that logging industry, in which pulp producers participate, are not able to absorb quickly these wood resources. Woods have to be stored properly to avoid chemical and bacterial degradations by means of continuous water spraying or by storage in vessel containing a very low level of oxygen. Nevertheless, still remain the problem of the delay to remove the damaged timbers from the forest.

Due to the natural degradation, the chemical composition of wood is changing which induced a reduction of the pulp production yield, the decrease of the polymerisation degree of the cellulose and finally lower pulp mechanical characteristics. From a process point of view, the industrial cooking conditions have to be adapted and according to some companies, the amount of windfall in the wood entrance should be limited to about 20%.

Two others kind of damaged wood have to be studied for pulp production namely fire wood and insect infected wood. The literature is very poor in the area...

18.4.2 Invasive plants

In agreement with the global warming, the temperature increase, +2.5°C since the end of the century, and the amount and flow of the water rain will drastically change. Also, due to international trading and tourism, the possibility to accidentally transport some plant seeds or pollen grains are important.

Both aspects are leading that species which are not native to an area, can growth because they find good environmental conditions in term of humidity, temperature and soil contains. Their growth is generally very fast because they have no limitations (pests, herbivores or diseases).

Some articles are dealing with the opportunity to introduce them in pulp and try to evaluate their papermaking potential as for example the *Ailanthus Altissima* ([Ferriera et al., 2013](#)). The authors show that this specie has a lower amount of lignin, a higher brightness than *Eucalyptus Globulus* and could be mixed until 50% with eucalyptus pulp without losing mechanical properties. These invasive plants are also an opportunity to avoid being dependent on *Eucalyptus* forestry.

18.4.3 Smart functions

NFCs have gained considerable attention due to their potential applications such as strength additives for paper, barrier packaging, adsorbent products and drug carriers. A recent review from [Boufi \(2016\)](#) details how could be use the NFC in pulp and paper. Use of MFC with a ratio of 40 mg/g can improve the tensile index and the

internal cohesion of paper respectively of 5% and 50%. Consequence of using this MFC is the reduction of the drainage on the paper machine which implies either an increasing of the vacuum under the forming wire or a reduction of the speed of production. Also, using a mixture between MFC and mineral fillers improve the retention on the wire.

Nevertheless, by using MFC grafting (e.g. AKD grafting), papers with good barrier property against water were obtained. A lot of studies show the reduction of the air permeability of paper mainly explained by the reduction of the material porosity. MFC layers can be deposit by spray or by bar coating techniques.

Yungchang F. Chin and Yan Feng published in 2014 the patent US 20140050922 A1 for coating and coated paper. They obtained an improve of the fracture resistance of the paper, reduce the risk of heavy coat cracking and mechanical failure of the coat such as spallation, blistering, tearing, and peeling away from the paper substrate.

During the last 10 years, others developments occur through the use of the 3D architectural aspect of paper. One way is to use the fibres arrangement to control the fluidic path: these open the medicinal field. One can think about cheap blood tests or patch with medical releasing.

The second way is to introduce electrical functions. The printing electronic is now well known but some studies are dealing with the introduction of electronic functions in the bulk of the paper. RFID antennae are introduced between two layers of papers which reduce drastically the cost of intelligent stickers. Also, one can envisage depositing conductive polymer at a specific location during the paper production to produce capacitors.

The use of conductive particles (black carbon particles, graphene) allow the paper to become a good conductor and some flexible detector or actuator could be imagined.

18.5 Conclusions and futures trends

Board and Paper production is globally increasing in the world due to global population expansion and their needs of goods consumption. The market of some grades tends to decrease like graphic papers but some others opportunities will arrive especially in the packaging and speciality papers (super-hydrophobic papers, conductive papers). The developments concern the fibres functionalization, but also the production of new boards and papers with a controlled pattern at the surface but also in the bulk of the material where some materials could be added like RFID antenna or natural fibres with low mechanical characteristics.

To answer to the environmental requirements, paper industry has to reduce more and more its carbon footprint by decreasing its energy consumption, reducing their atmospheric and water rejects but also by taking into accounts the carbon emissions due to the transport of the raw materials and the end-products. For this second point the reduction of the paper basic weight by maintaining the physical characteristics is challenging and adding kenaf or hemp fibres could be a solution.

In a lot of countries, the availability of non-wood plants is a reality but more researches have to be performed to replace wood fibres by these raw materials. Cost pulp reduction, pulp quality and process optimization are the main axis to work on.

Furthermore, due to the Earth warming, plants and wood species will change: more invasive species, worth wood quality due to insect's attacks or storms. The pulp and paper industry has a major role to play for the planet protection by using the fibres coming from these resources. Agro-residues have also to be considered to reduce the impact of the agriculture. So, all kind of natural fibres, not only wood fibres, are of interest. Their utilisation will be more and more important and the pulp and paper industry has to prepare to manage those non-wood fibres.

Another important point is the bioraffinery concept. According to [Axegård \(2005\)](#) bio-refinery is the full utilization of the incoming biomass and other raw materials, including energy, for simultaneous production of fibres for paper products, chemicals by extracting hemi-cellulose and/or lignin ([Chirat et al., 2009b](#)) and energy like the production of bio-ethanol by fermentation ([Chirat et al., 2009a](#)).

Acknowledgements

LGP2 is part of the LabEx Tec 21 (Investissements d'Avenir - grant agreement n° ANR-11-LABX-0030) and of PolyNat Carnot Institute (Investissements d'Avenir - grant agreement n° ANR-16-CARN-0025-01).

This research was made possible thanks to the facilities of the TekLiCell platform funded by the Région Rhône-Alpes (ERDF: European regional development fund).

References

- Alila, S., Besbes, I., Rei Vilar, M., Mutjé, P., Boufi, S., 2013. Non-woody plants as raw materials for production of microfibrillated cellulose (MFC): a comparative study. *Ind. Crops Prod.* 41, 250–259.
- Atchison, J.E., 1988. Update on Global Use of Non – Wood Plant Fibres and Some Prospect for Their Greater Use in the United States. TAPPI North American Non – Wood Fibre Symposium Proceedings, pp. 13–42.
- Atchison, J.E., 1996. Twenty-five years of global progress in non-wood fibre repulping. *TAPPI* 79 (10), 87–95.
- Axegård, P., 2005. The future pulp mill – a biorefinery? In: Washington, D.C., 1st International Biorefinery Workshop.
- Backer, C., 2000. *Refining Technology*, Leatherhead. PIRA international Ltd.
- Beck, C.B., 2005. *An Introduction to Plant Structure and Development*. Cambridge University Press, New York.
- Bois, W.F., 1982. Hemp as a raw material for the paper industry. *Bedrijfsontwikkeling* 13, 851–856.
- Boufi, S., González, I., Delgado-Aguilar, M., Tarrès, Q., Àngels Pèlach, M., Mutjé, P., 2016. Nanofibrillated cellulose as an additive in papermaking process: a review. *Carbohydr. Polym.* 154, 151–166.

- Browning, B.L., 1967. *Methods of Wood Chemistry*, vol. 1. Interscience Publishers, New York.
- Butler, P., 2001. Smart packaging goes back to nature. *Materials World* 9 (3), 11–13.
- CEPI, 2018. Key Statistics 2017. Available at: <http://www.cepi.org/keystatistics2017>.
- Chaker, A., Mutje, P., Rei Vilar, M., Boufi, S., 2014. Agriculture crop residues as a source for the production of nanofibrillated cellulose with low energy demand. *Cellulose* 21, 4247–4259.
- Chirat, C., Pipon, G., Viardin, M.T., Lachenal, D., Lloyd, J.A., Suckling, I., 2009a. Hemicelluloses Extraction from eucalyptus and Softwood Chips: Pulp Properties and Ethanol Production. ISWFPC, Oslo.
- Chirat, C., Lachenal, D., Dufresne, A., 2009b. Biorefineries in a Kraft Pulp Mill: From Bio-Ethanol to Cellulose Nanocrystals. Second Nordic Wood Biorefinery Conference, Helsinki.
- Core, H.A., Côté, W.A., Day, A.C., 1979. *Wood: Structure and Identification*, seventh ed. Syracuse University Press, New York.
- Delmas, M., Quoc Lam, H., Le Bigot, Y., Avignon, G., 2003. A new non-wood pulping process for high silicon content raw materials. Application to rice straw. *Appita J.* 56 (2), 102–106.
- Dufresne, A., 2018. *Nanocellulose: From Nature to High Performance Tailored Materials*, second ed. Walter de Gruyter, p. 633p.
- Fahlen, J., Salmen, L., 2005. Ultrastructure changes in a holocellulose pulp revealed by enzymes, thermoporosimetry and atomic force microscopy. *Holzforschung* 59 (6), 589–597.
- Fengel, D., Wegener, G., 1984. *Wood: Chemistry, Ultrastructure, Reactions*. W. de Gruyter, Berlin – New York.
- Ferreira, P.J., Gamelas, J.A., Carvalho, M.G., Duarte, G., Canhoto, J., Passas, R., 2013. Evaluation of the papermaking potential of *Ailanthus Altissima*. *Ind. Crops Prod.* 42, 538–542. March.
- Frey-Wissling, A., 1958. The general structure of fibres. In: Bolam, F. (Ed.), *Fundamentals of Papermaking Fibres*, Technical Section of the British Paper and Board Maker's Association Inc, pp. 1–4.
- Helwig, T., Jannasch, R., Samson, R., DeMaio, A., Caumartin, D., 2002. 'Agricultural Biomass Residue Inventories and Conversion Systems for Energy Production in Eastern Canada', Final Report. Prepared for Natural Resources-Canada.
- Hosoo, Y., Yoshida, M., Imai, T., Okuyama, T., 2003. Diurnal differences in the innermost surface of the S2 Layer in differentiating tracheids of *Cryptomeria japonica* corresponding to a light-dark cycle. *Holzforschung* 57 (6), 567–573.
- Hunt, N.A., October 2002. The Challenges and Rewards of Bagasse Papermaking. Pira Conference, Durban, South Africa, pp. 8–11.
- Hurter, R., 2001. *Sisal Fibre: Market Opportunities in the Pulp and Paper Industry*. FAO. <http://www.fao.org/3/Y1873E/y1873e09.htm>.
- Hurter, R.W., 2007. 'Non-Wood Fibre – 2010 and Beyond: Prospects for Non-Wood Paper Production in Asia Pacific', 61st Appita Annual Conference. Gold Coast, Australia, 7-10th of May.
- Ilvessalo-Pfäffli, M.J., 1995. *Fiber Atlas: Identification of Papermaking Fibers*. Springer-Verlag, Berlin Heidelberg.
- Isenberg, I.H., 1963. The structure of wood. In: Browning, B.L. (Ed.), *The Chemistry of Wood*. Interscience Publishers, New York, pp. 7–56.
- Isenberg, I.H., 1967. *Fiber Morphology in Isenberg I H, Pulp and Paper Microscopy*, third ed. Appleton, The institute of Paper Chemistry, pp. 150–197.
- ISO 4046, 1978. *Paper, Board, Pulp and Related Terms – Vocabulary*. International Organization for Standardization, Geneva.

- Jahan, S.M., Al-Maruf, A., Quaiyyum, M.A., 2007. 'Comparative studies of pulping of jute fiber, jute cutting and jute caddis', Bangladesh. J. Sci. Ind. Res. 4, 425–434.
- Jane, F.W., 1956. The Structure of Wood. Adam and Charles Black, London.
- Jorris, G., 1986. Mathematical theory of low consistency refining of papermaking pulp. ATIP Rev. 40 (10), 507–526.
- Karr, W.E., Gutierrez, C.V., Kinoshita, C.M., 1998. Steam explosion of sugarcane bagasse as a pretreatment for conversion to ethanol. Biomass Bioenergy 14, 277–287.
- Kerekes, R.J., 1990. Characterization of pulp refiners by a C-factor. Nord. Pulp Pap. Res. J. 5 (1), 3–8.
- Khiari, R., Rol, F., Brochier Salon, M.-C., Bras, J., Belgacem, M.-N., 2019. Efficiency of cellulose carbonates to produce cellulose Nanofibers. ACS Sustain. Chem. Eng. 7 (9), 8155–8167.
- Kinsella, S., Gleason, G., Mills, V., Rycroft, N., Ford, J., Sheehan, K., Martin, J., 2007. The State of the Paper Industry. Environmental Paper Network. Available from: www.environmentalpaper.org/stateofthepaperindustry.
- Kissinger, M., Fix, J., Rees, W.E., 2007. Wood and non-wood pulp production: comparative ecological footprint on the Canadian prairies. Ecol. Econ. 62, 552–558.
- Koopmans, A., Koppejan, J., 1997. 'Agricultural and Forest Residues – Generation, Utilization and Availability', Regional Consultation on Modern Applications of Biomass Energy, 6–10 January. Kuala Lumpur, Malaysia.
- Kuniholm, P., 2001. In: Brothwell, D.R., Pollard, A.M. (Eds.), 'Dendrochronology and Other Applications of Tree-Ring Studies in Archaeology' in the Handbook of Archaeological Sciences. John Wiley & Sons, Ltd., London, p. 782p.
- Liu, Z., Wang, H., Hui, L., 2018. Pulping and papermaking of Non-wood fibers. IntechOpen. <https://doi.org/10.5772/intechopen.79017>.
- Liu, X., Jiang, Y., Song, X., Qin, C., Wang, S., 2019. 'A bio-mechanical process for cellulose nanofiber production – towards a greener and energy conservation solution'. Carbohydr. Polym. 208, 191–199.
- Mac Dicken, K.G., 2015. Editorial of the Special Issue of the Review. Forest Ecology and Management, p. 352.
- Miao, C., Hui, L.-F., Liu, Z., Tang, X., 2014. Evaluation of Hemp Root Bast as new raw material for papermaking. BioResources 9 (1), 132–142.
- Mishra, S.P., 2010. 'Blanchiment des Fibres Cellulosiques par l'ozone – Effet sur les Propriétés des fibres'. PhD thesis, Grenoble INP.
- Myreen, B., 1998. 'A Novel Recovery Process for Small-Scale Non-wood Pulp Mill', International Chemical Recovery Conference Proceedings. TAPPI Press, pp. 823–829.
- ONU, 2018. Population. available on. <http://www.un.org/en/sections/issues-depth/population/index.html>.
- Ozenda, P., 2000. Les Végétaux, second ed. Dunod, Paris.
- Paavilainen, L., 2002. Fiber structure. In: Borch, J., Mark, R.E., Habeger, C.C. (Eds.), Handbook of Physical Testing of Paper, second ed., vol. 1. Marcel Dekker Inc., New York, pp. 699–726. part 3.
- Panshin, A.J., De Zeeuw, C., 1964. Textbook of Wood Technology, second ed., vol. 1. Mc Graw-Hill, New York.
- Parham, R.A., Gray, R.L., 1982. The Practical Identification of Wood Pulp Fibers. Tappi Press, Atlanta.
- Petit-Conil, M., Passas, R., Cleuet, J.C., Fournier, R., Voillot, C., 1999. Fibre Characterisation for Understanding the Effect of Plate Pattern on TMP and RMP Quality. München, COST E11 Workshop.

- Pilate, G., 2008. Le bois. In: Hallé, F. (Ed.), *Aux origines des plantes: des plantes anciennes à la botanique du XXI^{ème} siècle*, Paris, Fayard.
- Plomion, C., Leprovost, G., Stokes, A., 2001. Wood formation in trees. *Plant Physiol.* 127, 1513–1523.
- Reis, D., Vian, B., Bajon, C., 2006. *Le monde des fibres*. Paris, Belin.
- Rol, F., Banvillet, G., Meyer, V., Petit-Conil, M., Bras, J., 2018. Combination of twin-screw extruder and homogenizer to produce high-quality nanofibrillated cellulose with low energy consumption. *J. Mater. Sci.* 53, 12604–12615.
- Roux, J.C., Bloch, J.F., Nortier, P., 2007. A kinetic model for pulp refining, including the angular parameters of the equipment. *Appita J.* 60 (1), 29–34.
- Sabharwal, H.S., Young, R.A., 1996. International agro-fiber research initiative. *TAPPI* 79 (12), 66–67.
- Salmen, L., Olson, A.M., 1998. Interaction between hemicelluloses, lignin and cellulose; structure – property relations. Montreal, 9th International Symposium on Wood and Pulp Chemistry (ISWPC) E6, 1–4.
- Saroha, A.K., Wadhwa, R.K., Chandra, S., Roy, M., Bajpai, P.K., 2003. Soda recovery from non-wood spent pulping liquor. *Appita J.* 56 (2), 107–110.
- Schweingruber, F.H., 1988. *Tree Rings. Basics and Applications of Dendrochronology*. Reidel Publishing Co, Dordrecht, D.
- Smook, G.A., 1992. *Handbook for Pulp and Paper Technologists*, second ed. Angus wilde publications, Bellingham.
- Snell, R., October 2002. ‘TCF Bleaching of Flax and Hemp Pulps’, Pira Conference, Durban, South Africa, pp. 8–11.
- Spence, K., Venditti, R., Rojas, O., Habibi, Y., Pawlak, J., 2011. A comparative study of energy consumption and physical properties of microfibrillated cellulose produced by different processing methods. *Cellulose* 18, 1097–1111.
- Tappi standard T 259 sp-05, 2005. Species Identification of Nonwood Plant Fibers, TAPPI.
- TAPPI ISO/TC 6/TG 1, 2015. Summary of international activities on cellulosic nanomaterials. Available at: <http://www.tappinano.org/media/1096/tc6-world-cnm-activities-summary-july-29-2015.pdf>.
- Tejado, A., Nur Alam, M., Antal, M., Yang, H., van de Ven, T.G.M., 2012. Energy requirements for the disintegration of cellulose fibres into cellulose nanofibre. *Cellulose* 19, 831–842.
- Timell, T.E., 1986. *Compression Wood in Gymnosperms*. Springer-Verlag, Heidelberg.
- Tutus, A., Eroglu, H., 2003. A practical solution to the silica problem in straw pulping. *Appita J.* 56 (2), 111–115.
- Uggla, C., Magel, E., Moritz, T., Sundberg, B., 2001. Function and dynamics of auxin and carbohydrates during earlywood/latewood transition in Scots pine. *Plant Physio.* 125, 2029–2039.
- Vallette, P., De Choudens, C., 1992. *Le bois, la pâte, le papier*. CTP, Grenoble.
- Wang, K., Chen, J., Sun, S.-N., Sun, R.-C., 2014. ‘Steam explosion’, chapter 6. In: Sangeeta, P., Negi, S., Binod, P., Larroche, C. (Eds.), *Biomass Pretreatment*. Elsevier, pp. 75–104, 272p.
- Westermarck, U., Samuelsson, B., 1986. The reactivity of lignin in highly lignified parts of spruce during kraft pulping. *Holzforschung* 40, 139–146.
- Winner, S.R., Goyal, G.C., Pye, E.K., Lora, J.H., 1991. Pulping of Agriculture Residues by the Alcell Process. *Proceedings of TAPPI Pulping Conference, Orlando, USA*, pp. 435–439.
- Zhou, H.-G., 2012. A trial production of separate pulping for industrial hemp skin and stem. *China Pulp Paper Indus.* 33 (6), 54–57.

Zule, J., Černič, M., Šuštaršič, M., 2012. Hemp Fibers for Production of Speciality Paper and Board Grades. Pulp and Paper Institute. Viitattu 17.8.2018. Available from: <https://www.gzs.si/Portals/183/vsebine/dokumenti/2012/13-janja-zule-hemp-fibers-for-production-of-speciality-paper.pdf>.

Further reading

Eugropa, 2009. Environmental guide for pulp & paper production. Available from: http://www.eugropa.com/index.php?option=com_content&view=article&id=7&Itemid=6.

Saijonkari-Pahkala, K., 2001. Non-Wood Plants as Raw Material for Pulp and Paper. Academic dissertation, Faculty of Agriculture and Forestry, Helsinki, Finland, 30th of November.

This page intentionally left blank

Environmental textiles from jute and coir

19

P.K. Banerjee

Department of Textile Technology, Indian Institute of Technology, New Delhi, India

19.1 Introduction to environmental textiles

Environmental goods (EG) can logically be defined as products of environment industry. The Asia Pacific Economic Cooperation (APEC) as also the Organization for Economic Cooperation and Development (OECD) define the environment industry as consisting of activities which produce goods and services to measure, prevent, limit or correct environmental damage to water, air and soil, as well as problems related to waste, noise and eco-systems. Clean technologies, processes, products and services, which reduce environmental risk and minimize pollution and material use, are also considered part of the environment industry (Singh, 2003).

There is a scope for debate in this definition as apparently the production process of goods meant to limit environmental damage, for instance an electrostatic precipitator, might itself be found to be causing considerable environmental damage if a lifecycle analysis (LCA) of this product is carried out. Indeed the concept of environmental goods and services (EGS) should be developed around boosting the natural capital, keeping in mind that the human, financial and manufactured capitals are continuously destroying this resource for creating products of our daily utility (Khanna, 2003). It is no understatement that a sharp decline in global economic indices as a whole in not too distant a future is foreseeable if this trend is not reversed. In this sense the environment industry should be primarily concerned with clean technologies, processes, products and services that reduce environmental risk and minimize pollution and material use.

The eco-friendly and sustainable concept of economic activity leads one to the regime of environmentally friendly goods (EFG) that should at every stage — starting from generation of raw material, manufacture and use to distribution and disposal of the products be non-toxic and of low environmental impact. Products with low environmental impact should not create environmental problems when (a) the raw materials from which they are produced are cultivated or extracted or generated and (b) they are actually produced and used. Such products should also not generate toxic byproducts when they are eventually disposed off. In this sense, biodegradable products created from raw materials which grow in nature and are renewable have an inherent advantage over products, which need to be initially synthesized and later on either incinerated or dumped in landfills at the end of their lifecycle (Anon, 2002a,b). As an example one may consider the case of packaging materials made on one hand from a natural biodegradable material such as jute as against a similar product made from a synthetic non-biodegradable material such as polyethylene

(PE). The former is made of renewable material, converted to the final product by a process with very low environmental impact, while the use and disposal poses absolutely no environmental concern. The packaging materials made of PE on the other hand owe their origin to a raw material even the extraction of which has considerable impact on the ecosystem. Similarly the conversion processes, the use as also the disposal of this non-biodegradable packaging material are all causes of considerable environmental concern. Clearly then the jute packaging material can be categorized as EFG. Economic activities involving EFGs should result in reduction of waste (jute packaging material can be recycled manifold and for many purposes till the degraded residues are returned to nature) and thus lead to a recycle-oriented society. Keeping the overall concern of the ecosystem in focus it would be highly desirable to assign top priority to support and promote EFGs internationally. A separate category termed as EFG may be added to the list of EGS thus making it more representative of the products of the environment industry.

Keeping the broad sentiment of the term EFG in view, the cultivation, conversion and disposal of a large number of products of jute and coir fibres can be logically termed as environmental textiles.

19.2 The importance of jute and coconut plant cultivation

Jute cultivation is primarily restricted to India and Bangladesh, accounting approximately for 57% and 41% (Table 19.1), respectively of the world production of about 3.3 million tonnes in 2016 (FAOSTAT, 2018). The yield in tonnes/hectare works out to be 1.98, 2.48 and 3.3, respectively for Bangladesh, India and China. Due to a 1.62 times net rise in yield between 1961 and 2016 the global jute production has gone up 1.24 times although area under cultivation has gone down 1.3 times (Table 19.2).

Jute occupies the most important place among the bast fibre crops in India. It is grown on around 0.765 million-hectare land. Between 1961 and 2016 the land area under jute cultivation in India has gone down 1.2 times while the yield has gone up nearly two times. Research and development work carried out by the agricultural scientists during this period has not only resulted in increasing yield of the fibre but also in improvement of the fibre quality and shortening of the cultivation period.

Table 19.1 FAO estimate of World production of jute fibres in 2016.

Country	Production (1000 tons)
Bangladesh	1, 344.0
China	39.7
India	1, 900.4
Nepal	11.6

Table 19.2 A comparative overview of jute, coconut and coir fibre cultivation in 2016 *vis-a-vis* 1961.

Variables	Location	Jute		Coconut		Coir fibres	
		2016	1961	2016	1961	2016	1961
Production (tonnes)							
	Global	3,309,874	2,663,906	59,327,215	23,509,475	1,214,119	358,368
	Bangladesh	1,344,000	1,314,540	92,417	49,786	10,456	6368
	India	1,900,433	1,144,400	11,127,898	3,328,000	561,447	166,500
	Indonesia			17,722,429	5,650,000		
	Philippines			13,825,080	5,023,200		
	Sri Lanka			2,520,095	1,948,950		
	Thailand			815,406	979,000		
	Vietnam			1,469,960	153,400		
Area under cultivation (ha)							
	Global	1,469,428	1,909,894	12,202,148	5,260,283		
	Bangladesh	677,678	834,000	43,000	17,800		
	India	765,105	917,000	2,155,749	723,000		
	Indonesia			3,105,259	1,130,000		
	Philippines			3,565,059	1,199,880		
	Sri Lanka			408,918	433,400		
	Thailand			177,063	185,120		
	Vietnam			146,835	42,400		
Yield (tonnes/ha)							
	Global	2.25	1.39	4.86	4.47		
	Bangladesh	1.98	1.58	2.15	2.8		
	India	2.48	1.25	5.16	4.6		
	Indonesia			5.7	5.0		
	Philippines			3.88	4.19		
	Sri Lanka			6.16	4.5		
	Thailand			4.61	5.29		
	Vietnam			10.01	3.62		

Investigations reveal that the crop pattern jute-paddy-potato is more profitable for the farmers than say paddy-potato-sesame.

Rahman et al. (2017) reports that about 0.576 million-hectare land is under jute cultivation in Bangladesh and there is potential to improve land area as also productivity in future. Three million farmers are reported to be engaged in jute cultivation in Bangladesh. According to FAOSTAT (2018), the land area under jute cultivation in Bangladesh has gone down 1.23 times between 1961 and 2016 while the yield has gone up 1.25 times.

After being allowed to grow for 4 months (April onwards) the plant (Fig. 19.1) is harvested, leaving the root portion in the soil. The harvested jute plants are then allowed to dry up, shedding leaves in the process (defoliation). The roots left behind in the soil as also these dry leaves form important nutrition for the subsequent cultivation. Paddy cultivation with the assistance of fertilizers has been found to cause the soil to gradually lose cohesion requiring progressively higher inputs, thus pushing up the cost of the product. As a result, paddy cultivation is fast becoming non-profitable in many traditionally paddy-growing areas. However the rotting roots and leaves of the jute plant not only add nutrient to the soil but also result in humus, which helps to enhance/maintain the soil cohesiveness. Jute fibre has many inherent advantages, the most important of which is its eco-friendliness. Being annually renewable through a traditionally simple cultivation process — in which incidentally jute crop forms an important element in a three-crop pattern — it is also highly sustainable (Braungart et al., 1992; Groenewegen and Van Overbeeke, 1994). In fact there is a strong case for including the products of this material in the group of “Environmental Goods” sector so that a free international trade in jute goods may flourish for enabling the global consumer to benefit from the same (Banerjee, 2003).

The dried jute plant yields two important products namely the jute fibre and the jute stick. The fibre and the stick are extracted from the jute plant by a controlled rotting process, known as retting. The jute stick forms an important fuel for the farmers during

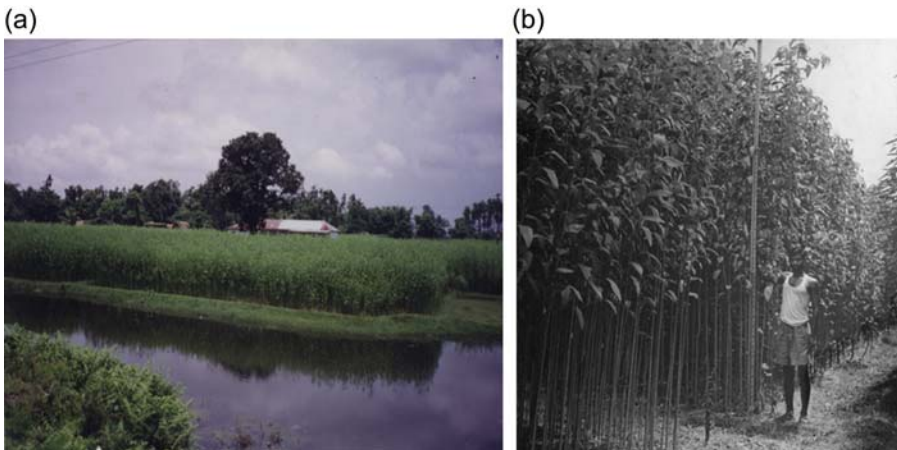

Figure 19.1 View of (a) cultivated field with jute plants and (b) fully grown jute plants. Source IJIRA, Kolkata.

rainy season and it is claimed that even if jute cultivation becomes uneconomical for the farmers they would continue to grow some amount just for the sake of the fuel it yields. Incidentally it has been estimated that about 1.2 kg of CO₂ is absorbed from the atmosphere per every kg of fibre produced (Anon, 2002b).

The coconut plant is grown around the world in lowland tropical and subtropical habitats and is one of the most economically important palms. From this species come many natural products, including foods, drinks, fibres, building materials, and chemicals. This species can be grown where annual precipitation is fairly low, and it does well growing near salt water, where salt spray would kill many other plants. The coconut is a tropical plant, and grows in temperatures between 20 and 25°C, but the best temperature is 27°C. It is usually found growing along the coastline. The plant is surprisingly drought tolerant, but adequate soil moisture is necessary for good fruit production. Coconuts tolerate salty, sandy soils and thrive in the lowland tropics, usually but not necessarily, on the seacoast. The plant is grown only from seeds and transplanted once (or more) before being set in a permanent place. The plant produces fruits from the sixth year onward until the tree is about 80 years old. A well maintained tree could grow 80 feet tall and should yield over 75 nuts a year (Prabhu, 1956). However the dwarf varieties can be as short as 20 feet while coconut tree in the wild can survive for nearly 100 years.

All parts of coconut plant are useful. The white, fleshy part of the nut is edible and the cavity is filled with 'coconut milk' containing sugars. Toddy is an English name for the fresh beverage obtained from the sap, which is derived from incising the flower clusters of coconut. Coir is the fibre contained in the coconut husk and is used for making ropes, mats, brushes, calking boats and is also used as stuffing fibre. Copra is the edible dried meat or hard endosperm of the fruit. Oil expressed from the dried endosperm can be used in soap production or as cooking oil. The trunks provide building timbers, the leaves provide materials for thatch and the husk and shells can be used as fuel.

Coconut is grown in more than 93 countries in the world in an area of about 12.05 million hectares and yield 61,165 million nuts (Arancon, 2008). As per the Government of India statistics 2008–09, India was the largest producer of coconut in the world with a production of 15,840 million nuts, accounting for 26.9% of the global production (Anon, 2010). According to FAOSTAT (2018) however (Table 19.3) India's share in the global production of 59.33 million tonnes of coconuts in 2016 was 18.76%. Much smaller countries like Indonesia and Philippines produced much higher quantity of coconuts – 29.87% and 23.3%, respectively – than India in 2016. However, only a small fraction of the coir fibres that can be obtained from the nuts produced globally are actually extracted for industrial use. Thus although coconuts are produced in 96 countries, only seven are reportedly extracting coir fibres so that applying the thumb rule that coir fibres constitute about 30% of the mass of the dry coconut and considering that the estimated global production of coir fibres in 2016 was about 1.21 million tonnes (FAOSTAT, 2018), only about 7% of the potential fibre crop is apparently being utilized for downstream processing while a whopping 93% remains unaccounted for.

Table 19.3 Global production of coconuts and coir fibres in 2016.

Country	Production of coconuts		Production of coir fibres	
	Thousand tonnes	% Of total production	Thousand tonnes	% Of total production
Bangladesh	92.42	0.16	10.46	0.86
Brazil	2649.23	4.46	—	—
Ghana	380.38	0.64	39.89	3.3
India	11,127.9	18.76	5,614.5	46.2
Indonesia	17,722.43	29.87	—	—
Malaysia	504.74	0.85	21.13	1.7
Mexico	1157.48	1.95	—	—
Philippines	13,825.08	23.3	—	—
Thailand	815.41	1.37	61.38	5.05
Sri Lanka	2520.1	4.25	159.54	13.14
Vietnam	1469.96	2.48	358.11	29.5
Other 84 countries	7062.09	11.90		
Total	59,327.22		1214.12	

Production of coir fibre takes place in small- or medium-sized units, mainly in India, Vietnam, Sri Lanka and Thailand (Fernandez, 2003). During the 1990s, production in India expanded by 8.2% annually in order to meet domestic demand, while in Sri Lanka, a major exporter of coir fibre, production contracted due to weakening export and domestic demand. It is projected that most of the expansion in global production would take place in India, with some modest growth in rest of the coir producing countries. Out of the total global production of coir fibres in 2016 of about 1.21 million tonnes, the share of India, Vietnam, Sri Lanka and Thailand were 561 (46.2%), 358 (29.5%), 159 (13.14%) and 61 (5.05%) thousand tonnes, respectively (Table 19.3). This high Indian share is in spite of fibre extraction from only 17% of the nuts produced in the country. The rest of the potential fibre source either becomes garbage or is dried and used as fuel. In Vietnam 81% of husks are converted to coir fibres, while in Sri Lanka and Thailand the conversion figures are 21% and 25%, respectively. Quite surprisingly Philippines and Indonesia, accounting together for about half of the global production of coconuts do not figure at all in the list of coir fibre producing countries. In terms of yield in tonnes/ha all the major coconut producing countries have registered a growth between 1961 and 2016 whereby the 2.77 times rise in yield (Table 19.2) registered by Vietnam is most remarkable. Apparently the cultivation of coconut and extraction of coir fibres for industrial use is taken most seriously in Vietnam.

From the foregoing it is observed that the cultivation of jute plant is carried out primarily for production of the fibre and the stick as also in gainfully utilizing the soil during a 4-month period between two crops in a 3-crop rotation scheme. However, the cultivation of jute is by and large restricted to the eastern and northeastern part of India and neighbouring Bangladesh, a relatively small patch on the globe. The cultivation of coconut plant has on the other hand a very different focus – coir fibre being one of the many useful byproducts – extending over a much larger time frame and spread over a much wider area of the globe. Even then there are striking similarities between the two when one considers that

- In terms of jute fibre production India and Bangladesh are the two major global players while in terms of coir fibre production India, Sri Lanka and Vietnam are the major nations.
- Both these plants have considerable economic importance for the major growing countries.
- The jute and coir fibres have similar chemical composition, i.e. both are lignocellulosic
- Products of both of these fibres are utilized globally and face a common challenge from synthetic fibres
- There is considerable scope of broadening and improving the product base of these two fibres by injecting necessary inputs in the respective agriculture and downstream industry sectors. This would not only bring more eco-friendly materials to the global consumer but also contribute to better utilization and hence in reduction of waste of the raw materials.
- The major shortcoming of the industrial exploitation of jute and coir fibres concerns the fibre extraction process, commonly known as retting.

19.3 Extraction of jute and coir fibres

The traditional retting of jute plant involves submerging the plants in water. As a result the bark of the stem swells resulting in cracks and crevices in the cortex. Microorganisms, present on the plant as also in the surrounding water and soil system, then enter through these openings and start attacking the pectinous binding matter loosening in the process the long fibres located along an annular ring between the outer periderm and the inner cambium of the bark. In addition to the solubilized binding matters, other soluble matters such as Tannin etc. from the plants are also released in water during this process of retting. The retting process produces organic acids, acetone, ethyl alcohol, butyl alcohol and various gases such as methane, carbon dioxide and hydrogen sulphide (Anon, 2002b). As this process is carried out in batches over a period of a month or so, the water bodies surrounding the farmer's field as also the surrounding air gets fouled up during this activity. Moreover the quality of fibre too suffers considerably as a result of this uncontrolled batch process. Subsequently the recuperative process of nature brings the water bodies and air back to equilibrium over a period of time. However the water left behind after retting contains many nutrients and has been found to be a supplemental nutritional source for the growth of the next crop i.e. rice. Considerable amount of laboratory experiments and field trials have been and are being conducted for developing improved retting methods, which would have less environmental impact and also lead to improved fibre quality.

Expectedly, superior and a wider range of products can be developed from superior fibres. Clearly if the international community supports the cause of this fibre and makes room for more products for the consumer, this one objectionable feature of the jute sector can soon become part of the history.

A very similar scenario prevails in retting of coconut husk for extracting the fibre. Traditionally retting is carried out by submerging the husks in pits created adjacent to the backwaters (Fig. 19.2) that prevail along the coastline. Regular flushing of such pits by the brackish seawater is instrumental in assisting the microorganisms to breakdown the gummy binding matter and loosen the coir fibres. As opposed to about 12 days needed for retting a batch of jute plants, a batch of coconut husks needs about 9 months. In addition to the coir fibre, retting of coconut husk also yields the coir pith – a highly durable granular and micro-porous substance of high moisture retentivity, which can also be converted to a number of useful products.

Besides this biological process, a mechanical fibre extraction process of coir fibres is also practiced, which however does not yield good quality fibre and is therefore meant for low value added products. An enzymatic retting process is also in vogue for improving the cleanliness of the mechanically extracted fibre. However for various reasons this process has not yet been widely accepted.

19.4 Critical properties of jute and coir fibres

Jute and Coir are two very different types of lignocellulosic fibres. Chemically, jute and coir are composed of three principal constituents, namely α -cellulose, hemicellulose and lignin. For jute fibres from Bangladesh, the range of composition has been given as 12%–14% of lignin, 58%–63% of α -cellulose and 21%–24% of hemicellulose (Rowell and Stout, 1998). Satyanarayana et al. (1982) found that α -cellulose, hemicellulose and lignin content of coir fibres vary in the range of 32%–43%, 15%–25% and 40%–45%, respectively.



Figure 19.2 Coconut grove with backwater and retted husks.

While jute is a bast fibre, extracted from the stem of 110 to 120-day-old jute plant, coir is extracted from the dried husk surrounding ripe coconuts growing on very tall trees that bear fruit from sixth year onwards. Jute fibres lend rigidity to the thin and tall plant stem and therefore exhibit fairly high tensile stiffness (high modulus of around 24–27 N/tex, moderate tenacity of 35–40 cN/tex and very low elongation at break of 1%–1.5%). Coconut husk consists of a bed of coir fibres of varying length and thickness surrounding the nut, i.e. the husk is meant to absorb shock and protect the nut from damage upon its nearly 80-foot fall from the top of the plant. The fibres have therefore low modulus (0.9–1.5 N/tex), low tenacity (11–14 cN/tex) and very high (40%–45%) elongation at break (Banerjee et al., 2002). The extremely high resistance to rotting caused by presence of very high percentage of lignin in coir fibres sustains the nut on a long voyage along waterways for propagation of the species. The lignin content of jute fibre is on the other hand more than sufficient for enduring the elements of nature during the short lifespan of a jute plant. Evidently in spite of basic similarities in composition, the two fibres complement each other in quite a few critical properties. In addition to observing a pronounced stick-slip phenomenon of the load elongation behaviour of coir fibres, Guha (1995) found that the shape of such a curve to be essentially different from that of jute in that coir fibres demonstrate a higher initial modulus and lower offset modulus while the reverse holds true for jute. Some of the relevant physical properties of jute and coir fibres are listed in Table 19.4.

19.5 The nature of commercial products from jute and coir

Commercially important products manufactured from jute and coir fibres are listed in Table 19.5.

The principal outlet of the jute products is in the packaging sector. Jute fabrics are widely used in India for packaging food grains, sugar, pulses and seeds. Special food

Table 19.4 Some typical physical properties of Jute and Coir fibres (Guha, 1995).

Property	Jute	Coir
Thickness	65 μ	100–450 μ
Density	1.45%	10%–12%
Microfibrillar angle	7 to 90°	30 to 49°
Initial modulus	197 cN/tex	85.7–156.5 cN/tex
Offset modulus	1082–1311 cN/tex	9.5–18.5 cN/tex
Tenacity	23.9–27.6 cN/tex	11.5–14.5 cN/tex
Elongation at break	2.3%–3%	15%–40%
Specific flexural rigidity	0.29–0.39 mN-mm ² /tex ²	0.2–0.35 mN-mm ² /tex ²
Flexural rigidity	3.5–4.5 mN-mm ²	71.4–1254.6 mN-mm ²

Table 19.5 Commercial products from Jute and Coir fibres.

Product	Jute	Coir
Yarn	Plied yarn, Twine yarn	Plied yarn, Ropes
Conventional fabrics	Sacking, Hessian	Mats, Mattings
Other fabrics	Canvas, Tarpaulin, Carpet backing, Carpets	Rugs, Carpets
Designed products	Geotextiles, Composites	Rubberized Mattresses, Geotextiles

grade jute bags have been developed for satisfying stringent international norms of safety. Jute shopping bags of various shapes, sizes and designs are nowadays a common sight in many towns and cities. Jute geotextiles are being increasingly used in India to solve geotechnical problems which do not demand very high durability of the geotextile material. In fact biodegradability of the substance is viewed as a very welcome feature as after the useful lifespan, the material can decompose and merge with the surrounding soil. It is claimed that in this process the soil is also enriched. Jute composites are increasingly being used in the railways and in the building sector as wood substitute.

Majority of the coir products are meant for the floor-covering sector. Ropes and yarns of coir have and are being traditionally used in building, shipping and other sectors. The mats, mattings, rugs and carpets differ in construction, method of production, dimension, appearance and feel. These are very rugged, relatively heavy, stable and durable utility items meant for household, offices, marketplaces etc. Coir geotextiles enjoy similar applications as jute geotextiles although there are significant differences in their properties and hence these two can play supplementary and complementary roles. Rubberized coir mats and mattresses are well-accepted household and office utility items.

Relatively simple, labour intensive and sometimes very crude techniques are used to convert the fibres into the products listed in the Table, although for some products – for instance jute-based carpets – somewhat sophisticated technologies are employed. The level of sophistication obviously depends on the price that the product is going to fetch. It is a hard fact that jute and coir fibres and their products are traditionally low priced items. This has forced the respective agriculture and industrial sectors to be very wary about any costly inputs, which has resulted in a culture of stagnation. This scenario is further complicated by the high cost of transport, as the products are heavy and bulky, causing at times an addition of more than 100% to the landed cost. Any cost relief provided by the trading practices as also fiscal measures of the concerned authorities would help the jute and coir sectors to survive. Growth of these sectors would ultimately depend on innovation in processes and products, which can be strongly influenced by market pull. Thus if there is an international effort at protecting and promoting these EFGs, innovations in process (such as improved retting) and in

products (such as lighter and denser packaging material) may follow. The resultant higher value added products could then start fetching a higher price and such a development could have a cascading beneficial effect on the overall health of these sectors.

19.6 Some novel environmental textiles from jute and coir

The products described in the following satisfy the criteria listed below:

- Both fibres are products of nature and should be highly compatible for end uses related to soil, water and plants
- The products should have global appeal
- The production process should be simple and non-polluting. This would keep the cost of the product low and be in tune with the overall appeal of the product

19.6.1 Pre-seeded erosion control blanket (PsECB)

The suitability of jute, coir and sisal fibres for geotechnical end uses is well documented in literature (Banerjee and Unni, 1997; Oosthuizen and Kruger, 1994). Ingold (1994) in his report on the mechanics of soil erosion by wind, water and gravity and its control through biotechnical measures, had underlined the importance of short-term protection of soil provided by a preformed erosion control mat during the absence of vegetative cover and quantified the same by the parameter *yield factor*. In this respect, the results of initial tests using a rainfall simulator indicated supremacy of natural fibre products over their commercial synthetic counterparts. While evaluating various types of woven and non-woven commercial jute fabrics for their suitability in erosion control, Rickson and Loveday (1996) concluded that for preventing loss of soil, it would be desirable to use a product with a cover which is as close to 100% as possible. This observation pointed to the advantage of using non-woven jute fabrics. However, a good soil protection function has to be supplemented by vegetable establishment function. In this respect, the jute non-woven products, which in fact are used as anti-weed (Jayachandran and Dutta, 1997), were found unsuitable. They hinder growth of vegetation, being neither sufficiently transparent to permit passage of required quantity of light to the germinating seeds nor sufficiently open to allow an easy passage to the shoots. Moreover, for wind erosion control application, the geotextile material must be permeable to wind; otherwise billowing takes place. As a result, jute non-wovens were rejected as potential erosion control material and the very open (40% cover) and very heavy (500 g/m²) woven Geojute was recommended as the most suitable material. It is, however, quite conceivable to develop a non-woven fabric based on the blend of jute and a suitable natural fibre that would lead to a more open and bulky material, permitting both light and space for growth of vegetation. Considering the two aspects of compatibility and availability (Guha, 1995), coir was chosen as the second component. An intimate blending of jute and coir fibres was therefore

undertaken for needle punching the blended material into the required product. As a considerable amount of erosion takes place along the denuded slopes of mountainous terrains where seeding the surface can be difficult, it was decided to explore the possibility of trapping suitable seeds in the non-woven fabric during the process of needle punching itself. Such a pre-seeded fabric would just need to be spread on a slope and suitably watered for the seeds to germinate and vegetation to take root.

Coir fibres extracted from dry coconut husk exhibit a wide range of dimensions. The fibre length varies between 50 and 300 mm and the diameter between 0.1 and 0.4 mm in such a way that the longer fibres are also thicker. For the purpose of blending with jute and needle punching, only the thinnest coir fibres come into question. These fibres are referred to as mattress fibres. A method was developed to segregate the mattress fibres from the husk during the mechanical extraction process itself. Subsequently, these fibres were thoroughly cleaned in Rotary Screener and Decorticator so as to achieve nearly zero pith content. The mattress fibre length so obtained was in the range 100–150 mm. These fibres were treated with an emulsion of cationic softener for reducing their flexural rigidity. Preliminary experiments were then carried out to estimate optimum combination of jute and coir fibres as also the desirable level of softener treatment. As a result a 50:50 jute-coir ratio with a 0.5% softener treatment for the coir fibres was inferred as the best combination for blending the two fibres under consideration (Banerjee, 2001). Needle punching the blend was carried out by processing the same first on a jute Garnett card, followed by cross-lapping the web suitably into the desired batt. The batt was then fed to a needle punching machine along with a suitable jute scrim. After one passage of punching the jute-coir batt on the scrim, the punched felt was wound up on a cloth roller. The unpunched side of the felt was then fed to the punching machine along with a fresh layer of jute-coir batt on top and the assembly was punched again. During this process variables such as feed rate, punching density and depth of penetration were varied systematically to locate the optimum combination of a compact, light and reasonably strong blanket. As a result the process variables for production of a 380 g/m² blanket were established. For pre-seeding this blanket during the production stage itself, the seeds were fed just ahead of the punching zone into the gap between the unpunched and the punched layers along the machine width during the second passage. The seeds were thus firmly trapped in the fibre matrix.

The experimental PsECB was laid on prepared soil and watering was done regularly. Part of the seeds did germinate within a period of 2 weeks, as can be observed from Fig. 19.3. The clear opening that the shoot and the root of the germinating seeds could create in the blanket underlines that the blanket is fairly open and, therefore, can be employed for the purpose of erosion control through reestablishment of the vegetation.

19.6.2 Jute-coir prefabricated vertical drain (PVD) (Brecodrain)

Consolidation of soft soil, encountered in marshy land or along the shoreline of a river or sea, involves subjecting the soil mass to a compressive load with a view to effecting a reduction in inter-granular space. An application of surface load results in a

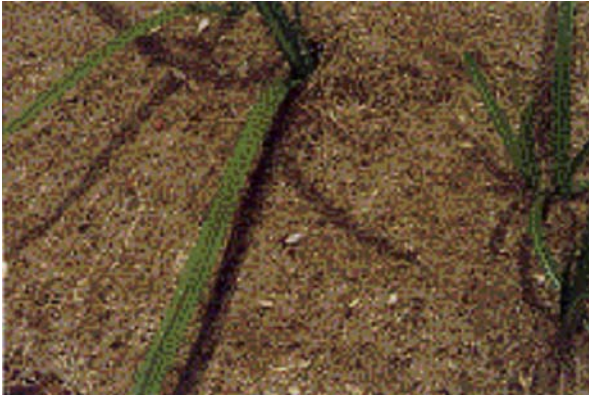

Figure 19.3 Germinating seeds in PsECB.

consequent increase in the pore pressure of the saturated soil (Baron, 1948). This can be brought down quickly by draining out water under pressure from the pore spaces, thereby transferring the compressive stress to the soil grains. The traditionally economical method of accelerating the consolidation process involves the use of vertical sand filled cylindrical holes known as sand drains. Such drains are, however, liable to clog during the course of consolidation as well as undergo shear deformation during the settlement. Moreover, the drains may under circumstances act like columns preventing complete vertical settlement. Prefabricated vertical drains (PVD) have been increasingly replacing sand drains in view of their consistent qualities, ease of transport and installation, non-clogging potential, high discharge capacity and low smear effect (Hansbo, 1979). Typically such PVDs exhibit a filtering sheath, which encases a core of diverse materials, forms and shapes. Detailed studies pertaining to properties and performance of such drains made of synthetic materials have already been carried out in some detail (Akagi, 1994; Chen and Chen, 1986; Hansbo, 1983; Holtz and Christopher, 1987; Koerner, 1990; Oostveen and Troost, 1990; Rathmayer and Komulanein, 1992). The performance of synthetic PVDs is, however, expected to be adversely affected through kinking of their relatively rigid cores (Rawes, 1997) caused by settlement of soil. Moreover, the duration of the consolidation process is in terms of months, thus rendering the presence of the synthetic drain within the soil mass over many years quite unnecessary, if not objectionable. Robust natural fibres, such as jute and coir, have on the other hand the right kind of durability for such applications and a suitable drain can therefore be constructed from jute and coir yarns. Such drains, after having fulfilled their functions, would gradually degrade and merge with the surrounding soil. Considering the large volume of consumption of such drains (Akagi, 1994), it is evident that such a product, when commercialized, could also become an important outlet for jute and coir fibres.

A detailed report on the method of production of this PVD, braided from jute and coir yarns, has already been published (Banerjee et al., 2000). It involves braiding a band of jute yarns into a sheath for encasing a number of parallel coir yarns in the



Figure 19.4 View of a Breco drain.

core. The view of one such drain is shown in [Fig. 19.4](#). The sheath is stabilized in the length direction by a number of axial yarns also made of jute. The count and the number of each of the sheath, axial and core yarns can be varied over a wide range to produce a range of Breco drain.

A large number of samples of Breco drain were generated in the laboratory for studying their dimensional, tensile and structural properties. Based on this study, some samples were selected for investigating their hydraulic (permeability and pore size distribution) and performance (discharge capacity) properties. Two commercial drains, one of them made of synthetic materials (coded as S) and the other made from natural materials (coded as N), were also tested simultaneously for the sake of comparison. As a result it could be concluded that the performance of Breco drain is comparable with the commercial drains tested. The Breco drain, however, shows better discharge in the kinked condition and under hydrostatic pressure than the commercial drains chosen for comparative study. This kinked condition is expected to develop when the soil starts settling owing to consolidation. During this process, elements of the flexible Breco drain readjust themselves and continue performing better than the compared drains. Results of this particular study have been plotted in [Fig. 19.5](#). The two samples of Breco drain (coded F1 and I) show initially a lower rate of discharge than the two commercial drains in the straight condition. However, with increase in hydrostatic pressure, the performance of the N drain exhibits a sharp drop and falls below that of the Breco drain. The S drain retains, however, the superiority throughout the pressure range of 0–200 kPa. This scenario changes drastically on kinking and the performance of the S drain starts dropping sharply with every increment of kink so much so that at the 30% kink level, it falls considerably below that of the Breco drain.

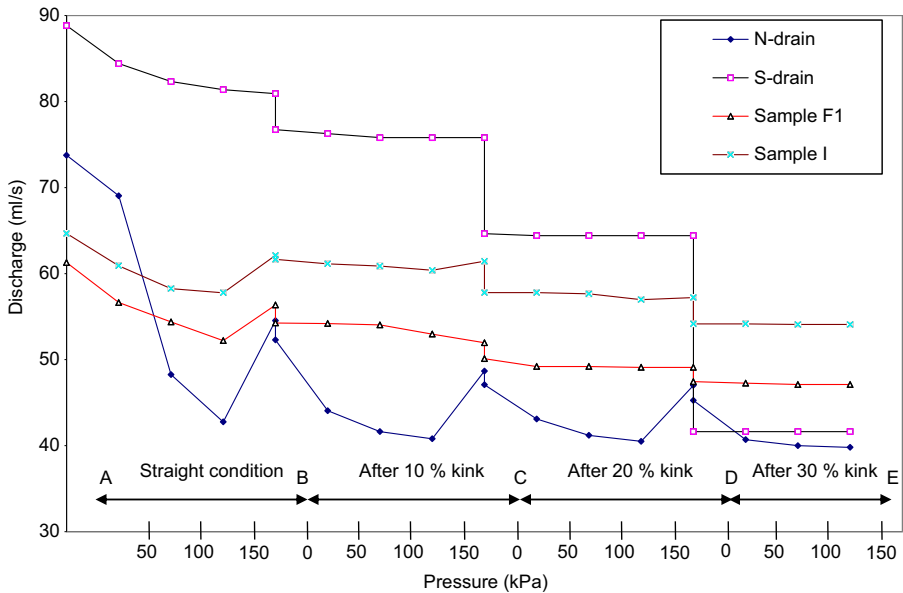

Figure 19.5 Pressure and kink dependent discharge capacity profile of various drains.

Results of this study would suggest that whenever a large settlement is expected, the Brecodrain should prove superior to the other drains in all respects.

The studies on discharge capacity also led to a better insight into the mechanics of the process. It was found that the numerous fine channels oriented along the axis of the drain, which are located in the sheath, in the core and between the core and the sheath, are eventually responsible for the discharge capacity. Finer and more numerous the channels, higher is the discharge capacity. Depending on the compressional rigidity of the drain, these channels get blocked to varying degree on application of pressure, affecting the discharge in the process. Hence, the finest core yarns in large number in conjunction with a thin sheath, braided from the finest available jute yarns, would yield the highest discharge.

19.6.3 Jute-asphalt overlay fabric (JAO)

Asphalted pavements are subjected to distress due to traffic loading that cause differential deflections in the underlying pavement layers, as also due to ambient temperature fluctuation that results in expansion or contraction of the subgrade (compacted soil foundation) and of the pavement itself (Lytton, 1989). Reflection cracking is one of the major distresses frequently encountered in asphalt concrete (AC) overlay in which the existing cracking pattern from the old pavement propagates up into and through the new overlay (Dempsey, 2002).

Asphalts or bituminous binders of various grades are widely used in flexible pavements due to their good adhesion to mineral aggregates and viscoelastic properties.

Hence, during rehabilitation of old cracked roads, asphalt overlay (A/O) fabrics are placed between new AC overlay and cracked pavement for preventing upward flow of crack from the old pavement to the new one.

From the developmental history of A/O fabrics, a transition can be observed in selection of raw materials and construction, from non-woven spun-bonded or needle-punched structure of common synthetic fibres like PP and polyester towards grids and composite structures made of high modulus fibres like Kevlar and fibre glass. But no standard A/O material made up of natural fibres has ever been tried out although some of the natural fibres like jute, sisal, hemp, flax and ramie have mechanical properties better in many respects than PP or polyester. Natural fibre like jute is known to have good adhesion with bitumen as is evident from the widespread application of bituminized jute fabric. Hence, it is logical to develop A/O fabrics from jute which is relatively inexpensive and available abundantly in India, Bangladesh and some neighbouring countries.

A pavement needs a durable protection. A jute-based product may not last long enough when subjected to elements of nature due its biodegradability. To this end, investigations on mechanical behaviour of jute in asphaltic medium upon hygral treatment and enzyme treatment simulating microbial attack reveal that hygral treatment of even 6 month period is ineffective in damaging the jute-asphalt interface and the encased jute because asphalt acts as protector for jute against microbial attack (Banerjee and Ghosh, 2008). Consequently a 100% jute-based asphalt overlay fabric (JAO) of moderate capability suitable for major district roads and rural roads has been developed and its in situ performance within pavement in preventing reflective crack propagation under accelerated dynamic load, simulating the traffic load, has been investigated. Additionally, its efficacy to retard crack propagation after hygral loading has also been evaluated through similar accelerated dynamic loading tests.

The A/O fabric was designed for the following characteristics:

- A grid-like structure with suitable aperture size which would help in creating strong anchorage with the surrounding aggregates
- This grid structure should have high modulus, i.e. moderately high breaking load with low breaking extension in length and width directions to ensure low deformation under load.
- Additionally, the grid should be linked with an asphalt absorbent layer

It was decided to initially aim at the following specifications for JAO fabric:

1. A breaking load in the region of 40 kN/m in both length and width directions
2. A breaking elongation lower than 5% in both length and width directions
3. Grids on fabric surface with opening size in the range of 10 mm
4. Ability of absorbing bitumen and forming a continuous impermeable layer

Jute yarns are made of relatively thick fibres (1.67–2.22 tex), resulting in diameter ranging between 0.7 (for 8 lb or 275.6 tex yarn) and 1.8 mm (for 64 lb or 2204.8 tex yarn). Hence when such thick yarns are woven into a plain or twill fabric, very high values of crimp in the yarns are encountered. The resultant fabrics therefore exhibit high extensibility. However a leno weave made of thick and strong standard warp yarns together with thick and strong weft yarns bound together by thin doup warp

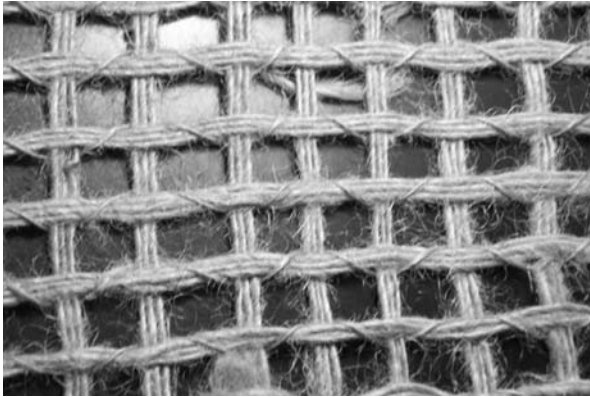

Figure 19.6 The Leno structure of the JAO grid.

yarns can yield a product, exhibiting very marginal crimp in the load bearing directions. Such a construction, shown in Fig. 19.6 was employed for the basic load bearing grid. At proper intervals between these load bearing threads, plain woven bands of much thinner warp and weft yarns can be incorporated for acquiring the required asphalt-absorbency. Similarly supply of two different types of weft yarn and an adjustable take up mechanism for weaving alternate bands of plain and leno are also necessary for developing such a product. In the case of non-availability of such a loom, one can produce the grid and the absorbent woven or non-woven fabric separately and subsequently sandwich the latter between two layers of the grid as shown in Fig. 19.7.

The evaluation of efficacy of JAO in retarding growth of reflection cracks due to mechanical and hygral loading can be carried out by designing cyclic mechanical loading tests involving bending and shear strains. For evaluating “fracture properties” of the asphalt concrete beams (ACBs) with and without JAO fabrics, the three-point bending mode was chosen for carrying out accelerated beam cyclic mechanical loading tests. Accordingly it was planned to carry out a three-point cyclic mechanical loading test program with semi-continuous support (Brown et al., 2001) on ACBs using a suitable MTS (Material Testing System) where the frequency and amplitude of loading could be so varied as to impose a strain rate well above that expected to be encountered on, for example a typical low traffic road, like a district road in India. Based on literature as also requirements of accelerated test, the following mechanical loading regime was selected:

- Range of amplitude of loading: min., 28.79% of breaking load of ACB in static loading; max., 71.21% of breaking load of ACB in static loading.

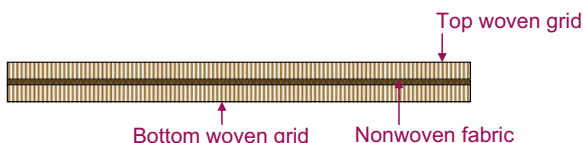

Figure 19.7 Proposed sandwich structure of JAO fabric.

- Ratio of minimum to maximum load during a test cycle: 0.1.
- Range of frequency of loading: min., 10.76 Hz; max., 19.24 Hz
- Nature of loading: Sinusoidal

The effect of hygral loading was studied on unreinforced ACBs and ACBs embedded with JAO. To this end, beam specimens were subjected additionally to two different levels of hygral treatment by immersion under water for 15 and 30 days, respectively. Subsequently, the ACBs were removed from water and subjected to the specific identified loading conditions.

Samples of Asphalt Concrete Beams (ACB) were prepared with reinforcement of A/O fabric, placed at 20 mm above the beam specimen-base. A transverse notch of 5 mm depth and 3 mm base-width at the beam-centre was created to simulate a pre-existing crack in the old pavement. Before testing the ACBs on MTS, both the side surfaces of the beams were painted with white road-paint and marked with horizontal red lines at intervals of 5 mm up to 30 mm level above the beam-base, as shown in Fig. 19.8, to record the crack height with number of loading cycles during test. For testing the efficacy of the JAO vis-à-vis non-reinforced ACBs, the load was kept at 0.78 kN, while a moderate frequency of 15 Hz was chosen. This permitted a reasonable number of test cycles to failure, both from the point of view of accuracy as also test duration.

Experimental results reveal that under all experimental conditions, ACBs embedded with JAO do not exhibit any crack propagation beyond the level at which the JAO is placed within the ACB. Moreover, in many cases the crack initiated at the notch did not grow at all. A typical photograph of crack propagation in JAO reinforced ACB (Fig. 19.8) confirms this observation. The photograph of an unreinforced ACB that got cracked at the same average load but after a much lower number of cycles is shown in Fig. 19.9 for comparison.

The experimental data pertaining to hygral loading of unreinforced ACBs exhibit a sharp drop in resistance to crack propagation after a 15-day immersion in water while the 30-day immersed samples exhibit stiffening that matches that of the dry control

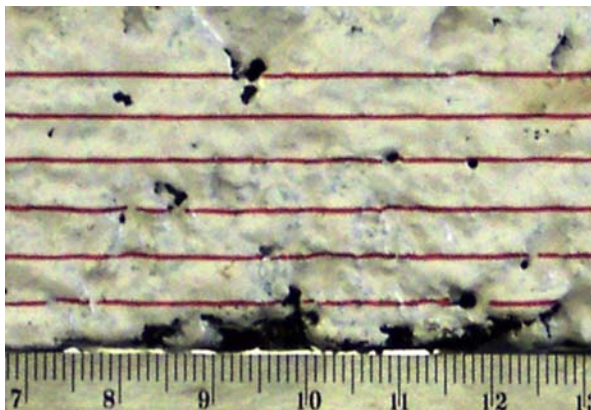

Figure 19.8 A painted ACB reinforced with JAO.

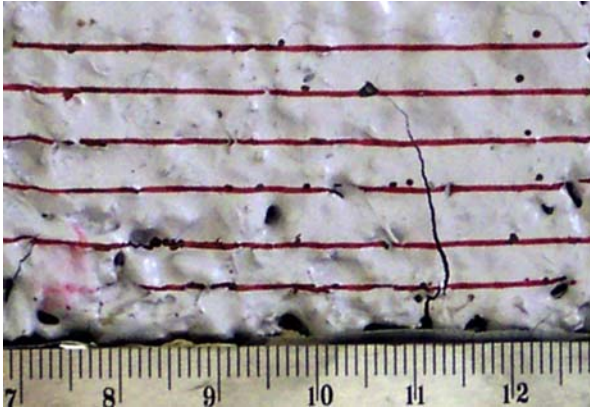

Figure 19.9 Crack propagation in an unreinforced ACB.

sample. The JAO reinforced ACBs show the best results indicating no development of crack whatsoever, both after 15- and 30-day immersion.

From the results of the experiments it was concluded that ACBs reinforced by a JAO perform satisfactorily in preventing crack propagation. Evidently the openings in JAO permit the aggregate particles from the overlay to pass through and enter suitable voids in the damaged aggregates layer below the fabric. On solidifying, these particles bridge the two layers of aggregate across the fabric permitting the entire beam to behave as a continuum. Moreover such linkages across the fabric enable a better utilization of fabric strength during distortion. In the process of passing through the grid openings, some of the strands of A/O fabric do get damaged or are pushed apart. Nonetheless, the remaining load bearing strands contribute significantly to the overall strength of the beam as evidenced by lack of any crack growth observed from the experiments conducted.

It is thus necessary to design a JAO in keeping with the particle size of the aggregate of the overlay so that wherever possible the particles of larger size can pass easily through the openings of the grid and from a bridge with the cracked layer below, without causing significant damage to the fabric. Hence the pore size of JAO should be chosen in keeping with the larger particles of the aggregate (Ghosh et al., 2010).

19.6.4 The super absorbent coir mat (Coirsorb)

Coir fibre can absorb 1.3 times its own weight of water (Satyanarayana et al., 1982). A mat of coir fibres, prepared by needle punching process, exhibits considerable amount of inter-fibre void, which is very useful in permitting growth of plant root. Indoor potted plants in cold climatic conditions are commonly grown on a bed of such mats. If a suitable absorbent fills up this void even partly, water retention capacity of the composite can increase considerably. Such a super absorbent coir mat would not only enable easier maintenance of indoor plants but may also be employed for plant cultivation in dry and arid climatic conditions where scarce water, from rainfall and

other sources, would be retained by the mat that has been laid under the soil for releasing water to the root slowly. Thereby it is important to choose the absorbent in such a way that both the substance and the process of its application to the coir mat should be eco-friendly and relatively cheap so as not to detract from some of the basic appeals of the coir fibre. Accordingly, a powdery water-soluble material was chosen (Bisen, 1998) and after a few trials, a semi-dry process was developed. This process involves spraying the surface of a thin coir mat with water and then sprinkling a definite amount of the powder evenly over the entire surface. This sequence of water spraying and powder sprinkling is to be repeated a certain number of times for achieving the desired add-on. Subsequently, another thin layer of coir mat is to be subjected to one cycle of spraying with water and sprinkling with powder. The treated surfaces of the two mats are then joined face to face and the resultant sandwich is cured in an oven. The curing process results in a cross-linking amongst the wet powdery particles and between these particles and the coir fibres. The time and the temperature of curing have to be balanced against the desired extent of cross-linking and the required absorbency. To this end the cured product – termed as Coirsorb – was tested for water absorbency as per the ASTM method D1117-74. A sample of the cured material was placed on a wire screen and both were kept immersed in water for 10 min. After the stipulated period, the screen along with the sample was taken out of water and allowed to drain for a further period of 10 min. From the weight of sample before immersion and after complete draining out, the percentage absorbency was calculated on the basis of the dry weight of the Coirsorb. As an extension of this standard test method, the wet sample was dried in oven for removing the water completely and the weight of the dried sample was measured. The difference between the weight of the parent sample, consisting of the coir mat and the powder, and that of the dried sample indicates the loss of the absorbent powder in water. This loss is an indirect measure of the extent of cross-linking; greater the cross-linking, less would be the loss of absorbent in water. The absorbency test was repeated for the dried sample and the percentage absorbency was worked out. These cycles of testing and drying were repeated a few times and it was observed that in spite of some loss of the absorbent, the absorbency of the mat keeps on increasing up to the third cycle after which it remains more or less constant.

An experimental plan was drawn up to produce different samples of Coirsorb with different time and temperature of curing. These samples were tested for absorbency as per the modified ASTM test method described earlier. The test results show that an increase in temperature or time of curing results in a higher degree of cross-linking and a drop in absorbency. The absorbency can also be varied by changing the percentage add-on of the absorbent material to the coir mat. Thus, a case exists for optimizing the percentage add-on, time of curing and the temperature of curing for minimizing the cost of the Coirsorb.

A typical value of absorbency of the Coirsorb for a 20% add-on of the absorbent can be about 400%. Such a product would, however, be about 10 times more expensive than the fibre itself. This aspect was improved upon by using coir pith, which absorbs four times its own weight of water but is a waste material and costs next to nothing. A modified Coirsorb was accordingly developed employing coir

fibre — coir pith — absorbent combination. For this purpose, a suitable paste of graded coir pith (410 μ and finer) and the absorbent was applied on both sides of coir felt. Two more pieces of felt were coated with this paste on one side only. Keeping the double-side-coated coir felt at the centre and the single-side-coated ones on its top and bottom resulted in a sandwich having the two untreated sides exposed to the outside. This ensures that the paste material is trapped inside. This sandwich on curing yielded results shown in Table 19.6. It is observed that as against 400% absorbency for a 20% add-on of the absorbent in a Coirsorb without coir pith, the modified Coirsorb with coir pith shows much higher values of absorbency with considerably lower add-on of the expensive absorbent. The significant contribution of the coir pith in enhancing absorbency of the product is clearly evident.

To test the efficacy as also the compatibility of the Coirsorb with plant root, a young plant was potted in a bed of Coirsorb with some organic manure while a similar one was potted in normal soil as a control. A regular watering schedule was maintained for both. The comparative root growth in a soil medium (on the left) and in Coirsorb (on right) is illustrated in Fig. 19.10.

19.6.5 Braided jute sapling bag

Nursery sapling bags enjoy considerable market demand and the corresponding commercial polymeric sapling bags —henceforth termed as polybags — being non-biodegradable in nature, pose serious environmental threat after saplings have been transplanted in field and the bags discarded. Equivalent bags made from jute should however pose no such problem and indeed can even be planted in field along with the saplings for providing nutrition to soil during their natural process of degradation. Moreover during the period of nurturing of saplings in nurseries, jute sapling bags can be expected to provide superior microclimate for the plant roots.

Sapling bags being tubular in nature and braiding being a one step process for conversion of yarns and tapes into tubular products, a method was developed at the Indian Jute Research Association, Kolkata for production of braided jute sapling bags of dimensions 230 mm (length) x 130 mm (folded width) and mass of about 40g with a very high cover factor. In order to achieve dimensional stability as well as high cover, a tri-axial braiding process was adopted whereby mildly sized and flattened jute slivers were employed as axial component. The axially oriented flat tape-like slivers did not take part in the braiding process but only got entrapped in the braided structure thus remaining perfectly aligned along the braid axis imparting a degree of

Table 19.6 Effect of coir pith on absorbency of Coirsorb.

Specifics	Sample 1	Sample 2
% Absorbent add-on on the weight of coir and pith	7.6	9.4
% Pith add-on on the weight of coir	22.5	52.5
% Absorption of water on the total weight of sandwich	496.5	618.0



Figure 19.10 Comparative root growth in soil (left) and in Coirsorb (right).

rigidity and the desired cover to the product. It may be noted that sapling bags are not as such subjected to any substantial mechanical strain during their functional stages and hence the role of the sapling bag is simply protective in nature i.e. preventing soil loss and ensuring a moist and conducive environment for root growth. Clearly, flattened slivers by their very nature should provide good cover and retain moisture in their inter-fibre spaces.

During braiding, the sliver tapes got false-twisted due to oppositely moving/crossing braiding yarns before getting embedded into the braided structure, collapsing thereby into elliptical/rounded cross-sections. This resulted in loss of cover and reduction in product width. To mitigate this problem, flexible plastic pipe guides were employed to guide the jute tapes up to the braiding point. In this way, samples of jute braided sleeves of adequate cover and width were prepared employing jute tapes of different fineness and widths and varying number of braiding yarns per spindle. A typical structure of such a sleeve is shown in [Fig. 19.11](#).



Figure 19.11 Structure of the sleeve fabric.

The braided tubes were cut into pieces of specific length and the individual pieces were then converted into sapling bags by doubling the sleeves in a specific manner and closing one end suitably. Actual view of this product and of one such bag containing a sapling is shown in Figs. 19.12 and 19.13 respectively. Actual field tests of these bags were carried out for evaluating their performance in respect of growth of saplings in nursery and their effect on soil after transplantation in field.

Quality assessment of nursery seedlings is based upon morphological traits and physiological traits of seedlings (Ferdousee et al., 2010; Haase, 2008; Trubat et al., 2010; Villar-Salvador et al., 2004). In addition to this, a seedling's morphological characteristics can be considered to be a physical manifestation of its physiological activities whereas physiological quality depends on the seedling's internal functions. Morphological traits are more easily measured than physiological traits. Consequently, performance evaluation of this agrotexile product was carried out with the help of some typical morphological traits of the seedlings, viz., stem base diameter (SBD), stem height (SH), root volume and length, etc. A commercial polybag was used as the control.

To investigate the effect of biodegraded jute sapling bag on nutrient level of soil, a soil analysis test was carried out on parent soil samples as also on soil samples collected after 55 days of transplantation in field of saplings in jute sapling bags for determining nitrogen, phosphorous (P_2O_5), potassium (K_2O) and organic carbon (%) contents.

The results of growth in SBD and of SH of Sunflower seedlings in jute and polybags revealed statistically similar trends. Visual observations revealed however the emergence of a root network through jute braided sapling bags, while not a single root was able to come out through the holes punched in polybags. Moreover from



Figure 19.12 A sapling bag.



Figure 19.13 Sapling in a sapling bag.

results of soil analysis tests listed in [Table 19.7](#) it is observed that decayed jute bag contributes to a statistically significant rise in organic carbon, phosphorous and potassium content in soil.

It can thus be concluded that as opposed to polybags, the jute braided sapling bags allow a healthy growth of root network of nursery saplings while after being transplanted in soil along with the saplings, the biodegradation of jute bags leads to a significant enhancement of soil-nutrient. Hence purely from the environmental aspect, jute braided sapling bags should be preferred to eco-hazardous polybags.

19.6.6 Transportable natural grass lawn (COCOLAWN)

Artificial grass lawns find applications in residential gardens, balconies, roof tops, urban spaces, playgrounds, office interiors etc. They come in roll forms, can be transported and require minimal maintenance after installation. Such products are manufactured from Nylon or Polypropylene fibres of suitable composition, cross section and colour that are spun into yarns and tufted onto suitable primary backing fabrics

Table 19.7 Results of soil analysis.

Sample type	pH	Organic carbon (%)	N (kg/ha)	P ₂ O ₅ (kg/ha)	K ₂ O (kg/ha)
Parent soil	7.67	0.78	384.0	66.3	163.8
Soil containing degraded jute sapling bag	7.53	1.48	361.0	118.5	371.6

made from materials as diverse as polyester tire cords to jute yarns. A coating of latex or polyester foam is applied to the exposed side of the backing fabric before pasting the secondary backing fabric and curing the entire assembly. Artificial turf surface is however less friendly to human body than natural grass and thus wherever body contact is an issue the latter would be preferred provided that a portable natural grass material is easily available.

COCOLAWN, developed by the Central Coir Research Institute (CCRI) of the Indian Coir Board is a transportable natural grass lawn. It is manufactured by creating a substrate from a single or double layer of coir needled felt supported by a layer of coir netting which is then topped up with a bed of coir pith. Grass slips are then planted in this bed and the organic manure C-POM, also developed by the CCRI is sprinkled on top for promoting growth of grass. C-POM results out of bio-conversion of coir pith by suitable fungi that produce enzymes which in turn break down the lignocelluloses of coir pith. C-POM has higher Nitrogen, Potassium and Phosphorous content than coir pith and has much lower particle size that lowers its volume by nearly 50%. The bushy under layer of coir felt substrate and the congenial microclimate of coir pith bed aided by a regular sprinkling of water permits the grass roots a healthy growth and a firm anchorage so that within a period of about 3 months a stable lush green grass lawn is established. COCOLAWN comes in the form a blanket and can be rolled up and transported directly to the site.

As opposed to artificial turf, the layer of grass on COCOLAWN requires regular watering along with sunlight for its survival. Moreover as the grass grows it would need to be cropped from time to time. Similarly maintaining a COCOLAWN blanket in a rolled up condition for an extended period of time, either during transportation or storage, would damage or even destroy the grass layer. It is however quite conceivable to develop the entire COCOLAWN layer in situ by transporting the raw materials, namely coir netting, coir felt, coir pith and C-POM and developing the lawn with the help of locally resourced grass slips.

19.6.7 Waterproof jute packaging (natural rubber coated jute, NRcJ)

Jute is biodegradable but jute fabric is often laminated with low-density polyethylene (LDPE)/polypropylene (PP) for shopping/carry bag application. The resultant product is only partially biodegradable. Moreover this material cannot be cleaned by normal washing process. It was therefore decided to employ natural rubber (NR) for creation of new packaging material(s) (Natural Rubber coated Jute or NRcJ) mainly for washable jute shopping/carry bags which being totally biodegradable would pose no environmental problems of disposal. Accordingly a fine Hessian grey jute fabric of areal density 258 g/m² and thickness 0.9 mm was coated with a suitable rubber compound by employing the calendaring technique. The basic process of calendaring is illustrated in the following flow diagram while a simple three bowl calendar is illustrated in [Fig. 19.14](#).

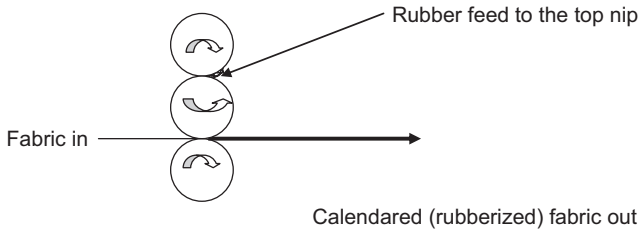
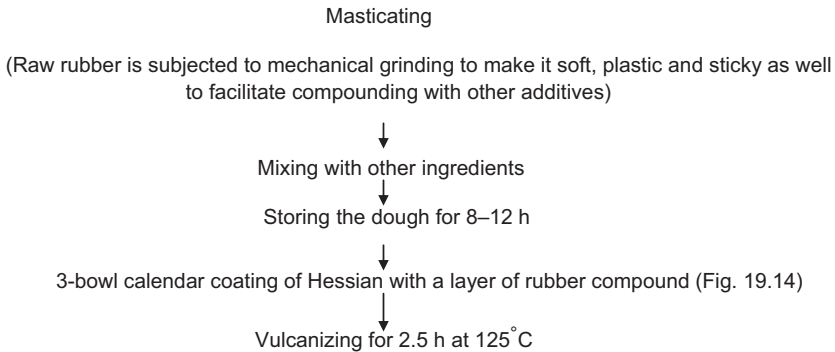

Figure 19.14 Three bowl calendaring.



It was decided to evaluate the following physical properties of the grey fabric and the product.

- Areal density in g/m^2 ;
- Tensile behaviour in warp, weft and bias directions;
- Flexural rigidity: warp way, weft way as also overall;
- Peel strength of coated layer;
- Seam stretchability and seam strength;
- Resistance to mild abrasion.

The response of the coated surface of the fabric to water was also evaluated by the following tests.

- Water permeability under hydrostatic head;
- Grade of water repellency under standard shower;
- Water absorbency and water penetration;
- Appearance of washed samples.

A comparative evaluation of relevant physical properties as also of cost of the coated product and of a commercial laminated product was carried out. The following conclusions were drawn from this exercise.

1. With approximately 130 g of coating material per square metre of fabric the strength of the coated fabric went up in the length (10%) and bias directions (40%) while a drop of 20% was encountered in the cross direction. The drop in strength in the cross direction was found

to be primarily owing to skewing of the fabric during calendaring process. A more controlled calendaring should yield better strength.

2. The coating process resulted in a flexural rigidity increase of approximately 50% over the grey fabric. Lamination with PP or PE leads however to a 250% rise in rigidity. Evidently the rise in flexural rigidity on coating with rubber is primarily due to reduction in mobility of threads. The coat of rubber compound is very soft and does not contribute significantly to the overall rigidity.
3. The abrasion resistance of the rubber layer is far superior to that of the jute fabric. Hence the coating can be viewed to be durable in so far as abrasion behaviour of the product is concerned.
4. The coating adheres to jute fabric very strongly. In fact the adhesion strength is nearly 3 times higher than that of the PP/PE lamination.
5. Sewing the coated fabric poses no special problem. In fact the seam strength in both directions was found to be superior to that of the grey fabric.
6. The water permeability test (Hydrostatic head test) revealed that the PP/PE lamination is about 2.6 times less permeable than the coating generated by the current recipe.
7. The Bundesmann shower test revealed that after 5 min of shower on the coated side, the fabric picks up about 90% of its own weight of moisture. However, the amount of water that actually penetrated through to the unexposed side was negligible. In fact the laminated fabric also gets thoroughly wet on spraying but allows hardly any water to actually penetrate. In this sense the fabric coated with NR compound behaves very similar to the laminated one.
8. The washed samples (taken from shower of Bundesmann apparatus) did not reveal any distortion after drying. The surface smoothness of the dried sample could be restored by light ironing. In this sense the rubber coated jute fabric is washable, which is not the case for the laminated ones.
9. The printing quality of the exposed side of the jute fabric does not get affected by the rubber coating of the reverse side.
10. The cost of coating jute Hessian with 130 g/m² of rubber compound compares favourably with the cost of lamination with PP/PE film.

From the observations listed in the foregoing one can conclude that from the point of view of the end use, the jute Hessian fabric coated with a suitable rubber compound by the process of calendaring (NRCJ) yields a product that has comparable, and in some respects even superior properties to that of the PP/PE laminated material used widely in shopping/carry bag applications. The absolute eco-friendliness of the product as also its washability on soiling renders additional dimensions of global appeal to NRCJ.

19.7 Market potential of jute-coir environmental textiles

The global scenario in respect of cultivation, production and trading of jute and coir fibres, yarns and fabrics are adequately covered by [Arancon \(2008\)](#), [FAOSTAT \(2018\)](#) and [Rahman \(2008\)](#). Over the recent past an element of stagnation in all respects is discernible be it in terms of volume of fibres produced annually or in the

area under cultivation or the type of products traded commercially. The intervention of Government agencies in providing minimum support prices, in legislating mandatory use of some of the products in certain segments of the economy or in providing marketing support offers some relief to the concerned agriculture and industry. It has also been suggested that these natural resources could find alternative use as hard wood, providing feedstock to the paper and pulp industry. However it is the opinion of the author that a qualitative breakthrough in extraction of fibre followed by suitable grading based on technical parameters and an upgraded spinning system that would yield good and consistent quality of finer and stronger yarns is the key to a transformation of the related industries. If there is an international effort at protecting and promoting these EFGs, innovations in process (such as improved retting) and in products (such as lighter and denser packaging material) may follow. A large number of very useful green products can then be developed from finer, stronger and uniform jute and coir yarns which by their own merit would appeal to the global consumer, without needing any props from outside agencies. The high share of freight, a major constraint to the concerned trade would also get addressed simultaneously. Viewed in the light of current global concern of widespread pollution arising out of use of plastics, promotion of innovative development of products of daily necessities from renewable and biodegradable materials such as jute and coir fibres has become imperative for the very sustenance of life on earth.

19.8 Conclusion

Jute, a bast fibre, and coir, a seed husk fibre, exhibit many similarities (Section 19.2) while being complementary in terms of certain properties such as tensile modulus, percentage elongation at break (Table 19.4) etc. Because of their unique physical and chemical properties, these two fibres can be used either alone (19.6.3, 19.6.5) or in blends (19.6.1, 19.6.2) or even in association with other eco-friendly materials (19.6.4, 19.6.6, and 19.6.7) for developing technical textile products satisfying widely varying functional requirements. Production processes of the illustrated geo-, agro-, horticultural and packaging textiles satisfy demands of EFGs to a great extent with the fibre extraction retting process posing the sole cause of some concern. Indeed with growing awareness of the extensive long term ecological damage being caused by synthetic fibres, the issue of appropriate extraction process of all types of natural fibres, including jute and coir need serious global attention. A concerted single agenda focus on this issue would not only lead to a lowering of ecological impact but also to availability of a range of superior quality fibres which in turn would lead to a wider palette of textile products made from natural fibres thereby lessening global dependence on synthetic fibres. Development of such EFGs would also be in consonance with the concept of promoting and nurturing sustainable natural capital.

List of abbreviations

AC	Asphalt concrete
ACB	Asphalt concrete beam
A/O	Asphalt overlay
APEC	Asia Pacific economic cooperation
EG	Environmental goods
EGS	Environmental goods and services
EFG	Environmentally friendly goods
FAO	Food and Agriculture organization of the United Nations
JAO	Jute-asphalt overlay fabric
LCA	Life cycle analysis
MTS	Material testing system
NR	Natural rubber
NRcJ	Natural rubber coated jute
OECD	Organization for economic cooperation and development
PsECB	Pre-seeded erosion control blanket
PVD	Prefabricated vertical drain

References

- Akagi, T., 1994. Hydraulic applications of Geosynthetics to filtration and drainage problems — with special reference to prefabricated band-shaped drains. In: Keynote Address Presented at the Fifth International Conference on Geotextiles, Geomembranes and Related Products. Singapore.
- Anon, 2002a. Life Cycle Analysis of PP-HDPE Woven Sacks vis-à-vis Jute/Paper Sacks in Terms of Environmental Studies. Study Report of IIT Delhi. India.
- Anon, 2002b. Comparative Study of Jute and Polypropylene in Respect of Their Relative Costs and Advantages. Study Report of IIT Kharagpur. India.
- Anon, 2010. Study Report on Prices of Coconut Crop: Agriculture Market Intelligence Cell. Kerala Agricultural University, India.
- Arancon, R., 2008. Coir in Asia and Pacific. In: Proceedings of the Symposium on Natural Fibres. Rome.
- Banerjee, P.K., 2001. Development of textile products for protection and enhancement of environment. *Indian J. Fiber Text. Res.* 26, 214–222.
- Banerjee, P.K., 2003. The Relevance of Jute and Coir Products as Environmental Goods. Expert Meeting on Definitions and Dimensions of Goods and Services in Trade and Development. UNCTAD, Geneva.
- Banerjee, P.K., Chattopadhyay, R., Guha, A., 2002. Investigations into homogeneity of coir fibres. *Indian J. Fiber Text. Res.* 27, 111–116.
- Banerjee, P.K., Ghosh, M., 2008. Studies on jute-asphalt composites. *J. Appl. Polym. Sci.* 109, 3165–3172.

- Banerjee, P.K., Sampath Kumar, J.P., Rao, G.V., 2000. Production methods and characteristics of braided PVD. *Indian J. Fiber Text. Res.* 25, 182–194.
- Banerjee, P.K., Unni, E.B., 1997. Growth prospects of natural geotextiles. In: *Book of Papers of Geosynthetics Asia Conference*, pp. A169–A182. Bangalore.
- Baron, R.A., 1948. Consolidation of fine grained soils by drain wells. *Trans. ASCE* 2346, 718–754.
- Bisen, V.K., 1998. Increasing the Absorbency of Coir Felt. M.Tech Thesis. Indian Institute of Technology, Delhi.
- Braungart, M., Engelfield, J., Hansen, K., Mulhall, D., Neumann, M., 1992. Environment Protection Encouragement Agency Report. Hamburg. Germany.
- Brown, S.F., Thom, N.H., Sanders, P.J., 2001. A study of grid reinforced asphalt to combat reflection cracking. *J. Assoc. Asphalt Paving Technol.* 70, 543–570.
- Chen, R.H., Chen, C.N., 1986. Permeability Characteristics of Prefabricated Vertical Drains. Paper Presented at the Third International Conference on Geotextiles. Vienna, Austria.
- Dempsey, B.J., 2002. Development and performance of interlayer stress-absorbing composite in asphalt concrete overlays. *Transp. Res. Rec.* 1809, 175–183.
- FAOSTAT, 2018. <http://www.fao.org/faostat/en/#data/QC>.
- Ferdousee, N., Jabbar, F., Hossain, M.K., Rafiqul Hoque, A.T.M., 2010. Comparative Growth performance of *Leucocephala* seedlings raised in nursery bed, polybag and root trainers. In: *Proceedings of International Conference on Environmental Aspects of Bangladesh (ICEAB10)*. Japan, pp. 65–68.
- Fernandez, C., 2003. Strategic Alliance for the Development of Coir Industry in the APCC Countries and Demand Prospects for Coir Products in Ecofriendly Applications. <http://coirboard.gov.in/wp-content/uploads/2014/07/article1.pdf>.
- Ghosh, M., Banerjee, P.K., Rao, G.V., 2010. Development of asphalt overlay fabric from jute. *J. Text. Inst.* 101, 431–442.
- Groenewegen, P., Van Overbeeke, G., 1994. *Jute and Life Cycle Analysis*. Vrije University, Netherlands.
- Guha, A., 1995. *Studies on Physical Properties of Coir Fibres and its Compatibility with Jute*. Indian Institute of Technology, Delhi, India. M. Tech Thesis.
- Hansbo, S., 1979. Consolidation of clay by band shaped prefabricated drains. *Gr. Eng.* 12 (5), 16–25.
- Hansbo, S., 1983. How to evaluate the properties of prefabricated drains. Paper Presented at the Eighth European Conference on Soil Mechanics and Foundation Engineering. Helsinki, Finland.
- Haase, D.L., 2008. Understanding forest seedling quality: measurements and Interpretation. *Tree Planters' Notes* 52 (2), 24–30.
- Holtz, R.D., Christopher, B.R., 1987. Characteristics of prefabricated drains for accelerating consolidation. In: Paper Presented at the Ninth European Conference on Soil Mechanics and Foundation Engineering. Dublin, Ireland.
- Ingold, T.S., 1994. The mechanics of erosion control. In: Paper Presented at the Second International Workshop on Geotextiles. New Delhi, India.
- Jayachandran, K., Dutta, U., 1997. Development & promotion of jute geotextiles. In: Paper Presented at the National Workshop on Jute Geotextiles. Calcutta, India.
- Khanna, P., 2003. Are Environmental Goods and Services Different from (Manufacturing) Goods and Services. Seminar on “Trade Liberalization in Environmental Goods and Services”. New Delhi, India.
- Koerner, R.M., 1990. *Designing with Geosynthetics*, fourth ed. Prentice-Hall, New Jersey.

- Lytton, R.L., 1989. Use of geotextiles for reinforcement and strain relief in asphalt concrete. *Geotext. Geomembr.* 8, 217–237.
- Oostveen, J.P., Troost, G.H., 1990. Discharge index tests on vertical drains. In: Paper Presented at the Fourth International Conference on Geotextiles, Geomembranes and Related Products. Rotterdam, Netherlands.
- Oosthuizen, P., Kruger, B., 1994. The use of sisal fibre as natural geotextile to erosion control. In: Paper Presented at the Fifth International Conference on Geotextiles, Geomembranes and Related Products. Singapore.
- Prabhu, G.N., 1956. Technological research on coir. *Coir* 1, 17–20.
- Rahman, A.K.M.R., 2008. Jute in south Asia. In: Proceedings of the Symposium on Natural Fibres. Rome.
- Rahman, S., Kazal, M.M.H., Begum, I.A., Alam, M.J., 2017. Exploring the future potential of jute in Bangladesh. *Agriculture* 7 (12), 96.
- Rathmayer, H., Komulanein, H., 1992. Quality Requirements of Prefabricated Strip Drains. Finn Road Administration Report No.22/92. Helsinki, Finland.
- Rawes, B.C., 1997. Critical parameters for specification of prefabricated vertical drains. *Geosynth. Int.* 4 (1), 51–64.
- Rickson, R., Loveday, A.D., 1996. Technical Specification & Market Study on Potentially Important Jute-Geotextile Products. Techno-Economic Manual Presented at IJO Workshop. Dhaka, Bangladesh.
- Rowell, R.M., Stout, H.P., 1998. Jute and Kenaf. In: Lewin, M., Pearce, E.M. (Eds.), *Handbook of Fiber Chemistry*, second ed, vol. 4. Marcel Dekker, New York, pp. 466–471.
- Satyanarayana, K.G., Pillai, C.K.S., Sukumaran, K., Pillai, S.G.K., 1982. Structure property studies of fibres from various parts of the coconut tree. *J. Mater. Sci.* 17, 2453–2462.
- Singh, S., 2003. Trade Liberalization in Environmental Goods. Seminar on Trade Liberalization in Environmental Goods and Services. New Delhi, India.
- Trubat, R., Cortina, J., Vilagrosa, A., 2010. Nursery fertilization affects seedling traits but not field performance. *J. Arid Environ.* 74, 491–497.
- Villar-Salvador, P., Planelles, R., Enriquez, J., Rubira, J.P., 2004. Nursery cultivation regimes, plant functional attributes and field performance relationships in the Mediterranean. *For. Ecol. Manag.* 196, 257–266.

This page intentionally left blank

Judit Borsa

Óbuda University, Budapest, Hungary

20.1 Introduction to textiles and microbial hazards: past and present

Textile/microbe relation can be interesting in two areas: deterioration of fibres caused by microbes and textiles as carriers of microorganisms. The latter one has recently got special interest both in medical applications and in everyday life.

20.1.1 *Biodeterioration of natural fibres*

During World War II, cotton fabrics were used extensively for military functions such as tents, etc., and so these fabrics needed protection from rotting. Military fabrics were treated with mixtures of chlorinated waxes, copper and antimony salts, which stiffened the fabrics and gave them a peculiar odour. At that time, pollution and toxicity were not major considerations ([Fibre2fashion, 2010](#)). Nowadays, some outdoor textiles still need antimicrobial finishing.

20.1.2 *Infectious diseases*

The role of clothes in protection against infection and in the spread of bubonic plague was recognized in the middle ages. Physicians wore long dark robes, and the clothes of victims were burned. The relationship between textiles and disease was scientifically proven by the British surgeon Lister, who impregnated bandages with carbolic acid (phenol; [Lister, 1867](#)). He was influenced by the Hungarian physician Semmelweis, the ‘saviour of mothers’, who significantly reduced the mortality of women from puerperal sepsis: he ordered doctors to wash their hands in chlorinated lime (calcium hypochlorite) solution in 1847 and published his results in a book in 1861. After 150 years, it is still necessary to call attention to the importance of hand washing ([Cooper et al., 1999](#); [Curtis, 2008](#); [Hilburn et al., 2003](#); [Jensen et al., 2006](#); [Kampf, 2004](#); [Kampf and Kramer, 2004](#); [Larson and Aiello, 2006](#); [Parvez and Jarvis, 1999](#); [Pittet et al., 2000](#); [Rosenthal et al., 2005](#); [Silvestri et al., 2001](#); [Toshima et al., 2001](#); [Vandenbroucke-Grauls, 2000](#)), as transmission of microorganisms during hospital care occurs most commonly via the hands of personnel ([Struelens et al., 2004](#)) and less commonly by contaminated equipment. The discovery of the contaminated environment’s role increased the demand for antimicrobial medical tools and fabrics.

20.1.3 Everyday products

Antimicrobial fabrics can be used in air filters, cars and for home furnishings. Consumers' attitude towards hygiene and active lifestyles has created a new market for antimicrobial textiles (Gao and Cranston, 2008). Advertising and the media are criticized for reinforcing this desire and for ignoring the fact that bacteria are part of life. According to critical voices, antimicrobial materials, and textiles in particular, have not been developed as a substitute for personal physical hygiene (Girrbach, 2003).

This chapter discusses the role of textiles, mostly cotton, in infection control in hospitals and the manufacturing issues of their production. The most important function of antimicrobial textiles is protecting susceptible immunocompromised patients and sensitive newborns. Antimicrobial textiles for wastewater contamination have also been recently investigated; results in this field can be used in everyday life (e.g., odour control).

20.2 Survival of microbes on fabric surfaces

Microbes have their special strategy to survive on any surface. Fibre properties influencing microbes' adherence are not yet completely understood. Survival time has a high diversity determined by many parameters.

20.2.1 Microorganisms on surfaces in general: biofilms

Bacterial cells are usually investigated in their planktonic (free-swimming) phase, although the growth of bacteria in nature occurs in associations. When a community of microorganisms irreversibly attaches itself to a surface, it produces extracellular polymeric substances called biofilms. Biofilms are highly hydrated and chemically complex matrices that serve as storage facilities for nutrients, and which can entrap other microbes and noncellular materials (Lindsay and von Holy, 2006; Vigo, 1994, pp. 225–43). Porous materials with rough surfaces entrap more bacteria compared with those with smoother surfaces (Gough and Dodd, 1998); roughness of the surface decreases the efficacy of the biofilm cells' inactivation (Korber et al., 1997). Biofilms are developed by bacteria as well as other microorganisms (Saarela et al., 2004). The duration of cell attachment to surfaces is between a few minutes and several hours (Meyer, 2003). Biofilms are richer in nutrients than the environment (bulk fluid; Webb et al., 2003), and the bacteria in biofilms are more resistant to various antimicrobial chemicals, including antibiotics, metals and ultraviolet (UV) light, than the corresponding planktonic cells (Lindsay and von Holy, 2006; Vigo, 1994, pp 225–30). Resistance of clinical isolates of *Staphylococcus aureus* and *Pseudomonas aeruginosa* to a nonantibiotic antimicrobial agent was found to be 1000-fold higher in the biofilm state compared with the planktonic (Gorman et al., 2001). The development of biofilms can be prevented by applying antimicrobial agents to textile surfaces.

20.2.2 Adherence of microorganisms to fibres

Colloidal chemical theories such as the DLVO theory (Derjaguin–Landau–Verwey–Overbeek theory of colloidal stability) can be used to explain bacterial adhesion. The DLVO theory describes the net interaction between a cell and a flat surface (substratum) as a balance between two additive factors: attraction resulting from van der Waals' forces and repulsion from the overlap between the electrical double layer of the cell and the substratum (Chu et al., 2009; van Loosdrecht et al., 1990; Vigo, 1994, p. 228). The adherence of bioluminescent *Escherichia coli* to various fibres was determined by the luminescence of the fibres. Calculations using adherence values and surface charges of the bacteria and fibres suggested that *E. coli* does not behave according to the DLVO theory. This was attributed to the fact that the bacteria do not have a homogeneous surface structure, and local zeta potentials of various parts of the bacteria can differ from the overall zeta potential measured. It was also assumed that other forces were in effect besides van der Waals' and repulsive interactions. The order of the bacteria adsorption capacities of fibres was viscose >>> cotton > silk > polyester. Authors pointed out that the results followed the same trend as the hydrophilicity of the fibre, suggesting that the more hydrophilic the fibre, the more cells it could immobilize (Chu et al., 2009). Other authors found similar correlations (Vigo, 1994, p. 230). It is worth mentioning that viscose adsorbed about four times more bacteria than cotton did, while the difference in hydrophilicity of these fibres is far less; hydrophilic character of fibres might be an important factor, but other properties must also contribute. Takashima et al. (2004) soaked various fibres in bacteria (*S. aureus*, *P. aeruginosa*) suspensions for a set time and calculated the bacteria-binding property of fibres from colony-forming units remaining in the suspension. 1%–2% of bacteria were adsorbed on cotton and nylon, and values for wool varied between 34% and 93% depending on the strains (average 63%), while polyester and polyacrylonitrile picked up about 90% of the microbes in suspension. Comparing these results (Takashima et al., 2004) with the previous ones (Chu et al., 2009), we can see a serious discrepancy, for example, the order of bacteria binding ability was cotton > polyester (4.5-fold; Chu et al., 2009) and polyester >> cotton (45-fold!) (Takashima et al., 2004), respectively. As far as the role of a substrate's hydrophilic character is concerned, contradictory results for bacteria adherence were found on surfaces other than fibres as well (Merritt and An, 2000, p. 62). Highly swellable cellulose derivative fibres, used for wound healing, sequester and immobilise the pathogenic microorganism. This property may help support wound healing (Newman et al., 2006).

20.2.3 Survival time: diversity

Recently, a highly sensitive, rapid and specific method has been developed for the detection and characterization of microbial or viral deoxyribonucleic acid (DNA) and ribonucleic acid. Microbiology laboratories can therefore be more effective in investigating and controlling healthcare-associated infections. The majority of nosocomial infections are caused by commensal bacteria such as *E. coli* and *S. aureus*, but

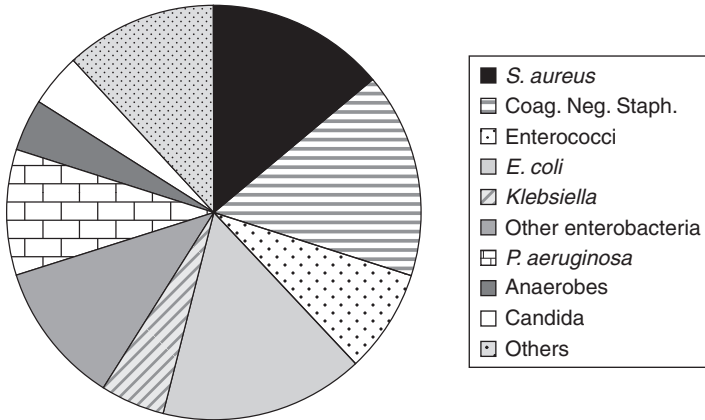

Figure 20.1 Microorganisms causing nosocomial bacteraemia, Erasme Hospital, Brussels, Belgium, 2002 (Struelens et al., 2004).

many other microorganisms also exist in hospitals (see Fig. 20.1; Struelens et al., 2004). Bacteria differ in their ability to survive in the hospital environment outside the human host. The persistence time of microbes depends on the mode of contamination and relative humidity. Aerosol contamination by *S. aureus* and polio virus of fabrics subsequently held at low humidity was the most conducive for survival of the microbes, whereas contamination of fabrics in solution subsequently held at high humidity led to the shortest survival time (Vigo, 1994, p. 230). Additionally, the importance of temperature, humidity and pH in the development of microorganisms is well known in the area of biodeterioration of textiles (Szostak-Kotowa, 2004). Isolates of 22 Gram-positive bacteria on 5 common hospital materials, mostly textiles, survived for at least 1 day, and some survived for more than 90 days (Neely and Maley, 2000). Vancomycin-resistant enterococci are able to survive on various surfaces including carpet and upholstery for at least 7 days, and this could promote cross-transmission to hands touching the contaminated surface (Lankford et al., 2006). Study of different kinds of bacteria strains showed a large variation in survival among the various species (medians are between 1 day, 5 days and >60 days) and among the individual strains of the same species as well (e.g., 15 methicillin-sensitive *S. aureus* strains – median: 12 days, range: 1 to > 60 days; Gastmeier et al., 2006).

20.3 Textiles as protection against biohazards and as infection reservoirs

Clothes have dual role regarding microbes. They protect against infection entrapping the contamination while adhered microorganisms can leave the fabric and cause new infections. Antimicrobial textiles have been developed to minimize this disadvantageous effect.

20.3.1 Protection against biohazards

The barrier effect of clothing is a key factor in protection against infection in many working environments, especially in hospitals. Bacteria are transported by carriers (vehicles) such as fluids or dust (air), hence limiting or even preventing vehicles' transfer provides indirect protection against microbes. The types and characteristics of gowns and other products depend on the task and degree of exposure anticipated. Fluid-resistant or even fluid-impermeable breathable fabrics are available, mostly for use in operating theatres.

Fabric characteristics (fibre type, construction, repellency, porosity) have important roles in barrier effectiveness; smaller pore size (Aibibu et al., 2003; Leonas and Jinkins, 1997; Leonas and Jones, 2003) and higher repellency (Leonas and Jinkins, 1997) correspond with improved barrier properties. Liquid strike-through is not always accompanied by bacterial transmission (Leonas and Jinkins, 1997). Certain fabrics provide better protection against *E. coli* than against *S. aureus* due to the different sizes and shapes of the bacteria (Leonas and Jones, 2003). Repeated laundering reduces the ability of most fabrics to prevent the transmission of bacteria (Leonas, 1998). Detailed information on the protective properties of textiles against microorganisms and their tests are given by Brown (1996).

It is shocking that, according to a study, rates of gown usage by healthcare providers and staff are generally mediocre: mean gown use in rooms of patients with contact precautions was only 76% for healthcare providers and 65% for visitors (Manian and Ponzillo, 2007).

20.3.2 Infection reservoir

Contaminated textiles can be reservoirs for the dissemination of microorganisms as has been pointed out by many authors (Das et al., 2002; Larson and Aiello, 2006; Malnick et al., 2008; Towner, 2009; Trillis et al., 2008). Frequent sterilization of garments by hot methods (steam autoclave or dry heat) or by cold processes (gas or irradiation), respectively (Araujo-Marques and Cabeço-Silva, 2001; Ferreira et al., 2002), can reduce the danger. Disposable garments are considered useful in preventing contamination, but not all disposable products are effective. For example, use of paper drapes and gowns conferred no benefit over a reusable fabric in terms of postoperative wound infection (Bellchambers et al., 1999), while application of disposable gowns in an intensive care unit was associated with a 54% reduction in vancomycin-resistant enterococci (Puzniak et al., 2002). The main advantage of the nonwoven disposable fabrics is the elimination of fibre dust (Rigby and Anand, 2000, p. 422); cotton (or paper) gowns can be a source of contamination because they produce dust (lints) that can carry microorganisms (Vigo, 1994, pp. 238–9). Airborne microorganisms are very hazardous, especially in postoperative infections (Kolmos et al., 1997). Bed-making generates dust and airborne microorganisms (Shiomori et al., 2002), and microbes are emitted from thermal insulation as well (Koivula et al., 2005).

Reports on the role of textiles in the transmission of infection are convincing and hang together with simple everyday experiences. However, there is room for

significant differences of opinion. On the one hand, representatives of an antimicrobial textiles producing company, using data from many studies, assert that biocidal textiles can help fight nosocomial infections (Borkow and Gabbay, 2008). On the other hand, authors of an official report cast doubts on the experiences cited above, suggesting that 'the hypothesis that uniform/clothing could be a vehicle for the transmission of infection is not supported by existing evidence', and they suggest to wash the staffs' hospital uniform at home saying that 'there is no robust evidence of a difference in efficacy of decontamination of uniforms/clothing between industrial and domestic laundry process or that the home laundering of uniforms provides inadequate decontamination' (Wilson et al., 2007).

20.4 Antimicrobial fibres

Antimicrobial agents either inhibit the growth of (-static) or kill (-cidal) microorganisms. Almost all antimicrobial agents used in commercial textiles are biocides. The activity that affects bacteria is known as antibacterial and that which affects fungi is called antimycotic. Antimicrobial activity is characterized by the minimal inhibitory concentration determined in solution. It is necessary to consider that applying agents to fibres generally reduces their activity. Cotton is most commonly used in healthcare; there are relatively few articles on antimicrobial protein fibres.

20.4.1 Requirements for antimicrobial textiles

An ideal antimicrobial treatment of textiles should satisfy various requirements (Gao and Cranston, 2008; Purwar and Joshi, 2004; Ramachandran et al., 2004). They should selectively target undesirable microorganisms and be low hazard (manufacturing, application, environment). Durability to various cleaning and ironing processes, with no deterioration of fabric quality, is also important. Antimicrobial treatments must also be compatible with textile chemical processes, and of course be cost effective.

20.4.2 Basic mechanisms of the antimicrobial effect

Biological effect: the basic mechanisms of antimicrobial effects are summarized in a comprehensive review (Gao and Cranston, 2008). Antimicrobial agents damage cell walls or alter cell membrane permeability, denature proteins, inhibit enzyme activity or inhibit lipid synthesis, all of which are essential for cell survival.

Physicochemical effect: an antimicrobial agent either can be released from the fibre into a humid environment (diffusion) or it can be permanently fixed to the fibre. In the former case, the rate of release and the loss of activity (durability) can vary between very wide intervals depending on many parameters. The leaching agent sooner or later runs out; moreover, the process may cause health problems and environmental pollution. In the latter case, no leakage occurs (durable), and direct contact between the fibre and the microorganism is necessary to obtain antimicrobial activity.

20.4.3 Basic methods of manufacturing antimicrobial natural fibres

There are two basic methods for producing antimicrobial textile products: spinning antimicrobial fibres and treating fibres or fabrics in a finishing process.

Spinning: antimicrobial man-made fibre of natural origin can be manufactured either using inherently antimicrobial natural polymers such as chitosan, deacetylated derivative of natural chitin, the main component of marine crustaceans (see [Section 20.7](#)), or by incorporating antimicrobial agents into the fibre dope during spinning. The latter technology is mostly applied to synthetic fibres; there are many commercial antimicrobial fibres in the market ([Anon, 2005](#)). Although some of these fibres are of natural origin, this chapter deals with native fibres only.

Antimicrobial finishing: antimicrobial agents can be applied to textile substrates, mainly fabrics, by exhaust, pad-dry-cure, coating, spray and foam techniques ([Abdel-Halim et al., 2010](#); [Anon, 2005](#); [Gao and Cranston, 2008](#); [Ramachandran et al., 2004](#)). Various methods can improve durability:

- Adsorption of the active agent on the fibre (e.g., ions, small molecules, colloids, nanoparticles (NPs), development of NPs on the fibre by sol–gel method); pretreatments of the fabric for enhancement of the adsorption.
- Treating the fabric with carrier materials entrapping the antimicrobial agent (e.g., resin, zeolite, NPs, microcapsule, cyclodextrin).
- Anchoring the antimicrobial agent or its carrier to the fibre by cross-linking (e.g., chlorotriazine or silane groups containing cross-linker, chemicals of easy care finishing).
- Application of polymeric antimicrobial material as a thin surface coating.
- Development of antimicrobial groups directly on the fibre (e.g., quaternary ammonium groups by alkylation or high-energy irradiation grafting).

Various chemicals can be used for preparing antimicrobial textiles. Nowadays, silver NPs, quaternary ammonium compounds (QACs) and chitosan seem to be the most studied species. Examples of various manufacturing methods are discussed in the antimicrobial agents section.

20.4.4 Evaluation of antimicrobial efficacy

There are many test methods for evaluating degrees of antimicrobial effect ([Anon., 2007, 2008](#); [Höfer, 2006](#); [Joiner, 2001](#)). Two groups of methods exist: agar diffusion tests, which provide qualitative analysis, and suspension tests for gaining quantitative values. Of course, in all tests, fabric without antimicrobial agents should be investigated as a control. *S. aureus* (Gram-positive), *E. coli* (Gram-negative), *Klebsiella pneumoniae* (Gram-negative) and *Candida albicans* are the most commonly used test organisms. The most important parameters of the tests are the challenge (100 colony-forming units (cfu)/fabric), control fabric comparable with the test fabric, a proper quality insurance system to assure the vitality of the strains and inoculum with low nutrient concentration or without nutrients (to model the real contamination; [Mucha, 2010](#)).

In agar diffusion tests (e.g., ISO 20645), the sample is placed on an agar plate inoculated with the test microbes. If after a certain incubation time, there are no bacteria

under the swatch, the textile is antimicrobial. If bacterial growth is inhibited around the sample as well, it means that the antimicrobial agent can diffuse from the fabric (leaching type agent).

In suspension tests, a bacteria suspension of a given concentration is placed in contact with the sample. After a certain incubation time, the bacteria are eluted from the fabric, and the suspension is diluted several times to get the proper number of bacteria. The diluted suspension is put on an agar plate, and then the incubation colonies are counted. The test can be carried out in static or in dynamic ('shaking flask') mode. The antimicrobial effect is characterized by the reduction ratio of the cfu. The reduction is expressed either as percentage value or as log value. The certificate about antimicrobial effect is issued when the reduction is more than 90% (1 log step; [Mucha, 2010](#)).

The most commonly used tests are as follows: ISO 20743, ASTM E 2149, AATCC 100, ISO 20645, EN 14119 (antimycotic) and AATCC 30 (antimycotic; [Mucha, 2010](#)). Exact descriptions of the standardized tests can be ordered from some institutes (e.g., AATCC in the United States). Qualification of the antimicrobial effect is provided by several accredited institutes. Additionally, antimicrobial tests and biocompatibility tests (cytotoxicity, sensitization, irritation) should be carried out before marketing the product.

20.5 Antimicrobial agents: silver, other metals and their salts

Silver is the best known of the various heavy metals toxic to microorganisms. In ancient times, it was used to make water potable, and for centuries, it has been used for the treatment of wounds, etc. A detailed review of silver NPs as a new generation of antimicrobials was published by [Rai et al. \(2009\)](#), and the manufacture of silver NPs was summarized by [Tolaymat et al. \(2010\)](#). In addition to medical and hygienic applications, silver containing fabrics can also be used to prevent biodegradation ([Klemenčič et al., 2010](#)) and for wastewater purification ([Unger and Lück, 2007](#)). The toxic effect of silver has also been recently presented (see later).

20.5.1 Mechanism

The exact mechanism of silver's antimicrobial effect is still unknown. Various mechanisms have been suggested for silver, silver ions and silver NPs. Silver binds to the bacterial cell wall and cell membrane and inhibits the respiration process. When silver ions penetrate the bacterial cell, the DNA molecule turns into a condensed form and loses its replication ability, leading to cell death. Silver NPs are very small and have extremely large surface areas. They get attached to the cell membrane, penetrate the bacteria, interact with sulphur-containing proteins and phosphorus-containing compounds and attack the respiratory chain. The NPs release silver ions into the bacterial cells, which enhance their bacterial activity. The antimicrobial effects of silver NPs depend on their size, shape and concentration ([Rai et al., 2009](#)). Agglomeration of NPs strongly decreases antimicrobial activity ([Klemenčič et al., 2010](#)). NPs can be

protected from agglomeration using dendrimer molecules: NPs are entrapped in the regular and highly branched three-dimensional architecture of dendrimers, for example, poly(amidoamine) (PAMAM; Ghosh et al., 2010; Pradeep and Anshup, 2009, p. 6454). More information about dendrimers' activity in chapter 13, volume 2. In addition to their antibacterial actions, silver NPs also have antifungal and antiviral effects, as reviewed by Vaidyanathan et al. (2009). Fabrics finished with silver ions proved to be more effective against bacteria than fungi (Tomšič et al., 2009).

20.5.2 Cellulose fibres

Silver and other metals (and their ions) can be bonded to cellulosic fibres by various methods. Silver salt has been incorporated into gel fibre used for wound healing (Newman et al., 2006). Cotton fabric can be padded with nanosized silver colloidal solution (Lee et al., 2003). Socks simply impregnated with copper oxide have been effectively used for healing wounds on the feet of diabetic patients. Copper not only fights against microorganisms but also absorbs through the skin and thus improves its well-being (Borkow et al., 2009). A copper-based biocidal compound has been used as a laundry additive because it has antibacterial effect even at low washing temperatures (Hall et al., 2009). Cotton can be pretreated with succinic acid anhydride to enhance the subsequent adsorption of silver and copper cations (Nakashima et al., 2001). Tannic acid–metal ion (Ag^+ , Zn^{2+} , Zr^{2+}) complexes have been developed in situ on jute fabrics (Higazy et al., 2010b). Polyvinyl pyridine–treated viscose fibre has been oxidized; N-oxide groups could incorporate silver and copper ions in complex form (Kantouch and El-Sayed, 2008). Metal ions embedded in various polymers have been used on the surfaces of cellulosic fibres: alginate chains were cross-linked with copper ions on cotton fibres to create a dressing material (Grace et al., 2009). Nanosilver was applied with polyvinyl alcohol (Wasif and Laga, 2009); poly(amidoamine) dendrimer was used with nanosilver on cotton/nylon blend fabric (Ghosh et al., 2010). Sol–gel methods have been applied with silver ions using water glass (Xing et al., 2007) or a commercial organic–inorganic binder (Tomšič et al., 2009), and the latter technology was used also with silver NPs combined with fluoroalkyl functional water-borne siloxane to obtain repellent properties (Tomšič et al., 2008). Silver ions can be released from a zeolite carrier used as coating (AGION, 2010). Silver, silver ions and QACs have been incorporated in silica coatings (Mahltig et al., 2004). Ag clusters were developed on cotton fabric combined with titanium dioxide. Although TiO_2 is a photomicrobicidal material (see later), silver alone was more effective than with TiO_2 (Yuranova et al., 2006). Silver ions can also be incorporated in cotton/polyester fabrics by chemisorptions into a fabric previously treated in a dielectric barrier discharge (Kostić et al., 2008). Thin layers of silver particles were deposited by plasma technology on cotton/polyester blend fabrics (Chadeau et al., 2010). Colloidal silver NPs have been developed in situ on cotton fabric using AgNO_3 and reducing agent NaBH_4 ; this process significantly alters the colour of the textile (Ilić et al., 2009). Silver NPs can be obtained via reduction by the residual starch content of the cotton fabric (Vigneshwaran et al., 2007).

20.5.3 Protein fibres

In protein fibres, the carboxyl groups are the active sites for metal cation adsorption. The adsorption capacity can be increased by various methods. Wool and silk can be treated with complexing agents such as tannic acid or ethylenediaminetetraacetic dihydride, respectively. Modified fibres react easily with silver and copper (Arai et al., 2001; Freddi et al., 2001; Tsukada et al., 2003). Wool fabric treated with sulphur nano-silver colloid has various functionalities, such as mothproofing, antibiotic and anti-static properties (Ki et al., 2007). Silver NPs have been immobilized on silk fibre by following the layer-by-layer deposition method. This method takes advantage of electrostatic interactions between oppositely charged polyelectrolytes; the fibres are dipped in diluted solutions of poly(diallyldimethylammonium chloride) and silver NPs were capped with poly(methacrylic acid) (PMA) using UV lamps. The reduction of silver ions by PMA led to the appearance of a pink colour, and the K/S value of the fabrics increased as a function of the number of layers (Dubas et al., 2006). Commercial products that contain silver are available for wool (NanoHorizons, 2008).

Silver in any form is slowly released from the fibre and can be depleted. Wash fastness of the metal-loaded textiles has rarely been mentioned, and, where it is studied at all, only the effects of about 10 washings are investigated. Many commercial products are available.

20.6 Antimicrobial agents: quaternary ammonium compounds

Cationic surfactants with long alkyl groups and quaternary ammonium groups are well-known disinfection agents.

20.6.1 Mechanism

QACs carry a positive charge at the N atom in solution. These chemicals, especially long alkyl group containing species such as cetylpyridinium chloride (bromide), have been used as disinfectants for a long time. Their effect is due to an electrostatic disruption of the cell wall subsequent to invasion by a lipophilic chain of specific length. The agent is not consumed in the process; hence, the antimicrobial activity is continual, so long as this bioactive material is attached to the surface. It is unlikely that microorganisms could become resistant to this type of attack because it would involve a major modification of their cell wall structure (Thomas et al., 2009).

20.6.2 Cellulose fibres

When anionic groups are introduced into the cellulose backbone, they increase the QAC bonding ability of cellulose (Son et al., 2006). Cotton surfaces can be given antimicrobial coatings using QAC-loaded alginate gel (Kim et al., 2010). Polymers, such as quaternary polyethyleneimines (PEI), have also been used as antimicrobial agents on

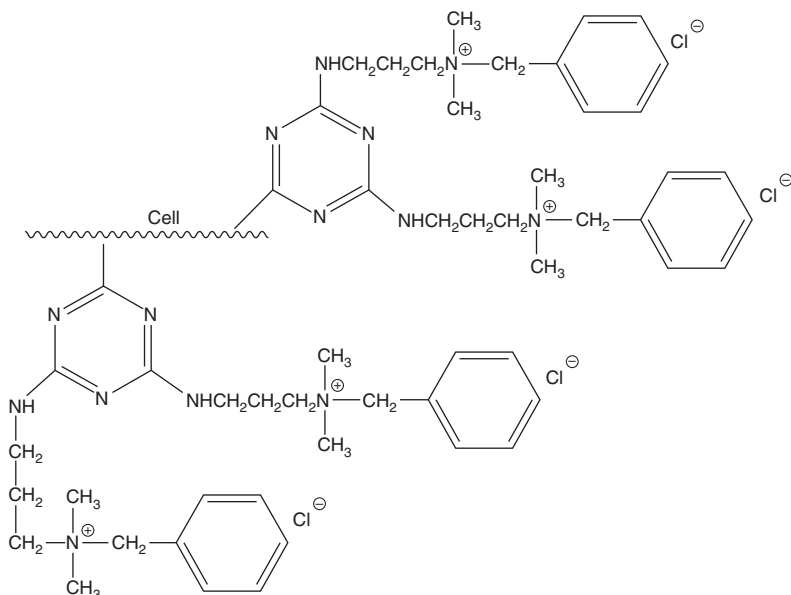

Figure 20.2 The structure of cellulose modified with multicationic benzyl groups (Hou et al., 2009).

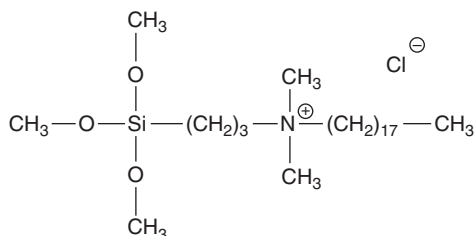

Figure 20.3 The structure of commercial 3-trimethoxy-silyl-propyl-dimethyloctadecyl ammonium chloride (AEGIS Microbe Shield).

cotton and wool. The antimicrobial activity of clothes modified with *N*-alkylated PEI strongly depends on the molecular weight of the polycation: only fabrics modified with large molecule weight polycation had significant bactericidal and fungicidal effects (Lin et al., 2003). Multicationic and long carbon chain groups can be covalently bonded to cellulosic fibres via chlorotriazine (see Fig. 20.2; Hou et al., 2009). Some products are anchored to the cellulose fibre through a silane group (see Fig. 20.3). Quaternary ammonium groups can be covalently bonded to cellulose by radiation-induced grafting as well (Goel et al., 2009; Kumar et al., 2005). Many of the examples cited above suggest that the size of the side chains bonded to the cellulose and the position of lipophilic and N^+ -containing groups are crucial for the antimicrobial efficacy. It is worth noting that the length of the alkyl chain also plays an important role in antimicrobial activity in the case of water-soluble cationic surfactants (QACs; Denny et al., 2005).

20.6.3 Protein fibres

QAC can be introduced into wool and silk fibres following tosylation of these protein fibres (Abel et al., 2003). Thiol group containing QAC are adsorbed on wool by means of ionic and hydrophobic interactions, and it can also be linked covalently due to its thiol functionality (Diz et al., 2001). Methods developed for cellulosic fibres can also be adapted for wool.

20.7 Antimicrobial agents: chitosan

Chitin is a natural polysaccharide, poly[β -(1,4)-2-acetamido-2-deoxy-D-glucopyranose], and is the main component of marine crustaceans. After cellulose, it is the most important natural polymer in the world. When the degree of deacetylation of chitin reaches about 50% (depending on the origin of the polymer), it becomes soluble in aqueous acidic media and is called chitosan (see Fig. 20.4). Its antimicrobial character is only one of many useful properties of chitosan (Lim and Hudson, 2003; Rinaudo, 2006). Chitosans and their derivatives can be used for production of fibres (Fan et al., 2006; Hirano et al., 2000; Ignatova et al., 2006; Jayakumar et al., 2010; Pillai et al., 2009; Wang et al., 2007).

20.7.1 Mechanism

In slightly acidic conditions (pH 5.3), chitosan is protonated, while the carboxyl and phosphate groups of the bacterial surface are anionic and offer potential sites for electrostatic binding (Helander et al., 2001; Li et al., 2010). Chitosan reacts with both cell walls and the cell membranes. Damage to cell membranes causes leakage of enzymes and nucleotides from different cell locations (Chung and Chen, 2008). Helander et al. (2001) pointed out that the mode of permeabilizing the action of chitosan resembled that of other polycationic molecules such as PEI. Antimicrobial activity depends on molecular weight (Liu et al., 2006; No et al., 2002; Park et al., 2004; Qin et al., 2006; Shin et al., 2001), degree of deacetylation (Park et al., 2004) and the type of bacterium (No et al., 2002). Water-insoluble chitosans exhibit antimicrobial action, while the water-soluble ones are not appropriate antimicrobial agents. Moreover, water-soluble chitosan and chitooligomer can promote the growth of *C. albicans* (Qin et al., 2006). On the other hand, in a microscopic study of very small molecules, chitooligosaccharides (COS) (<3 kDa) provoked more visible damage to the *Bacillus cereus* in vegetative form – most probably due to COS penetrating the

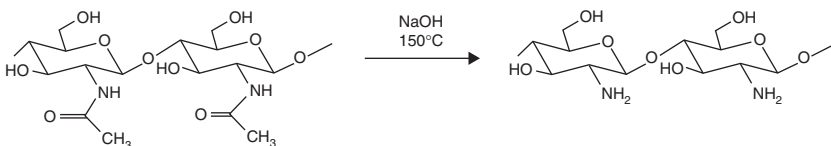

Figure 20.4 Chitosan production from chitin by deacetylation.

cells. Chitosan did not affect the spores, while COS could also weaken spore structure and their ability to contaminate, by inducing exosporium loss (Fernandes et al., 2009). Introducing metals or antimicrobial groups to chitosan enhances the antimicrobial effect of the material: silver NPs (Sanpui et al., 2008), copper, zinc and iron ions, respectively (Wang et al., 2005), silver, zinc and zirconium ions, respectively (Higazy et al., 2010a), TiO₂ and ZrO (Gouda and Keshk, 2010), quaternary ammonium groups (Kim et al., 1998, 2003; Seong et al., 2000) and guanidiny groups (Hu et al., 2007).

20.7.2 Cellulose fibres

Chitin and chitosan can be applied to cotton fabric in a simple pad-dry-cure technology (Gupta and Haile, 2007; Shin et al., 2001). The treated cotton fabric has better dyeability with direct and reactive dyes, but the anionic dyes, due to the capping of the positively charged amino groups, decreased antimicrobial activity (Gupta and Haile, 2007). Jute fabric has also been treated with metal salt containing chitosan in pad-dry-cure technology (Higazy et al., 2010a). Chitosan paste, with and without TiO₂ and ZrO, was coated and dried on the cotton fabric surface (Gouda and Keshk, 2010), and CuO was also applied with chitosan (Gouda and Hebeish, 2010). Cotton (Liu et al., 2001) and lyocell (Janjic et al., 2009) fibres can be oxidized by potassium periodate to obtain dialdehyde cellulose, which is able to form Schiff's base with chitosan. Nanoscale core shell particles with chitosan shell and poly(n-butyl acrylate) have been applied to cotton fabric without any chemical binders (Ye et al., 2005, 2006). Quaternary ammonium chloride derivative of chitosan can bond to cotton using the reaction between the hydroxyl group of cellulose and terminal aldehyde group in chitosan (Seong et al., 2000). Chitosan is mostly bonded to cellulose by some cross-linking compounds, mainly chemicals used in crease recovery finishing, to achieve proper durability: glutaric dialdehyde (Zhang et al., 2003), dimethyloldihydroxyethylene urea (Kim et al., 2003), glyoxal (Kittinaovarat et al., 2006), low formaldehyde resin (El-Tahlawy et al., 2005), butanetetracarboxylic acid (El-Tahlawy et al., 2005; Kim et al., 2003) and citric acid (Alonso et al., 2009; Chung et al., 1998; Kim et al., 2003). UV irradiation was used for activation of the cellulose surface (Alonso et al., 2009).

20.7.3 Protein fibres

Chitosan's binding to wool is very weak. Wool fabric is soaked in chitosan solution for a day, then padded and cured. Chitosan-treated fabric is antibacterial, and its henna dye uptake improves with treatment (Giri Dev et al., 2009). Better durability of antibacterial and shrink-proofing properties can be simply achieved by using very low molecular weight so-called nanochitosan (Yang et al., 2010). Citric acid can also be used for cross-linking in wool (Hsieh et al., 2004). Wool is acetylated by succinic anhydride and phthalic anhydride and then chitosan bonded to the acetyl groups (Ranjbar-Mohammadi et al., 2010).

20.8 Antimicrobial agents: dyes

The relationship between dyes and bacteria is of particular importance. The two major classes of bacteria ('Gram-positive' and 'Gram-negative') are distinguished by their dyeability, as discovered by the Danish bacteriologist Gram at the end of the 19th century. Acridine dyes were used on battle wounds to prevent sepsis in both world wars. Following the discovery of penicillin, very effective antibiotics could be used against bacteria, but nowadays, there is a global problem of microbial drug resistance, and thus antimicrobial dyes are becoming important once again (Wainwright, 2008).

20.8.1 Natural dyes

Various dyes were found to be antimicrobial and suggested for hospital use, especially on articles that are less suitable for laundering, such as mattresses and upholstery (Gupta et al., 2004). Textile material impregnated with these natural dyes shows less antimicrobial activity because uptake of these dyes in textile material is below the minimum concentration necessary for proper activity (Singh et al., 2005). Cationic Berberine dye can be applied to cotton pretreated with anionic surfactant (Kim and Son, 2005). Curcumin, a common nontoxic natural dye used in food, has an antimicrobial effect on wool. Unfortunately, its light fastness is low. Antimicrobial activity can be detected by the K/S value of the fabric (Han and Yang, 2005). The antimicrobial effect of henna on wool was improved by chitosan (Giri Dev et al., 2009).

20.8.2 Synthetic dyes

The antimicrobial dyes belong to the following chemical groups: acridine, triphenylmethane, phenothiazine, azo and fluorescence. They are used in dermatology but have some side effects (Balabanova et al., 2003). Gentian violet (crystal violet), the original Gram stain triphenylmethane type cationic dye, was successfully used against Methicillin-resistant *S. aureus* after some other agents failed (Saji et al., 1995). Recently synthesized antimicrobial anthraquinone dyes mostly contain quaternary ammonium groups (Liu et al., 2007; Liu and Sun, 2008a, 2009; Ma et al., 2003). The length of alkyl groups is also important in these dyes (Liu and Sun, 2009). A new disazo dye has been shown to have antifungal activity (Karci et al., 2009). Several benzophenone chromophoric groups were covalently bound to cotton cellulose. In addition to an antimicrobial effect, the modified cotton demonstrated pesticide degradation ability under UV irradiation as well (Hong and Sun, 2008). Introducing anionic groups into the cellulose backbone increased the adsorption of crystal violet (Borsa et al., 1989). *C. albicans* could not survive on cotton fabric with a small dye content (0.3 mg/g); K/S value of the dyed fabric characterizes its antimicrobial activity (Borsa et al., 2002a,b, 2003). Wool fibres are dyed by sulphonamide (Sayed and El-Gaby, 2001) and metal-containing (Tsukada et al., 2002) dyes.

20.9 Antimicrobial agents: photomicrobicidal materials

Nanoparticles of semiconductors, first of all TiO_2 , have recently been used for several special purposes, e.g., self-cleaning surfaces. Development of radicals in a photo-induced process, mechanism of microbes' damage and textile finishing methods are presented.

20.9.1 Role of semiconductors in antimicrobial activity

Semiconductors, such as TiO_2 , ZnO , Fe_2O_3 , etc., can act as sensitizers for light-induced redox processes due to their electronic structure, which is characterized by a filled valence band and an empty conduction band. Absorption of a photon of energy greater than the band gap energy leads to the formation of an electron/hole pair. In the absence of suitable scavengers, the stored energy is dissipated within a few nanoseconds by recombination. If a suitable scavenger or surface defect state is available to trap the electron or hole, recombination is prevented, and subsequent redox reactions may occur. The valence band holes are powerful oxidants, while the conduction band electrons are good reductants (Malato et al., 2009; see Fig. 20.5). Photocatalytic activity is enhanced by reduction in particle size (NPs): the excited electrons and holes can achieve surface by diffusion before recombination (Anpo et al., 1987). Because of its high oxidizing ability, high stability, nontoxicity and low cost, TiO_2 has been regarded as an ideal photocatalyst (Fujishima and Zhang, 2006). This photocatalytic effect can be used for various purposes, including water purification, air purification, self-cleaning surfaces, hydrogen production and chemical technologies. Photo-induced reactivity and application of titanium dioxide have been reviewed in detail (Carp et al., 2004; Fujishima and Zhang, 2006; Fujishima et al., 2008; Malato et al., 2009; Ni et al., 2007; Pozzo et al., 1997). TiO_2 has several crystal forms; anatase appears to be the most efficient from the catalytic point of view.

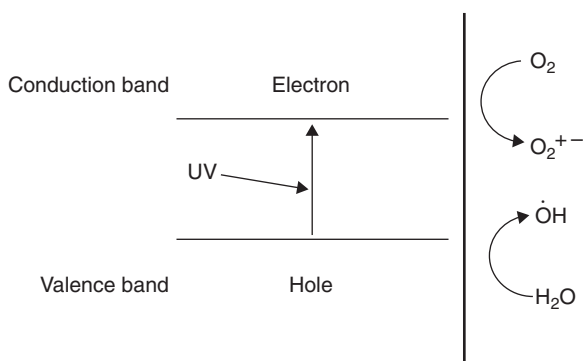

Figure 20.5 Fate of electrons and holes in a semiconductor particle in the presence of water.

20.9.2 Mechanism

The oxidative radicals' first target is the surface of the external membrane of the cell wall. Damage initially occurs to the lipopolysaccharides layer of the external cell wall and to the peptidoglycan layer. Next, peroxidation of the lipid membrane, oxidation of the proteins' membrane and of polysaccharides, takes place. Reduction or complete loss of membrane integrity leads to a loss of essential cell functions (Malato et al., 2009, p. 49).

20.9.3 Coating textiles

Relatively high temperatures, 400–600°C (Pozzo et al., 1997), are usually applied to obtain highly crystallized thin anatase coatings. With the development of TiO₂ synthesis methods at low temperature (about 100°C), TiO₂ coating of low thermal resistance substrates, such as textiles, is achievable. Two main routes have been explored for fixing TiO₂ onto any suitable support: application of previously made TiO₂ powder and in situ generation of TiO₂. The latter can be a sol–gel process, chemical vapour deposition and grafting (Pozzo et al., 1997). Previously made titanium dioxide (Degussa P-25 TiO₂) has effectively become a standard (Malato et al., 2009, p. 5). For textile coating in dip-coat technology, TiO₂ NPs (mostly Degussa P-25, anatase–rutile powder) (Bozzi et al., 2005a,b; Meilert et al., 2005; Kangwansupamonkon et al., 2009; Yuranova et al., 2006) and sol–gel processes (using, e.g., tetrabutyl titanate or titanium isopropoxide; Bozzi et al., 2005a,b; Daoud et al., 2005a,b; Tung and Daoud, 2009), are applied. Although TiO₂ is the most frequently studied semiconductor, ZnO has also been used as a photocatalyst on textiles (Perelshtein et al., 2009; Sivakumar et al., 2010; Vigneshwaran et al., 2006; Wang et al., 2004; Yadav et al., 2006).

The antibacterial activity of TiO₂-coated fabric has been tested under various conditions. UV radiation was more effective than white light. Although it is generally accepted that TiO₂ is bactericidally inactive in the absence of light, it was found that the cellulose–TiO₂ composite possessed a bactericidal property in presence and absence of light with different rates of cell destruction. These results suggested that a titania coating could not only perform as a photocatalytic bactericidal agent but also as a protective shield against the formation of biofilms in dark and light conditions (Daoud et al., 2005a). The leaching stability of the titania films coated on cotton by the sol–gel method after washing reveals a high level of adhesion, which might be attributable to a dehydration reaction between titania and the cellulosic hydroxyl groups of cotton (Daoud et al., 2005b). A combination of TiO₂ (Degussa 25) with silver under light was less active than in the dark. This phenomenon was explained by the reduction of Ag⁺ to the less bioactive Ag⁰ by the electron originating from TiO₂ (Yuranova et al., 2006). When TiO₂ is applied to organic materials, it can degrade the substrate. To avoid this undesired effect, apatite-coated TiO₂ was used on cotton cellulose. Reduction of bacteria after 24-h activation was very weak (15%–25%). Black light (<385 nm) was more effective than visible light (Kangwansupamonkon et al., 2009). There are unresolved problems with regards to explaining this fact. There was no bacterial growth on zinc oxide–soluble, starch composite–coated fabric

(Vigneshwaran et al., 2006). Only 0.75% ZnO on the fabric was sufficient for a ~100% reduction of *E. coli* and 66% reduction of *S. aureus* during 1-h treatment (Perelshtein et al., 2009). ZnO combined with chalcone and acacia resulted in 99% reduction of three pathogenic bacteria (Sivakumar et al., 2010). Nano ZnO antibacterial cotton fabric was relatively sensitive to acid artificial sweat but durable in saline or alkaline solution (Li et al., 2007).

It is necessary to note that the antimicrobial activities of these coatings described in some articles are very different, and in some cases, they are rather moderate in comparison with other antimicrobial fabrics. For example, on a TiO₂-coated cellulose surface illuminated by UV radiation, the reduction of *S. aureus* cells was about 40% (Daoud et al., 2005a), while quaternary ammonium group modified cotton killed >99% of the same bacteria during 1 h (Hou et al., 2009). Photomicrobicidal materials are promising antimicrobial agents for natural fibres; however, a better understanding is needed of the many parameters that might influence their effectiveness.

20.10 Antimicrobial agents: natural agents

There is more on this subject in Chapter 20 of Volume 1: 'Prevention of fungi growth in natural fibres'.

Natural materials with high-performance properties are very attractive to both manufacturers and consumers.

20.10.1 Inherently antimicrobial fibres

Some natural fibres are believed to be inherently antimicrobial, such as kapok (Wollina et al., 2003), hemp, flax and bamboo. Essential oils of industrial hemp can significantly inhibit microbial growth; the degree of inhibition depends on variety and sowing time (Nissen et al., 2010). The long-held assumption that flax is bacteriostatic or antibacterial was not supported by the results of a systematic investigation (Chun et al., 2009). Bamboo's antimicrobial activity, mentioned in the news worldwide, was denied by Federal Trade Commission, USA (2009). Inherently antimicrobial fibres can be formed from antimicrobial chitosan (see Section 20.7).

20.10.2 Natural bioactive agents on natural fibres

The major classes of antimicrobial compounds derived from plants are phenols, terpenoids, essential oils, alkaloids, lectins, polypeptides and polyacetylenes. In addition to chitosan and the natural dyes previously mentioned, silk sericin (protein from silkworm *Bombyx mori*), neem (*Azadirachta indica*) extract, aloe vera (*Aloe barbadensis*), tea tree (*Melaleuca alternifolia*), adzuki beans (*Vigna angularis*), prickly chaff flower (*Achyranthes aspera*), tulsi leaves (*Osmium basilicum*), clove oil (a product from *Syzygium aromaticum*), onion (*Allium cepa*) skin and pulp extracts, and some other herbal extracts, might possibly act as antimicrobial agents for textile finishing

(Joshi et al., 2009). When cotton fabric was treated with aloe vera gel extract in pad-dry-cure technology, the antimicrobial effect was retained after 50 washings (Jothi, 2009). Antimicrobial seaweed extract has also been applied to cotton (Sheeba and Thambidurai, 2009). Adsorption of neem extract on cotton is enhanced by plasma pretreatment of the fabric (Vaideki et al., 2007, 2008). Cotton fabric finished with tulsi (*Ocimum sanctum*) is both antifungal and antibacterial (Nagarajan, 2009). Cecropin B, a strongly cationic antimicrobial peptide (AMP) present in the insect hemolymph was covalently coupled to the *B. mori* silk fibroin by the carbodiimide chemistry method (Bai et al., 2008). Lysozyme, an enzyme found in large amount in egg white, can damage bacteria cell walls by catalyzing the hydrolysis of some cell components when bonded to wool fabric with glutaraldehyde. About half of the antimicrobial effect was lost after five washing cycles (Wang et al., 2009). Although there are many articles in this field, there are very few studies on systematic in-depth investigations. The proper quantity and equal quality of these products provide a great challenge (Joshi et al., 2009).

20.11 Antimicrobial agents: others

Several less important antimicrobials, such as poly(hexamethylene biguanide) (PHMB), triclosan, *N*-halamine and peroxyacid compounds, poly(*N*-vinyl-2-pyrrolidone) with iodine (PVP-I), chlorhexidine and some interesting new chemicals, are summarized in this section.

20.11.1 Poly(hexamethylene biguanide)

Cationic molecules with $=\text{NH}_2^+$ groups have a similar effect on microbes to other cationic agents. The commercial product, which is used as a disinfectant, is a mixture of molecules of different sizes. PHMB binds via weak ion–ion linkages with the carboxylate groups present on cotton; these bonds dissociate readily, releasing free PHMB. The attachment of PHMB to cotton can be increased by introducing anionic sites, for example, by dyeing. However, because of strong ionic bonding, the release of PHMB from cotton becomes less facile; hence, antimicrobial efficiency decreases, so a very large amount is needed (Kawabata and Taylor, 2006, 2007) and there is greater potential for bacterial resistance (Gao and Cranston, 2008).

20.11.2 Triclosan (2,4,4'-trichloro-2'-hydroxydiphenyl ether)

Triclosan is used in many commercial products, including fibres, mostly synthetic ones. It breaks down to toxic dioxin; hence, it is banned in some European countries (Gao and Cranston, 2008) and strongly criticized in the United States as well (Environmental Working Group, 2008).

20.11.3 Regenerable agents: N-halamine and peroxyacid

Oxidative groups are covalently bonded to the fibres. When deactivating a microorganism, the halamine bond (N—Cl) reversibly reacts to form N—H. It can be recharged with chlorine in a bleaching solution during laundering. Analogously, peroxyacids are converted to carboxylic acid and then regenerated in an oxygen bleach bath. The agents need regeneration to remain effective, but the residual adsorbed chlorine produces an unpleasant odour and discolours fabrics. A reduction step is needed to remove the unbounded residual chlorine (Gao and Cranston, 2008). In spite of these undesirable properties, this regenerable finishing of cotton fabric, especially with halamine, has been intensively studied (Barnes et al., 2006; Chen et al., 2007; Lee et al., 2007; Liu and Sun, 2006, 2008b; Luo and Sun, 2006; Qian and Sun, 2004; Ren et al., 2009a,b; Sun and Sun, 2002).

20.11.4 Poly(N-vinyl-2-pyrrolidone) with iodine (PVP-I)

Cotton fabric was thermally cross-linked with PVP. Posttreating with alcoholic iodine solution resulted in antibacterial activity against *S. aureus* and *E. coli*. Cellulose—PVP bonding was enhanced by easy-care finishing chemicals (Fahmy et al., 2009).

20.11.5 Chlorhexidine

Electron beam radiation has been used to induce grafting of glycidyl methacrylate/ β -cyclodextrin mixture onto cotton fabric. Chlorhexidine diacetate was incorporated into the cavities of cyclodextrin fixed on the cotton fabric to form an inclusion complex having antimicrobial activity (Abdel-Halim et al., 2010).

20.11.6 Antibiotics

Antibiotics, such as tetracycline or oxytetracycline, were bonded to cotton fibre in zirconium complex form. The finish had very good wash fastness (Morris et al., 1981).

20.11.7 Amino-terminated hyperbranched polymer (HBP—NH₂)

An amino-terminated hyperbranched polymer (HBP—NH₂) was grafted to cotton fabric by a reaction between the aldehyde groups of oxidized cotton fabric and the amino groups of the HBP—NH₂ to provide cotton fabric with durable antimicrobial properties (Zhang et al., 2009).

20.11.8 Trimethoprim and sulfamethoxazole

Trimethoprim and sulfamethoxazole were modified to act as reactive dyes and were covalently bonded to the surface of cotton to impart antibacterial properties (Chun and Gamble, 2007).

20.11.9 Built in anionic groups

Cotton cellulose was slightly carboxymethylated using monochloroacetic acid and sodium hydroxide to substitute 2%–3% of the hydroxyl groups for $-\text{CH}_2-\text{COOH}$ groups. The slightly carboxymethylated cotton fabric was effective against *E. coli* and *S. aureus*, but acidophilic bacteria *Acetobacter* could survive on the surface. Thus, one can suppose that the acidic groups built into the fibre are effective against pathogenic bacteria. Because of the stability of the ether bond between cellulose and carboxymethyl groups, the modification is durable (Borsa and Lázár, 2007).

20.11.10 Ar–CF₄ postdischarge plasma treatment

Cotton, wool and polyamide 6 fabrics were treated with an Ar–CF₄ postdischarge plasma. Fluorination of the surface was achieved on all materials studied, but only wool- and polyamide 6–fluorinated surfaces become hydrophobic and antibacterial. No antifungal effect occurred (Canal et al., 2009).

20.11.11 Enzymatic grafting

Chitosan was grafted onto flax fabric by the oxidative laccase enzyme (Silva et al., 2009). The water-insoluble phenolic compound lauryl gallate was developed on wool fabric, also by laccase (Gaffar Hossain et al., 2009).

20.12 Risks of antimicrobial finishing

The skin is an important immune organ with nonspecific and specific activities. Antimicrobial textiles may interfere with the skin's nonspecific defence mechanisms such as AMPs or resident microflora (Wollina et al., 2006).

Among the aforementioned antimicrobial agents, chitosan and lysozyme are used for antimicrobial food packaging and therefore must be harmless (Appendini and Hotchkiss, 2002). Silver is incorporated in some bulk food storage containers, plastic or paper food wraps, milk containers, etc (Appendini and Hotchkiss, 2002; Bouwmeester et al., 2009). In the latter article (Bouwmeester et al., 2009), the possible hazards of NPs in food production are discussed.

20.12.1 Nanoparticles

Because of their extremely small size, NPs have very special properties. The possible undesirable results of their capabilities, such as harmful interactions with biological systems and the environment with the potential to generate toxicity, were recently reviewed by many authors (Nel et al., 2006; Reijnders, 2006). Silver NPs interact with the key components of the mammalian cell's antioxidant defence mechanism causing an intracellular oxidative stress (Chen and Schluesner, 2008; Kim et al., 2009). Toxic effects of some NPs were compared by their L(C)50 values determined in various organism groups (e.g., crustaceans, fish, nematodes, etc.). L(C) stands for

‘lethal concentration’. L(C) values usually refer to the concentration of a chemical in air, but in environmental studies, it can also mean the concentration of a chemical in water. For inhalation experiments, the concentration of the chemical in air that kills 50% of the test animals in a given time, usually 4 h, is the L(C)50 value (Canadian Centre for Occupational Health and Safety, 2005). On the basis of median values, the most harmful were nano-Ag and nano-ZnO (L(C)50 < 0.1 mg/L, ‘extremely toxic’). Nano TiO₂ was classified as ‘harmful’ (L(C)50 10–100 mg/L; Kahru and Dubouguier, 2010). NP waste can cause serious problems if it accumulates in the environment (Blaser et al., 2008; Bystrzejewska-Piotrowska et al., 2009).

20.12.2 *Triclosan*

As mentioned above (see Section 14.11), triclosan, used in many commercial products, breaks down to toxic dioxin. It is banned in some European countries (Gao and Cranston, 2008) and strongly criticized in the United States (Environmental Working Group, 2008). Nursing mothers using triclosan-containing hygienic products, and a control group, were investigated. Triclosan and/or its metabolites were found in plasma and breast milk. The concentrations were significantly higher in plasma than in milk, indicating that infant exposure to triclosan via breast milk is much less than the dose in the mother. A small amount of triclosan was also found in the control group. This suggests that there are sources of human exposure other than personal care products. There are many scientific hypotheses on the mechanism of triclosan’s toxicity for human cells, but the long-term effects of a chronic systemic exposure to triclosan in humans are not fully understood. The authors (Allmyr et al., 2006) pointed out that the beneficial effects of triclosan in hygiene were not clinically evident; hence, its general use was questioned.

20.13 Future trends

Silver, QACs, triclosan (in spite of its possible toxicity) and PHMB are available commercially (Gao and Cranston, 2008). Control of the size and shape of silver NPs (e.g., Pillai and Kamat, 2004) may be a topic of some further studies on silver’s antimicrobial activity, durability and possible toxicity.

Valuable results on chitosan might result in the development of commercial products.

Dyes are common chemicals in the textile industry, so their possible application for antimicrobial finishing has several advantages.

Photomicrobicidal agents are multifaceted materials; their properties and possible applications, such as antimicrobial finishing, have been the focus of recent research.

The self-cleaning properties of semiconductor-coated fabrics depend on many parameters, which need a long further study. When these are marketed, they will probably be used for fabrics that are not in contact with the skin. The hazards associated with NPs, which were recently discovered, might focus research on the durability issues.

Some interesting complex products were studied several years ago, and these former results may be the starting points of further research, for example, perfluoroalkyl-containing quaternary ammonium salt for antimicrobial, water, oil, soil and blood repellent fabric (Shao et al., 2003).

Natural agents (herbal extracts) are important environmentally friendly technologies, but because of their relatively low antimicrobial effect, they can only be used for everyday purposes, and not in hospitals.

AMPs might in future be used as active agents for producing antimicrobial fibres. They have recently been intensively investigated because the increasing resistance of microorganisms to common antibiotics has become a growing threat to public health. AMPs are part of the innate immune system and have a large spectrum of antimicrobial activities against Gram-positive and Gram-negative bacteria, fungi (Ajesh and Sreejith, 2009; Hancock and Diamond, 2000) and viruses (Hancock and Diamond, 2000). They are cationic and hence cytotoxic against bacteria due to their damaging effect to cell membranes (Epanand and Vogel, 1999). AMPs are widely distributed in nature, from insects to plants and animal species (Ramos et al., 2010), and they even exist on human skin (Howell, 2007; Wollina et al., 2006). Moreover, they may interfere with the effect of antimicrobial textiles (Wollina et al., 2006). Applying *Ceropin B* AMP to silk fibroin (Bai et al., 2008), binding lysozyme on wool (Wang et al., 2009) and using AMP with a cellulose-binding module (Ramos et al., 2010) are the first steps towards development of natural fibres containing AMPs as antimicrobial agent.

Reversing the topic of the chapter, we can think about a relatively new application of natural fibres regarding bacteria: fibres and fabrics can be supports for bacteria in bioreactors (e.g., Yang et al., 2009). Because natural fibres are damaged by various bacteria, proper coatings should be developed for these purposes.

References

- Abdel-Halim, E.S., Fouda, M.M.G., Hamdy, I., Abdel-Mohdy, F.A., El-Sawy, S.M., 2010. Incorporation of chlorohexidin diacetate into cotton fabrics grafted with glycidyl methacrylate and cyclodextrin. *Carbohydr. Polym.* 79, 47–53.
- Abel, T., Cohen, J.L.I., Escalera, J., Engel, R., Filshtinskaya, M., Fincher, R., Melkonian, A., Melkonian, K., 2003. Preparation and investigation of antibacterial protein-based surfaces. *J. Text. Apparel Technol. Manag.* 3 (2). Available from: http://www.tx.ncsu.edu/jtatm/volume3issue2/Articles/Engel/engel_full_55_03.pdf.
- AGION, 2010. Nature's Antimicrobial. Available from: <http://www.agion-tech.com/Technology.aspx?id=156>.
- Aibibu, D., Lehman, B., Offermann, P., 2003. Image analysis for testing and evaluation of the barrier effect of surgical gowns. *J. Text. Apparel Technol. Manag.* 3 (2). Available from: http://www.tx.ncsu.edu/jtatm/volume3issue2/Articles/Aibibu/aibibu_full_52_03.pdf.
- Ajesh, K., Sreejith, K., 2009. Peptide antibiotics: an alternative and effective antimicrobial strategy to circumvent fungal infections. *Peptides* 30, 999–1006.

- Allmyr, M., Adolfsson-Erici, M., McLachlan, M.S., Sandborgh-Englund, G., 2006. Triclosan in plasma and milk from Swedish nursing mothers and their exposure via personal care products. *Sci. Total Environ.* 372, 87–93.
- Alonso, D., Gimeno, M., Olayo, R., Vázquez-Torres, H., Sepúlveda-Sánchez, J.D., Shirai, K., 2009. Cross-linking chitosan into UV-irradiated cellulose fibers for the preparation of antimicrobial-finished textiles. *Carbohydr. Polym.* 77, 536–543.
- Anon, 2005. New Multifunctional Textiles: Antimicrobial Treatments. Available from: <http://ebook-free-downloads.com/ebook-ppt-free-ppt-download-centrum-page-2.htm>.
- Anon, 2007. Analysis and Assessment of Current Protocols to Develop Harmonised Test Methods and Relevant Performance Standards for the Efficacy Testing of Treated Articles/treated Materials. Available from: [http://www.oilis.oecd.org/oilis/2007doc.nsf/LinkTo/NT00000B46/\\$FILE/JT03222464.PDF](http://www.oilis.oecd.org/oilis/2007doc.nsf/LinkTo/NT00000B46/$FILE/JT03222464.PDF).
- Anon, 2008. Guidance Document on the Evaluation of the Efficacy of Antimicrobial Treated Articles with Claims for External Effects. Available from: <http://www.oecd.org/dataoecd/11/43/41692131.pdf>.
- Anpo, M., Shima, T., Kodama, S., Kubokawa, Y., 1987. Photocatalytic hydrogenation of propyne with water on small-particle titania: size quantization effects and reaction intermediates. *J. Phys. Chem.* 91, 4305–4310.
- Appendini, P., Hotchkiss, J.H., 2002. Review of antimicrobial food packaging. *Innov. Food Sci. Emerg. Technol.* 3, 113–126.
- Arai, T., Freddi, G., Colonna, G.M., Scotti, E., Boschi, A., Murakami, R., Tsukada, M., 2001. Absorption of metal cations by modified *B. mori* silk and preparation of fabrics with antimicrobial activity. *J. Appl. Polym. Sci.* 80, 297–303.
- Araujo-Marques, M.J., Cabeco-Silva, M.E., 2001. Influence of sterilisation on the properties and performance of O. R. disposable garments. In: Anand, S. (Ed.), *Medical Textiles*. Woodhead Publishing, Cambridge, pp. 124–130.
- Bai, L., Zhu, L., Min, S., Liu, L., Cai, Y., Yao, J., 2008. Surface modification and properties of *Bombyx mori* silk fibroin films by antimicrobial peptide. *Appl. Surf. Sci.* 254, 2988–2995.
- Balabanova, M., Popova, L., Tchipeva, R., 2003. Dyes in dermatology. *Clin. Dermatol.* 21, 2–6.
- Barnes, K., Liang, J., Wu, R., Worley, S.D., Lee, J., Broughton, R.M., Huang, T.S., 2006. Synthesis and antimicrobial applications of 5,5'-ethylenebis[5-methyl-3-(3-triethoxysilylpropyl)hydantoin]. *Biomaterials* 27, 4825–4830.
- Bellchambers, J., Harris, J.M., Cullinan, P., Gaya, H., Pepper, J.R., 1999. A prospective study of wound infection in coronary artery surgery. *Eur. J. Cardiothorac. Surg.* 15, 45–50.
- Blaser, S.A., Scheringer, M., MacLeod, M., Hungerbühler, K., 2008. Estimation of cumulative aquatic exposure and risk due to silver: contribution of nano-functionalized plastics and textiles. *Sci. Total Environ.* 390, 396–409.
- Borkow, G., Gabbay, J., 2008. Biocidal textiles can help fight nosocomial infections. *Med. Hypotheses* 70, 990–994.
- Borkow, G., Zatzoff, R.C., Gabbay, J., 2009. Reducing the risk of skin pathologies in diabetics by using copper impregnated socks. *Med. Hypotheses* 73, 883–886.
- Borsa, J., Lázár, K., 2007. Antibacterial cotton fibre. In: Anandjiwala, R., Hunter, L., Kozłowski, R., Zaikov, G. (Eds.), *Textiles for Sustainable Development*. Nova Science Publishers, New York, pp. 13–20.
- Borsa, J., Kálmán, F., Rusznák, I., 1989. Equilibrium sorption of crystal violet by carboxymethylated cellulose with low degree of substitution. *Colloid Polym. Sci.* 267, 915–922.
- Borsa, J., Rácz, I., Tóth, T., 2002a. Chemical modification of cotton cellulose for medical textiles. In: *Proceedings of the 2nd Autex Conference*, 584. Bruges, Belgium.

- Borsa, J., Tóth, T., Rác, I., Balkan, S.B., 2002b. The role of anionic groups and improved accessibility of chemically modified cellulose in adsorption and release of cationic molecules. In: Proceedings of the 1st International Cellulose Conference, 132. Kyoto, Japan.
- Borsa, J., Zala, J., Kiss, K., Lázár, K., Tóth, T., Horváth, E., 2003. Antimicrobial cotton fabric for hospital use. In: Proceedings of the 2nd European Conference on Protective Clothing (ECPC) and NOKOBETEF 7, P 3, CD. Montreux, Switzerland.
- Bouwmeester, H., Dekkers, S., Noordam, M.Y., Hagens, W.I., Bulder, A.S., de Heer, C., ten Voorde, S.E.C.G., Wijnhoven, S.W.P., Marvin, H.J.P., Sips, A.J.A.M., 2009. Review of health safety aspects of nanotechnologies in food production. *Regul. Toxicol. Pharmacol.* 53, 52–62.
- Bozzi, A., Yuranova, T., Guasaquillo, I., Laub, D., Kiwi, J., 2005a. Self-cleaning of modified cotton textiles by TiO₂ at low temperatures under daylight irradiation. *J. Photochem. Photobiol. A Chem.* 174, 156–164.
- Bozzi, A., Yuranova, T., Kiwi, J., 2005b. Self-cleaning of wool-polyamide and polyester textiles by TiO₂-rutile modification under daylight irradiation at ambient temperature. *J. Photochem. Photobiol. A Chem.* 172, 27–34.
- Brown, P.L., 1996. Assessment of the protective properties of textiles against microorganisms. In: Raheel, M. (Ed.), *Modern Textile Characterization Methods*. Marcel Dekker, New York, pp. 469–550.
- Bystrzejewska-Piotrowska, G., Golimowski, J., Urban, P.L., 2009. Nanoparticles: their potential toxicity, waste and environmental management. *Waste Manag.* 29, 2587–2595.
- Canadian Centre for Occupational Health and Safety, 2005. What is LD50 and LC50. Available from: <http://www.ccohs.ca/oshanswers/chemicals/ld50.html>.
- Canal, C., Gaboriau, F., Villeger, S., Cvelbar, U., Ricard, A., 2009. Studies on antibacterial dressings obtained by fluorinated post-discharge plasma. *Int. J. Pharm.* 367, 155–161.
- Carp, O., Huisman, C.L., Reller, A., 2004. Photoinduced reactivity of titanium dioxide. *Prog. Solid State Chem.* 32, 133–177.
- Chadeau, E., Oulahal, N., Dubost, L., Favergeon, F., Degraeve, P., 2010. Anti-*Listeria Innocua* activity of silver functionalised textile prepared with plasma technology. *Food Control* 21, 505–512.
- Chen, X., Schluesner, H.J., 2008. Nanosilver: a nanoproduct in medical application. *Toxicol. Lett.* 176, 1–12.
- Chen, Z., Luo, J., Sun, Y., 2007. Biocidal efficacy, biofilm-controlling function, and controlled release effect of chloromelamine-based bioresponsive fibrous materials. *Biomaterials* 28, 1597–1609.
- Chu, Y.-F., Hsu, C.-H., Soma, P.K., Lo, Y.M., 2009. Immobilization of bioluminescent *Escherichia coli* cells using natural and artificial fibers treated with polyethyleneimine. *Bioresour. Technol.* 100, 3167–3174.
- Chun, D.T.W., Foulk, J.A., McAlister III, D.D., 2009. Testing for antibacterial properties of cotton/flax denim. *Ind. Crops Prod.* 29, 371–376.
- Chun, D.T.W., Gamble, G.R., 2007. Using the reactive dye method to covalently attach antibacterial compounds to cotton. *J. Cotton Sci.* 11, 154–158. Available from: <http://www.cotton.org/journal/2007-11/3/upload/jcs11-154.pdf>.
- Chung, Y.-C., Chen, C.-Y., 2008. Antibacterial characteristics and activity of acid-soluble chitosan. *Bioresour. Technol.* 99, 2806–2814.
- Chung, Y.S., Lee, K.K., Kim, J.W., 1998. Durable press and antimicrobial finishing of cotton fabrics with a citric acid and chitosan treatment. *Text. Res. J.* 68, 772–775.

- Cooper, B.S., Medley, G.F., Scott, G.M., 1999. Preliminary analysis of the transmission dynamics of nosocomial infections: stochastic and management effects. *J. Hosp. Infect.* 43, 131–147.
- Curtis, L.T., 2008. Prevention of hospital-acquired infections: review of non-pharmacological interventions. *J. Hosp. Infect.* 69, 204–219.
- Daoud, W.A., Xin, J.H., Zhang, Y.-H., 2005a. Surface functionalization of cellulose fibers with titanium dioxide nanoparticles and their combined bactericidal activities. *Surf. Sci.* 599, 69–75.
- Daoud, W.A., Xin, J.H., Zhang, Y.-H., Qi, K., 2005b. Surface characterization of thin titania films prepared at low temperatures. *J. Non-Cryst. Solids* 351, 1486–1490.
- Das, I., Lambert, P., Hill, D., Noy, M., Bion, J., Elliott, T., 2002. Carbapenem-resistant *Acinetobacter* and role of curtains in an outbreak in intensive care units. *J. Hosp. Infect.* 50, 110–114.
- Denny, B.J., Novotny, L., West, P.W.J., Blesova, M., Zamocka, J., 2005. Antimicrobial activity of a series of 1-alkyl-2-(4-pyridyl)pyridinium bromides against Gram-positive and Gram-negative bacteria. *Med. Princ. Pract.* 14, 377–381.
- Diz, M., Infante, M.R., Erra, P., 2001. Antimicrobial activity of wool treated with a new thiol cationic surfactant. *Text. Res. J.* 71, 695–700.
- Dubas, S.T., Kumlangdudsana, P., Potiyaraj, P., 2006. Layer-by-layer deposition of antimicrobial silver nanoparticles on textile fibers. *Colloid. Surf. Physicochem. Eng. Asp.* 289, 105–109.
- El-Tahlawy, K.F., El-Bendary, M.A., Elhendawy, A.G., Hudson, S.M., 2005. The antimicrobial activity of cotton fabrics treated with different crosslinking agents and chitosan. *Carbohydr. Polym.* 60, 421–430.
- Environmental Working Group, 2008. Pesticide in Soap, Toothpaste and Breast Milk – is it Kid-Safe? Available from: <http://www.ewg.org>.
- Epanand, R.M., Vogel, H.J., 1999. Diversity of antimicrobial peptides and their mechanisms of action. *Biochim. Biophys. Acta* 1462, 11–28.
- Fahmy, H.M., Abo-Shosha, M.H., Ibrahim, N.A., 2009. Finishing of cotton fabrics with poly (*N*-vinyl-2-pyrrolidone) to improve their performance and antibacterial properties. *Carbohydr. Polym.* 77, 845–850.
- Fan, L., Du, Y., Zhang, B., Yang, J., Zhou, J., Kennedy, J.F., 2006. Preparation and properties of alginate/carboxymethyl chitosan blend fibers. *Carbohydr. Polym.* 65, 447–452.
- Federal Trade Commission, 2009. FTC Charges Companies with ‘Bamboo-Zling’ Consumers with False Product Claims. Available from: <http://www.ftc.gov/opa/2009/08/bamboo.shtm>.
- Fernandes, J.C., Eaton, P., Gomes, A.M., Pintado, M.E., Malcata, F.X., 2009. Study of the antibacterial effects of chitosans on *Bacillus cereus* (and its spores) by atomic force microscopy imaging and nanoindentation. *Ultramicroscopy* 109, 854–860.
- Ferreira, L.M., Casimiro, M.H., Oliveira, C., Cabeço-Silva, M.E., Marques Abreu, M.J., Coelho, A., 2002. Thermal analysis evaluation of mechanical properties changes promoted by gamma radiation on surgical polymeric textiles. *Nucl. Instrum. Methods Phys. Res. Sect. B Beam Interact. Mater. Atoms* 191, 675–679.
- Fibre2fashion, 2010. Antimicrobial Products in Textile Industry. Available from: <http://www.fibre2fashion.com/industry-article/11/1017/antimicrobial-products-in-textile-industry1.asp>.
- Freddi, G., Arai, T., Colonna, G.M., Boschi, A., Tsukada, M., 2001. Binding of metal cations to chemically modified wool and antimicrobial properties of the wool–metal complexes. *J. Appl. Polym. Sci.* 82, 3513–3519.

- Fujishima, A., Zhang, X., 2006. Titanium dioxide photocatalysis: present situation and future approaches. *Compt. Rendus Chem.* 9, 750–760.
- Fujishima, A., Zhang, X., Tryk, D.A., 2008. TiO₂ photocatalysis and related surface phenomena. *Surf. Sci. Rep.* 63, 515–582.
- Gaffar Hossain, K.M., Díaz González, M., Rocasalbas Lozano, G., Tzanov, T., 2009. ‘Multi-functional modification of wool using an enzymatic process in aqueous–organic media’. *J. Biotechnol.* 141, 58–63.
- Gao, Y., Cranston, R., 2008. Recent advances in antimicrobial treatments of textiles. *Text. Res. J.* 78, 60–71.
- Gastmeier, P., Schwab, F., Bärwolff, S., Rüden, H., Grundmann, H., 2006. Correlation between the genetic diversity of nosocomial pathogens and their survival time in intensive care units. *J. Hosp. Infect.* 62, 181–186.
- Ghosh, S., Yadav, S., Vasanthan, N., Sekosan, G., 2010. A study of antimicrobial property of textile fabric treated with modified dendrimers. *J. Appl. Polym. Sci.* 115, 716–722.
- Giri Dev, V.R., Venugopal, J., Sudha, S., Deepika, G., Ramakrishna, S., 2009. Dyeing and antimicrobial characteristics of chitosan treated wool fabrics with henna dye. *Carbohydr. Polym.* 75, 646–650.
- Girrbach, U., 2003. Bioactive textiles: trend or gimmick? *Int. Text. Bull.* 2, 34–35.
- Goel, N.K., Rao, M.S., Kumar, V., Bhardwaj, Y.K., Chaudhari, C.V., Dubey, K.A., Sabharwal, S., 2009. Synthesis of antibacterial cotton fabric by radiation-induced grafting of [2-(methacryloyloxy)ethyl]trimethylammonium chloride (MAETC) onto cotton. *Radiat. Phys. Chem.* 78, 399–406.
- Gorman, S.P., McGovern, J.G., Woolfson, A.D., Adair, C.G., Jones, D.S., 2001. The concomitant development of poly(vinyl chloride)-related biofilm and antimicrobial resistance in relation to ventilator-associated pneumonia. *Biomaterials* 22, 2741–2747.
- Gouda, H., Hebeish, A., 2010. Preparation and evaluation of CuO/chitosan nanocomposite for antibacterial finishing cotton fabric. *J. Ind. Text.* 39, 203–214.
- Gouda, M., Keshk, S.M.A.S., 2010. Evaluation of multifunctional properties of cotton fabric based on metal/chitosan film. *Carbohydr. Polym.* 80, 505–513.
- Gough, N.L., Dodd, C.E.R., 1998. The survival and disinfection of *Salmonella typhimurium* on chopping board surfaces of wood and plastic. *Food Control* 6, 363–368.
- Grace, M., Chand, N., Bajpai, S.K., 2009. Copper alginate–cotton cellulose (CACC) fibers with excellent antibacterial properties. *J. Eng. Fibers Fabrics* 4, 24–34. Available from: <http://www.jeffjournal.org>.
- Gupta, D., Haile, A., 2007. Multifunctional properties of cotton fabric treated with chitosan and carboxymethyl chitosan. *Carbohydr. Polym.* 69, 164–171.
- Gupta, D., Khare, S.K., Laha, A., 2004. Antimicrobial properties of natural dyes against Gram-negative bacteria. *Color. Technol.* 120, 167–171.
- Hall, T.J., Wren, M.W.D., Jeanes, A., Gant, V.A., 2009. Decontamination of laundry at low temperature with CuWB50, a novel copper-based biocidal compound. *Am. J. Infect. Contr.* 37, 478–483.
- Han, S., Yang, Y., 2005. Antimicrobial activity of wool fabric treated with curcumin. *Dyes Pigments* 64, 157–161.
- Hancock, R.E., Diamond, G., 2000. The role of cationic antimicrobial peptides in innate host defences. *Trends Microbiol.* 8, 402–410.
- Helander, I.M., Nurmiäho-Lassila, E.-L., Ahvenainen, R., Rhoades, J., Roller, S., 2001. Chitosan disrupts the barrier properties of the outer membrane of Gram-negative bacteria. *Int. J. Food Microbiol.* 71, 235–244.

- Higazy, A., Hashem, M., El Shafei, A., Shaker, N., Hady, M.A., 2010a. Development of antimicrobial jute packaging using chitosan and chitosan-metal complex. *Carbohydr. Polym.* 79, 867–874.
- Higazy, A., Hashem, M., El Shafei, A., Shaker, N., Hady, M.A., 2010b. ‘Development of antimicrobial jute fabrics via *in situ* formation of cellulose–tannic acid–metal ion complex’. *Carbohydr. Polym.* 79, 890–897.
- Hilburn, J., Hammond, B.S., Fendler, E.K., Groziak, P.A., 2003. Use of alcohol hand sanitizer as an infection control strategy in an acute care facility. *Am. J. Infect. Contr.* 31, 109–116.
- Hirano, S., Zhang, M., Nakagawa, M., Miyata, T., 2000. Wet spun chitosan–collagen fibers, their chemical *N*-modifications, and blood compatibility. *Biomaterials* 21, 997–1003.
- Höfer, D., 2006. Antimicrobial textiles – evaluation of their effectiveness and safety. In: Hipler, U.-C., Elsner, P. (Eds.), *Biofunctional Textiles and the Skin: Current Problems in Dermatology*, vol. 33. Karger, Basel, pp. 42–55.
- Hong, K.H., Sun, G., 2008. Antimicrobial and chemical detoxifying functions of cotton fabrics containing different benzophenone derivatives. *Carbohydr. Polym.* 71, 598–605.
- Hou, A., Zhou, M., Wang, X., 2009. Preparation and characterization of durable antibacterial cellulose biomaterials modified with triazine derivatives. *Carbohydr. Polym.* 75, 328–332.
- Howell, M.D., 2007. The role of human beta defensins and cathelicidins in atopic dermatitis. *Curr. Opin. Allergy Clin. Immunol.* 7, 413–417.
- Hsieh, S.H., Huang, Z.K., Huang, Z.Z., Tseng, Z.S., 2004. Antimicrobial and physical properties of woollen fabrics cured with citric acid and chitosan. *J. Appl. Polym. Sci.* 94, 1999–2007.
- Hu, Y., Du, Y., Yang, J., Kennedy, J.F., Wang, X., Wang, L., 2007. Synthesis, characterization and antibacterial activity of guanidinylated chitosan. *Carbohydr. Polym.* 67, 66–72.
- Ignatova, M., Starbova, K., Markova, N., Manolova, N., Rashkov, I., 2006. Electrospun nanofibre mats with antibacterial properties from quaternised chitosan and poly(vinyl alcohol). *Carbohydr. Res.* 341, 2098–2107.
- Ilić, V., Šaponjić, Z., Vodnik, V., Potkonjak, B., Jovančić, P., Nedeljković, J., Radetić, M., 2009. The influence of silver content on antimicrobial activity and color of cotton fabrics functionalized with Ag nanoparticles. *Carbohydr. Polym.* 78, 564–569.
- Janjic, S., Kostic, M., Vucinic, V., Dimitrijevic, S., Popovic, K., Ristic, M., Skundric, P., 2009. Biologically active fibers based on chitosan-coated lyocell fibers. *Carbohydr. Polym.* 78, 240–246.
- Jayakumar, R., Prabakaran, M., Nair, S.V., Tamura, H., 2010. Novel chitin and chitosan nanofibers in biomedical applications. *Biotechnol. Adv.* 28, 142–150.
- Jensen, J.-U.S., Jensen, E.T., Larsen, A.R., Meyer, M., Junker, L., Rønne, T., Skov, R., Jepsen, O.B., Andersen, L.P., 2006. Control of a methicillin-resistant *Staphylococcus aureus* (MRSA) outbreak in a day-care institution. *J. Hosp. Infect.* 63, 84–92.
- Joiner, B.G., 2001. Determining antimicrobial efficacy and biocompatibility of treated articles using standard test methods. In: Edwards, J.V., Vigo, T.L. (Eds.), *Bioactive Fibers and Polymers*. American Chemical Society, Washington, pp. 201–217.
- Joshi, M., Wazed, A.S., Purwar, R., 2009. Ecofriendly antimicrobial finishing of textiles using bioactive agents based on natural products. *Indian J. Fiber Text. Res.* 34, 295–304.
- Jothi, H., 2009. Experimental study on antimicrobial activity of cotton fabric treated with aloe gel extract from *Aloe vera* plant for controlling the *Staphylococcus aureus* (bacterium). *Afr. J. Microbiol. Res.* 3, 228–232. Available from: <http://www.academicjournals.org/AJMR/PDF/Pdf2009/May/Jothi.pdf>.
- Kahru, A., Dubouguier, H.-C., 2010. From ecotoxicology to nanoecotoxicology. *Toxicology* 269, 105–119.

- Kampf, G., 2004. The six golden rules to improve compliance in hand hygiene. *J. Hosp. Infect.* 56, S3–5.
- Kampf, G., Kramer, A., 2004. Epidemiologic background of hand hygiene and evaluation of the most important agents for scrubs and rubs. *Clin. Microbiol. Rev.* 17, 863–869.
- Kangwansupamonkon, W., Lauruengtana, V., Surassmo, S., Ruktanonchai, U., 2009. Antibacterial effect of apatite-coated titanium dioxide for textile application. *Nanomedicine* 5, 240–249.
- Kantouch, A., El-Sayed, A., 2008. Polyvinyl pyridine metal complex as permanent antimicrobial finishing for viscose fabric. *Int. J. Biol. Macromol.* 43, 451–455.
- Karci, F., Şener, N., Yamaç, M., Şener, I., Demirçali, A., 2009. The synthesis, antimicrobial activity and absorption characteristics of some novel heterocyclic disazo dyes. *Dyes Pigments* 80, 47–52.
- Kawabata, A., Taylor, J.A., 2006. The effect of reactive dyes upon the uptake and antibacterial action of poly(hexamethylene biguanide) on cotton. Part 2: uptake of poly(hexamethylene biguanide) on cotton dyed with β -sulphatoethylsulphonyl reactive dyes. *Dyes Pigments* 68, 197–204.
- Kawabata, A., Taylor, J.A., 2007. The effect of reactive dyes upon the uptake and antibacterial action of poly(hexamethylene biguanide) on cotton. Part 3: reduction in the bactericidal efficacy of poly(hexamethylene biguanide) on cotton dyed with bis(monochlorotriazinyl) reactive dyes. *Carbohydr. Polym.* 67, 375–389.
- Ki, H.Y., Kim, J.H., Kwon, S.C., Jeong, S.H., 2007. Study of multifunctional wool textile treated with nano-sized silver. *J. Mater. Sci.* 42, 8020–8024.
- Kim, H.W., Kim, B.R., Rhee, Y.H., 2010. 'Imparting durable antimicrobial properties to cotton fabrics using alginate–quaternary ammonium complex nanoparticles'. *Carbohydr. Polym.* 79, 1057–1062.
- Kim, S., Choi, J.E., Choi, J., Chung, K.-H., Park, K., Yi, J., 2009. Oxidative stress-dependent toxicity of silver nanoparticles in human hepatoma cells. *Toxicol. In Vitro* 23, 1076–1084.
- Kim, T.-K., Son, Y.-A., 2005. 'Effect of reactive anionic agent on dyeing of cellulosic fibers with a Berberine colorant – Part 2: anionic agent treatment and antimicrobial activity of a Berberine dyeing'. *Dyes Pigments* 64, 85–89.
- Kim, Y.H., Choi, H.-M., Yoon, J.H., 1998. Synthesis of a quaternary ammonium derivative of chitosan and its application to a cotton antimicrobial finish. *Text. Res. J.* 68, 428–434.
- Kim, Y.H., Nam, C.W., Choi, J.W., Jang, J., 2003. Durable antimicrobial treatment of cotton fabrics using *N*-(2-hydroxy)propyl-3-trimethylammonium chitosan chloride and polycarboxylic acids. *J. Appl. Polym. Sci.* 88, 1567–1572.
- Kittinaovarat, S., Kantuptim, P., Singhaboonponp, T., 2006. Wrinkle resistant properties and antibacterial efficacy of cotton fabrics treated with glyoxal system and with combination of glyoxal and chitosan system. *J. Appl. Polym. Sci.* 100, 1372–1377.
- Klemenčič, D., Simončič, B., Tomšič, B., Orel, B., 2010. Biodegradation of silver functionalised cellulose fibres. *Carbohydr. Polym.* 80, 427–436.
- Koivula, M., Kymäläinen, H.-R., Virta, J., Hakkarainen, H., Hussein, T., Komulainen, J., Koponen, H., Hautala, M., Hämeri, K., Kanerva, P., Pehkonen, A., Sjöberg, A.-M., 2005. Emissions from thermal insulations. Part 2: evaluation of emission from organic and inorganic insulations. *Build. Environ.* 40, 803–814.
- Kolmos, H.J., Svendsen, R.N., Nielsen, S.V., 1997. The surgical team as a source of post-operative wound infection caused by *Streptococcus pyogenes*. *J. Hosp. Infect.* 35, 207–214.

- Korber, D.R., Choi, A., Wolfaardt, G.M., Ingham, S.C., Caldwell, D.E., 1997. Substratum topography influences susceptibility of *Salmonella enteritidis* biofilms to trisodium phosphate. *Appl. Environ. Microbiol.* 63, 3352–3358.
- Kostić, M., Radić, N., Obradović, B.M., Dimitrijević, S., Kuraica, M.M., Škundrić, P., 2008. Antimicrobial textile prepared by silver deposition on dielectric barrier discharge treated cotton/polyester fabric. *Chem. Ind. Chem. Eng. Q.* 14, 219–221.
- Kumar, V., Bhardwaj, Y.K., Rawat, K.P., Sabharwal, S., 2005. Radiation induced grafting of vinylbenzyltrimethylammonium chloride (VBT) onto cotton fabric and study of its antimicrobial activities. *Radiat. Phys. Chem.* 73, 175–182.
- Lankford, M.G., Collins, S., Youngberg, L., Rooney, D.M., Warren, J.R., Noskin, G.A., 2006. Assessment of materials commonly utilized in health care: implications for bacterial survival and transmission. *Am. J. Infect. Contr.* 34, 258–263.
- Larson, E., Aiello, A.E., 2006. Systematic risk assessment methods for the infection control professional. *Am. J. Infect. Contr.* 34, 323–326.
- Lee, H.J., Yeo, Y.S., Jeong, S.H., 2003. Antibacterial effect of nanosized silver colloidal solution on textile fabrics. *J. Mater. Sci.* 38, 2199–2204.
- Lee, J., Broughton, R.M., Akdag, A., Worley, S.D., Huang, T.S., 2007. Antimicrobial fibers created via polycarboxylic acid durable press finishing. *Text. Res. J.* 77, 604–611.
- Leonas, K.K., 1998. Effect of laundering on the barrier properties of reusable surgical gown fabrics. *Am. J. Infect. Contr.* 26, 495–501.
- Leonas, K.K., Jinkins, R.S., 1997. The relationship of selected fabric characteristics and the barrier effectiveness of surgical gown fabrics. *Am. J. Infect. Contr.* 25, 16–23.
- Leonas, K.K., Jones, C.R., 2003. The relationship of fabric properties and bacterial filtration efficiency for selected surgical face masks. *J. Text. Apparel Technol. Manag.* 3 (2). Available from: http://www.tx.ncsu.edu/jtatm/volume3issue2/Articles/Leonas/leonas_full_document.pdf.
- Li, Q., Chen, S.L., Jiang, W.C., 2007. Durability of nano ZnO antibacterial cotton fabric to sweat. *J. Appl. Polym. Sci.* 103, 412–416.
- Li, X., Feng, X., Yang, S., Fu, G., Wang, T., Su, Z., 2010. Chitosan kills *Escherichia coli* through damage to be of cell membrane mechanism. *Carbohydr. Polym.* 79, 493–499.
- Lim, S.H., Hudson, S.M., 2003. Review of chitosan and its derivatives as antimicrobial agents and their uses as textile chemicals. *J. Macromol. Sci. C Polym. Rev.* 43, 223–269.
- Lin, J., Qiu, S., Lewis, K., Klibanov, A.M., 2003. Mechanism of bactericidal and fungicidal activities of textiles covalently modified with alkylated polyethylenimine. *Biotechnol. Bioeng.* 83, 168–172.
- Lindsay, D., von Holy, A., 2006. Bacterial biofilms within the clinical setting: what healthcare professionals should know. *J. Hosp. Infect.* 64, 313–325.
- Lister, J., 1867. On a new method of treating compound fractures, abscesses, etc., with observations on the conditions of suppuration. *Lancet* 1, 326–9, 357–9, 387–9, 507–9; 2, 95–6. Available from: <http://www.answers.com/topic/joseph-lister-1st-baron-lister>.
- Liu, N., Chen, X.-G., Par, H.-J., Liu, C.-G., Liu, C.-S., Meng, X.-H., Yu, L.-J., 2006. Effect of MW and concentration of chitosan on antibacterial activity of *Escherichia coli*. *Carbohydr. Polym.* 64, 60–65.
- Liu, S., Ma, J., Zhao, D., 2007. Synthesis and characterization of cationic monoazo dyes incorporating quaternary ammonium salts. *Dyes Pigments* 75, 255–262.
- Liu, S., Sun, G., 2006. Durable and regenerable biocidal polymers: acyclic *N*-halamine cotton cellulose. *Ind. Eng. Chem. Res.* 45, 6477–6482.
- Liu, S., Sun, G., 2008a. The synthesis of novel cationic anthraquinone dyes with high potent antimicrobial activity. *Dyes Pigments* 77, 380–386.

- Liu, S., Sun, G., 2008b. Radical graft functional modification of cellulose with allyl monomers: chemistry and structure characterization. *Carbohydr. Polym.* 71, 614–625.
- Liu, S., Sun, G., 2009. The biocidal properties of anthraquinoid dyes. *Dyes Pigments* 81, 231–234.
- Liu, X.D., Nishi, N., Tokura, S., Sakairi, N., 2001. Chitosan coated cotton fiber: preparation and physical properties. *Carbohydr. Polym.* 44, 233–238.
- Luo, J., Sun, Y., 2006. Acyclic *N*-halamine-based fibrous materials: preparation, characterization, and biocidal functions. *J. Polym. Sci. A Polym. Chem.* 44, 3588–3600.
- Ma, M., Sun, Y., Sun, G., 2003. Antimicrobial cationic dyes. Part 1: synthesis and characterization. *Dyes Pigments* 58, 27–35.
- Mahlting, B., Fiedler, D., Böttcher, H., 2004. ‘Antimicrobial sol–gel coatings’. *J. Sol. Gel Sci. Technol.* 32, 219–222.
- Malato, S., Fernández-Ibáñez, P., Maldonado, M.I., Blanco, J., Gernjak, W., 2009. Decontamination and disinfection of water by solar photocatalysis: recent overview and trends. *Catal. Today* 147, 1–59.
- Malnick, S., Bardenstein, R., Huszar, M., Gabbay, J., Borkow, G., 2008. Pyjamas and sheets as a potential source of nosocomial pathogens. *J. Hosp. Infect.* 70, 89–92.
- Manian, F.A., Ponzillo, J.J., 2007. Compliance of routine use of gowns by healthcare workers (HCWs) and non HCW visitors on entry into the rooms patients under contact precautions. *Infect. Control Hosp. Epidemiol.* 28, 337–340.
- Meilert, K.T., Laub, D., Kiwi, J., 2005. Photocatalytic self-cleaning of modified cotton textiles by TiO₂ clusters attached by chemical spacers. *J. Mol. Catal. A Chem.* 237, 101–108.
- Merritt, K., An, Y.H., 2000. Factors influencing bacterial adhesion. In: An, Y.H., Friedman, R.J. (Eds.), *Handbook of Bacterial Adhesion: Principles, Methods and Applications*. Humana Press, Totowa, NJ, pp. 53–72.
- Meyer, B., 2003. Approaches to prevention, removal and killing of biofilms. *Int. Biodeterior. Biodegrad.* 51, 249–253.
- Morris, C.E., Vigo, T.L., Welch, C.M., 1981. Binding of organic antimicrobial agents to cotton fabric as zirconium complexes. *Text. Res. J.* 51, 91–96.
- Mucha, H., 2010. Hohenstein Laboratories, Personal Communication.
- Nagarajan, L., 2009. Herbal Finishing of Cotton Fabric for Antimicrobial Properties with *Ocimum Sanctum*. Available from: <http://www.fibre2fashion.com/industry-article/18/1759/herbal-finishing-of-cotton-fabric-for-antimicrobial-properties-withocimum-sanctum1.asp>.
- Nakashima, T., Sakagami, Y., Ito, H., Matsuo, M., 2001. Antibacterial activity of cellulose fabrics modified with metallic salts. *Text. Res. J.* 71, 688–694.
- NanoHorizons Inc, 2008. Nanohorizons’ Smart Silver Guards Wool Fabrics against Microbes that Cause Odor. Available from: <http://www.azonano.com/news.asp?NewsID=7080>.
- Neely, A.N., Maley, M.P., 2000. Survival of Enterococci and Staphylococci on hospital fabrics and plastic. *J. Clin. Microbiol.* 38, 724–726.
- Nel, A., Xia, T., Mädler, L., Li, N., 2006. Toxic potential of materials at the nanolevel. *Science* 111, 622–627.
- Newman, G.R., Walker, M., Hobot, J.A., Bowler, P.G., 2006. Visualisation of bacterial sequestration and bactericidal activity within Hydrofiber® wound dressings. *Biomaterials* 27, 1129–1139.
- Ni, M., Leung, M.K.H., Leung, D.Y.C., Sumathy, K., 2007. A review and recent developments in photocatalytic water-splitting using TiO₂ for hydrogen production. *Renew. Sustain. Energy Rev.* 11, 401–425.

- Nissen, L., Zatta, A., Stefanini, I., Grandi, S., Sgorbati, B., Biavati, B., Monti, A., 2010. Characterization and antimicrobial activity of essential oils of industrial hemp varieties (*Cannabis sativa* L.). *Fitoterapia* 81, 413–419.
- No, H.K., Park, N.Y., Lee, S.H., Meyers, S.P., 2002. Antibacterial activity of chitosans and chitosan oligomers with different molecular weights. *Int. J. Food Microbiol.* 74, 65–72.
- Park, P.J., Je, J.Y., Byun, H.G., Moon, S.H., Kim, S.E., 2004. Antimicrobial activity of hetero-chitosans and their oligosaccharides with different molecular weights. *J. Microbiol. Biotechnol.* 14, 317–323.
- Parvez, F.M., Jarvis, W.R., 1999. Nosocomial infections in the nursery. *Semin. Pediatr. Infect. Dis.* 10, 119–129.
- Perelshtein, I., Applerot, G., Perkas, N., Wehrschetz-Sigl, E., Hasmann, A., Guebitz, G.M., Gedanken, A., 2009. Antibacterial properties of an in situ generated and simultaneously deposited nanocrystalline ZnO on Fabrics. *Appl. Mater. Interfaces* 1, 361–366.
- Pillai, C.K.S., Paul, W., Sharma, C.P., 2009. Chitin and chitosan polymers: chemistry, solubility and fiber formation. *Prog. Polym. Sci.* 34, 641–678.
- Pillai, Z.S., Kamat, V.P., 2004. What factors control the size and shape of silver nanoparticles in the citrate ion reduction method? *J. Phys. Chem. B* 108, 945–951.
- Pittet, D., Hugonnet, S., Harbarth, S., Mouroug, P., Sauvan, V., Touveneau, S., 2000. Effectiveness of a hospital-wide programme to improve compliance with hand hygiene. *Lancet* 356, 1307–1312.
- Pozzo, R.L., Baltanás, M.A., Cassano, A.E., 1997. Supported titanium oxide as photocatalyst in water decontamination: state of the art. *Catal. Today* 39, 219–231.
- Pradeep, T., Anshup, 2009. Noble metal nanoparticles for water purification: a critical review. *Thin Solid Films* 517, 6441–6478.
- Purwar, R., Joshi, M., 2004. 'Recent developments in antimicrobial finishing of textiles — a review'. *AATCC Rev.* 4, 22–26.
- Puzniak, L.A., Gillespie, K.N., Leet, T., Kollef, M., Mundy, L.M., 2002. To gown or not to gown: the effect on acquisition of vancomycin resistant enterococci. *Clin. Infect. Dis.* 35, 18–25.
- Qian, L., Sun, G., 2004. Durable and regenerable antimicrobial textiles: improving efficacy and durability of biocidal functions. *J. Appl. Polym. Sci.* 91, 2588–2593.
- Qin, C., Li, H., Xiao, Q., Liu, Y., Zhu, J., Du, Y., 2006. Water-solubility of chitosan and its antimicrobial activity. *Carbohydr. Polym.* 63, 367–374.
- Rai, M., Yadav, A., Gade, A., 2009. Silver nanoparticles as a new generation of antimicrobials. *Biotechnol. Adv.* 27, 76–83.
- Ramachandran, T., Rajendrakumar, K., Rajendran, R., 2004. Antimicrobial textiles — an overview. *Differentiation* 84, 42–47. Available from: <http://www.icindia.org/publish/tx/0204/feb04tx4.pdf>.
- Ramos, R., Domingues, L., Gama, M., 2010. *Escherichia coli* expression and purification of LL37 fused to a family III carbohydrate-binding module from *Clostridium thermocellum*. *Protein Expr. Purif.* 71, 1–7.
- Ranjbar-Mohammadi, M., Aramia, M., Bahrami, H., Mazaheri, F., Mahmoodi, N.M., 2010. Grafting of chitosan as a biopolymer onto wool fabric using anhydride bridge and its antibacterial property. *Colloids Surfaces B Biointerfaces* 76, 397–403.
- Reijnders, L., 2006. Cleaner nanotechnology and hazard reduction of manufactured nanoparticles. *J. Clean. Prod.* 14, 124–133.
- Ren, X., Akdag, A., Kocer, H.B., Worley, S.D., Broughton, R.M., Huang, T.S., 2009a. *N*-Halamine-coated cotton for antimicrobial and detoxification applications. *Carbohydr. Polym.* 78, 220–226.

- Ren, X., Kocer, H.B., Worley, S.D., Broughton, R.M., Huang, T.S., 2009b. Rechargeable biocidal cellulose: synthesis and application of 3-(2,3-dihydroxypropyl)-5,5-dimethylimidazolidine-2,4-dione. *Carbohydr. Polym.* 75, 683–687.
- Rigby, J.A., Anand, S.C., 2000. Medical textiles. In: Horrocks, A.R., Anand, S.C. (Eds.), *Handbook of Technical Textiles*. Woodhead Publishing, Cambridge, pp. 407–424.
- Rinaudo, M., 2006. Chitin and chitosan: properties and applications. *Prog. Polym. Sci.* 31, 603–632.
- Rosenthal, V.D., Guzman, S., Safdar, N., 2005. Reduction in nosocomial infection with improved hand hygiene in intensive care units of a tertiary care hospital in Argentina. *Am. J. Infect. Contr.* 33, 392–397.
- Saarela, M., Alakomi, H.-L., Siuhko, M.-L., Maunuksela, L., Raaska, L., Mattila-Sandholm, T., 2004. Heterotrophic microorganisms in air and biofilm samples from Roman catacombs, with special emphasis on actinobacteria and fungi. *Int. Biodeterior. Biodegrad.* 54, 27–37.
- Saji, M., Taguchi, S., Uchiyama, K., Osono, E., Hayama, N., Ohkuni, H., 1995. Efficacy of Gentian-violet in the eradication of methicillin-resistant *Staphylococcus aureus* from skin lesions. *J. Hosp. Infect.* 31, 225–228.
- Sanpui, P., Murugadoss, A., Durga Prasad, P.V., Sankar Ghosh, S., Chattapadhyay, A., 2008. The antibacterial properties of a novel chitosan-Ag-nanoparticle composite. *Int. J. Food Microbiol.* 124, 142–146.
- Sayed, A.Z., El-Gaby, M.S.A., 2001. Synthesis of novel dyestuffs containing sulphonamido moieties and their application on wool and polyamide fibres. *Color. Technol.* 117, 293–297.
- Seong, H.-S., Whang, H.S., Ko, S.W., 2000. Synthesis of a quaternary ammonium derivative of chito-oligosaccharide as antimicrobial agent for cellulosic fibers. *J. Appl. Polym. Sci.* 76, 2009–15.
- Shao, H., Jiang, L., Meng, W.D., Qing, F.-L., 2003. Synthesis and antimicrobial activity of a perfluoroalkyl-containing quaternary ammonium salt. *J. Fluorine Chem.* 124, 89–91.
- Sheeba, J.M., Thambidurai, S., 2009. Extraction, characterization, and application of seaweed nanoparticles on cotton fabrics. *J. Appl. Polym. Sci.* 113, 2287–2292.
- Shin, Y., Yoo, D.I., Jang, J., 2001. Molecular weight effect on antimicrobial activity of chitosan treated cotton fabrics. *J. Appl. Polym. Sci.* 80, 2495–2501.
- Shiomori, T., Miyamoto, H., Makishima, K., Yoshida, M., Fujiyoshi, T., Udaka, T., Inaba, T., Hiraki, N., 2002. Evaluation of bedmaking-related airborne and surface methicillin-resistant *Staphylococcus aureus* contamination. *J. Hosp. Infect.* 50, 30–35.
- Silva, C., Kim, S.Y., Matamá, T., Padrão, J., Cavaco-Paulo, A., 2009. Enzymatic grafting of chitosan onto flax fabrics. In: *Proceedings of the 6th International Conference on Textile and Polymer Biotechnology*. Ghent, Belgium, pp. 83–88.
- Silvestri, L., Lenhart, F.P., Fox, M.A., 2001. Management of infections in the critically ill: prevention of intensive care unit infections. *Curr. Anaesth. Crit. Care* 12, 34–40.
- Singh, R., Jain, A., Panwar, S., Gupta, D., Khare, S.K., 2005. Antimicrobial activity of some natural dyes. *Dyes Pigments* 66, 99–102.
- Sivakumar, P.M., Balaji, S., Prabhawathi, V., Neelakandan, R., Manoharan, P.T., Doble, M., 2010. Effective antibacterial adhesive coating on cotton fabric using ZnO nanorods and chalcone. *Carbohydr. Polym.* 79, 717–723.
- Son, Y.-A., Kim, B.-S., Ravikumar, K., Lee, S.-G., 2006. 'Imparting durable antimicrobial properties to cotton fabrics using quaternary ammonium salts through 4-aminobenzenesulfonic acid-chloro-triazine adduct'. *Eur. Polym. J.* 42, 3059–3067.
- Struelens, M.J., Denis, O., Rodriguez-Villalobos, H., 2004. Microbiology of nosocomial infections: progress and challenges. *Microb. Infect.* 6, 1043–1048.

- Sun, Y., Sun, G., 2002. Durable and regenerable antimicrobial textile materials prepared by a continuous grafting process. *J. Appl. Polym. Sci.* 84, 1592–1599.
- Szostak-Kotowa, J., 2004. Biodeterioration of textiles. *Int. Biodeterior. Biodegrad.* 53, 165–170.
- Takashima, M., Shirai, F., Sageshima, M., Ikeda, N., Okamoto, Y., Dohi, Y., 2004. Distinctive bacteria-binding property of cloth materials. *Am. J. Infect. Contr.* 32, 27–30.
- Thomas, M., Montenegro, D., Castaño, A., Friedman, L., Leb, J., Huang, M.L., Rothman, L., Lee, H., Capodiferro, C., Ambinder, D., Cere, E., Galante, J., Rizzo, J.L., Melkonian, K., Engle, R., 2009. Polycations. 17. Synthesis and properties of polycationic derivatives of carbohydrates. *Carbohydr. Res.* 344, 1620–1627.
- Tolaymat, T.M., Badawy, A.M., Genaidy, A., Schekel, K.G., Luxton, T.P., Siudan, M., 2010. An evidence-based environmental perspective of manufactured silver nanoparticles in syntheses and applications: a systematic review and critical appraisal of peer-reviewed scientific papers. *Sci. Total Environ.* 408, 999–1006.
- Tomšič, B., Simončič, B., Orel, B., Cerne, L., Forte Tavcer, P., Zorko, M., Jerman, I., Vilcnik, A., Kovac, J., 2008. Sol-gel coating of cellulose fibres with antimicrobial and repellent properties. *J. Sol. Gel Sci. Technol.* 47, 44–57.
- Tomšič, B., Simončič, B., Orel, B., Žerjav, M., Schroers, H., Simončič, A., Samardžija, Z., 2009. Antimicrobial activity of AgCl embedded in a silica matrix on cotton fabric. *Carbohydr. Polym.* 75, 618–626.
- Toshima, Y., Ojima, M., Yamada, H., Mori, H., Tonomura, M., Hioki, Y., Koya, E., 2001. Observation of everyday hand-washing behavior of Japanese, and effects of antibacterial soap. *Int. J. Food Microbiol.* 68, 83–91.
- Towner, K.J., 2009. Acinetobacter: an old friend, but a new enemy. *J. Hosp. Infect.* 73, 355–363.
- Trillis III, F., Eckstein, E.C., Budavich, R., Pultz, M.J., Donskey, C.J., 2008. Contamination of hospital curtains with healthcare-associated pathogens. *Infect. Control Hosp. Epidemiol.* 29, 1074–1076.
- Tsukada, M., Katoh, H., Wilson, D., Shin, B.-S., Arai, T., Murakami, R., Freddi, G., 2002. Production of antimicrobially active silk proteins by use of metal-containing dyestuffs. *J. Appl. Polym. Sci.* 86, 1181–1188.
- Tsukada, M., Arai, T., Colonna, G.M., Boschi, A., Freddi, G., 2003. Preparation of metal-containing protein fibers and their antimicrobial properties. *J. Appl. Polym. Sci.* 89, 638–644.
- Tung, W.S., Daoud, W.A., 2009. Photocatalytic self-cleaning keratins: a feasibility study. *Acta Biomater.* 5, 50–56.
- Unger, C., Lück, P.C., 2007. Silver coated textiles reduce the contamination in water systems. *Int. J. Med. Microbiol.* 297, 64.
- Vaideki, K., Jayakumar, S., Thilagavathi, G., Rajendran, R., 2007. A study on the antimicrobial efficacy of RF oxygen plasma and neem extract treated cotton fabrics. *Appl. Surf. Sci.* 253, 7323–7329.
- Vaideki, K., Jayakumar, S., Rajendran, R., Thilagavathi, G., 2008. Investigation on the effect of RF air plasma and neem leaf extract treatment on the surface modification and antimicrobial activity of cotton fabric. *Appl. Surf. Sci.* 254, 2472–2478.
- Vaidyanathan, R., Kaliswaralal, K., Gopalram, S., Gurunathan, S., 2009. Nanosilver: the burgeoning therapeutic molecule and its green synthesis. *Biotechnol. Adv.* 27, 924–937.
- Van Loosdrecht, M.C.M., Lyklema, W., Norde, W., Zehnder, A.J.B., 1990. Influences of interfaces on microbial activity. *Microbiol. Mol. Biol. Rev.* 54, 75–87.

- Vandenbroucke-Grauls, C.M.J.E., 2000. Clean hands closer to the bedside. *Lancet* 356, 1291–1292.
- Vigneshwaran, N., Kumar, S., Kathe, A.A., Varadarajan, P.V., Prasad, V., 2006. Functional finishing of cotton fabrics using zinc oxide-soluble starch nanocomposites. *Nanotechnology* 17, 5087–5095.
- Vigneshwaran, N., Kathe, A.A., Varadarajan, P.V., Nachane, R.P., Balasubramanya, R.H., 2007. Functional finishing of cotton fabrics using silver nanoparticles. *J. Nanosci. Nanotechnol.* 7, 1893–1897.
- Vigo, T.L., 1994. Protective clothing effective against biohazards. In: Raheel, M. (Ed.), *Protective Clothing Systems and Materials*. Marcel Dekker, New York, pp. 225–243.
- Wainwright, M., 2008. Dyes in the development of drugs and pharmaceuticals. *Dyes Pigments* 76, 582–589.
- Wang, Q., Zhang, N., Hu, X., Yang, J., Du, Y., 2007. Chitosan/starch fibers and their properties for drug release. *Eur. J. Pharm. Biopharm.* 66, 398–404.
- Wang, Q., Fan, X., Hu, Y., Yuan, J., Cui, L., Wang, P., 2009. Antibacterial functionalization of wool fabric via immobilizing lysozymes. *Bioprocess Byosystems Eng.* 32, 633–639.
- Wang, R., Xin, J.H., Tao, X.M., Daoud, W.A., 2004. ZnO nanorods grown on cotton fabrics at low temperature. *Chem. Phys. Lett.* 398, 250–255.
- Wang, X., Du, Y., Fan, L., Liu, H., Hu, Y., 2005. 'Chitosan–metal complexes as antimicrobial agent: synthesis, characterization and structure-activity study'. *Polym. Bull.* 55, 105–113.
- Wasif, A.I., Laga, S.K., 2009. Use of nano silver as antimicrobial agent for cotton. *Autex Res. J.* 9, 5–13. Available from: <http://www.autexrj.org>.
- Webb, J.S., Givskov, M., Kjelleberg, S., 2003. Bacterial biofilms: prokaryotic adventures in multicellularity. *Curr. Opin. Microbiol.* 6, 578–585.
- Wilson, J.A., Loveday, H.P., Hoffman, P.N., Pratt, R.J., 2007. Uniform: an evidence review of the microbiological significance of uniforms and uniform policy in the prevention and control of healthcare-associated infections. Report to the Department of Health (England). *J. Hosp. Infect.* 66, 301–307.
- Wollina, U., Heide, M., Müller-Litz, W., Obenauf, D., Ash, J., 2003. Functional textiles in prevention of chronic wounds, wound healing and tissue engineering. In: Elsner, P., Hatch, K., Wigger-Alberti, W. (Eds.), *Textiles and the Skin: Current Problems in Dermatology*, vol. 31. Karger, Basel, pp. 82–97. Available from: <http://www.karger.com/gazette/67/elsner/wollina.pdf>.
- Wollina, U., Abdel-Naser, M.B., Verma, S., 2006. Skin physiology and textiles: consideration of basic interactions. In: Hipler, U.-C., Elsner, P. (Eds.), *Biofunctional Textiles and the Skin: Current Problems in Dermatology*, vol. 33. Karger, Basel, pp. 1–16. Available from: <http://content.karger.com/ProdukteDB/produkte.asp?Doi=93926>.
- Xing, Y., Yang, X., Dai, J., 2007. Antimicrobial finishing of cotton textile based on water glass by sol-gel method. *J. Sol. Gel Sci. Technol.* 43, 187–192.
- Yadav, A., Prasad, V., Kathe, A.A., Raj, S., Yadav, D., Sundaramoorthy, C., Vigneshwaran, N., 2006. Functional finishing in cotton fabrics using zinc oxide nanoparticles. *Bull. Mater. Sci.* 29, 641–645.
- Yang, C.L., Kim, Y.K., Scarano, F., Lewis, A.F., Laoulache, R.N., Sun, Y., 2009. Fiber-based bioreactor media for air pollution control. NTC project: F08-MD02. Available from: <http://www.ntcresearch.org/pdf-rpts/AnRp09/F08-MD02-A9.pdf>.
- Yang, H.-C., Wang, W.H., Huang, K.-S., Hon, M.-H., 2010. Preparation and application of nanochitosan to finishing treatment with anti-microbial and anti-shrinking properties. *Carbohydr. Polym.* 79, 176–179.

- Ye, W., Leung, M.F., Xin, J., Kwong, T.L., Lee, D.K.L., Li, P., 2005. Novel core-shell particles with poly (n-butyl acrylate) cores and chitosan shells as an antibacterial coating for textiles. *Polymer* 46, 10538–10543.
- Ye, W., Xin, J.H., Li, P., Lee, K.L.D., Kwong, T.L., 2006. Durable antibacterial finish on cotton fabric by using chitosan-based polymeric core-shell particles. *J. Appl. Polym. Sci.* 102, 1787–1793.
- Yuranova, T., Rincon, A.G., Pulgarin, C., Laub, D., Xantopoulos, N., Mathieu, H.-J., Kiwi, J., 2006. Performance and characterization of Ag-cotton and Ag/TiO₂ loaded textiles during the abatement of *E. coli*. *J. Photochem. Photobiol. A Chem.* 181, 363–369.
- Zhang, F., Zhang, D., Chen, Y., Lin, H., 2009. The antimicrobial activity of the cotton fabric grafted with an amino-terminated hyperbranched polymer. *Cellulose* 16, 281–288.
- Zhang, Z., Chen, L., Ji, J., Huang, Y., Chen, D., 2003. Antibacterial properties of cotton fabrics treated with chitosan. *Text. Res. J.* 73, 1103–1106.

Further reading

- Semmelweis, I.P., 1861. *Die Ätiologie, der Begriff und die Prophylaxis des Kindbettfiebers*. Pest, Wien, Leipzig (Hartleben).

This page intentionally left blank

Biomimetics and textile materials

21

Michael S. Ellison

Clemson University, Clemson, South Carolina, United States

21.1 Introduction

21.1.1 *Motivation for looking at nature as a model for textile materials*

Throughout time, nature has instructed us in many ways, and from her instruction, we have learned to improve what we have found. We study moon phases to set times to plant crops and to breed livestock. We use programmatic breeding of plants and of animals to enhance those properties we deem most beneficial to our needs. We choose natural materials suitable for shelter and implements. Depending on their properties, we combine those materials to enhance their utility: stone and clay, early; wood, always; copper, iron and bronze, later; animal hides and furs and their fibres and plants and their fibres. As we use these natural materials, in each instance, we learn nature's secrets and modify our uses according to nature's lessons. In as much as this book deals with fibrous materials, and natural fibres specifically, discussion of other nonfibrous materials will be limited. However, in this introduction, mention of such materials and of applications beyond fibres and textiles will be made so as to appreciate the full scope of biomimesis.

As our tools of inquiry have become more sophisticated, we have learned more of nature's secrets and how to put that knowledge to use; greater understanding has inspired major advances in the new age of textile fibres. For example, in the mid-19th century, the discovery of the solubility of nitrocellulose in simple solvents (e.g., acetone) allowed the production of synthetically derived fibres, heralding an early biomimicry event: humankind was no longer strictly limited to the use of naturally produced fibre materials but was capable of producing novel fibres not present in nature. We will revisit this landmark discovery, and others, later in the chapter.

An early review of the properties of nature's materials, from the viewpoint of the mechanical engineer (Jeronimidis and Atkins, 1995), provides substantial intellectual content for use when contemplating how to make new materials based on natural systems. In that work, the authors compare many of the standard practices and paradigms of engineering with development of structural components in nature. For example, an engineering study of biological materials uncovers the integration and optimization conducted by nature from the molecular level up to the ultimate structural components. This study can illuminate what is needed at each level, so that the final material functions as required as the end product; the constraint in natural systems is that this optimized and integrated material is produced with the minimum metabolic

effort. A similar principle, if applied in engineering design, would be sustainable manufacturing.

Several specific examples are included in that review article. For example, they report on a study of the effect of turgor pressure, that is, the internal fluid pressure in cells of biological materials, which acts to prestress the cell, on dandelion stems. Exposing dandelion stems to a sugar water solution causes the stems to wilt owing to a drop in the turgor pressure. The experiments showed that there is a drop in bending stiffness EI (E is Young's modulus, I is the second moment of area of the cross section) with increasing sugar concentration, with minimal change in the tensile modulus E . The stem structure, which is hollow, comprises a series of tubular cells with long axis parallel to the stem axis. A textile material composed of an annulus of hollow fibres may be able to replicate this action in a man-made structure.

For examples of fibrous assemblies for which nature has been our mentor, we have only to consider wool felt and animal furs. As the story goes, wool felt was first produced by the action and moisture present in sandals of men walking in the desert. Felted products from a multitude of fibres are now manufactured using needle-punch nonwoven manufacturing processes and other types of processes. The production of synthetic furs based on the study of natural furs is another good example, one we shall return to later.

21.1.1.1 Apparel and other coverings

As our skin lost its native hair, protective covering from environmental elements became necessary. Prehistoric humans fashioned clothing with available biological materials that required relatively little preparation. Depending on geographic location, animal skins and furs such as those from wolves, bears, deer, moose and leopard were easily converted to garment materials. Following the experience with animal skin fibres (hair and fur), the discovery of plant fibres led to the production of fabrics from cellulose materials. That conversion of plant fibres so as to enable their use as a mimic of an existing article may be considered an early application of biomimesis. What undoubtedly had its genesis as a purely manual process eventually led to the development of machines to aid in the conversion. The process of selection and harvesting, cleaning and preparation, twisting the fibres into yarns and finally weaving the yarns into a fabric was very labour intensive. As is well documented by textiles historians, mechanization of these processes led to the industrial revolution. It is easy to project a similar impact from the development of biomimesis.

21.1.1.2 Architectural and other built environment flexible materials

Need for shelter from the elements led to the building of structures. Based on observations in nature, early builders used available materials such as mud and plant straw to construct cavelike huts, incorporating ventilation shafts and multiple openings. As needed, outer surfaces were toughened and made water resistant. Eventually, living spaces were made more secure and comfortable. Of particular current interest is the

use of termite mound environmental control in modern buildings, as discussed in [Section 15.2.2](#). Today, fibre-based materials are used extensively in home and commercial construction, a continuation of early man's efforts to fabricate shelter from the elements using similar fibre-based materials.

This chapter aims to provide the reader with some thoughts and references on the use of natural fibres and fibrous materials as models for biomimetic design of textile materials. As the previous paragraphs demonstrate, the field is open and ripe for development. It is the writer's hope that this chapter will stimulate additional developments in this important field.

21.2 Key principles of biomimesis

The key principle of biomimesis is quite simple: employ biology as inspiration and guide in the development of new materials. There are processes in natural systems that may be used as models for advancement of science and engineering. Detailed study of systems and organisms within those systems is required. However, study by and of itself will not lead to biomimetic inspirations. One must recognize that while nature is our ultimate teacher, the study of biology must be predicated on discovery of structure and function that can be used, when tempered with engineering realities, in appropriate synthetic scenarios. The importance of biomimicry as a discovery process is that natural processes are inherently sustainable and efficient in their utilization of resources; as it is becoming increasingly apparent, this is a critical issue.

21.2.1 Introduction to biomimetics

The field of biomimetics has experienced a rapid evolution, and there are several sources of information on the topic. Janine Benyus discusses biomimicry as having three primary components ([Benyus, 2002](#)):

- Nature as model: new solutions to human problems.
- Nature as measure: ecology/evolution as standard of what works.
- Nature as mentor: learn from nature, not take from nature.

Her view of natural systems as a model source for finding solutions to problems is predicated on an active study of what nature presents and focused on what solutions nature employs. Nature is thus viewed as a mentor and not simply as a resource to exploit. Thus, we are directed to use nature to assess the viability of our solution. When considered in the context of sustainability, the standard is high.

Borrowing from the NRC report 'Inspired by Biology', we find the following definitions ([National Research Council \(US\), 2008](#)):

Biomimicry: learning the mechanistic principle of a natural function and then trying to achieve that function in a synthetic material.

Bioinspiration: from observing a particular task performed by a natural system, gain inspiration for a synthetic system to effect the same task.

Bioderivation: hybrid between natural and synthetic materials and functions.

Molecular biology, an extremely interesting and fruitful field, is one of the newest resources for studying and mimicking nature. The study of recombinant deoxyribonucleic acid (DNA), together with information learned from amino acid (AA) analysis and from nucleic acid chemistry, has provided researchers new tools with which to study nature's materials, to mimic them and to make new ones.

From thoughtful observation and consideration of how nature produces her fantastic materials (e.g., silks from various spiders and insects are remarkable materials produced under environmentally benign conditions), we find there is still much to learn about using nature's models of sustainable manufacturing in our own manufacturing of mimicked materials. Clearly, this is an important area to study and emulate, one that we will address in more detail further in this chapter.

21.2.2 Design and function in natural systems

A study by Hes (Hes, 2009) demonstrated the importance of several fibre and structural features important to the functioning of animal furs. As expected, the overall thickness of a fur determines the thermal resistance. However, it was also found that the ratio of the hair diameter to the hair length is a parameter critical to the efficacy of the fur as an insulator. An overreaching aspect of the hair itself, however, is whether it is solid or hollow. For example, the fur of the arctic silver fox is hollow, but chambered, precluding even low values of heat conduction. Other animals, notably the polar bear, have hollow fibres in their furs (Bhushan, 2009). Regarding the use of these hair as a model for optical fibres and heat pipes see also Bahners et al. (2008) and Koon (1998).

Another example of design and function in natural systems, one very germane to the present chapter, is spider dragline silk. The review article by Lydon (Lydon, 2004) provides a rich overview of the history and the science of silk. In terms of design and function, silks hold a preeminent position in structure property studies of fibres. Being proteins, comprising multiple AAs in fairly well-characterized sequences, these materials have much to offer as models. While the AA sequence at the molecular level, the primary structure, defines the possibilities for higher order structures, it is the hierarchical secondary and tertiary structures that have been proposed to account for the remarkable properties. Two examples thought to contribute at the molecular level to the elasticity of the fibres, which account for their remarkable toughness, are that of the helical coiled structures and the betasheet crystals taken by the protein chains (Hayashi et al., 1999).

For spiders, the use of silk to catch prey was developed during their 400 million years or so of evolution (Foelix, 1996). For orb-weaving arachnids, both the orb web structure and the spider silks themselves have undergone strenuous optimizing selection for toughness and controlled elasticity so as to ensure successful capture of prey (Vollrath and Knight, 2001). On the other hand, insect silks, such as moth silks, must be used to build a strong yet soft cocoon in which to protect the caterpillar as it morphs into the moth or butterfly (Fedic et al., 2003). For such a structure, the fibres must be combined into a strong composite for which the durability of the casing is more important than is the toughness of the fibre itself (Zhao et al., 2005). We will return to silk later in the chapter, as a model for synthetic fibres that mimic natural ones.

Most exoskeletal structures found in nature are multilayered composites. The shell of *Crysmallon squamiferum*, a gastropod mollusk living near deep-sea hydrothermal vents, comprises a soft organic matrix secreted by the snail but further employs an outermost layer of nanoparticles of iron sulphide from the hydrothermal vents. The design is such that, when hit, the shell cracks in a way that absorbs energy without catastrophic failure: the cracks will be deflected by the iron sulfide particles, preventing formation of larger cracks. Furthermore, the iron sulphide particles act as armour against attack by crab claws. Another component in the composite, a thick energy-absorbing middle layer, acts to further dissipate the energy of a blow. This helps to protect the brittle inner shell, which is made of calcium carbonate (Yao et al., 2010). The goal of biomimicry in this case is to exploit our knowledge of this, and other, protective structures found in nature to improve our own protective materials.

Mother of pearl, or nacre, the inner lining of the shells of abalone, mussels and certain other mollusks, is 95% aragonite (calcium carbonate); the remainder of nacre comprises soft organic molecules. In spite of being predominantly calcium carbonate, nacre is many times more resistant to fracture than is aragonite. The remarkable strength of nacre results from a structural architecture with multiple length scales, ranging from nanometres to micrometres. Through a processing technique involving freezing of imbibed seawater, researchers formed a ceramic that was four times stronger than artificial bone. When seawater freezes, ice crystals form a scaffolding of thin layers of pure ice separated by impurities, such as salt and microorganisms. The resulting architecture roughly resembles that of nacre. Such innovation based on biological observation is another example of a new era in materials science, and with advances in molecular biology, production of these and other remarkable materials by cellular processes will become possible (Munch et al., 2008).

Architects, inspired by termite mounds that possess an intrinsic ventilation system, have utilized similar designs in low-rise buildings. In a sense, many of these termite mounds are not passive in that the termites actively open and close openings in response to environmental changes (Doan, 2007). In other cases, there is a response of the clay to moisture, in that the clay expands as its moisture content increases. This swelling of the clay will decrease the permeability of the mound, limiting the ventilation. As the sun dries out the clay, the permeability, and hence ventilation, will increase (Mehta, 2006).

21.2.3 Biologically inspired design and function in human systems

Lotus leaves are clean and remain that way without intervention by an outside entity other than rainfall. The surface of the leaves is of such a construction that contaminants are readily picked up by water when it rains and carried from the surface. The surface is composed of a series of protuberances of controlled size and surface morphology (Fig. 21.1; Bhushan, 2009). This natural design has been used to produce self-cleaning paint (Dendl and Interwies, 2001) and fabrics (Gao and McCarthy, 2006).

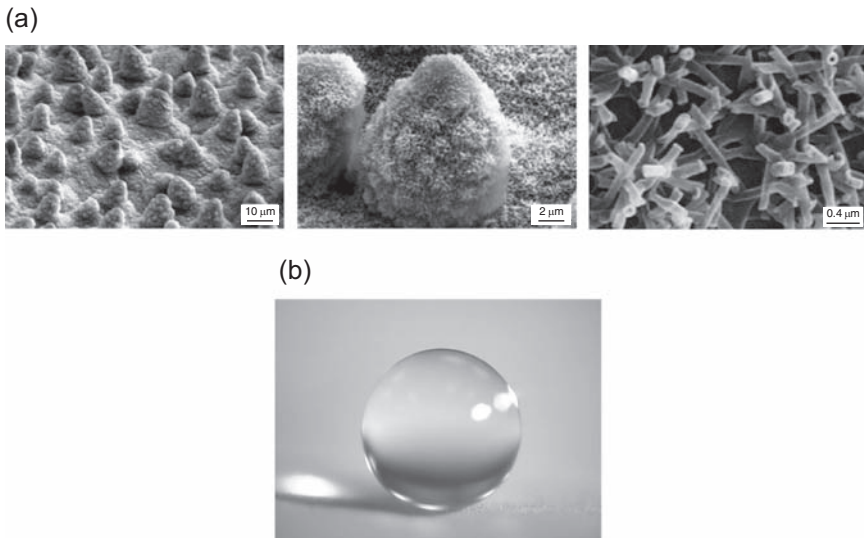

Figure 21.1 (a) Scanning electron microscopy (SEM) micrographs (shown at three magnifications) of lotus (*Nelumbo nucifera*) leaf surface, showing the microstructure formed by papillose epidermal cells covered with epicuticular wax tubules. (b) Image of water droplet sitting on the lotus leaf.

Rapid prototyping processes, using multiple materials for the fabrication of bioinspired robot structures, have been developed (Cutkosky and Kim, 2009). These structures are designed to include materials that are at once both stiff and compliant, thus presenting many of the properties of natural appendages. These materials also have in situ sensors, allowing for easier control when compared with conventional robots.

21.3 Key principles and issues of biomimetic inspired textiles

21.3.1 Biomimetic inspired textiles using synthetic fibres

Some recent research focused on development of deployable wet-responsive fibrous materials to imitate the effect of spontaneous unfolding of tree leaves (Kornev, 2009). This study was a demonstration of an application of superabsorbency, in which the physicochemical energy of wetting is converted into mechanical energy to effect fabric bending. This was accomplished by incorporating nanofibers of alginate, a natural biopolymer extracted from seaweed, between fabric layers, and using Miura-ori origami-like structures. Alginate gels on cross-linking with calcium chloride; when wetted, the alginate layer swells leading to order-of-magnitudes changes in elastic properties. One result of this work is a scroll that unrolls itself on wetting.

Researchers at Clemson University have explored several ways to obtain a superhydrophobic fabric based on the 'lotus' effect. Employing a combination of a grafted layer of a hydrophobic polymer (low surface energy component) and nanoparticles (the roughness initiation component), they obtained a textile material that presented a very high resistance to wetting by water. In another attempt to create the lotus effect on a fabric surface, they studied the deposition of both polystyrene (PS) and triblock copolymer polystyrene- β -(ethylene-co-butylene)- β -styrene (SEBS) simultaneously on a model substrate. The PS component was then extracted by employing ethyl acetate, which acts as a solvent for PS and as a nonsolvent for SEBS. The dissolution of PS created a porous hydrophobic rough surface on the substrate. This method of surface modification was applied to a polyester fabric and resulted in a practically nonwetable textile material (Luzinov, 2006; Ramaratnam et al., 2008).

Researchers in the Advanced Fibre-Based Materials (AFBM) Center of Economic Excellence at Clemson University have developed fibres that mimic the colouration process that is used by the natural world, from butterfly wings to beetle backs. Those materials display colour by the interference of white light reflected from several layers in each fibre. This has resulted in a fibre that changes colour with viewing angle, without the use of dyes (Brown, 2007; personal communication).

Other research in the AFBM Center, inspired by materials in the natural world that have controlled liquid propagation, has led to selective-wicking fabrics, which are materials that can be used as very specific diagnostic tools. These fabrics use fibres with deep channels running the length of the fibre. The fabric is made from more than one type of fibre/yarn so that a single swatch can be used to test for different chemicals present in the body (Hirt, 2004).

21.3.2 Biomimetic inspired textiles using natural fibres

Discovery of manufacturing processes for rayon (regenerated cellulose) marked an early foray into biomimesis in the fibre arena. Although that discovery illustrates that humankind was no longer strictly limited to the use of naturally produced fibrous material, but was capable of producing novel fibres not present in nature, commercial viability of those fibres was limited because nitrocellulose (guncotton) was highly flammable.

By the late 19th century, the method for the production of cuprammonium rayon was discovered. Made from cellulose, cuprammonium rayon was touted as the man-made replacement for silk. With subsequent developments, many other methods for understanding the physics and chemistry of converting natural sources into cellulose were developed.

Chitin, a polysaccharide found in the outer skeleton of insects, crabs, shrimps and lobsters, and in the internal structures of other invertebrates, is such an example. Subsequent applications using chitin in fibres and textiles have been explored recently (Biqiong Chen, 2005; Lim and Hudson, 2004a,b). The remarkable toughness of nacre, the inner lining of mollusk shells, has been studied in designing tough composite materials (Munch et al., 2008; Tomsia, 2009).

21.3.3 Synthetic natural fibres via molecular biology

Biological systems synthesize structural protein polymer chains in which molecular weight, stereochemistry and AA composition and sequence are precisely specified by the genetic code. These structural proteins are the basic components of biomaterials including hair, tendon, cartilage, skin arteries and muscles of mammals and in the cuticles and silks of many arthropods such as insects and arachnids. The individual proteins making up these materials are of a particular sequence, and they often have specific AA motifs in common. These fibrous (structural) proteins have the ability to self-assemble into molecular networks. These molecular networks are usually insoluble in water due to cross-linking, hydrophobic interactions, hydrogen bonding and/or other weak interactions. Although the molecular architecture (sequence and composition) of the individual proteins in these molecular networks can be readily determined, the interactions between the structural protein molecules are not well understood. However, it is well recognized that the individual protein sequences ultimately control the physical properties of the molecular network.

One of the current major focuses in biology is the discovery, study and manipulation of bio-based materials. With the advent of recombinant DNA technology, it is now possible to produce proteins with specific AA sequences designed for a particular purpose. This ability to design proteins through the application of recombinant DNA technology has been used to produce novel materials, primarily in fibre and film applications. These so-called 'bioinspired' or 'biomimetic' materials hold great promise to contribute to materials science. However, another important application of recombinant DNA technology is to fully utilize these novel engineered proteins as probes of the relationship between structure, process and function in fibre and film materials.

Bio-based polymers display a broad range of incredible mechanical properties, are produced under environmentally innocuous conditions and are biodegradable. For this reason, the possibility of producing new bio-based materials engineered to have desired mechanical properties by mimicking natural processes is currently on the cutting edge of materials science research. To achieve this goal of controlled assembly of proteins into useful materials, both the architecture of the constituent molecules and the processes for their assembly into supramolecular structures need to be fully understood. Natural systems employ genes that specify specific proteins composed of specific structural and functional elements; hence, recombinant DNA technology allows development of the desired specific molecular architectures. Natural systems are limited in the way that the materials' properties are derived (i.e., gene-specific proteins matched to specific processing and production systems). Furthermore, an individual organism has little ability to modify material production (e.g., genetic sequence) in its lifetime. Unlike natural systems, recombinant DNA technologies allow us to explore a myriad of combinations of protein structural elements and to match them with a diverse number of potential processing and production methods. Thus, we have much greater possibilities to explore and generate novel materials using components of natural systems coupled with molecular engineering technologies.

The silks and silk/collagenlike structures produced by arthropods and mollusks are excellent model materials for study of the relationship between the structures formed

by the individual repetitive motifs present in the constituent proteins and the observed properties of the resulting fibre. In addition, because these materials have common protein features, yet are assembled into materials through different processes (spinnerets and injection moulding, respectively), they offer the possibility to compare processing and material production systems with final material properties. At Clemson University, we have engineered genes to produce both spider silk mimics and utilized these to produce mussel byssus thread mimics that are a combination of motifs from spider silk and collagen. The primary structure of the two highly repetitive two protein components of the dragline silk, called MA_{sp1} and MA_{sp2} (major ampullate spidroin 1 and 2), basically consists of alanine motifs in between glycine-rich (MA_{sp1}) or proline containing glycine-rich regions (MA_{sp2}). The alanine regions are purported to adopt antiparallel β sheet structures leading to the formation of ‘pleated sheet’ crystals oriented parallel to the fibre axis. As in synthetic polymers, the crystals are ultimately responsible for the fibre strength, presumably by functioning in silk as they do in synthetic fibres, that is, as ‘anchors’ for the noncrystalline portions of the chain.

Understanding this structure/function relationship is important to successful fibre protein engineering for the production of designed novel protein-based biomaterials. Because this relationship is critically influenced by the process of material formation in the organ that produces the product (spider spinning gland ducts, muscle foot in marine muscles, etc.) to a degree that exceeds the influence of man-made fibre processes on synthetic fibre properties, it is important to model the fibre formation process in spider glands to provide guidance for design of a material production system.

21.4 Conclusions and future trends

Clearly, then, the natural world has much to teach us. As we learn more of nature’s lessons, our ability to integrate with nature will increase. Instead of striving to establish our dominion over nature, we will become true stewards of the gifts of the natural world. This chapter has defined several of the applications to textiles from nature. In closing, I hope to stimulate further imaginative efforts in this arena.

Nature offers potential future applications in some unexpected ways, in fields as diverse as nature herself. A case in point is a recent analysis of transportation networks vis-à-vis natural systems ([American Physical Society, 2010](#); [Tero et al., 2010](#)). These publications point to the power of interpreting natural phenomena in terms of ubiquitous human issues. Robust transport network performance involves cost, efficiency and fault tolerance. Many biological networks, including slime moulds and leaf vein networks, perfected because of evolutionary selection pressure, yield reasonable solutions to what are essentially combinatorial optimization problems. The authors show how the slime mould *Physarum polycephalum* forms networks comparable with those of a real-world network, the Tokyo rail system.

Biomimetics currently has as its primary focus the structural, based on the adage that form follows function. A recent publication ([Fan et al., 2007](#)) proposes that there are possibilities for new textile materials based on yet-to-be-developed discoveries from nature. In particular, the vein structure of leaves was utilized in this work as a

model for construction of a three-dimensional fabric that has rapid initial water absorption as well as fast water transmission rate.

Notwithstanding the importance of the examples discussed in this chapter, there are other examples that the future will hold in developing truly functional materials, in the mathematical sense of a function returning a result in response to an input. We most often refer to materials that respond to stimuli as ‘smart’ or ‘intelligent’ materials. The present generation of intelligent textiles generally is engineered to contain elements that respond to specific inputs; perhaps, the most prosaic of these is the incorporation of wires and flexible ‘keyboards’ into the structure of the fabric. There is also much work being done on functionalizing the surface of fibres, such as with polymer brushes, to make the individual fibres, and hence the fibrous structure, responsive to environmental stimuli. Biomimetic materials and structures may be developed with the additional potential for structures that not only sense changes in their environment but also use these data to adapt to their environment.

The current most important future direction of biomimesis related to textiles, however, involves engineering at the molecular level. Molecular biology has been identified as one of the two (nanotechnology being the other) groundbreaking research thrusts in materials science. The report by the US National Research Council cited earlier ([National Research Council, 2008](#)) is clear in this regard. The entire breadth of this research field is well beyond the scope of the current monograph; nonetheless, there are some potential future applications of genetic engineering to textiles that may be mentioned.

Energy is at present one of the most urgent concerns we face. Solar energy clearly provides, in principle, an unlimited source of power; unfortunately, our ability to garner this energy flux in useful forms is in a primitive state, as compared with natural systems. The natural process of photosynthesis has evolved to provide the energy needed for living systems to thrive. The essential elements of this process have been understood for some time; it is only recently, however, that the molecular basis of photosynthesis has been examined. With improved understanding, we will be able to engineer synthetic fibres, and hence fibrous structures, that will provide for large-scale collection, conversion and distribution of solar energy by an analogue to photosynthesis. Molecular engineering may even be able to provide for wearable photosynthetic clothing.

Clothing that shifts shape and function in response to the environment is not a new concept. In fact, native wool provides warmth consequent to moisture absorption. Expanding the palette of possibilities for functional responsive shelter (clothing, certainly, but also structures in the built environment (see <http://www.IMSA-research.org>) will be possible with advances in molecular biology. Consider that reversible alteration of fibre stiffness by incorporation of actin-mimetic fibrils could modify the hand of a fabric, so as to make it more responsive to the environment of the wearer. The list may go on to include self-cleaning and actively protective clothing, temperature mediation by selective moisture uptake and wicking and more. But the real advances are to be made with further understanding of the molecular basis of function in the natural world. Therein lies the real challenge and the real promise.

Acknowledgements

The author would like to acknowledge the indispensable and able assistance of Ms Pam Gabriel in editing this chapter.

References

- American Physical Society, March 2010. Transportation networks as slime mold colonies. *Phys. Today* 21.
- Bahnert, T., Schlosser, U., Gutmann, R., Schollmeyer, E., 2008. Textile solar light collectors based on models for polar bear hair. *Sol. Energy Mater. Sol. Cells* 92, 1661–1667.
- Benyus, J.M., 2002. *Biomimicry: Innovation Inspired by Nature*. HarperCollins, New York.
- Bhushan, B., 2009. Biomimetics: lessons from nature – an overview. *Phil. Trans. R. Soc. A* 367, 1445–1486.
- Biqiong Chen, K.S., 2005. Mechanical and viscoelastic properties of chitin fiber reinforced poly(ϵ -caprolactone). *Eur. Polym. J.* 41 (3), 453–467.
- Cutkosky, M., Kim, S., 2009. Design and fabrication of multi-material structures for bio-inspired robots. *Phil. Trans. R. Soc. A* 367 (1894), 1799–1813.
- Dendl, P., Interwies, J., 2001. Method for Imparting a Self-Cleaning Feature to a Surface, and an Object provided with a Surface of This Type. Patent No. WO 2001/079 141. Germany.
- Doan, A., 2007. Green Building in Zimbabwe Modelled after Termite Mounds. Available at: <http://www.inhabitat.com/2007/12/10/building-modelled-on-termites-eastgate-centre-in-zimbabwe/>.
- Fan, J., Sarkar, M., Szeto, Y., Tao, X., 2007. Plant structured textile fabrics. *Mater. Lett.* 61, 561–565.
- Fedic, R., Zurovec, M., Sehnal, F., 2003. Correlation between fibroin amino acid sequence and physical silk properties. *J. Biol. Chem.* 278, 35255–35264.
- Foelix, R., 1996. *Biology of Spiders*. Oxford University Press, Oxford.
- Gao, L., McCarthy, T.J., 2006. Artificial lotus leaf prepared using a 1945 patent and a commercial textile. *Langmuir* 22, 5998–6000.
- Hayashi, C., Shipley, N., Lewis, R., 1999. Hypotheses that correlate the sequence, structure, and mechanical properties of spider silk proteins. *Int. J. Biol. Macromol.* 24, 271–275.
- Hes, L., 2009. Analysing the thermal properties of animal furs for the production of artificial furs. In: Abbott, A.G., Ellison, M.S. (Eds.), *Biologically Inspired Textiles*. Woodhead Publishing, Cambridge, pp. 150–167.
- Hirt, D., 2004. Surface Modification of CSM Fibers Using Branched Additives. NTC Project M04-CL11.
- Jeronimidis, G., Atkins, A., 1995. Mechanics of biological materials and structures: nature's lessons for the engineer. *Proc. Inst. Mech. Eng. Part C Mech. Eng.* 209 (4), 221–235.
- Koon, D.W., 1998. Is polar bear hair fiber optic? *Appl. Opt.* 37 (15), 3196–3200.
- Kornev, K., 2009. Deployable Wet-Responsive Fibrous Materials. NTC Project M08-CL10 Report.
- Lim, S., Hudson, S.M., 2004a. Application of a fiber-reactive chitosan derivative to cotton fabric as an antimicrobial textile finish. *Carbohydr. Polym.* 56, 227–234.
- Lim, S., Hudson, S.M., 2004b. Synthesis and antimicrobial activity of a water soluble chitosan derivative with a fiber reactive group. *Carbohydr. Res.* 339, 313–319.
- Luzinov, I., 2006. Ultrahydrophobic Fibers: Lotus Approach. NTC Project C04-CL06 Report.

- Lydon, J.E., 2004. Silk: the original liquid crystalline polymer. *Liq. Cryst. Today* 13 (3), 1–13.
- Mehta, R., April 30, 2006. Natural ventilation buildings. *Mater. World Mag.* Available from: <http://www.iom3.org/news/natural-ventilation-buildings-based-termite-mounds>.
- Munch, E., Launey, M.E., Alsem, D.H., Saiz, E., Tomsia, A.P., Ritchie, R.O., 2008. Tough, bio-inspired hybrid materials. *Science* 332, 1516–1520.
- National Research Council (US), 2008. *Inspired by Biology: From Molecules to Materials to Machines*. National Academies Press, Washington, DC.
- Ramaratnam, K., Iyer, K.S., Kinnan, M.K., Chumanov, G., Brown, P.J., Luzinov, I., 2008. Ultrahydrophobic textiles using nanoparticles: Lotus approach. *J. Eng. Fibers Fabr.* 3, 1–14.
- Tero, A., Takagi, S., Saigusa, T., Ito, K., Bebber, D.P., Fricker, M.D., Yumiki, K., Kobayashi, R., Nakagaki, T., 2010. Rules for biologically inspired adaptive network design. *Science* 327 (5964), 439–442.
- Tomsia, A.P., 2009. Highlights. Retrieved 2009 from Lawrence Berkley Labs: <http://www.lbl.gov/msd/assets/docs/highlights/06-09TomsiaNature.pdf>.
- Vollrath, F., Knight, D., 2001. Liquid crystalline spinning of spider silk. *Nature* 410, 541–548.
- Yao, H., Dao, M., Imholt, T., Huang, J., Wheeler, K., Bonilla, A., Suresh, S., Ortiz, C., 2010. Protection mechanisms of the iron-plated armor of a deep-sea hydrothermal vent gastropod. In: *Proceedings of the National Academy of Science*. Available from: www.pnas.org/cgi/doi/10.1073/pnas.0912988107.
- Zhao, H.-P., Feng, X.-Q., Yu, S.-W., Cui, W.-Z., Zou, F.-Z., 2005. Mechanical properties of silkworm cocoons. *Polymer* 46, 9192–9201.

Index

Note: 'Page numbers followed by "f" indicate figures and "t" indicate tables'.

A

- A/O fabrics. *See* Asphalt overlay fabrics (A/O fabrics)
- AA. *See* Amino acid (AA)
- AATCC 30, 660
- AATCC 100, 660
- Abrasion resistance, 32, 98–99
improvement, 272
- ABS. *See* Acrylonitrile butadiene styrene (ABS)
- Absorption of gas and ions, 550
- ACBs. *See* Asphalt concrete beams (ACBs)
- Acetobacter*, 672
- Acetylation, 53–54, 306
- Achyranthes aspera*. *See* Prickly chaff flower (*Achyranthes aspera*)
- Acid dyes, 50, 81–82, 266–267
application on jute, 81–83
- Acid Red 1, 454–455
- Acid Red 42, 454–455
- Acid steeping, 74
- Acidification of soils, 397
- Acoustic emission (AE), 215
- Acquired colour. *See* Extrinsic colour
- Acrylamide formaldehyde resin, 99
- Acrylated epoxidized soybean oil (AESO), 475
- Acrylonitrile butadiene styrene (ABS), 474–475
- Actinobacteria, 410
- N-Acyl phosphatidylethanolamine phospholipase D (NAPE-PLD), 430
- ADEME. *See* French National Environment Agency (ADEME)
- Adsorbable organic halides (AOX), 232, 260–261
- Advanced Fibre Information System (AFIS), 14
- Advanced Fibre-Based Materials (AFBM), 695
- Advanced thermoplastic composites (ATPC), 474
- Advanced thermoset composites (ATSC), 472
- Adzuki beans (*Vigna angularis*), 669–670
- AE. *See* Acoustic emission (AE)
- Aerosol contamination, 655–656
- AESO. *See* Acrylated epoxidized soybean oil (AESO)
- AFBM. *See* Advanced Fibre-Based Materials (AFBM)
- AFIS. *See* Advanced Fibre Information System (AFIS)
- AFM. *See* Atomic force microscopy (AFM)
- 2-AG. *See* 2-Arachidonoylglycerol (2-AG)
- Agar diffusion tests, 659–660
- Ageing WR of wool, 274–275
- Agricultural remediation, 395–396
- Agricultural residues, 610–611
- Agricultural textiles (Agro-tech), 50, 107–108, 109t
- Agriculture residues, 597–600
- Agromulching, 524
- Ahimsa Silk. *See* Eri silk
- Ahuracyl-PVN, 98–99
- Air jet
mill, 535–536
spinning, 28, 30f
- Air permeability, 43
of modified cotton and linen fabrics, 461–462, 461f
- Airborne microorganisms, 657
- ALA. *See* Alpha-linolenic acid (ALA)
- Alcalase, 233
- Alcell process, 611
- Alfalfa, 399, 399f

- Alkaloids, 425–426
 synthesis, 426
- Alkyl borates, 384–385
- Alkyl chain, 662–663
- All fibre extraction, 171–175, 174t
- Allium cepa*. See Onion (*Allium cepa*)
- Aloe barbadensis*. See Aloe vera (*Aloe barbadensis*)
- Aloe vera (*Aloe barbadensis*), 669–670
- Alpha-linolenic acid (ALA), 561, 575
- Alumina trihydrate (ATH), 386
- Aluminium, 357
- Aluminium hydroxide, 360
- Aluminium oxide (Al₂O₃), 385
- American Society for Testing and Materials (ASTM), 11–12
- Amine-terminated dendritic polymer
 cotton and linen fabrics modification
 procedure by, 454–455
 modified cotton and linen fabrics effect by,
 455–463
- Amino acid (AA), 246, 692
 composition of fibroin and sericin, 123t
- Amino-formaldehyde resins, 283
- Amino-terminated hyperbranched polymer (HBP–NH₂), 671
- Aminopropyl triethoxy silane (APTS),
 341–342
- Ammonium chloride (NH₄Cl), 356
- Ammonium molybdates, 357
- Ammonium salt of triethanolamine
 phosphoric ester acid (ATEPEA),
 370
- AMP. See Antimicrobial peptide (AMP)
- α -Amylase, 235
- Amylases, 227, 231–232, 235
- Analysis of variances (ANOVA), 458
 for air permeability of cotton and linen
 fabrics, 462t
 for bending length of cotton fabric, 460t
 for wrinkle recovery angel of cotton
 fabrics, 459t
- Anaphe Boisduval*, 129
- Anaphe carteri walsingham*, 129
- Anaphe infracta walsingham*, 129
- Anaphe moloneyi druce*, 129
- Anaphe reticulate walker*, 129
- Anaphe silk, 129
- Anaphe venta* Butler, 129
- Angiosperms, 591–593
- Animal fibres, 591
- Animal nutrition, hemp-based products for,
 571–572
- Annealing WR of wool, 274–275
- Annual plant fibres, 597–600
- ANOVA. See Analysis of variances (ANOVA)
- Antheraea assama* (muga), 121
- Antheraea mylitta* (tasar), 121, 127
- Antheraea proylei* J, 127
- Anthropogenic emission of
 pollutants, 397
- Anti-oxidative effects, 433
- Antibacterial test, 455
- Antibiotics, 671
- Antifriction agent, 66
- Antimicrobial
 agent, 659
 fabrics, 654
 finishing
 process, 659
 risks, 672–673
 textiles, 656
- Antimicrobial natural fibres, 658–660
 antimicrobial agents - chitosan,
 664–665
 cellulose fibres, 665
 mechanism, 664–665
 protein fibres, 665
 antimicrobial agents - dyes, 666
 natural dyes, 666
 synthetic dyes, 666
 antimicrobial agents - natural agents,
 669–670
 inherently antimicrobial fibres, 669
 natural bioactive agents on natural fibres,
 669–670
 antimicrobial agents - others, 670–672
 amino-terminated hyperbranched
 polymer, 671
 antibiotics, 671
 Ar–CF₄ postdischarge plasma
 treatment, 672
 built in anionic groups, 672
 chlorhexidine, 671
 enzymatic grafting, 672
 PHMB, 670
 PVP-I, 671

- regenerable agents, 671
- Triclosan, 670
- trimethoprim and sulfamethoxazole, 671
- antimicrobial agents - photomicrobicidal materials, 667–669
 - coating textiles, 668–669
 - mechanism, 668
 - semiconductors role in antimicrobial activity, 667
- antimicrobial agents - quaternary ammonium compounds, 662–664
 - cellulose fibres, 662–663
 - mechanism, 662
 - protein fibres, 664
- antimicrobial agents - silver, other metals and their salts, 660–662
 - cellulose fibres, 661
 - mechanism, 660–661
 - protein fibres, 662
- antimicrobial efficacy evaluation, 659–660
- basic mechanisms of antimicrobial effect, 658
- basic methods of manufacturing, 659
- future trends, 673–674
- requirements for antimicrobial textiles, 658
- risks of antimicrobial finishing, 672–673
 - nanoparticles, 672–673
 - triclosan, 673
- survival of microbes on fabric surfaces, 654–656
 - adherence of microorganisms to fibres, 655
 - microorganisms causing nosocomial bacteraemia, 656f
 - microorganisms on surfaces, 654
- survival time, 655–656
- textiles and microbial hazards, 653–654
 - biodeterioration of natural fibres, 653
 - everyday products, 654
 - infectious diseases, 653
- textiles as protection against biohazards and as infection reservoirs, 656–658
 - infection reservoir, 657–658
 - protection against biohazards, 657
- Antimicrobial peptide (AMP), 669–670, 674
- Antimycotic fungi, 658
- AOX. *See* Adsorbable organic halides (AOX)
- APEC. *See* Asia Pacific Economic Cooperation (APEC)
- Apo-bovine lactoferrin, 551
- Apparent fibre modulus, 212
- APTS. *See* Aminopropyl triethoxy silane (APTS)
- N-Arachidoneethanolamine (N-AEA), 429–430
- 2-Arachidonoylglycerol (2-AG), 429–430
- Aragonite, 693
- Arai, 131
- Ar–CF₄ postdischarge plasma treatment, 672
- Arjun (*Terminalia arjuna*), 127
- Arthropods, 696
- Artificial grass lawns, 644–645
- Artificial leather, 377
- Asia Pacific Economic Cooperation (APEC), 621
- Asna (*Terminalia tomentosa*), 127
- Asparagine, 246–248
- Aspergillus aureus*, 228
- Aspergillus flavus*, 228
- Aspergillus niger*, 228
- Aspergillus oryzae*, 228
- Aspergillus wentii*, 228
- Asphalt concrete beams (ACBs), 637–638
- Asphalt overlay fabrics (A/O fabrics), 635–636
- Asphalted pavements, 635
- ASTM. *See* American Society for Testing and Materials (ASTM)
- ASTM-D37, 43
- ASTM D256, 486
- ASTM D568, 488
- ASTM D618, 484–485
- ASTM D635, 488
- ASTM-D737 test method, 455
- ASTM D790, 485–486
- ASTM D638, 485
- ASTM D1117–74 method, 639–640
- ASTM D2863, 488
- ASTM D3039, 484–485
- ASTM D3801, 488
- ASTM D5528–13, 486
- ASTM D5628, 486
- ASTM D6128–00, 549
- ASTM D6773–02, 549
- ASTM-D1424, 43

- ASTM-D1442, 11–12
 ASTM-D3787, 42
 ASTM-D6797, 42
 ASTM–D 5035 test, 455
 ASTM E162, 487–488
 ASTM E662, 487–488
 ASTM E–7, 44
 ASTM E1354, 487–488
 ASTM E2149, 660
 ASTM–D1388 test method, 455
 ATEPEA. *See* Ammonium salt of triethanolamine phosphoric ester acid (ATEPEA)
 ATH. *See* Alumina trihydrate (ATH)
 Atmospheric plasma, 386
 treatment, 451–452
 Atomic force microscopy (AFM), 220
 nanomechanical investigations on flax cell walls, 220
 ATPC. *See* Advanced thermoplastic composites (ATPC)
 ATSC. *See* Advanced thermoset composites (ATSC)
Attacus atlas L, 129
 Attritors, 537–538
 Automatic reeling, 135, 136f
 Automobile-textiles (Mobil-tech), 50,
 107–108, 110t
Azadirachta indica. *See* Neem (*Azadirachta indica*)
 Azoic dyes, 301–302
- B**
- Bacillus amylobacter*, 228
Bacillus cereus, 664–665
Bacillus comesii rossii, 228
Bacillus felsineus, 228
Bacillus licheniformis, 235
 Back-coating formulation, 383
 Bacteria, 228
Bacterium amylobacter, 228
 Bacteroidetes, 411
 Bale blending, 24
 Baling, 21
 Ball mills, 536–537, 537f
 Bamboo, 230
 Basic dye application on jute, 83–84
 Basic flow energy (BFE), 548
 Basofil, 371
 Basolan ASA, 272
 Bast fibres, 593, 598
 Bast fibrous plants degumming, 228–230
 Bave, 121
 BDE-47, 360–361
 Bead mills, 538
 Bending length of modified cotton and linen fabrics, 458, 459f–460f
 Bending tests
 to estimating fibre stiffness, 211–213
 fibre modulus evaluation, 212–213
 hypothesis, 211–212
 on flax stems, 209–211
 generalities, 209
 Berkovich-type indenter, 219–220
 BET theory. *See* Brunauer–Emmett–Teller theory (BET theory)
 BFE. *See* Basic flow energy (BFE)
 BGL. *See* β -Glucosidase (BGL)
 Bifenthrin, 275–276
 Bifunctional epoxide cross-linking agents, 283
 Bio-based polymers, 696
 Bio-based thermoplastic matrix,
 475–476
 Bio-catalysts, 65
 “Bio-Mania”, 612
 Biocarbo technology, 233
 Biocompatibility, 517
 Biodegradability, 500–502
 Biodegradation
 of endogenous cannabinoids, 430
 of fibre particles, 549
 Bioderivation, 691
 Biodeterioration of natural fibres, 653
 Biofilms, 654
 Biofinishing, 231
 Biohazards, 656–658
 Bioinspiration, 691
 Bioinspired materials, 696
 Biomedical applications, 550–551
 Biomimesis, 691–694
 Biomimetics
 key principles and issues of biomimetic inspired textiles, 694–697
 using natural fibres, 695
 using synthetic fibres, 694–695
 synthetic natural fibres via molecular biology, 696–697

- key principles of biomimesis, 691–694
 - biologically inspired design and function in human systems, 693–694
 - design and function in natural systems, 692–693
 - lotus leaf surface, 693
 - overview, 691–692
 - materials, 696
 - nature as model for textile materials, 689–691
 - apparel and other coverings, 690
 - architectural and other built environment flexible materials, 690–691
 - textile materials and, 689–700
 - Biomimicry, 691, 693
 - Bioprep 3000 L, 230
 - Bioscouring, 232
 - Biosoftening of lignocellulosic fibre, 229
 - Biosynthesis of endogenous cannabinoids, 430
 - Bivoltines, 126
 - Bleach clean up, 232, 235
 - Bleaching, 604–605
 - of cotton, 289–290
 - eco friendly bleaching of jute, 104
 - of jute, 63–64, 75–76
 - of silk, 284
 - of wool, 277
 - Blended yarns, 154
 - flax cotton-like fibre for, 150
 - Blinding, 516
 - Blocking, 516
 - Blow room, 24
 - BMC. *See* Bulk moulding compound (BMC)
 - Boehmeria nivea*. *See* Ramie (*Boehmeria nivea*)
 - Boiling dyebaths, 271
 - Bombyx mori*. *See* Silkworm (*Bombyx mori*)
 - Bombyx silk. *See* Mulberry silk
 - Borax, 138
 - Boric acid, 370–371
 - Botrytis cinerea*, 228
 - Bowing of fabric, 44
 - Bradyrhizobium, 408
 - Braided jute sapling bag, 641–644
 - coir pith effect on absorbency of Coirsorb, 641t
 - comparative root growth in soil and in Coirsorb, 642f
 - results of soil analysis, 644t
 - sapling in sapling bag, 644f
 - sleeve fabric structure, 642f
 - Breco drain, 632–635, 634f
 - Brin, 121
 - Brunauer–Emmett–Teller theory (BET theory), 544–546
 - BTCA. *See* 1,2,3,4-Butanetetracarboxylic acid (BTCA)
 - Build and structural textiles (Build-textiles), 50, 107–108, 110t
 - Bulk density, 547
 - Bulk moulding compound (BMC), 481
 - Bulliform cells, 599–600
 - Bursting strength test of fabric, 42
 - 1,2,3,4-Butanetetracarboxylic acid (BTCA), 295, 372
- ## C
- C4H. *See* Cinnamate-4-hydroxylase (C4H)
 - CAGR. *See* Compound annual growth rate (CAGR)
 - Calendaring process, 645–646
 - three bowl calendaring, 646f
 - Calendering, 610
 - Candida albicans*, 659
 - Cannabichromene (CBC), 434–435
 - Cannabicyclol (CBL), 435
 - Cannabidiol (CBD), 158, 560, 567–568
 - Cannabidivarin (CBDV), 422–423, 434
 - Cannabielsion (CBE), 435
 - Cannabigerol (CBG), 422–423, 434
 - Cannabinodiol (CBND), 435
 - Cannabinoid receptors (CBRs), 428
 - Cannabinoids (CBD), 419, 422–423, 434, 567–568, 579. *See also* Phytocannabinoids
 - characteristics of most common, 422–423
 - endogenous, 429–430
 - biosynthesis and biodegradation, 430
 - psychogenic side effects of, 430–431
 - structures present in *C. sativa*, 567f
 - synthesis, 423
 - synthetic, 430
 - Cannabinol (CBN), 433–434
 - Cannabinoid acid (CBDA), 567
 - Cannabis
 - human and medicine, 427–440
 - ECS, 427–430

- Cannabis* (*Continued*)
 plant biology, 419–427
 alkaloids, 425–426
 biologically active compounds, 421–427
 flavonoids, 424
 lignanamides and phenolic amides, 426–427
 phytocannabinoids, 422–423
 sex dimorphism, 420–421
 stilbenoids, 425
 terpenes and terpenoids, 423–424
Cannabis sativa. *See* Hemp (*Cannabis sativa*)
 Cannabitrinol (CBT), 435
 Capacitive sensors, 44–45, 45f
 Carbon atoms 21 (C₂₁), 422
 Carboxymethyl cellulose, 98–99
 Carded yarns, short flax for, 149
 Carding, 24
 Carr compressibility index, 547
 Carr Index, 547–548
 Catalases, 235
 Cationic Berberine dye, 666
 Cationic hyperbranched PAMAM-chitosan, 453
 Cationization, 453
 Caustic soda, 60–61, 75, 363, 604
 treatment of jute with, 62
 CB₁ receptor, 428–430, 434–435
 CB₂ receptors, 429–430, 434–435
 CBA. *See* Cytochemical bioassay (CBA)
 CBC. *See* Cannabichromene (CBC)
 CBD. *See* Cannabidiol (CBD);
 Cannabinoids (CBD)
 CBDA. *See* Cannabinoid acid (CBDA)
 CBDV. *See* Cannabidivarin (CBDV)
 CBE. *See* Cannabiolsion (CBE)
 CBG. *See* Cannabigerol (CBG)
 CBL. *See* Cannabicyclol (CBL)
 CBN. *See* Cannabinol (CBN)
 CBND. *See* Cannabinodiol (CBND)
 CBRs. *See* Cannabinoid receptors (CBRs)
 CBT. *See* Cannabitrinol (CBT)
 CCRI. *See* Central Coir Research Institute (CCRI)
 CDB-Process, 98–99
 CDH. *See* Celobiotic dehydrogenases (CDH)
 CDs. *See* Cross directions (CDs)
- CECLlinen textile consumption, 155
 CEDED sequence, 604–605
 Cell form factor (CFF), 216
 Cell membrane complex (CMC), 251–252
 Cellulases, 65, 191, 227, 235, 238
 enzymes, 229–230
 Cellulose, 9–10, 53–55, 53f, 362–363, 600–602
 cellulose I, 288
 cellulose II, 288
 pulp, 336–337
 Cellulose fibres
 effects of chitosan, 665
 effects of QAC, 662–663
 effects of silver, 661
 Cellulose nanocrystals (NCC), 607
 production, 606–607
 Cellulosic fibres, 368–372, 451
Cellvibrio fulvus, 194–195
Cellvibrio gandavensis, 191
Cellvibrio vulgaris, 194–195
 Celobiotic dehydrogenases (CDH), 238
 Central Coir Research Institute (CCRI), 645
 Ceramic mixtures, 470
Ceriporiopsis subvermispota, 229–230
N-Cetyl pyridinium chloride (N-CPC), 338–339, 342–343
 CFF. *See* Cell form factor (CFF)
 Chalcone isomerise (CHI), 424
 Chalcone synthase (CHS), 424
 Charka reeling system, 133–134
 Chelators, 229
 Chemical catalysis, 228
 Chemical composition, 500–501
 Chemical dehairing of jute yarns and fabrics, 76–78
 Chemical finishing
 and allied processes for jute, 98–102
 eco friendly chemical finishing of jute, 105–106
 Chemical pulping, 604
 physical properties of kraft and bisulfite pulps, 604t
 Chemical texturization, 62
 Chemical thermo mechanical pulp (CTMP), 602
 Chemical treatments, 254
 cotton, 287–305

- corona treatment, 296–297
- cross-linking for durable press finishes, 293–296
- dyeing, 297–303
- environmental issues of cotton
 - processing, 303–305
- mercerization, 290–292
- physical and chemical structure, 288
- scouring and bleaching, 289–290
- treatment with liquid ammonia, 292
- silk, 280–287
 - bleaching, 284
 - chemical and physical structure, 280–281
 - cross-linking and grafting treatments, 283–284
 - dyeing and printing, 284–285
 - photoyellowing, 286
 - protein fibres, 286–287
 - treatment with acid and alkali, 285–286
 - weighting, 281–283
- vegetable fibres, 305–306
 - cross-linking, 306
 - mercerization, 305–306
- wool, 246–280
 - abrasion resistance improvement, 272
 - bleaching, 277
 - dyeing, 264–272
 - felting and shrinkproofing, 253–261
 - insect resistance, 275–276
 - physical and chemical structure, 246–252
 - setting, 261–264
 - treatments to reduce yellowing, 277–279
- Chenopodium album* L. *See* White hepatica (*Chenopodium album* L.)
- CHI. *See* Chalcone isomerise (CHI)
- China
 - hemp textiles production, 158
 - oak tasar production, 127
 - saw ginning in, 18
 - silk production, 126
- Chitanases, 227
- Chitin, 664, 664f, 695
- Chito oligosaccharides (COS), 664–665
- Chitosan, 193–194, 452–453, 659, 664–665
- Chlorfenapyr, 275–276
- Chlorhexidine, 671
- Chlorination, 254–255
- Choline, 426
- Chrome dyes, 266–267
- CHS. *See* Chalcone synthase (CHS)
- Cibacron-S/SW reactive dyes, 84–85
- Cinnamate-4-hydroxylase (C4H), 424
- Citric acid, 665
 - as cross-linking agent, 100
- 4CL. *See* 4-Coumarate CoA ligase (4CL)
- Cladosporium herbarum* Line, 228
- Classification of yarn faults (Uster CLASSIMAT), 32
- Climate change, 148
- Clogging, 516
- Clostridium felsineum*, 228
- Clothing, barrier effect of, 657
- Clove oil (*Syzygium aromaticum*), 669–670
- CMC. *See* Cell membrane complex (CMC)
- Coan silk, 129
- Coarse wools, 246
- Coating, 552, 610
 - textiles, 668–669
- COCOLAWN (transportable natural grass lawn), 644–645
- Coconut plant cultivation, 622–627
- Cocoon cooking, 132
- Cocoon sorting, 132
- Cocoon stifling, 132
- COD/BOD values, 106
- Cohesion of powder, 548–549
- Coirsorb, 639–641
- Cold Brand Reactive Dye, 84–86
- Colloidal chemical theories, 655
- Colloidal silver NPs, 661
- Colour reversion of bleached jute, 64
- Colouration, 245, 695
- Combined severity (CS), 606
- Combing, 25, 141
- Combustible fibres, 362
- Combustible materials, 540–541
- Commercial bleaching, 277
- Commonwealth Scientific and Industrial Research Organisation (CSIRO), 259
- Compact spinning, 26, 27f
- Components of flax and hemp seeds, 565
 - cannabinoids, 567–568, 579

- Components of flax and hemp seeds
(*Continued*)
essential fatty acids, 579
flax mucilage gums, 576–577
phenolic compounds, 576
phytosterols, 579
polyphenols, 566
terpenes, 568–569
tocopherols, 566, 576
- Composite reinforcement textiles, 176–190
non-woven reinforcement for composites, 177–180
 flexibility potential of flax-nonwoven fabrics, 179–180
 manufacturing processes, 178
 mechanical properties of flax non-woven fabrics, 178–179
woven fabrics manufacture for composites
 deformability of reinforcement textiles, 188–190
 manufacture of different families of yarns, 181–187
 textile architecturation techniques for 2D and 3D fabrics, 187–188
- Composites, 147
materials, 471–474
 engineering and advanced composites, 473t
 matrix resins systems for NFCs, 474–477
 organic polymer engineering composites, 473t
 of various reinforcement geometries, 472f
non-woven reinforcement for, 177–180
woven fabrics manufacture for composites, 181–190
- Compound annual growth rate (CAGR), 359
- Conductive particles, 614
- Cone Calorimeter, 368
- Contaminated environment, 653
- Contaminated textiles, 657
- Contamination
 of agricultural areas, 400
 with heavy metals, 397
 industrial and communication, 393
- Conventional H₂O₂ bleaching, 75
- Convulsions, 9
- Copper-based biocidal compound, 661
- Corchorus*, 49
Corchorus capsularis, 49
 average chemical composition, 53t
Corchorus olitorius, 49
 average chemical composition, 53t
- Cordonnet, 139
- Corona discharge, 245
- Corona treatment of cotton, 296–297
- Cortical cells, 250–251
- COS. *See* Chitooligosaccharides (COS)
- Cosmetics, 573–581
 flax in cosmeceutical industry, 580–581
 hemp in, 577–581
 modern applications, 575
 flax, 575
 flax products safety, 577–580
 flaxseed oil, 575–576
 other flax components relevant for skin care, 576–577
 traditional uses of flax and hemp for skin, 574–575
- Cottage basin, 134, 134f
- Cotton (*Gossypium* spp.), 3, 4f, 148, 230, 287–305, 658. *See also* Silk
 carding, 24
 classification, 21–22
 combing, 25
 corona treatment, 296–297
 countries of cotton production, 5f
 cross-linking for durable press finishes, 293–296
 cellulose acid-catalysed cross-linking by *N*-methylol derivatives, 295f
 cotton cross-linking with 1,2,3,4-BTCA, 296f
 cross-linking of cotton with DMDHEU derivatives, 294f
 formaldehyde condensation products
 chemical structure, 293f
 drawing, 25
 dyeing, 297–303
 continuous methods of cotton dyeing, 303
 direct dyes, 298–299
 natural dyes, 297–298
 reactive dyes, 299–301
 synthetic dyes, 298
 vat, sulphur and azoic dyes, 301–302
 electrokinetic properties, 337–340

- environmental issues of cotton processing, 303–305
 - fabric testing, 42–44
 - fabrics, 653, 669–671
 - future trends, 46–47
 - ginning mill processes and technology, 16–21
 - knitting, 38–40
 - lint colour, 13
 - mercerization, 290–292
 - nondestructive testing, 44–45
 - physical and chemical structure, 288
 - cellulose molecular structure, 289f
 - scouring and bleaching, 289–290
 - stickiness, 14
 - terry towel, 36–38
 - treatment with liquid ammonia, 292
 - weaving, 32–36
 - world cotton production, 3–5
 - consumption and trade, 3, 4f
 - yarn testing, 30–32
 - Cotton fibre, 451, 600. *See also* Flax fibre
 - chemical composition, 10, 10t
 - growth development, 7–10, 20f
 - submicroscopic structure of secondary wall, 9
 - quality properties, 10–14
 - cotton stickiness, 14
 - fibre colour, 12–13
 - fibre fineness and maturity, 11–12
 - fibre length role, 10–11
 - fibre strength and elongation, 11
 - fibre testing, 14
 - fibre weathering, 13–14
 - length uniformity and short fibre content, 11
 - moisture absorption, 13
 - Cotton grading, 22–23
 - grade standards, 22–23
 - grading of American Pima cotton, 23
 - Cotton picking
 - handpicking, 8f, 15
 - mechanical picking
 - defoliation, 15
 - msechanical cotton pickers, 16
 - mechanical cotton strippers, 16
 - Cotton seed, 15f, 43
 - Cotton yarn spinning, 23–30
 - fibre-to-yarn conversion, 28–30
 - preparation, 24–25
 - spinning systems, 25–28
 - Cottonization
 - of hemp fibres, 153–154
 - processing, 216
 - 4-Coumarate CoA ligase (4CL), 424
 - Country charka, 133–134, 133f
 - CPS. *See* Cyber-physical systems (CPS)
 - CPSC. *See* US Consumer Product Safety Council (CPSC)
 - Crabbing, 262
 - CRAILAR process, 156
 - Crease resistant property, 99–100
 - Creasing resistance, 151–152
 - Crepe, 139
 - Cross directions (CDs), 178–179
 - Cross-linking
 - for durable press finishes, 293–296
 - treatments of silk, 283–284
 - of vegetable fibres, 306
 - Cross-section area (CSA), 213
 - direct assessment, 213
 - Crotalaria juncea*. *See* Sunn hemp (*Crotalaria juncea*)
 - Cryogenic grinding, 532–533
 - Crysomallon squamiferum*, 693
 - Crystallinity, 9
 - CS. *See* Combined severity (CS)
 - CSA. *See* Cross-section area (CSA)
 - CSIRO. *See* Commonwealth Scientific and Industrial Research Organisation (CSIRO)
 - CTMP. *See* Chemical thermo mechanical pulp (CTMP)
 - Cultivated silk, 124. *See also* Mulberry silk
 - Cultivation of industrial hemp, 398
 - Cuprammonium rayon production, 695
 - Curcumin, 666
 - Cuticle cells, 250, 252
 - Cutter mill, 535
 - Cyanoethylation, 306
 - Cyber-physical systems (CPS), 46
 - Cytochemical bioassay (CBA), 568–569
- D**
- DAHP. *See* Di-ammonium hydrogen phosphate (DAHP)
 - Damaged wood, 613
 - DAP. *See* Diammonium phosphate (DAP)
 - Dasali Pattu'. *See* Tasar silk
 - DCB. *See* Double cantilever beam (DCB)

- DCCA. *See* Dichloroisocyanuric acid (DCCA)
- De-fatted jute, 57
- De-scaling methods, 254
- DEAEP. *See* Diethyl 2-(acryloyloxyethyl) phosphate (DEAEP)
- DEAEPN. *See* Diethyl 2-(acryloyloxyethyl) phosphoramidate (DEAEPN)
- DEAETPN. *See* Diethyl (acryloyloxy) ethylthiophosphoramidate (DEAETPN)
- Decarboxylation, 423
- Decatizing, 262
- Decohesion mechanisms, 215
- Defoliation, 15
- Deformability of reinforcement textiles, 188–190
- Degradative treatments. *See* Chemical treatments
- Degree of polymerization (DP), 54–55
- Degummed waste, 141
- Degumming, 131
of waste silk, 140
- Delta-9-tetrahydrocannabivarin.
See Tetrahydrocannabivarin (THCV)
- Dendrimers, 454
pretreated cotton, 454
- Denim processing, 231
- Deoxyribonucleic acid (DNA), 152,
655–656, 692
- Depithing, 611–612
- Derjaguin–Landau–Verwey–Overbeek theory (DLVO theory), 655
- Desizing, 231–232. *See also* Sizing of cotton, 289–290
eco-friendly desizing of jute, 103
of jute, 74
- DFE. *See* Directional frictional effect (DFE)
- Di-ammonium hydrogen phosphate (DAHP), 385
- Diammonium phosphate (DAP), 63, 97, 356
- Dibasic acid anhydrides, 284
- Dichloroisocyanuric acid (DCCA), 255
- Diethyl (acryloyloxy)
ethylthiophosphoramidate (DEAETPN), 386
- Diethyl 2-(acryloyloxyethyl) phosphate (DEAEP), 373
- Diethyl 2-(acryloyloxyethyl) phosphoramidate (DEAEPN), 373
- Differential scanning calorimetry (DSC), 553
- Digital inkjet printing, 285
- Dimensional changes after home laundering, 43–44
- Dimethyl methyl phosphonate (DMMP), 385
- Dimethylol dihydroxy ethylene urea (DMDHEU), 50–52, 99, 106,
293–295, 369–370
- N,N'*-Dimethylol urea (DMU), 293
- Dioxyethelene (–OCH₂O–), 55
- Direct beaming, 33
- Direct dye
application on jute, 79–81
of cotton, 298–299
- Direct warp, 33
- Directional frictional effect (DFE), 253
- Dirt, 246
- Dispersants, 540
- Diversity, 655–656
- DLVO theory. *See* Derjaguin–Landau–Verwey–Overbeek theory (DLVO theory)
- DMDHEU. *See* Dimethylol dihydroxy ethylene urea (DMDHEU)
- DMMP. *See* Dimethyl methyl phosphonate (DMMP)
- DMU. *See* *N,N'*-Dimethylol urea (DMU)
- DNA. *See* Deoxyribonucleic acid (DNA)
- Double cantilever beam (DCB), 486
- Doubling, 138, 142
- DP. *See* Degree of polymerization (DP)
- Drafting principle, 141
- Drainage/filtration, 507–508
filtration function of geotextile, 509f
photograph of three experiment, 509f
- Drawing, 25, 34, 141
- Dressing, 141
- Dry flocked method, 493–494
- Drying and conditioning, 18
- DSC. *See* Differential scanning calorimetry (DSC)
- Dust pollutants, 393–394
- Dyeing, 454–455
of cotton, 297–303
cotton fabric with anionic dyes, 453

- eco friendly dyeing of jute, 104–105
- of jute yarns and fabrics, 78–97
 - acid dyes application on jute, 81–83
 - basic dyes application on jute, 83–84
 - developments, 95–97
 - direct dyes application on jute, 79–81
 - natural dyes/colours application on jute, 92–95
 - reactive dyes application on jute, 84–86
 - sulphur dyes application on jute, 90–92
 - vat dyes application on jute, 86–90
- effect of modified cotton and linen fabrics, 455–456
- of silk, 284–285
- of wool, 264–272
- Dynamic properties of fibre powders
- Dyes, 666, 673
 - natural, 666
 - synthetic, 666
- E**
- Earthquake, jute as protection of, 525
- ECB. *See* Erosion control blankets (ECB)
- ECF. *See* Elementary Chloride Free (ECF)
- ECM. *See* Erosion control meshes (ECM)
- ECN. *See* Erosion control nets (ECN)
- Eco-friendly processing of jute, 102–106
 - eco-friendly
 - bleaching of jute, 104
 - chemical finishing of jute, 105–106
 - desizing of jute, 103
 - dyeing of jute, 104–105
 - printing of jute, 105
 - scouring of jute, 104
 - softening of jute, 103
 - non-toxic (hydrocarbon free) batching oil use, 103
 - use of alternative chemicals, 106
- Eco-friendly textiles (Eco-Tech or oeko-Tech), 50
- Economic value of hemp fibres, 157–159
- ECRM. *See* Erosion control re-vegetation mats (ECRM)
- ECS. *See* Endocannabinoid system (ECS)
- Edestin, 566
- EDL. *See* Electrochemical double layers (EDL)
- EDTA. *See* Ethylene diamine tetraacetic acid (EDTA)
- EFAs. *See* Essential fatty acids (EFAs)
- Effective Microorganisms (EM), 400
- EFG. *See* Environmentally friendly goods (EFG)
- EG. *See* Environmental goods (EG)
- EGS. *See* Environmental goods and services (EGS)
- Eicosapentaenoic acid (EPA), 562
- Elasticity of linen, 150–152
- Electrochemical double layers (EDL), 325–326, 326f
- Electrokinetic properties, 323–353
 - applications, 335–346
 - effect of bleaching on hair fibres zeta potential, 345f
 - cellulose pulp, 336–337
 - cotton, 337–340
 - human hair, 343–346
 - other cellulosic fibres, 340–342
 - regenerated cellulose, 342–343
 - silane treatment on cellulose fibre zeta potential, 341f
 - time dependence of zeta potential for bleached cotton and regenerated cellulose fibres, 342f
 - waxes extraction with alcoholbenzene azeotropes effect on zeta potential of jute, 341f
 - zeta potential pH dependence for raw and differently treated cotton fibres, 337f
 - future trends, 346–347
 - key principles, 324–335
 - binding isotherm and kinetics of adsorption of cationic surfactant on natural fibre, 335f
 - dependencies of zeta potential on electrolyte pH, 331f
 - electrochemical double layer model, 326f
 - electrokinetic phenomena principles schematic representation, 325f
 - experimental methods, 329–330
 - measuring cell design for fibre samples streaming potential measurement, 329f
 - streaming current and potential generation, 326f
 - streaming potential vs. differential pressure for bleached cotton fibre, 330f

- Electrokinetic properties (*Continued*)
 theoretical background, 325–328
 time dependence of zeta potential, 334f
 zeta potential of natural fibres, 330–335
 zeta potential of polymer surfaces with
 different hydrophobicity, 332f
 zeta potential representative dependence
 on ionic strength, 333f
- Electron beam radiation, 671
- Electronical functions, 614
- Elementary Chloride Free (ECF), 604–605
- Elementary fibre cohesion evaluation within
 bundle, 215–216
 decohesion mechanisms, 215
 process on cohesion between elementary
 fibres, 215–216
- Elementary flax fibres, tensile behaviour of,
 216–217
- Elongation, yarn, 31
- ELS cotton. *See* Extra-long staple cotton
 (ELS cotton)
- EM. *See* Effective Microorganisms (EM)
- EN 61, 484–485
- EN 14119, 660
- EN ISO 180:2000, 486
- EN ISO 6940:2004 method,
 375–376, 376t
- Encapsulation of oils, 565
- Endi silk. *See* Eri silk
- Endocannabinoid system (ECS),
 427–428
 biological significance, 428
 components, 428–430
 CB₁, CB₂ receptors, 428–429
- Endogenous cannabinoids, 429–430
- Energy, 698
- Engineering Thermoplastic (ETP), 361
- Engineering thermoplastic composites
 (ETPC), 474
- Engineering thermoplastic natural fibre
 composite products (ETNFC
 products), 474
- Engineering thermoset composites
 (ETSCs), 472
- Entourage effect, 569
- Environmental goods (EG), 621
- Environmental goods and services
 (EGS), 621
- Environmental textiles from jute and coir,
 621–651
 critical properties of fibres, 628–629
 fibres extraction, 627–628
 jute and coconut plant cultivation, 622–627
 comparative overview of jute, coconut
 and coir fibre cultivation, 623t
 global production of coconuts and coir
 fibres in, 626t
 market potential, 647–648
 nature of commercial products, 629–631
 novel environmental textiles from jute and
 coir, 631–647
 overview, 621–622
- Environmentally friendly goods (EFG),
 621–622
- Enzymatic catalysis, 227–228
- Enzymatic degumming
 of natural fibres, 227
 of ramie fibre, 230
- Enzymatic grafting, 672
- Enzymatic retting, 230, 628
- Enzymatic treatment, 227–244
 finishing in textile industry, 231–234
 biopolishing, 231
 bleach clean up, 232
 desizing, 231–232
 scouring, 232
 silk degumming, 233
 wool fibre modification, 233–234
- future trends, 239
- key principles, 227–234
 bast fibrous plants degumming,
 228–230
- types, 234–239
 amylase, 235
 catalases, 235
 cellulases, 235
 flax pectin decomposition and its
 products, 236f
 laccase, 237–239
 pectinases, 236–237
 proteases, 237
- Enzyme
 activity, 227–228
 assisted bio-chemical finishes, 102
 treatment of jute, 65–66

- EPA. *See* Eicosapentaenoic acid (EPA); US Environmental Protection Agency (EPA)
- Eperia*, 130
- 2,3-Epoxypropyltrimethylammonium chloride, 304–305
- Eri silk, 128, 143–144
worm and cocoons, 128f
- Ericulture, 128
- Erosion control, 507, 509, 523
natural geotextile of coir fibres, 524f
- Erosion control blankets (ECB), 514
- Erosion control meshes (ECM), 514
- Erosion control nets (ECN), 514
- Erosion control re-vegetation mats, (ECRM), 514
- Errandi silk. *See* Eri silk
- Erwinia carotovora*, 228
- Escherichia coli*, 228, 655, 659
- Essential fatty acids (EFAs), 579
- Esterases, 238
- Ethanediol oxidases (GIOx), 238
- Ethylene diamine tetraacetic acid (EDTA), 229, 284
- ETNFC products. *See* Engineering thermoplastic natural fibre composite products (ETNFC products)
- ETP. *See* Engineering Thermoplastic (ETP)
- ETPC. *See* Engineering thermoplastic composites (ETPC)
- ETSCs. *See* Engineering thermoset composites (ETSCs)
- Evenness, yarn, 31
- Experimental tensile testing, 216
- Explosion risks of fibre powders, 540–541
- Extra-long staple cotton (ELS cotton), 18, 22
calibration cotton, 22–23
- Extracellular polymeric substances, 654
- Extractor feeder, 18
- Extrinsic colour, 13
- F**
- FAAH. *See* Fatty acid amide hydrolase (FAAH)
- Fabric testing, 42–44
air permeability, 43
bowing and skewness test of fabric, 44
bursting strength test of fabric, 42
dimensional changes after home laundering, 43–44
fabric (weight) areal density test, 43
tensile strength
and elongation test of fabric, 40
test of fabric, 43
yarn slippage test, 44
- Fabric(s)
characteristics, 657
chemical dehairing and photo-stabilization of, 76–78
dyeing of, 78–97
finishing, 162
- Fagara silk, 129
- FAO. *See* Food and Agriculture Organization (FAO)
- Fats in jute, 56
- Fatty acid amide hydrolase (FAAH), 430
- FDA. *See* Food and Drug Administration (FDA)
- FDAS. *See* Fibre Dimensional Analysis System (FDAS)
- Feeding, 18
- Fehrer's DrefRing development, 26
- Felting, 253
- Felting and shrinkproofing of wool, 253–261
- Fibre, 591, 600. *See also* Cotton fibre; Flax fibre
blends with wool, 375
colour, 12–13
explosion risks of fibre powders, 540–541
fibre-based materials, 690–691
fibre-matrix interface, 215
fibre-reinforced plastics, 470
fibre-to-yarn conversion, 28–30
fineness, 26–27
fineness and maturity, 11–12
length role, 10–11
orientation, 609–610
particles, 531–532
biodegradation of, 549
size and morphology, 541–543, 543f
surface area of, 544–546
surface energy of, 546
processing, 152
shedding, 98–99
spinning, 181–182, 182f

- Fibre (*Continued*)
 strength and elongation, 11
 testing, 14
 and labelling, 21
 weathering, 13–14
 world fibre production and use, 3–5
- Fibre Dimensional Analysis System (FDAS), 213
- Fibreglass-reinforced plastics (FRP), 472
- Fibroin, 121, 123, 280–281
 amino acid composition, 123t
 in *Bombyx mori*, 122–123
 crystal structure of the poly peptide, 123f
- FIGRA. *See* Fire Growth Rate Index (FIGRA)
- Filament, 121
- Filature, 131
- Financial value of hemp fibres, 157–159
- Fine stirred media mills, 538
- Fineness, 214
- Finishing in textile industry, 142–143, 231–234
 biopolishing, 231
 bleach clean up, 232
 desizing, 231–232
 scouring, 232
 silk degumming, 233
 wool fibre modification, 233–234
- Fire Growth Rate Index (FIGRA), 368–369
- Fire retardants, 355
 property, 101
- Firmicutes, 410
- Fish wool, 129
- Fixer CCL, 50–52, 97, 105
- Flame resistant cotton batting, 370–371
- Flame retardancy, 355–391
 flammability and, 368–378
 cellulosic fibres, 368–372
 cone calorimetric data and ranking order of samples, 369t
 flammability of some fabrics treated by different flame retardants, 380t
 leather, 375–378
 protein fibres, 372–375
 range of application of FR fabrics, 378
 review of fire retardants (non-durable) for fabric protection, 379t
 review of fire retardants for durable (wet cleaning) fabric protection, 380t
 risk analysis of 26 selected flame retardants, 381t
 future trends, 384–386
 historical background, 355–358
 key issues, 362–368
 flammability properties of various fibres, 364t
 FR treated lignocellulosic fibres burning mechanism, 367f
 retardancy mechanism, 365t–366t
 untreated lignocellulosic fibres burning mechanism, 366f
- market, 359–361
 applications, 361t
 flame retardants consumption by region, 359f
 global market, 360f
 US market, 360t
- methods of improvement, 378–384
 amount of finishing add-on for cotton to acquire flame retardancy, 382t
 flame retardant textile back-coatings, 383–384
- Flame retardants (FR), 355, 357, 370
- Flammability testing, 487–488
- Flatbed scanning, 213
- Flavonoids, 424, 436–437
 effect of, 437
 synthesis, 424
- Flax (*Linum usitatissimum* L.), 205, 228
 cotton-like fibre for blended yarns, 150
 fibres, 206
 link between stem structure and fibre performance, 206–208
 mucilage, 574
 mucilage gums, 576–577
 multi-scale mechanical characterization, 208–220
 plant architecture, 206–207
 retting, 230
 seed oils, 565
 slenderness and stability, 207–208
 soap, 576
 stem, 208
 bending tests, 209–211
- Flax cell walls, nanomechanical investigations on, 219–220
- Flax fibre, 148, 169, 451, 557–558. *See also* Cotton fibre; Hemp fibres

- aligned stems, 175–176
- amino acid composition, 563t
- application in cosmetics and personal care, 573–581
- composite reinforcement textiles, 176–190
 - manufacture of woven fabrics for composites, 181–190
 - non-woven reinforcement for composites, 177–180
- economic factors affecting production, 558–560
- impact of extraction and preparation, 171–176
- fibre processing, 152
- flax cotton-like fibre for blended yarns, 150
- future trends, 161–163
- geotextiles, 190–195
 - degradation of geotextiles, 191–192
 - solutions to control biodegradation of textiles, 192–195
- global production, 558t
- green decorticated fibre, 150
- long flax fibre for hackled yarns, 149
- nutritional and health effects, 563–569
 - cannabinoids, 567–568
 - comparative nutrient profile, 564t
 - oils, 565
 - protein, 566
 - terpenes, 568–569
 - tocopherols and polyphenols, 566
- processing for textiles, 152–154
- products for food and dietary supplements
 - for human and animal nutrition, 569–572
- properties and chemical composition, 560–563
 - essential fatty present in common vegetable oils, 561f
 - major fatty acids profile, 562t
 - oil composition, 560–562
 - protein profile, 562–563
- randomly orientated flax stems, 171–175
- regulatory issues regarding novel flax and hemp products, 572–573
- short flax for carded yarns, 149
- statistics of flax production, 159
- technical properties of flax fibres, 150–152
 - for textile applications, 148–155
 - textile fibres for reasonable blends, 154–155
 - textile products end uses, 156–157
- Flax plant, model for biomimetics, 206–208
- Flaxseed oil in cosmetics and personal care, 575–576
 - flax soap, 576
 - in haircare products, 576
- Flexural strength, 208
- Flowability of powder, 548–549
- Fluorescent whitening agent (FWA), 277, 278f
- Food and Agriculture Organization (FAO), 157
- Food and Drug Administration (FDA), 439
- Formability potential of flax-nonwoven fabrics, 179–180
- Formaldehyde, 293
- Four-point loading system, 486
- Fourier transform infrared
 - microspectroscopic mapping (FTIR microspectroscopic mapping), 229
- FR. *See* Flame retardants (FR)
- Fracture toughness, 486, 493–494
- France-based Saflin, 162
- French National Environment Agency (ADEME), 171–174
- Friction
 - spinning, 28, 29f
 - yarn, 32
- Fried Test, 230
- FRP. *See* Fibreglass-reinforced plastics (FRP)
- Fruit fibres, 593, 600
- FTIR microspectroscopic mapping.
 - See* Fourier transform infrared microspectroscopic mapping (FTIR microspectroscopic mapping)
- Fuel, Fodder, Fertilizer, Fibre, Feedstock and Further uses (6 F's), 597
- Fulling, 253
- Functional food, 575
- Fusarium*, 234
- FWA. *See* Fluorescent whitening agent (FWA)

G

G protein-coupled receptors (GPCR), 428
GPCR55 and GPCR18, 432

GA. *See* Glutaraldehyde (GA)

GABA. *See* Gamma-aminobutyric acid (GABA)

β -Galactosidase, 228

Gamma radiation, 386

Gamma-aminobutyric acid (GABA), 428, 434

Gamma-linolenic acid (GLA), 561

Gassing, 142–143

Gauge length, 214–215, 214f

Gentian violet, 666

Geometry of particles

Geosynthetic materials, 499

functional requirements of, 504–507

for reinforcing geotextiles, 505t

of typical geotechnical problems, 506t

global geotextile market, 503f

synthetic geotextile, 514f

in road stabilization, 510f

Geotextile tube breakwaters, 517

Geotextiles (Geo-tech), 50, 107–108, 108t, 170, 499–502, 508, 511

in civil engineering, functions and applications of, 511–520

in filtration and drainage applications, 519f

filtration function of, 509f

functional requirements for reinforcing, 505t

in order to meet their performance, 512f

primary uses, 507–511

drainage/filtration, 508

erosion control, 509

reinforcement, 510–511

sediments control, 511

separation or stabilization, 507–508, 508f

properties of, 500–501, 511, 523–525

porosity and permeability, 515

as protection function, 513f

in rural road construction, 523

on side of pond, 516f

tube for coastal protection, 517f

Gin stand, 17–18

Ginning mill processes and technology, 16–21

GLA. *See* Gamma-linolenic acid (GLA)

Glass mat/thermoplastic (GMT), 483

Glass transition temperature (T_g), 272–273

Gliocladium, 234

D-Glucopyranose units, 9

Glucose oxidases, 238

β -Glucosidase (BGL), 551

Glutamine, 246–248

Glutaraldehyde (GA), 385

Glyco-lignin, 55

Glycols, jute treatment with, 65

GMT. *See* Glass mat/thermoplastic (GMT)

Gossypium spp. *See* Cotton

(*Gossypium* spp.)

GPCR. *See* G protein-coupled receptors (GPCR)

Grafting treatments of silk, 283–284

Granulobacter pectinovorum, 228

Grass fibres, 593

Green composites

for automotive applications, 490–492, 491f

auto parts made from various NFCs, 491f

for building materials, 488–490

decking produced from wood/plastic

composites, 489f

pultruded NFC products, 490f

Green decorticated fibre, 150

Grenadine, 139

Grey fabric inspection, 36

Griffith's theory, 216

Gymnosperms, 591–593

H

Hackled long flax, 149

Hackled yarns, long flax fibre for, 149

Hackling, 175–176

Haircare products, flaxseed oil in, 576

Hairiness, yarn, 32

N-halamine, 671

Half-milling dyes, 266–267

Halogen-free flame retardants, 370

HaloSYS project, 413

Handpicking, 8f, 15

Hard keratins, 248

Hardwood fibres, 591–593, 596–597

HDPE. *See* High-density polyethylene (HDPE)

HDPP. *See* N-Hydroxymethyl (3-dimethyl phosphono) propionamide (HDPP)

Heat release rate (HRR), 362

- Heat retention, 150–152
- Heat sensitivity of organic materials, 533
- Hemi-lignin, 55
- Hemicellulose, 52–53
- Hemicelluloses, 55, 600–602
- Hemp (*Cannabis sativa*), 399, 419–421, 420f, 423–426, 437, 557–560, 575, 579–581
- alkaloids occurring in, 426f
 - application in cosmetics and personal care, 573–581
 - modern applications, 575
 - other hemp compounds acting on skin, 579–580
 - traditional uses of flax and hemp for skin, 574–575
- bast fibres, 599
- economic factors affecting production, 558–560
- flavonoids occurring in, 424f
- future trends, 413
- global production, 558t, 559f
- hemp-based products
- for animal nutrition, 571–572
 - for human nutrition, 569–571
- hemp-containing products, 570t
- key issues in recultivation of polluted lands, 394–397
- areas before starting remediation process, 396f
 - devastated and degraded land, 396t
 - main producers of brown coal in world, 395t
- methods of recultivation and remediation of polluted lands, 398–402
- alfalfa grown in reclaimed areas, 399f
 - hemp grown in reclaimed areas, 398f
 - potential soil pollution by various industries, 401t–402t
- monoterpenes occurring in, 423f
- nutritional and health effects of, 563–569
- comparative nutrient profile, 564t
- phytocannabinoids occurring in, 422f
- regulatory issues regarding novel flax and hemp products, 572–573
- in remediation of degraded lands, 393–417
- results of reclamation work, 403–412
- stilbenoids occurring in, 425f
- United States and, 560
- Hemp Farming Act (2018), 573
- Hemp fibres, 153. *See also* Flax fibres
- cottonization of, 153–154
 - financial and economic value, 157–159
 - knitting, 154
 - textile products end uses, 156–157
 - viscose fibre, 154
- Hempseed
- amino acid composition, 563t
 - oils, 565
 - in cosmetics, 577–578
 - in soaps and shampoos, 578–579
 - properties and chemical composition of, 560–563
 - cannabinoids, 567–568
 - oil and protein content in common oil seed, 561t
 - oil composition, 560–562
 - protein profile of, 562–563
 - terpenes, 568–569
 - tocopherols and polyphenols, 566
- Hercosett 125, 258–260, 259f
- Hessian, 69
- Hexamethylene disiloxane (HMDSO), 386
- HFPO. *See* Hydroxylfunctional organophosphorus oligomer (HFPO)
- Hibiscus sativa*. *See* Kenaf (*Hibiscus sativa*)
- High Exhaustion Reactive Dye, 84–85
- High-density polyethylene (HDPE), 49–50, 451–452, 476
- High-Volume Instrument (HVI), 14, 21
- HMDSO. *See* Hexamethylene disiloxane (HMDSO)
- Holo-cellulose, 52–53
- Home textiles (Home-tech), 50, 107–108, 109t
- Host–guest
- properties
 - of dendrimer and guest molecules, 455–456
 - in modified fabrics, 463
 - reactions of amine-terminated dendritic group, 455–456
- Hot air drying, 132
- Hot Brand Reactive Dye, 84–85
- HRR. *See* Heat release rate (HRR)
- Human hair, 343–346
- Human nutrition, hemp-based products for, 569–571

HVI. *See* High-Volume Instrument (HVI)
 Hydrogen peroxide (H₂O₂), 232
 Hydrolases, 235
 Hydrolysis of proteins fibres, 534
 Hydrolyzed reactive dye, 85
 Hydrophobic bond, 248
 Hydrophobic matrix resin systems, 470
 Hydroxylfunctional organophosphorus oligomer (HFPO), 369–370
N-Hydroxymethyl (3-dimethyl phosphono) propionamide (HDPP), 373
 Hygienic applications of silver NP, 660
 Hydroscopicity of linen, polyester and blended fabrics, 150, 151f

I

IJIRA. *See* Indian Jute Industries Research Association (IJIRA)
 ILSS. *See* Interlaminar shear strength (ILSS)
 Immobilisation of enzymes
 Imperfections, 32
 yarn, 31
 Indian Jute Industries Research Association (IJIRA), 103
 Indigo, 301, 301f
 INDURA fabrics, 370
 Industrial and communication contamination, 393
 Infection reservoir, 657–658
 Infectious diseases, 653
 Infrared thermogram (IR thermogram), 487
 Inherently antimicrobial fibres, 669
 Inherently antimicrobial natural polymers, 659
 Insect
 nerve toxins, 275–276
 resistance of wool, 275–276
 silks, 692
 Insect-resist agents (IR agents), 275
 Institute of Natural Fibres (INF), 398
 Institute of Natural Fibres and Medicinal Plants (INF&MP), 148, 161f, 412–413
 Instrument Standards Instrument standards, 22–23
 Inter fibre interfaces, 213–216
 Interfacial conductance, 332
 Interlaminar shear strength (ILSS), 493
 Intermediate filaments, 250–251

International System of Units (SI Units)
 Denier, 31
 Ne (number of hanks in English count), 31
 Nf (number of hanks in French count), 31
 Nm (number of hanks in metric count), 31
 tex, 31, 214
 International Wool Secretariat (IWS), 259
 Intrinsic colour, 13
 Intumescent FRs, 382
 Invasive plants, 613
 IR agents. *See* Insect-resist agents (IR agents)
 IR thermogram. *See* Infrared thermogram (IR thermogram)
 Iron sulphide particles, 693
 ISO 178, 485–486
 ISO 3268, 484–485
 ISO 3795:1989(E) method, 375, 376t
 ISO 4046 standard, 591
 ISO 20645, 660
 ISO 20743, 660
 Isopeptide bonds, 248
 Italy-based Marioboselli Jersey, 162
 Ito2, 131
 IWNiRZ. *See* Institute of Natural Fibres and Medicinal Plants (INF&MP)
 IWS. *See* International Wool Secretariat (IWS)

J

JAO. *See* Jute-asphalt overlay fabric (JAO)
 JBO. *See* Jute batching oil (JBO)
 Jet lint cleaner, 19–20
 Jute, 49, 229–230, 306
 bleaching/oxidation of jute, 63–64
 Carding, 50–52
 cellulose, 52–54
 chemical processing, 74–102
 chemical dehairing and photo-stabilization of jute yarns and fabrics, 76–78
 chemical finishing and allied processes for jute, 98–102
 desizing, 74
 dyeing of jute yarns and fabrics, 78–97
 pigment printing of jute, 97
 scouring and bleaching, 75–76
 cultivation, 622–627
 Darwin, 50–52

- diversified end uses as technical textiles, 106–111, 107f
- eco-friendly processing of, 102–106
- enzyme treatment, 65–66
- fabrics, 73
- fats and waxes in, 56
- future trends, 111–112
- hemicellulose, 54–55, 54f
- inter-unit linkages in, 57
- mechanical processing, 67–69
- pectins in, 57
- photo-yellowing or colour reversion of bleached jute, 64
- physical structure and properties, 58–60
- reed, 58
- Spinning, 50–52
- stabilized bleaching of jute, 64–65
- treatment
 - with caustic soda, 62
 - with glycols, 65
 - with metal salt and complexes, 63
 - with silicone, 66
- uses, 51t–52t
- warp, 50–52
- Jute and coir
 - commercial products from, 630t
 - critical properties, 628–629
 - environmental textiles from, 621–651
 - overview, 621–622
 - fibre extraction, 627–628
 - coconut grove with backwater and retted husks, 628f
 - jute and coconut plant cultivation, 622–627
 - comparative overview of jute, coconut and coir fibre cultivation, 623t
 - global production of coconuts and coir fibres in, 626t
 - market potential of jute-coir environmental textiles, 647–648
 - nature of commercial products from, 629–631
 - novel environmental textiles from jute and coir, 631–647
 - Braided jute sapling bag, 641–644
 - JAO, 635–639
 - jute-coir PVD, 632–635
 - pre-seeded erosion control blanket, 631–632
 - super absorbent coir mat, 639–641
 - transportable natural grass lawn, 644–645
 - waterproof jute packaging, 645–647
 - physical properties of, 629t
- Jute batching oil (JBO), 66, 103
- Jute fibre, 49–52, 599
 - chemical aspects and effect of chemical treatments, 60–66
 - chemical composition and structure, 52–60
 - multicellular structure, 58f
 - physical properties, 59t
 - recipe and treatment condition for oxidative bleaching, 77t
 - treatment with jute batching oil, 66
- Jute weaving, 69–74
 - developments, 72–74
 - idea about motions of weaving machine, 72
 - jute cloth and bag specifications, 70t
 - jute yarn conversion to fabric, 71–72
 - techniques, 69–71
- Jute Weaving Machines. *See* Looms
- Jute yarns, 75
 - chemical dehairing and photo-stabilization of, 76–78
 - dyeing of, 78–97
 - spinning of, 67–69
- Jute-asphalt overlay fabric (JAO), 635–639
 - crack propagation in unreinforced ACB, 639f
 - Leno structure of JAO grid, 637f
 - painted ACB reinforced with JAO, 638f
- Jute-coir PVD, 632–635
 - Pressure and kink dependent discharge capacity profile
 - view of Brecodrain, 634f
- Jute-lignin, 55, 56f
- K**
- K/S values
 - of modified and unmodified cotton fabrics, 456, 456f
 - of modified and unmodified linen fabrics, 456, 457f
- Kenaf (*Hibiscus sativa*), 236, 306
 - fibre enzymatic degumming, 230
- Keratinization, 248
- Keratinous proteins of wool, 248
- α -Keratins, 246

- Kerosene, 105
 oil, 97
 Kevlar, 375
 Kier, 289
Klebsiella pneumoniae, 659
 Knit stitch, 40, 41f
 Knitting, 38–39, 154
 of cotton, 38–40
 of hemp fibres, 38–40
 principle
 loop and stitch, 39
 stitch, 40
 tuck, 40
 WARP, 39
 weft, 39
 Knotting, 34
 KPS. *See* Potassium persulfate (KPS)
 Kraft, 604
- L**
- Laccase, 237–239
 Lanaguard process, 275–276
 Lanthionine, 262
 Laroche (France) Cadette 1000 fibre
 extraction device, 172, 173f
 Lauryl gallate, 672
 Layer-by-layer method, 386
 LCA. *See* Lifecycle analysis (LCA)
 LCM family. *See* Liquid composite
 moulding family (LCM family)
 LDPE. *See* Low-density polyethylene
 (LDPE)
 Leaf fibre, 593
 Leasing, 34
 Leather, 375–378
 flammability, 375–378, 376t–377t
 Length uniformity, 11
 Lethal concentration (L(C)),
 672–673
 Leucine, 248
 Levelling acid dyes, 266–267
 Lifecycle analysis (LCA), 621
 Lignanamides, 426–427
 occurring in *Cannabis sativa*, 427f
 synthesis, 427
 Lignification, 55
 Lignin, 55, 238–239, 600–602
 associations, 55
 degradation, 238
 precursors, 56f
 Lignin peroxidises (LiP), 238
 Ligninases, 238
 Lignite, 393, 395
 Lignocellulosic fibres, 227
 Lignocellulosic powder explosion
 Lignocellulosic textiles, 207–208
 Lime fertilization, 400
 Limiting oxygen index (LOI), 370, 488
 Linear density
 tex, 31, 214
 yarn, 30–31
 Lineic mass, 214
 Linen, 153
 applications and examples, 155–159
 fabrics, 148, 156, 164t–165t
 sheets, 152
 swells, 150
 textile linen area of application, 155f
 world linen consumption, 155f
 Linificio company, 149
 Linseed flax, 171–175, 173f
 tensile properties, 174t
 Linseed oil, 574
Linum usitatissimum L. *See* Flax (*Linum
 usitatissimum* L.)
 LiP. *See* Lignin peroxidises (LiP)
 Liquid ammonia, 62, 363
 treatment with, 292
 Liquid composite moulding family (LCM
 family), 170, 481
 Liquid propagation, 695
 LOI. *See* Limiting oxygen index (LOI)
 Long flax fibre for hackled yarns, 149
 Long staple cotton (LS cotton), 18, 21
 Looms, 69–71
 Loop and stitch, 39
 Lotus effect, 695
 Low-density polyethylene (LDPE), 476,
 645–646
 LS cotton. *See* Long staple cotton (LS
 cotton)
 Lumen, 217, 288
 Lysinoalanine, 262
 Lysozymes, 227
- M**
- Machine direction (MD), 178–179, 479
 Macrofibrils, 250–251
 MAGL. *See* Monoacylglycerol lipase
 (MAGL)
 Major ampullate spidroin 1 (MASp1),
 696–697

- Major ampullate spidroin 2 (MAsp2), 696–697
- Maleic anhydride-modified polypropylene (MAPP), 483
- Man-made fibre (MMF), 3, 4f
- Man-made polymeric materials, 507
- Manganese peroxidases (MnP), 238
- MAPK. *See* Mitogen-activated protein kinase (MAPK)
- MAPP. *See* Maleic anhydride-modified polypropylene (MAPP)
- Marijuana plant. *See* Hemp (*Cannabis sativa*)
- Marijuana State Laws, 573
- Market potential of jute-coir environmental textiles, 647–648
- MAsp1. *See* Major ampullate spidroin 1 (MAsp1)
- MAsp2. *See* Major ampullate spidroin 2 (MAsp2)
- Mass loss rate (MLR), 368
- Material Testing System (MTS), 637–638
- Matrix, 250–251
- materials, 471
 - resins systems for NFCs, 474–477
 - thermoplastics derived from renewable sources, 477f
 - unfilled thermosetting resin properties, 475t
- Mayoquestn, 229
- McCarthy roller gin principle, 17f, 19
- MD. *See* Machine direction (MD)
- MDPA. *See* *N*-Methylol dimethylphosphonopropionamide (MDPA)
- Mechanical picking
- defoliation, 15
 - mechanical cotton pickers, 16
 - mechanical cotton strippers, 16
- Mechanical pulping, 602–603
- main characteristics, 603t
- Media milling, 534–535
- Media mills. *See also* Non-media mills
- ball mills, 536–537, 537f
 - fine stirred media mills, 538
 - shaker mills, 536
 - stirred media mills, 537–538
- Medium staple cotton (MS cotton), 21
- Medium to LS cotton (MLS cotton), 21
- Melaleuca alternifolia*. *See* Tea tree (*Melaleuca alternifolia*)
- Melamine, 367
- Melamine formaldehyde, 50–52
- Mercerization
- of cotton, 290–292
 - of vegetable fibres, 305–306
- Mercer's process, 290
- 1:1 or 1:2 metal complex dyes, 81
- Metal salt, jute treatment with, 63
- Metastannic acid (H_2SnO_3), 282–283
- Methicillin-resistant *Staphylococcus aureus* (MRSA), 567–568, 666
- N*-Methylol acrylamide, 99
- N*-Methylol
- dimethylphosphonopropionamide (MDPA), 369–370
- Methylol-based cross-linking resin, 99
- MFC. *See* Microfibrils of cellulose (MFC)
- MFRs. *See* Microencapsulated fire retardants (MFRs)
- Micro-braiding, 183
- Micro crystals of cellulose, 607
- Microbes survival on fabric surfaces, 654–656
- Microbial hazards, 653–654
- Microcapsules for finishing, 385
- Microencapsulated fire retardants (MFRs), 371
- Microencapsulation, 347, 385
- Microfibrils, 250–251
- Microfibrils of cellulose (MFC), 606, 613–614
- production, 606–607
- Microorganisms on surfaces, 654
- Middle lamella (ML), 600–602
- Mild alkali, 60
- Mildews, 228
- Military fabrics, 653
- Milling, 253
- dyes, 266–267
 - fibres, 531
 - natural fibre, 534–535
 - challenges of, 532–533
 - explosion risks of fibre powders, 540–541
 - media mills, 536–538
 - methods of, 534–541
 - non-media mills, 535–536

- Milling (*Continued*)
 obtaining powder after wet milling, 539–540
 process parameters in milling, 540
 wet milling advantage, 538–539, 539f
 natural fibre powder production by, 532–541
- Mineral fillers, 385
- Mineral turpentine oil (MTO), 97
- Miranda aurentia*, 130
- Mitin FF, 273–274
- Mitogen-activated protein kinase (MAPK), 428
- Miuraori origami-like structures, 694
- ML. *See* Middle lamella (ML)
- MLR. *See* Mass loss rate (MLR)
- MLS cotton. *See* Medium to LS cotton (MLS cotton)
- MMF. *See* Man-made fibre (MMF)
- MnP. *See* Manganese peroxidases (MnP)
- Modacrylic, 371
- Modal blended yarns, 155
- Modified basic dyes, 83
- Modified cotton and linen fabrics
 antibacterial results, 464t
 effect by amine-terminated dendritic polymers
 air permeability, 461–462, 461f
 antibacterial properties, 463
 bending length, 458, 459f–460f
 dyeing effect, 455–456
 moisture regain, 462–463, 462t
 tensile strength, 458–460, 461t
 WRA, 457–458
 future trends, 463
 modification procedure by amine-terminated dendritic polymer, 454–455
 antibacterial test, 455
 characterization, 454–455
 dyeing, 454–455
 physical properties characterization, 455
- Modified flax fibre, 451–452
- Moisture absorption, 13, 150
- Moisture regain of modified cotton and linen fabrics, 462–463, 462t
- Moisturizers, 524–525
- Molecular biology, 692
 synthetic natural fibres via, 696–697
- Monoacylglycerol lipase (MAGL), 430
- Mordanting, 94
- Moulting, 126–127
- MRSA. *See* Methicillin-resistant *Staphylococcus aureus* (MRSA)
- MS. *See* Multiple sclerosis (MS)
- MS cotton. *See* Medium staple cotton (MS cotton)
- MTO. *See* Mineral turpentine oil (MTO)
- MTS. *See* Material Testing System (MTS)
- Mucor hiemalis*, 228
- Mucor stolonifer*, 228
- Muga silk, 128
 worm and cocoons, 129f
- Mulberry silk, 124. *See also*
 Non-mulberry silk
 global raw silk production, 125t
 types, 124
 worm and cocoons, 124f
- Mulching, 524
- Multi-end basin, 134–135, 134f
- Multi-functional finishes for jute fabric, 102
- Multi-scale mechanical characterization of flax, 208–220
 mechanical investigations on stems, 209–213
 bending tests on flax stems, 209–211
 bending tests to estimating fibre stiffness, 211–213
 nanomechanical investigations on flax cell walls, 219–220
 tensile behaviour of elementary flax fibres, 216–217
 tensile tests on flax fibre bundles, 213–216
- Multiple sclerosis (MS), 439
- Multivoltines, 126
- Murata Vortex spinning (MVS), 28
- Mussel silk, 129
- MVS. *See* Murata Vortex spinning (MVS)
- Myrcene, 568–569
- Myrobolan (Harda) powder, 94
- N**
- N-AEA. *See* N-Arachidoneethanolamine (N-AEA)
- N-CPC. *See* N-Cetyl pyridinium chloride (N-CPC)
- Nanochitosan, 665

- Nanoclays, 385
- Nanomechanical investigations on flax cell walls, 219–220
- AFM, 220
 - nanindentation, 219–220
- Nanoparticles (NPs), 659, 672–673
- of semiconductors, 667
- Nanosilver, 661
- Nanotechnology, 385
- NAPE-PLD. *See* N-Acyl
- phosphatidylethanolamine
 - phospholipase D (NAPE-PLD)
- Naringenin, 424
- Natural agents, 669–670, 674
- Natural bioactive agents on natural fibres, 669–670
- Natural biodegradable material, 621–622
- Natural dyes, 264–265, 666
- application on jute, 92–95
 - natural dyed textile goods, 93
- Natural fibre composites (NFCs), 469–470, 613–614
- for building and automotive industries, 488–494
 - green composites for automotive applications, 490–492
 - green composites for building materials, 488–490
 - structural NFC composites by z-axis fibre reinforcement, 492–494
- for construction and automotive industries, 469
- fundamentals of composite materials, 471–474
 - manufacturing methods, 480–484
 - composite processing techniques, 481t
 - RTM machine, 483f
 - various composite manufacturing methods, 482t
- natural fibre reinforcement forms for green composites, 477–480
 - quality assurance and testing, 484–488
- Natural fibre particle applications, 550–553.
- See also* Powder characterization
 - biomedical applications, 550–551
 - coating and printing, 552
 - coloured alpaca fibre and print, 552f
 - sorption applications, 550
 - 3D printing, 552–553
- Natural fibre powder production by milling, 532–541. *See also* Powder characterization
- challenges of milling natural fibres, 532–533
 - methods of milling natural fibres, 534–541
 - explosion risks of fibre powders, 540–541
 - media mills, 536–538
 - non-media mills, 535–536
- obtaining powder after wet milling, 539–540
 - process parameters in milling, 540
 - wet milling advantage of natural fibres, 538–539, 539f
- pre-treatments of natural fibres for milling, 533–534
- Natural fibres, 147, 169, 245, 500, 502, 507, 531
- advantages, 147–148
 - biomimetic inspired textiles using, 695
 - electrokinetic properties, 323–353
 - applications, 335–346
 - future trends, 346–347
 - key principles, 324–335
- enzymatic treatment, 227
 - future trends, 239
 - key principles, 227–234
 - main types, 234–239
- erosion control, 523
 - flame retardancy, 355–391
 - flammability and, 368–378
 - future trends, 384–386
 - key issues, 362–368
 - methods of improvement, 378–384
- functional requirements of geosynthetic materials, 504–507
 - functions and applications of geotextiles in civil engineering, 511–520
 - geosynthetic or synthetic geotextile used in separation, 514f
 - geotextile in filtration and drainage applications, 519f
 - geotextile on side of pond, 516f
 - geotextile tube for coastal protection, 517f

- Natural fibres (*Continued*)
- geotextiles as protection function, 513f
 - geotextiles in order to meet their performance, 512f
 - future, 525–526
 - geotextile
 - market size of, 503–504
 - in rural road construction, 523
 - improving properties by chemical treatments, 245–321
 - cotton, 288
 - future trends, 307
 - silk, 280–287
 - vegetable fibres, 305–306
 - wool, 246–280
 - moisturizers, 524–525
 - mulching, 524
 - natural bioactive agents on, 669–670
 - natural vegetable fibres for geotextiles and suitability, 500–501
 - for paper and packaging
 - agriculture residues and annual plants, 597–600
 - localisation of fibers in plant, 593t
 - new challenges for paper and board producers, 612–614
 - pulping and papermaking processes, 602–612
 - raw materials, 591–602
 - structure and ultrastructure of fibres, 600–602
 - wood fibres, 593–597
 - primary uses for geotextiles, 507–511
 - protection of earthquake, 525
 - reinforcement forms for green composites, 477–480
 - physical properties comparison, 478t
 - reinforcement of weak soil and materials, 521–522
 - types of synthetics geotextiles, 501–502
- Natural leather, 376–377
- Natural retting of flax, 237
- Natural rubber (NR), 645–646
- Natural rubber coated jute (NRcJ), 645–647
- Natural vegetable fibres, 500–501
- NCC. *See* Cellulose nanocrystals (NCC)
- NDT. *See* Nondestructive testing (NDT)
- Needle loop, 39, 40f
- Neem (*Azadirachta indica*), 669–670
- Nephila clavipes*, 121
- Nephila madagascariensis*, 130
- Neurospora crassa*, 231
- NFCs. *See* Natural fibre composites (NFCs)
- NFPA 68 (Explosion Venting Guide), 541
- NFT 25–501–2 standard, 212, 217
- (NH₄)₂HPO₄. *See* Diammonium phosphate (DAP)
- Nitration, 53–54
- Nitrocellulose, 689
- Nitrogen, 544
- Nodes, 598
- Non-durable chemical compounds, 378
- Non-flame process, 356
- Non-media mills. *See* Media mills
 - air jet mill, 535–536
 - cutter mill, 535
 - pan mill, 536
- Non-mulberry silk, 127–130, 143–144. *See also* Mulberry silk
 - Anaphe silk, 129
 - Coan silk, 129
 - Eri silk, 128
 - Fagara silk, 129
 - Muga silk, 128
 - Mussel silk, 129
 - Oak tasar, 127
 - Spider silk, 130
 - Tasar silk, 127
- Non-mulberry silkworms, 121
- Non-toxic (hydrocarbon free) batching oil use, 103
- Non-weighted silk, 282
- Non-wood fibres, 593
 - for pulp and papermaking, 610–612
 - smart packaging under development, 611t
- Non-woven reinforcement for composites, 177–180. *See also* Woven fabrics
 - manufacture for composites
 - formability potential of flax-nonwoven fabrics, 179–180
 - manufacturing processes, 178
 - mechanical properties of flax non-woven fabrics, 178–179
- Nondestructive testing (NDT), 44–45, 487
 - application, 44–45
- Nonfouling electrolytic membrane technology, 611–612

Nonkeratinous proteins of wool, 248
Nonwoven disposable fabrics, 657
11-Nor-9-carboxy-D9-tetrahydrocannabinol
(THC-COOH), 431
NPs. *See* Nanoparticles (NPs)
NR. *See* Natural rubber (NR)
NRcJ. *See* Natural rubber coated
 jute (NRcJ)
Nutraceuticals, 575
Nutrients in soil, 403
Nutritional effects of flax and hemp,
 563–569
 comparative nutrient profile of hemp and
 flax, 564t

O
OAC. *See* Olivetolic acid cyclase (OAC)
Oak tasar, 127
OECD. *See* Organization for Economic
 Cooperation and Development
 (OECD)
Official grades of American Upland cotton,
 23t
Oleaginous flax, 171–172
Olivetolic acid cyclase (OAC), 423
Omega-3 ALA, 561
Omega-6 fatty acids, 561–562
One Mack Looms, 71
Onion (*Allium cepa*), 669–670
OPECs. *See* Organic polymer engineering
 composites (OPECs)
Open-end rotor spinning,
 26–27, 27f
Opener machine, 141
OPTIM, 263–264
OPTIM Fine, 263–264
OPTIM Max, 264
Orb-weaving arachnids, 692
Organic chlorine compounds, 232
Organic polymer engineering composites
 (OPECs), 472
Organization for Economic Cooperation and
 Development (OECD), 621
Organzine, 139
Oriented Strand Board (OSB), 490
OSB. *See* Oriented Strand Board (OSB)
Osmium basilicum. *See* Tulsi leaves
 (*Osmium basilicum*)
Ovalization, 211

Oxidation
 of jute, 63–64
 metabolism, 238
 oxidative bleaching, 277
Oxide lime, 400
Oxidoreductases, 237

P
PA. *See* Polyamides (PA)
Pachypasa otus D, 129
Packaging textiles (Pack-tech), 50,
 107–108, 108t
Pad-steam method, 232
PAHs. *See* Polycyclic aromatic
 hydrocarbons (PAHs)
PAL. *See* Phenylalanine ammonia lyase
 (PAL)
PAMAM. *See* Poly(amidoamine)
 dendrimers (PAMAM)
Pan mill, 536
Papermaking process, 602–612
 challenges for paper and board producers,
 612–614
 damaged wood, 613
 invasive plants, 613
 smart functions, 613–614
 pressing and drying sections, 610
 sheet formation, 609–610
 sizing–coating–calendering, 610
 specificities of non-wood fibres for,
 610–612
 stock preparation, 608–609
Partial Photo stabilized bleaching of jute
 fabric, 76
Particle
 filled plastics, 470
 size and morphology, 541–543, 543f
 surface area of, 544–546
 surface energy of, 546
Partnership for Advancing Technology in
 Housing (PATH), 488
PAS. *See* Polyarylsulfone (PAS)
PATH. *See* Partnership for Advancing
 Technology in Housing (PATH)
PBDEs. *See* Polybrominated diphenyl ethers
 (PBDEs)
PBZ. *See* Phenylbutazone (PBZ)
PC. *See* Polycarbonate (PC)
PCA. *See* Process control agent (PCA)

- PCF. *See* Process Chlorine Free (PCF)
- PCL. *See* Polycaprolactone (PCL)
- pcr. *See* Point of charge reversal (pcr)
- PE. *See* Polyethylene (PE)
- Peak Force Quantitative Nano Measurement mode (PFQNM mode), 220
- Peak heat release rate (PHRR), 368–369
- Pectase, 236
- Pectin, 236
- Pectinases, 236–237
- Pectinolytic enzymes, 230
- Pectins, 57, 600–602
- PEEK. *See* Polyetheretherketone (PEEK)
- PEI. *See* Polyethyleneimines (PEI)
- Pellet diet, 131
- Pentosan, 54, 54f
- Peptide bonds, 246
- Peracetic acid, 256
- Perfluoroalkyls, 361
- Permethrin, 275–276, 275f
- Permonosulfuric acid (PMS), 254, 256, 259
- Peroxide method of bleaching, 232
- Peroxisome proliferator-activated receptors gamma (PPAR γ), 432
- Peroxyacid, 671
- Personal care, flax and hemp application in and, 573–581
- PET. *See* Polyethylene terephthalate (PET)
- PFQNM mode. *See* Peak Force Quantitative Nano Measurement mode (PFQNM mode)
- Phanerochaete chrysosporium*, 229–230
- PHAs. *See* Polyhydroxyalkanoates (PHAs)
- PHB. *See* Polyhydroxybutyrate (PHB)
- Phenolic amides, 426–427
occurring in *C. sativa*, 427f
synthesis, 427
- Phenolic compounds, 576
- Phenylalanine, 248, 424
- Phenylalanine ammonia lyase (PAL), 424
- Phenylbutazone (PBZ), 434–435
- Philosamia ricini*, 128
- Phloem, 593–595
- PHMB. *See* Poly(hexamethylene biguanide) (PHMB)
- Phosphatidylinositol-3-kinase (PI3K), 428
- Phosphorus–nitrogen synergism, 367
- Photo-stabilization of jute yarns and fabrics, 76–78
- Photo-yellowing
of bleached jute, 64
of silk, 286
- Photomicrobicidal agents, 673
- Photomicrobicidal materials, 667–669
- Photosynthesis, 591–593
- PHRR. *See* Peak heat release rate (PHRR)
- Phylisamia ricini* (eri), 121
- Phytocannabinoids, 422–423, 430. *See also*
Cannabinoids (CBD)
acid forms, 435–436
beneficial effect of, 437
effectiveness of medical treatment,
description of medical cases, 437–438
flavonoids, 436–437
pharmacodynamics
CBC, 434–435
CBD, 432–433
CBDV, 434
CBG, 434
CBN, 433–434
THC, 431–432
THCV, 435
pharmacologically active *Cannabis sativa*
preparations, 438–440
available preparations and use, 438–439
legal issues, 440
terpenoids, 436–437
- Phytoremediation, 395
- Phytosterols, 579
- PI3K. *See* Phosphatidylinositol-3-kinase (PI3K)
- Pigments, 97
printing of jute, 97, 105
- Pinna squamosa*, 129
- Pirm winding, 139
- PKS. *See* Polyketide synthase (PKS)
- PLA. *See* Polylactic acid (PLA)
- Plants, 591–593
fibres, 205
yields, 395–396
- Plasma, 245
technology, 661
- Pleurotus ostreatus*, 238
- PMA. *See* Poly(methacrylic acid) (PMA)
- PMS. *See* Permonosulfuric acid (PMS)
- Poil, 139
- Point of charge reversal (pcr), 334–335
- Point of zero charge (pzc), 334–335

- Polar gaseous probes, 546
- Poly(amidoamine) dendrimers
(PAMAM), 454
dendrimer, 455–456, 463
- Poly(hexamethylene biguanide)
(PHMB), 670
- Poly(methacrylic acid) (PMA), 662
- Poly(N-vinyl-2-pyrrolidone) with iodine
(PVP-I), 670–671
- Poly(propylene oxide), 258
- Polyamide-epichlorohydrin, 452–453
- Polyamides (PA), 474–475
- Polyarylsulfone (PAS), 474
- Polybrominated diphenyl ethers (PBDEs),
360–361
- Polycaprolactone (PCL), 553
- Polycarbonate (PC), 474
- Polycarboxylic acids, 284, 369–370
- Polycationic molecules, 664–665
- Polycyclic aromatic hydrocarbons
(PAHs), 413
- Polyester, 49–50
- Polyetheretherketone (PEEK), 474
- Polyethylene (PE), 474–476, 621–622
- Polyethylene terephthalate (PET), 474–475
- Polyethyleneimines (PEI), 662–663
- Polyhydroxyalkanoates (PHAs), 474
- Polyhydroxybutyrate (PHB), 476
- Polyketide synthase (PKS), 422
PKS III, 423
- Poly(lactic acid) (PLA), 474, 476, 553
- Polymer, 502, 662–663
composites, 472
grafting, 279–280
polymeric matrix, 475
- Polyolefin fibres, 49–50
- Polyolefins, 49–50
- Polyphenols, 566
- Polyphenylene sulfide (PPS), 474
- Polypropylene (PP), 49–50, 474–475, 553,
645–646
- Polystyrene (PS), 474–476, 695
- Polystyrene- β -(ethylene-co-butylene)- β -
styrene (SEBS), 695
- Polyunsaturated fatty acids (PUFAs), 575,
577
- Polyurethane (PU), 385
- Polyvinyl alcohol (PVA), 99, 385
- Polyvinyl chloride (PVC), 475–476
- Post-cocoon technology
cocoon cooking, 132
cocoon sorting, 132
cocoon stiffling, 132
- Potassium persulfate (KPS), 385
- Poured density, 547
- Powder characterization. *See also* Natural
fibre particle applications
biodegradation of fibre particles, 549
bulk and tapped density, 547
cohesion and flowability of powder,
548–549
compressibility of wool powder, 548f
particle size and morphology, 541–543,
543f
size and morphology of sub-micron
particles, 544
surface area of particles, 544–546
surface energy of particles, 546
- Powder rheometer, 548–549
- PP. *See* Polypropylene (PP)
- PPAR γ . *See* Peroxisome proliferator-
activated receptors gamma (PPAR γ)
- PPI dendrimer, 455–456
- PPS. *See* Polyphenylene sulfide (PPS)
- ‘Pre-flocked’ method, 493–494
- Pre-metallized dyes, 266–267
- Pre-seeded erosion control blanket (PsECB),
631–632
germinating seeds in, 633f
- Precleaning, 18
- Prefabricated vertical drain (PVD),
632–635
- Prehistoric humans fashioned clothing, 690
- Preparatory, 141–142
drafting principle, 141
drawing, 141
roving, 141
spreader, 141
twist, 142
- Pressing, 21, 610
- Prickly chaff flower (*Achyranthes aspera*),
669–670
- Printing, 552
eco friendly printing of jute, 105
of silk, 284–285
- Process Chlorine Free (PCF), 604–605
- Process control agent (PCA), 539–540
- Procion-H dye, 84–85

- Procion-HE dye, 84–85
 Procion-M dye, 84–85
 Programmatic breeding, 689
 Proteases, 237
 enzymes, 234
 Protective textiles (Pro-tech), 50,
 107–108, 109t
 Protein, 565–566, 600–602
 flax seed, 566
 hempseed, 566
 profile of flax and hempseeds, 562–563
 soiling, 339–340
 Protein fibres, 286–287, 372–375
 chitosan effects, 665
 fibre blends with wool, 375
 QAC effects, 664
 silk, 372–373
 silver effects, 662
 wool, 373–374
 Zirpro flame retardant treatments,
 374–375
 Proteinaceous fibres, 40
 Proteobacteria, 410
 α -Proteobacteria, 408
 β -Proteobacteria, 408
 Protopectinase, 236
 PS. *See* Polystyrene (PS)
 PsECB. *See* Pre-seeded erosion control
 blanket (PsECB)
Pseudomonas aeruginosa, 654
 PU. *See* Polyurethane (PU)
 PUFAs. *See* Polyunsaturated fatty acids
 (PUFAs)
 Pulping, 602–607
 bleaching, 604–605
 chemical, 604
 physical properties of kraft and bisulfite
 pulp, 604t
 mechanical, 602–603
 main characteristics, 603t
 new challenges for paper and board
 producers, 612–614
 damaged wood, 613
 invasive plants, 613
 smart functions, 613–614
 production of MFC and NCC, 606–607
 specificities of non-wood fibres for,
 610–612
 steam explosion, 606

 Pulpmakers, 600
 Pultrusion, 481, 489–490
 Pure silk. *See* Non-weighted silk
 Purl stitch, 40, 41f
 PVA. *See* Polyvinyl alcohol (PVA)
 PVC. *See* Polyvinyl chloride (PVC)
 PVD. *See* Prefabricated vertical drain (PVD)
 PVP-I. *See* Poly(N-vinyl-2-pyrrolidone)
 with iodine (PVP-I)
 Pyrovatex CP, 369–370
 Pyrovatex CP New, 369–370
Pythium debaryanum, 228
 pzc. *See* Point of zero charge (pzc)
- Q**
- Quality assessment of nursery seedlings, 643
 Quality assurance and testing, 484–488
 flammability testing, 487–488
 flexural properties, 485–486
 impact/toughness properties, 486
 NDT, 487
 tensile test, 484–485
 Quaternary ammonium chloride, 665
 Quaternary ammonium compounds (QACs),
 659, 662–664, 673
 Quinine oxidoreductases (CBQ), 238
- R**
- Ramie (*Boehmeria nivea*), 228
 Randomly orientated flax stems, 171–175
 Rapid prototyping processes, 694
 Raw jute fibres, 67
 Raw wool, 246
 Rayon, 695
 RC-AFM. *See* Resonant contact-AFM
 (RC-AFM)
 Reactive dye application on jute, 84–86
 Reactive dyes of cotton, 266–267, 299–301
 Recombinant DNA, 692, 696
 RECP. *See* Rolled erosion control products
 (RECP)
 Recultivation method of polluted lands,
 398–402
 Reductive bleaching of wool, 277
 Reeling, 143
 operations, 131
 technology, 133–135
 automatic reeling, 135, 136f
 cottage basin, 134, 134f

- country charka, 133–134, 133f
 multi-end basin, 134–135, 134f
 waste, 140
- Regenerable agents, 671
- Reinforcement, 507, 510–511
 geosynthetic or synthetic geotextile in road
 stabilization, 510f
 of weak soil and materials, 521–522, 522f
- Relative humidity (RH), 273
- Remediation method of polluted lands,
 398–402
- Resin transfer moulding (RTM), 170,
 471, 481
- Resonant contact-AFM (RC-AFM), 220
- Retting degree, 215
- RH. *See* Relative humidity (RH)
- Rhizobium, 408
- Rhizopus artocarp*, 228
- Rhizopus chinensis*, 228
- Rhizopus nigricans*, 228
- Rhizopus tricii*, 228
- Ring spinning, 25–26, 26f
- Risks of antimicrobial finishing, 672–673
- Robust natural fibres, 632–633
- Rolled erosion control products (RECP),
 512–514
- Rot resistant property, 100
- Rotary knife gin principle, 17f, 19
- Rotational moulding, 483
- Roving, 25, 141
- RTM. *See* Resin transfer moulding (RTM)
- Rubber toughened plastics, 470
- ‘Rule of Mixtures’ model, 478–479
- S**
- S4A, 71
- Sacking, 69
- Sand drains, 632–633
- Sandospace DPE, 270–271
- Sandospace R, 270–271
- Sapling bag, 641–642
- Sapwood, 593–595
- Savinase, 233
- Savinase 16L, 234
- Saw gins, 17f, 18
 standard nominal capacities, 19
- Saw lint cleaner, 19–20
- SBD. *See* Stem base diameter (SBD)
- Scanning electron microscopy (SEM), 215,
 229–230
- Sclerotinia cinerea*, 228
- Sclerotium rolfsii*, 234
- Scouring, 232
 of cotton, 289–290
 Eco friendly scouring of jute, 104
 of jute, 75–76
- ‘Scoop’, 286
- Scutched long flax, 149
- Scutching, 175–176
- SDA. *See* Stearidonic acid (SDA)
- SDC. *See* Society of dyers and colourists
 (SDC)
- SEA. *See* Specific extinction area (SEA)
- SEBS. *See* Polystyrene- β -(ethylene-co-
 butylene)- β -styrene (SEBS)
- Section warp, 33
- Sediments control, 511
- SEM. *See* Scanning electron microscopy
 (SEM)
- Semiconductors role in antimicrobial
 activity, 667
- Sequestering agents, 277
- SER. *See* Spray enzyme retting (SER)
- Seric bave, 121
- Sericin, 121–122
 amino acid composition, 123t
- Sericulture, 130–131
 artificial feeding of silkworm larvae,
 130–131
- SH. *See* Stem height (SH)
- Shaker mills, 536
- Shear plane, 325–326
- Sheet formation, 609–610
- Sheet moulding compounds (SMC), 480
- Sheet pressing ability, 610
- Short fibre content, 11
- Short flax for carded yarns, 149
- Short staple cotton (SS cotton), 21
- Shrink-resist treatments, 254–257
- Shuttle less weaving, 72–74
- Shuttle loom, 72
- Silicone, 66, 258
 jute treatment with, 66
- Silk, 121–123, 148, 237, 280–287,
 696–697. *See also* Cotton
 (*Gossypium* spp.)

Silk (*Continued*)

amino acid composition of fibroin and sericin, 123t
 bleaching, 284
 chemical and physical structure, 280–281
 amino acid composition of silk fibroin and silk sericin, 282t
 scanning electron micrograph (SEM) of raw silk, 281f
 cross-linking and grafting treatments, 283–284
 degumming, 233
 dyeing and printing, 284–285
 fabric manufacture, 136–139
 doubling, 138
 pirn winding, 139
 soaking of silk, 138
 stages, 137–139, 137f
 twisting, 138–139
 types of twisted yarn, 139
 warping, 139
 winding, 138
 future trends in natural silk production, 143–144
 industry, 130–131
 reeling operations, 131
 sericulture, 130–131
 silk yarns production, 131
 particles, 551, 551f
 photoyellowing, 286
 place of origin
 Chinese races, 126
 European races, 126
 Indian races, 125
 Japanese races, 125–126
 post-cocoon technology
 cocoon cooking, 132
 cocoon sorting, 132
 cocoon stifling, 132
 prints, 285
 protein fibres, 286–287, 372–373
 reeling technology, 133–135
 automatic reeling, 135, 136f
 cottage basin, 134, 134f
 country charka, 133–134, 133f
 multi-end basin, 134–135, 134f
 sericin, 669–670
 spun silk production
 degumming of waste silk, 140

 dressing or combing, 141
 finishing, 142–143
 preparatory, 141–142
 spinning, 142
 waste classification, 140
 structure, 122f
 treatment with acid and alkali, 285–286
 types and importance, 124–130
 mulberry silk, 124
 non-mulberry silk, 127–130
 voltinism, 126–127
 weighting, 281–283
 Silk fabric manufacture, 16
 Silkworm (*Bombyx mori*), 121, 124, 130, 280–281, 669–670
 fibres, 121
 silk of, 122–123
 Silver, 660–662, 673
 NPs, 662
 Simultaneous dyeing, 101–102
 Singeing of cotton, 289–290
 Sinker loop, 39, 40f
 SIPs. *See* Structural insulated panels (SIPs)
 Siro spinning, 27, 28f
 Sirolan LTD Process, 271
 Siroset Process, 262
 Sizing, 610. *See also* Desizing
 of weaving, 34
 Skewness test of fabric, 44
 Skin, 672
 other flax components relevant for skin care, 576–577
 flax mucilage gums, 576–577
 phenolic compounds and tocopherols, 576
 other hemp compounds, 579–580
 traditional uses of flax and hemp, 574–575
 Slack mercerization, 290
 Slenderness of flax, 207–208
 Smart functions, 613–614
 Smart packaging under development, 611, 611t
 SMC. *See* Sheet moulding compounds (SMC)
 Smoke abatement technology, 385
 Snippets production, 535
 Soaking of silk, 138
 Soap and soda boil method, 140
 Society of dyers and colourists (SDC), 81

- Sodium chlorite, 232
- Sodium hydrosulfite ($\text{Na}_2\text{S}_2\text{O}_4$), 277, 302
- Sodium hydroxide (NaOH). *See* Caustic soda
- Sodium hypochlorite, 232
- Sodium silicate, 277, 289–290
- Sodium sulfide, 302
- Sodium sulphate, 271
- Sodium sulphite (Na_2S), 604
- Soft keratins, 248
- Softening
- eco friendly softening of jute, 103
 - of jute-based fabrics, 97
- Softwood fibres, 591–593, 595–596
- chemical fibres, 608–609
 - fibre width and cell wall thickness of, 595t
- Soil
- degradation, 395, 400
 - fertility, 398
 - microorganisms, 398
 - overburden, 395
- Soil-forming processes, 397
- Soil-geotextile system, 510
- Solar energy, 698
- Sol–gel
- methods, 386, 661
 - processing, 371
- Sorption applications, 550
- Specific extinction area (SEA), 376–377
- Specificity, 216–217
- Spider silk, 122, 130
- Spinnerets, 131
- Spinning, 142, 659
- of jute yarns, 67–69
 - processibility of chemically treated/modified jute fibres, 68–69
 - spinning process for making jute yarns, 67
 - yarn making from jute fibres, 68
- Spray drying, 539–540
- of colloidal slurry, 544
 - size distribution plots of wool during, 542f
 - spray dried particles from sub-micron bead mill dispersion, 545f
- Spray enzyme retting (SER), 229
- Spreader, 141
- Spun silk production
- degumming of waste silk, 140
 - dressing or combing, 141
 - finishing, 142–143
 - preparatory, 141–142
 - spinning, 142
 - waste classification, 140
- SRIM. *See* Structural reaction injection moulding (SRIM)
- SS cotton. *See* Short staple cotton (SS cotton)
- St-1, 541
- Stability of flax, 207–208
- Stabilized bleaching of jute, 64–65
- Stabilizers, 277
- Stannic oxide, 381
- Staphylococcus aureus*, 579, 654, 659
- STB Process, 98
- Steam explosion, 606
- Steam stifling, 132
- Steaming, 139
- Stearidonic acid (SDA), 561–562
- Steel reinforced concrete, 470
- Stem base diameter (SBD), 643
- Stem bending stiffness EI, 210
- Stem height (SH), 643
- Stifling, 131
- Stilbenoids, 425
- synthesis, 425
- Stirred media mills, 537–538
- Stitch, 40
- Stock preparation, 608–609
- Stone mill. *See* Pan mill
- ‘Stone-washed’ effect, 232
- Stoving, 131
- Streaming potential
- coupling coefficient, 330
 - method, 339–340
- Strength, yarn, 31
- Stress–strain curve of single flax fibre, 217, 218f
- Stretchability of linen, 150–152
- Structural insulated panels (SIPs), 488
- Structural NFC composites, 492–494
- Structural reaction injection moulding (SRIM), 480–481, 491–492
- Structural reversal, 9
- Sub-micron air jet milled silk particles, 549
- Sub-micron particles
- production, 544
 - size and morphology of, 544
- Sub-micron particles production, 544

- Suint, 246
- Sulfamethoxazole, 671
- Sulphur dyes, 301–302
application on jute, 90–92
- Sun drying, 132
- Sunn hemp (*Crotalaria juncea*), 228
- Super absorbent coir mat, 639–641
- Superfine melt technology, 385
- Supermilling dyes, 266–267
- Suspension tests, 660
- Synthetic dyes, 266–267, 666
- Synthetic fibre
biomimetic inspired textiles using, 694–695
blends, 161–162
- Synthetic natural fibres via molecular biology, 696–697
- Synthetic non-biodegradable material, 621–622
- Synthetics geotextiles type, 501–502
geotextile structures, 501f
- Syzygium aromaticum*. See Clove oil
(*Syzygium aromaticum*)
- T**
- Tamarind Kernel Powder (TKP), 74, 103
- Tanned leather, 375
- Tannic acid–metal ion, 661
- Tapped density, 547
- Tasar silk, 127, 143–144
worm and cocoons, 127f
- TCF. See Totally chlorine free (TCF)
- Tea tree (*Melaleuca alternifolia*), 669–670
- Tearing strength test of fabric, 43
- TEM. See Transmission electron microscopy (TEM)
- Temperature/ironing, 152
- TEMPO. See 2,2,6,6-Tetramethyl-piperidin-1-oxyl (TEMPO)
- Tencel blended yarns, 155
- Tensile behaviour of elementary flax fibres, 216–217
AFM PF-QNM modulus mapping, 219f
fibre morphology and diameter measurement on tensile properties calculation, 216–217
- Tensile strength, 151
and elongation test of fabric, 40
of modified cotton and linen fabrics, 458–460, 461t
- Tensile tests, 215, 484–485
elementary fibre cohesion evaluation within bundle, 215–216
on flax fibre bundles, 213–216
choice of pertinent parameters, 213–215
cross-section diameter measure on tensile behaviour of flax bundles, 213–214
gauge length, 214–215, 214f
- Terminalia arjuna*. See Arjun
(*Terminalia arjuna*)
- Terminalia tomentosa*. See Asna
(*Terminalia tomentosa*)
- Terpenes, 423–424, 568–569
characteristics of most common, 423–424
- Terpenoids, 423–424, 436–437
beneficial effect of, 437
characteristics of most common, 423–424
- Terry fabrics, 36–37
- Terry towel, 36–37
basics of terry weaving, 37, 37f
classification, 38
- Terry toweling, 36
- Tetrahydrocannabinol (THC), 419, 422–423, 567, 579
- Tetrahydrocannabinol acid (THC-A), 431–432, 434–436, 567
- Tetrahydrocannabivarin (THCV), 422–423, 435, 568
- Tetrakis-(hydroxymethyl)-phosphonium chloride (THPC), 50–52, 105, 369
- 2,2,6,6-Tetramethyl-piperidin-1-oxyl (TEMPO), 607
- Texam BFE, 230
- Textile materials, 690
biomimetics and, 689–700
future trends, 697–698
key principles and issues of biomimetic inspired textiles, 694–697
key principles of biomimesis, 691–694
nature as model for textile materials, 689–691

- Textiles, 65, 156
 architecture techniques for 2D and 3D fabrics, 187–188
 composite reinforcement, 176–190
 diversified end uses of jute as technical textiles, 106–111, 107f
 fibres for reasonable blends, 154–155
 flax, 171–176
 hazards, 653–654
 and microbial hazards, 653–654
 biodegradation of natural fibres, 653
 everyday products, 654
 infectious diseases, 653
 as protection against biohazards and as infection reservoirs, 656–658
 reinforcement, 478
 world textile fibre consumption, 3
- TGA. *See* Thermogravimetric analysis (TGA)
- THC. *See* Tetrahydrocannabinol (THC)
- THC-A. *See* Tetrahydrocannabinol acid (THC-A)
- THCV. *See* Tetrahydrocannabivarin (THCV)
- Thermogravimetric analysis (TGA), 553
- Thermoplastic imides (TPIs), 474
- Thermoplastics, 471–472
 derived from renewable sources, 477f
 polymers, 483
- Thermosets, 471–472
- Thiol group, 664
- THPC. *See* Tetrakis-(hydroxymethyl)-phosphonium chloride (THPC)
- THPOH-based fire retardant agents, 105
- Thread waste, 140
- Three-point bending test of flax stem, 209–211, 210f
 experimental parameters, 211
- Three-point loading system, 486
- 3D printing, 552–553
- 3D structures by moulding
- Throwing, 131
- THT. *See* Tyramine hydroxycinnamoyltransferase (THT)
- Time to sustained ignition (TI), 376–377
- Tin-phosphate-silicate process, 282–283
- Titanium dioxide (TiO₂), 661
- Titration method, 323
- TKP. *See* Tamarind Kernel Powder (TKP)
- TMM. *See* Trimethylol melamine (TMM)
- Tocopherols, 566, 576
- Topsoil, 393
- 'Tossa' jute. *See* *Corchorus olitorius*
- Totally chlorine free (TCF), 604–605
- Tow buckling, 170
- TPIs. *See* Thermoplastic imides (TPIs)
- Tracheids, 595–596
- Tram, 139
- N-Trans-caffeoyltyramine, 427
- N-Transferuloyltyramine, 427
- Transient receptor potential cation channel, subfamily A (TRPA1), 432, 434–435
- Transmission electron microscopy (TEM), 282–283
- Transportable natural grass lawn, 644–645
- Transversal section, 593–595
- Travellette-type croissure, 134
- 2,4,4'-Trichloro-2'-hydroxydiphenyl ether, 670
- Trichoderma*, 234
- Trichoderma reesei*, 228
- Trichoderma viride*, 228
- Triclosan, 670, 673
- Trigonelline, 426
- Trimethoprim, 671
- Trimethylol melamine (TMM), 284, 293, 371
- TRM. *See* Turf reinforcing mats, or matrices, (TRM)
- TRPA1. *See* Transient receptor potential cation channel, subfamily A (TRPA1)
- Tuck, 40
- Tulsi leaves (*Osmium basilicum*), 669–670
- Turf reinforcing mats, or matrices, (TRM), 514
- Turk fabric. *See* Terry toweling
- Turkish terry. *See* Terry toweling
- Turkish toweling. *See* Terry toweling
- Twist, 142
 multiplier, 31
 yarn, 31
- Twisted yarns, 181
- Twisting, 138–139
- Two Mack Looms, 71
- Tyramine, 426
- Tyramine hydroxycinnamoyltransferase (THT), 427

U

- U.S. Adopted Name (USAN), 439
 Ultimates, 67, 305
 Ultrafine particles, 531–532, 539, 541–542.
 See also Natural fibre powder
 production by milling; Powder
 characterization
 coloured particles, 552
 high surface effect, 550
 jet milled particles, 547
 milling natural fibre into, 534–535
 sub-micron particles, 549
 Ultrafine powders, 536–537
 Ultrasonic
 environment in flax fibre dyeing, 451–452
 treatment of hemp, 611
 Ultraviolet (UV), 492
 light, 277, 654
 Union fabric products, 27–28
 Universal HVI Calibration cotton, 22–23
 Universal HVI Cotton Color and Cotton
 Trash Standards, 22–23
 Universal HVI Micronaire Calibration
 cotton, 22–23
 Universal standards, 22
 Univoltines, 126
 Unsaturated polyester, 451–452
 Uronic acid, 54
 US Consumer Product Safety Council
 (CPSC), 378
 US Environmental Protection Agency
 (EPA), 362
 USAN. *See* U.S. Adopted Name (USAN)
 Uster CLASSIMAT. *See* Classification of
 yarn faults (Uster CLASSIMAT)
 Uster hairiness, 32
 Uster HVI, 13
 UV. *See* Ultraviolet (UV)

V

- Vacuum infusion process (VI process), 494
 fabrication process, 492–493
 Vacuumassisted resin transfer moulding
 (VARTM), 490
 Valine, 248
 Valsol LTA, 271, 275–276
 Vancomycin-resistant enterococci,
 655–656
 ‘Vanya’ silk products, 143–144

- Varietal selection, 207
 Vat dyes, 301–302
 application on jute, 86–90
 Vatting, 301
 Vegetable fibres, 305–306
 acetylation and cyanoethylation, 306
 cross-linking, 306
 mercerization, 305–306
 Vertical burn test, 488
Vigna angularis. *See* Adzuki beans
 (*Vigna angularis*)
 Vinyl triethoxy silane (VTS), 341–342
 Viscozyme, 230
 Voltinism, 126–127
- W
- Warp knitting, 39
 Warp yarns, 69–72
 Warping, 32–33, 139
 direct warp, 33
 section warp, 33
 Waste from cocoons, 140
 Water repellent, 102
 property, 100–101
 Water-insoluble chitosans, 664–665
 Waterproof jute packaging, 645–647
 three bowl calendaring, 646f
 Waxes in jute, 56
 Weave, 69–71
 Weaving
 fabrics, 35–36
 grey fabric inspection, 36
 leasing, knotting and drawing, 34
 process, 35–36
 sizing, 34
 warping, 32–33
 woven fabric, 32
- Weft
 knitting, 39
 winding, 50–52
 yarns, 69–71
 Weighting of silk, 281–283
 Wet milling
 advantage of natural fibres,
 538–539, 539f
 obtaining powder after, 539–540
 size distribution plots of wool during, 542f
 Wet processing techniques, 245
 ‘Wet’ flocked method, 493–494

- Wheat, 598
- White hepatica (*Chenopodium album* L.), 400
- White rot fungi, 229–230
- ‘White’ jute. *See Corchorus capsularis*
- WHO. *See* World Health Organization (WHO)
- Winding, 138
- Wood fibres, 593–597
- hardwood fibres, 596–597
 - softwood fibres, 595–596
- Wood/plastic composite (WPC), 489
- Wool, 148, 237, 246–280
- abrasion resistance improvement, 272
 - bleaching, 277
 - dyeing, 264–272
 - acid levelling dye structure, 266f
 - bromoacylamido reactive dye structure, 268f
 - fibre damage in processing and dyeing, 271–272
 - fibre structure effect on, 268–271
 - metal complex dyes structure, 268f
 - natural dyes, 264–265
 - synthetic dyes, 266–267
 - fabric, 662
 - felting and shrinkproofing, 253–261
 - chemical treatment plus polymer:bath treatments, 258–259
 - continuous treatment of wool top, 259–260
 - DCCA sodium salt structure, 255f
 - disulphide bonds oxidation followed by bisulphite, 256f
 - environmental issues of chlorination in wool shrinkproofing, 260–261
 - felting shrinkage, 253–254
 - Hercosett 125 chemical structure, 259f
 - polymer treatments, 257–258
 - polymer-only treatments, 258
 - shrink-resist treatments, 254–257
 - fibres, 666
 - modification, 233–234
 - grease, 246
 - insect resistance, 275–276
 - permethrin chemical structure, 275f
 - physical and chemical structure, 246–252
 - amino acid composition, 247t
 - amphoteric nature, 250f
 - covalent and non-covalent interactions, 249f
 - scanning electron micrograph of merino wool fibre, 250f
 - schematic diagram of cortical cells within merino wool fibre, 252f
 - schematic diagram of merino wool fibre, 251f
 - polymer grafting, 279–280
 - protein fibres, 373–374
 - setting, 261–264
 - lanthionine and lysinoalanine cross-links formation, 262f
 - OPTIM, 263–264
 - thiol-disulfide interchange reaction involved in permanent setting of wool, 261f
 - wool and Optim cross-section, 263f
 - treatments to reduce yellowing, 277–279
 - sulfonated 2-hydroxyphenyl benzotriazole chemical structure, 278f
 - wrinkling and wrinkle recovery, 272–275
- Woolenization, 62
- World Health Organization (WHO), 567–568
- Woven fabrics manufacture for composites. *See also* Non-woven reinforcement for composites
- deformability of reinforcement textiles, 188–190
 - manufacture of different families of yarns, 181–187
 - textile architecturation techniques for 2D and 3D fabrics, 187–188
- Woven Geojute, 631–632
- WPC. *See* Wood/plastic composite (WPC)
- WR of wool. *See* Wrinkle recovery of wool (WR of wool)
- WRA. *See* Wrinkle recovery angle (WRA)
- Wrap spun yarn, 183
- Wrinkle recovery angle (WRA), 452–453
- for modified and unmodified cotton fabrics, 457–458, 457f
 - for the modified and unmodified linen fabrics, 458f
- Wrinkle recovery of wool (WR of wool), 272–275
- Wrinkling of wool, 272–275

X

X-ray radiography, 487
Xanthation, 53–54
Xylan. *See* Pentosan
Xylanases, 227
Xylem, 593–595
Xyloglucans, 600–602
Xylose, 54

Y

Yarn, 23
 elongation, 31
 hank/fabrics, 85
 nippiness, 31
 slippage test, 44
 strength, 31, 181
 warp, 69–72
Yarn testing, 30–32
 Uster CLASSIMAT, 32
 yarn count ‘yarn linear density’, 30–31
 yarn evenness, 31

 yarn friction, 32
 yarn hairiness, 32
 yarn imperfections, 31
 yarn twist, 31
Yield factor, 631–632
Young’s modulus, 194, 478–479, 690
Yuneri diet, 131

Z

Z-axis fibre reinforcement
 structural NFC composites by, 492–494
 woven glass fabric, 493f
Zeta potential
 of fibres, 324–325
 of natural fibres, 330–335
Zinc, 357
ZIRPRO flame retardant treatments,
 374–375

Handbook of Natural Fibres

Volume 2: Processing and Applications

Provides fundamental discussions on a wide range of fibres, covering the latest processing practice and industrial applications.

The *Handbook of Natural Fibres* covers every aspect of natural fibres, their breeding, cultivation, processing and application over two volumes. This volume, *Processing and Applications*, provides detailed coverage of the latest processing techniques and industrial applications of a wide range of natural fibres.

Natural fibrous resources, both lignocellulosic and protein ones, are renewable, biodegradable and nontoxic, making them an important source of sustainable textile solutions, as well as providing special properties to many other kinds of product. A broad range of sources of natural fibres are covered in this book, including cotton, bast fibres: jute, flax, hemp, coir and silk.

A wealth of expertise is compiled in this book to provide a uniquely detailed reference for the processing, modification such as enzymatic and chemical treatment, flame retardancy, modification by amine-terminated dendritic polymers, characterization, selection and all manner of application of natural fibres and natural resources, including medical potential of hemp products and the role of bast plants in remediation of degraded lands.

Key Features

- Connects natural fibres and derived composites to a wide range of industrial applications in industries including textile, geotextile, construction, automotive, packaging and medical;
- Helps readers to appraise natural fibres on the basis of their mechanical, electrokinetic, antimicrobial or flame retardant qualities;
- Provides a rare glimpse of emerging manufacturing methods for silk.

About the editors

Professor Ryszard M. Kozłowski is an award-winning former Director of the Institute of Natural Fibres (for 34 years), Poznań, Poland. He is an Honorary Fellow of the Textile Institute, the Editor-in-Chief of the Journal of Natural Fibres, a former Scientific Advisor to the Institute for Engineering of Polymer Materials and Dyes, and the *Professor Honoris Causa* of the Pontifical Catholic University of Ibarra, Ecuador. Professor Kozłowski is also the Coordinator of both ESCORENA (the European System of Cooperative Research Networks in Agriculture), created by FAO, and the FAO/ESCORENA European Cooperative Research Network on Flax and other Bast Plants. He is the author/co-author of over 300 publications, including 26 books and 25 patents. The performer of domestic and international projects, an expert of the European Commission, a member of American Chemical Society and ICOMOS.

Mrs. Maria Mackiewicz-Talarczyk (MSc., Eng.) works as a scientific assistant at the Institute of Natural Fibres and Medicinal Plants for 30 years, a daughter of Dr. Zinaida Mackiewicz – one of the co-founders of this institute, which is celebrating 90 years of its activity in 2020. Acts as the Secretary of both ESCORENA Focal Point and the FAO/ESCORENA European Cooperative Research Network on Flax and other Bast Plants, such as hemp, jute, kenaf, ramie and alike. A co-author of book chapters and papers, an associate editor of the Journal of Natural Fibres.

Related titles

Sustainable Apparel, Blackburn, 2015, 9781782423393, Woodhead

Natural Dyes for Textiles, Vankar, 2017, 9780081012741, Woodhead

Advances in 3D Textiles, Chen, 2015, 9781782422143, Woodhead

Principles of Colour and Appearance Measurement, Choudhury, 2014, 9780857092298, Woodhead



WP

WOODHEAD
PUBLISHING

An imprint of Elsevier
elsevier.com/books-and-journals



ISBN 978-0-12-818782-1



9 780128 187821